



US00D687473S

(12) **United States Design Patent**
Edwards et al.

(10) **Patent No.:** **US D687,473 S**

(45) **Date of Patent:** **** Aug. 6, 2013**

(54) **REINFORCED EQUIPMENT PAD**

(75) Inventors: **Mark J. Edwards**, Spring, TX (US);
Kelly Patterson, Parker, CO (US);
Jackson D. Bishop, Castle Rock, CO
(US); **Gregory T. Barner**, Fresno, CA
(US)

(73) Assignee: **Oldcastle Precast, Inc.**, Auburn, WA
(US)

(**) Term: **14 Years**

(21) Appl. No.: **29/412,085**

(22) Filed: **Jan. 30, 2012**

(51) **LOC (9) Cl.** **15-09**

(52) **U.S. Cl.**
USPC **D15/141**

(58) **Field of Classification Search**
USPC D25/199; D8/354, 374; D15/141,
D15/199; 248/346.01, 346.02, 346.5, 678,
248/637

See application file for complete search history.

(56) **References Cited**

U.S. PATENT DOCUMENTS

5,209,968	A	5/1993	Sweeney	
5,268,226	A	12/1993	Sweeney	
5,664,394	A	9/1997	Sweeney	
5,728,458	A	3/1998	Sweeney	
5,895,025	A *	4/1999	Alesi et al.	248/678
6,927,183	B1	8/2005	Christen	
6,931,822	B1	8/2005	Christen	
7,334,421	B1 *	2/2008	Cantolino et al.	62/259.1
D575,313	S *	8/2008	Hull et al.	D15/141
D608,917	S *	1/2010	Ward et al.	D25/199
D617,582	S *	6/2010	Zalewski	D6/491
7,780,140	B1	8/2010	Ward et al.	

FOREIGN PATENT DOCUMENTS

WO	WO 93/01931	2/1993
WO	WO 93/01933	2/1993
WO	WO 96/31341	10/1996

* cited by examiner

Primary Examiner — Doris Clark

(74) *Attorney, Agent, or Firm* — Sheridan Ross P.C.

(57) **CLAIM**

The ornamental design for a reinforced equipment pad, as shown and described.

DESCRIPTION

FIG. 1 is a front perspective view of a reinforced equipment pad;
 FIG. 2 is a front elevation view thereof;
 FIG. 3 is a rear elevation view thereof;
 FIG. 4 is a right elevation view thereof;
 FIG. 5 is a left elevation view thereof;
 FIG. 6 is a top plan view of thereof;
 FIG. 7 is bottom plan view thereof;
 FIG. 8 is a bottom plan view of an alternative embodiment of the reinforced equipment pad shown in FIGS. 1-7;
 FIG. 9 is a front perspective view of a reinforced equipment pad according to an alternative embodiment;
 FIG. 10 is a front elevation view thereof;
 FIG. 11 is a rear elevation view thereof;
 FIG. 12 is a right elevation view thereof;
 FIG. 13 is a left elevation view thereof;
 FIG. 14 is a top plan view of thereof;
 FIG. 15 is bottom plan view thereof;
 FIG. 16 is a bottom plan view of an alternative embodiment of the reinforced equipment pad shown in FIGS. 9-15;
 FIG. 17 is a front perspective view of a reinforced equipment pad according to an alternative embodiment;
 FIG. 18 is a front elevation view thereof;
 FIG. 19 is a rear elevation view thereof;
 FIG. 20 is a right elevation view thereof;
 FIG. 21 is a left elevation view thereof;
 FIG. 22 is a top plan view of thereof;
 FIG. 23 is bottom plan view thereof;
 FIG. 24 is a bottom plan view of an alternative embodiment of the reinforced equipment pad shown in FIGS. 17-23;
 FIG. 25 is a front perspective view of a reinforced equipment pad according to an alternative embodiment;
 FIG. 26 is a front elevation view thereof;
 FIG. 27 is a rear elevation view thereof;
 FIG. 28 is a right elevation view thereof;
 FIG. 29 is a left elevation view thereof;
 FIG. 30 is a top plan view of thereof;
 FIG. 31 is bottom plan view thereof;
 FIG. 32 is a bottom plan view of an alternative embodiment of the reinforced equipment pad shown in FIGS. 25-31;

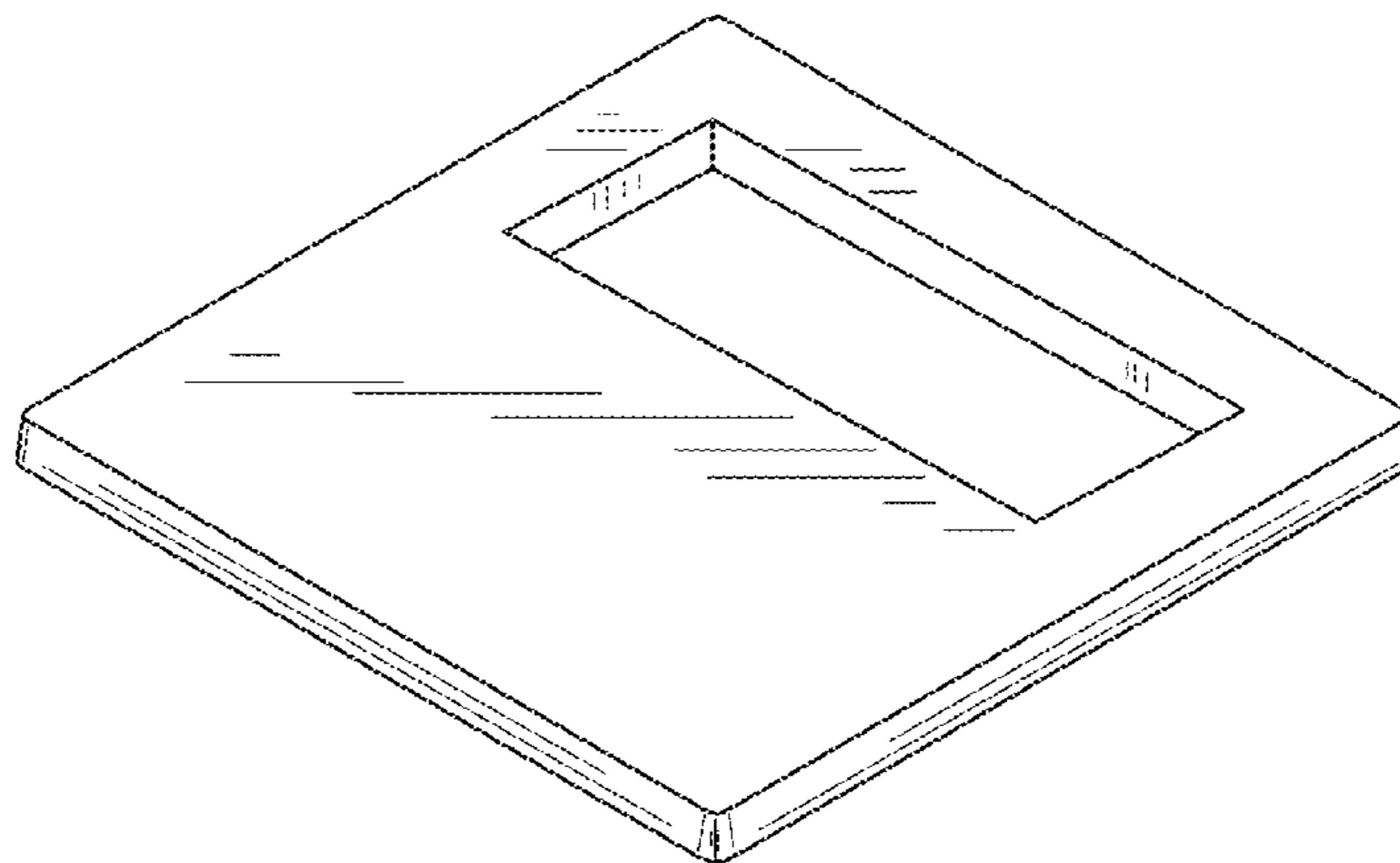

FIG. **33** is a front perspective view of a reinforced equipment pad according to an alternative embodiment;
FIG. **34** is a front elevation view thereof;
FIG. **35** is a rear elevation view thereof;
FIG. **36** is a right elevation view thereof;
FIG. **37** is a left elevation view thereof;
FIG. **38** is a top plan view of thereof;
FIG. **39** is bottom plan view thereof;
FIG. **40** is a bottom plan view of an alternative embodiment of the reinforced equipment pad shown in FIGS. **33-39**;
FIG. **41** is a front perspective view of a reinforced equipment pad according to an alternative embodiment;

FIG. **42** is a front elevation view thereof;
FIG. **43** is a rear elevation view thereof;
FIG. **44** is a right elevation view thereof;
FIG. **45** is a left elevation view thereof;
FIG. **46** is a top plan view of thereof;
FIG. **47** is bottom plan view thereof; and,
FIG. **48** is a bottom plan view of an alternative embodiment of the reinforced equipment pad shown in FIGS. **41-47**.

1 Claim, 21 Drawing Sheets

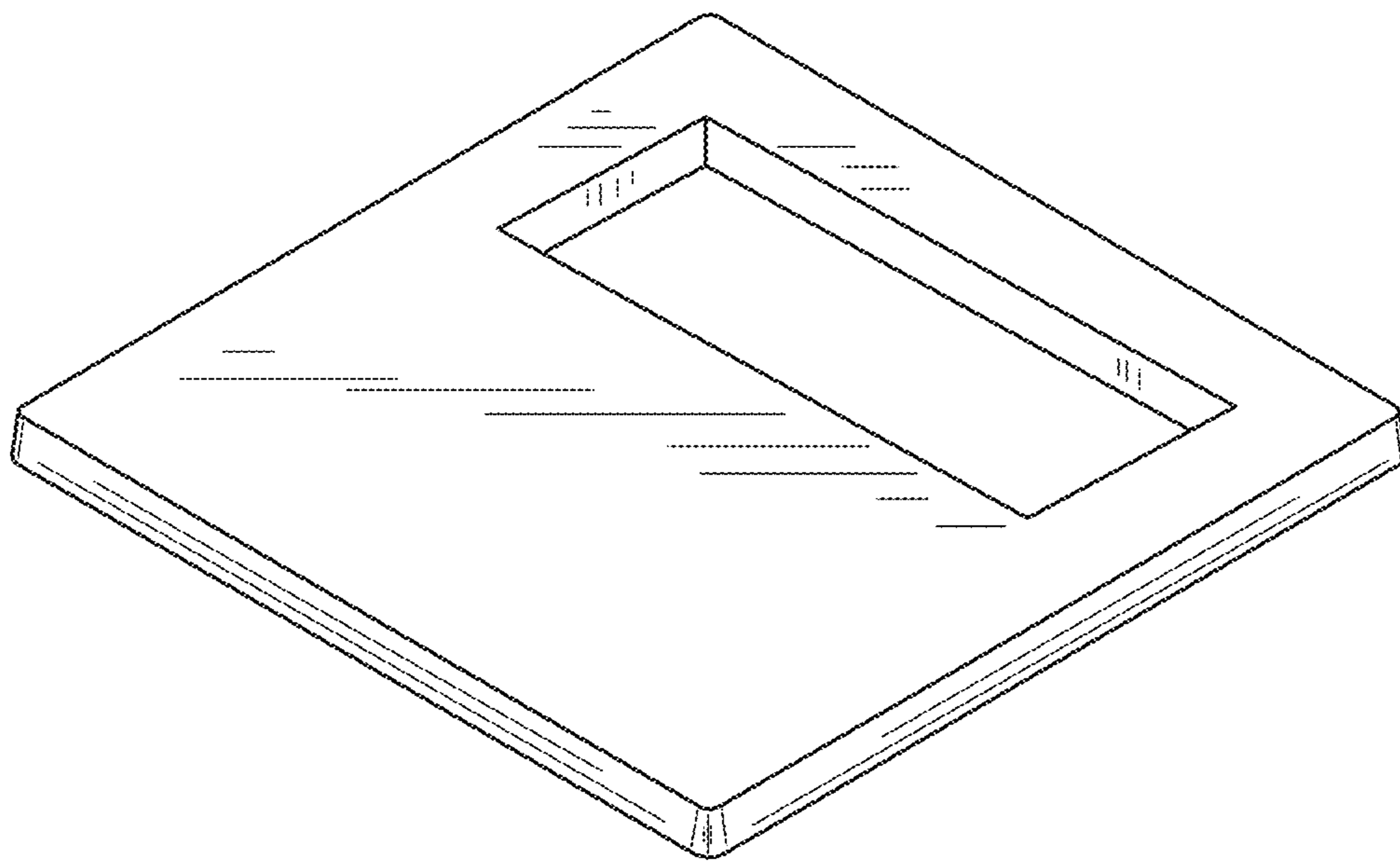

FIG.1



FIG. 5

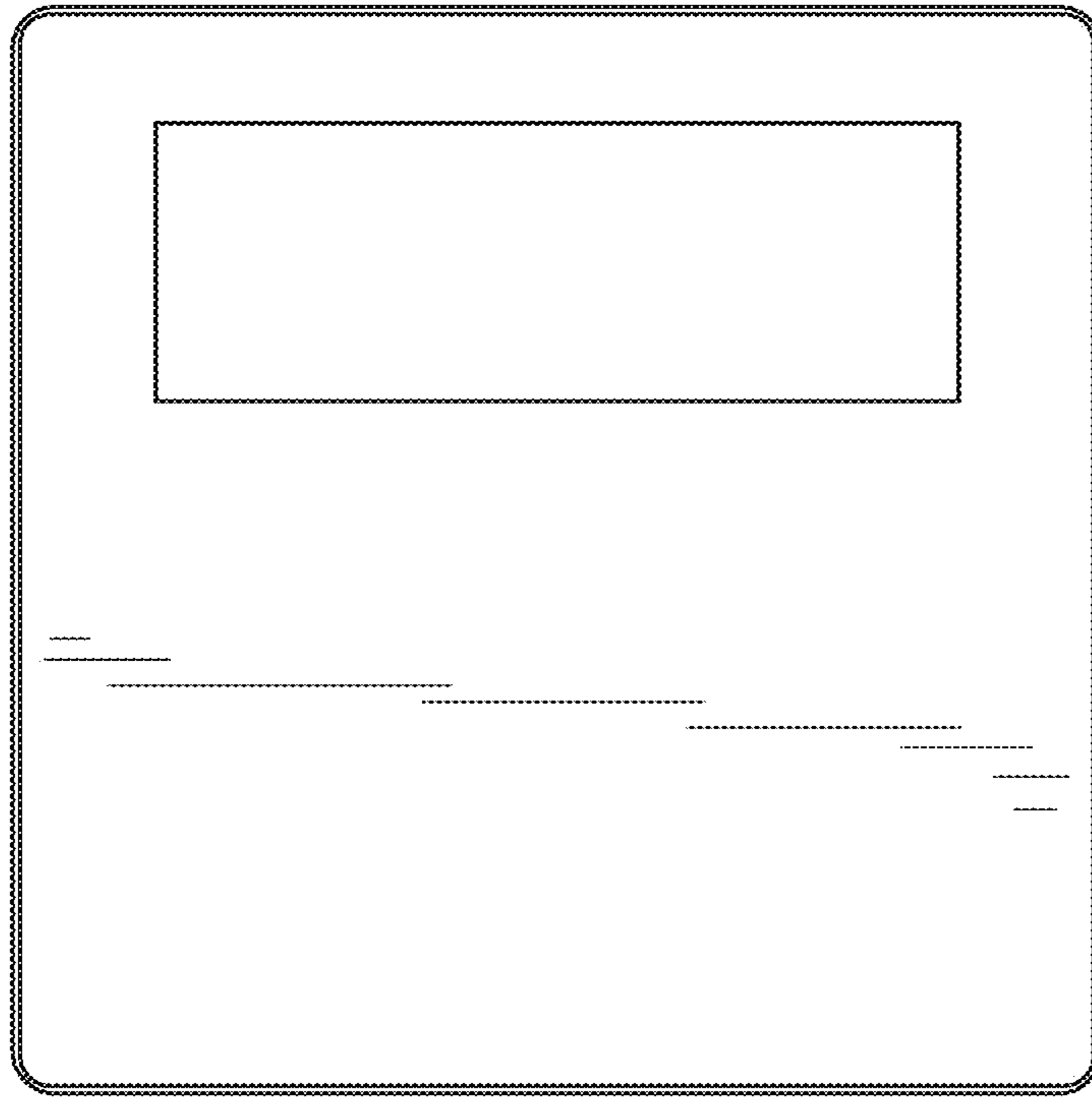

FIG. 6

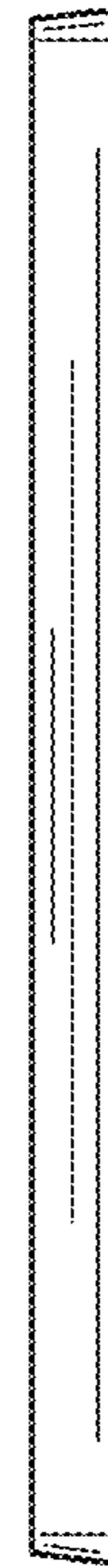

FIG. 4

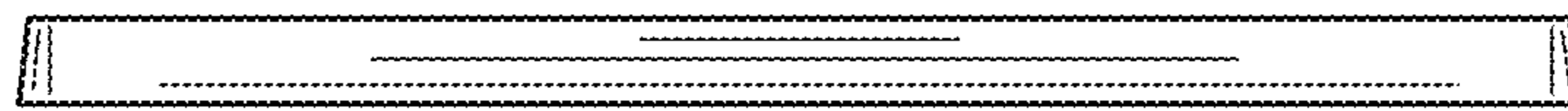

FIG. 2

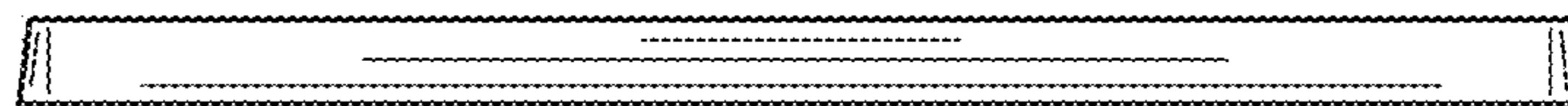

FIG. 3

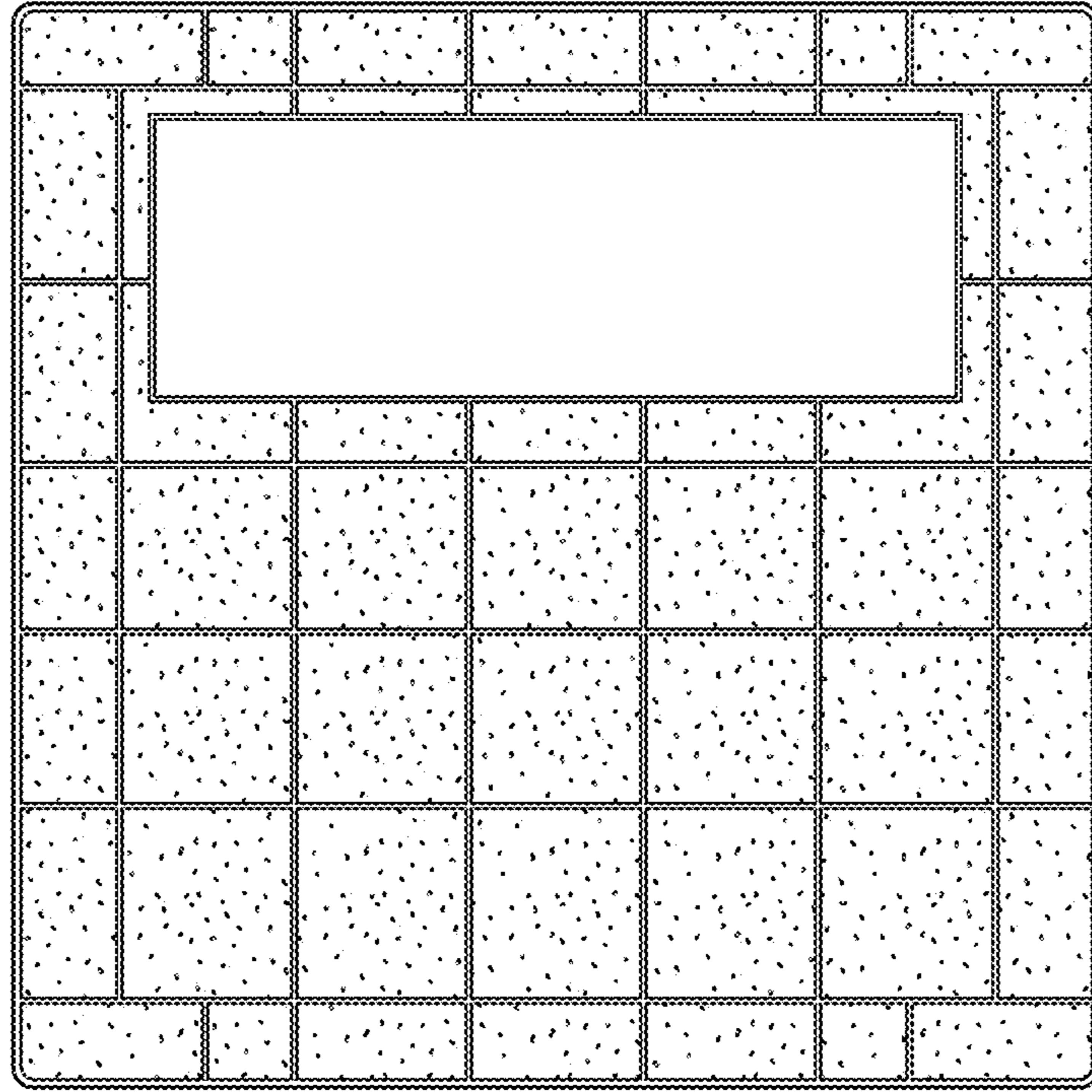

FIG. 7

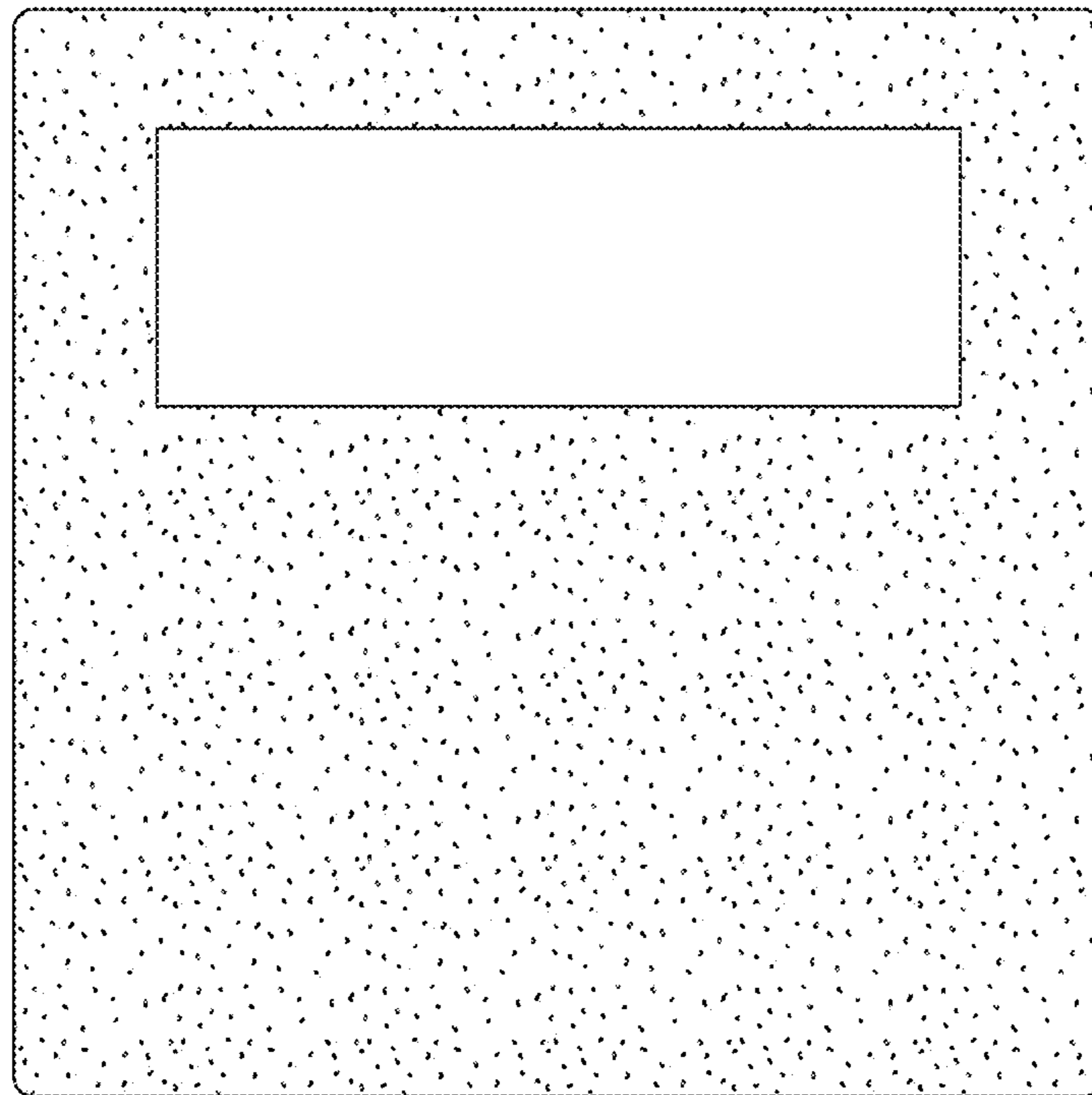

FIG. 8

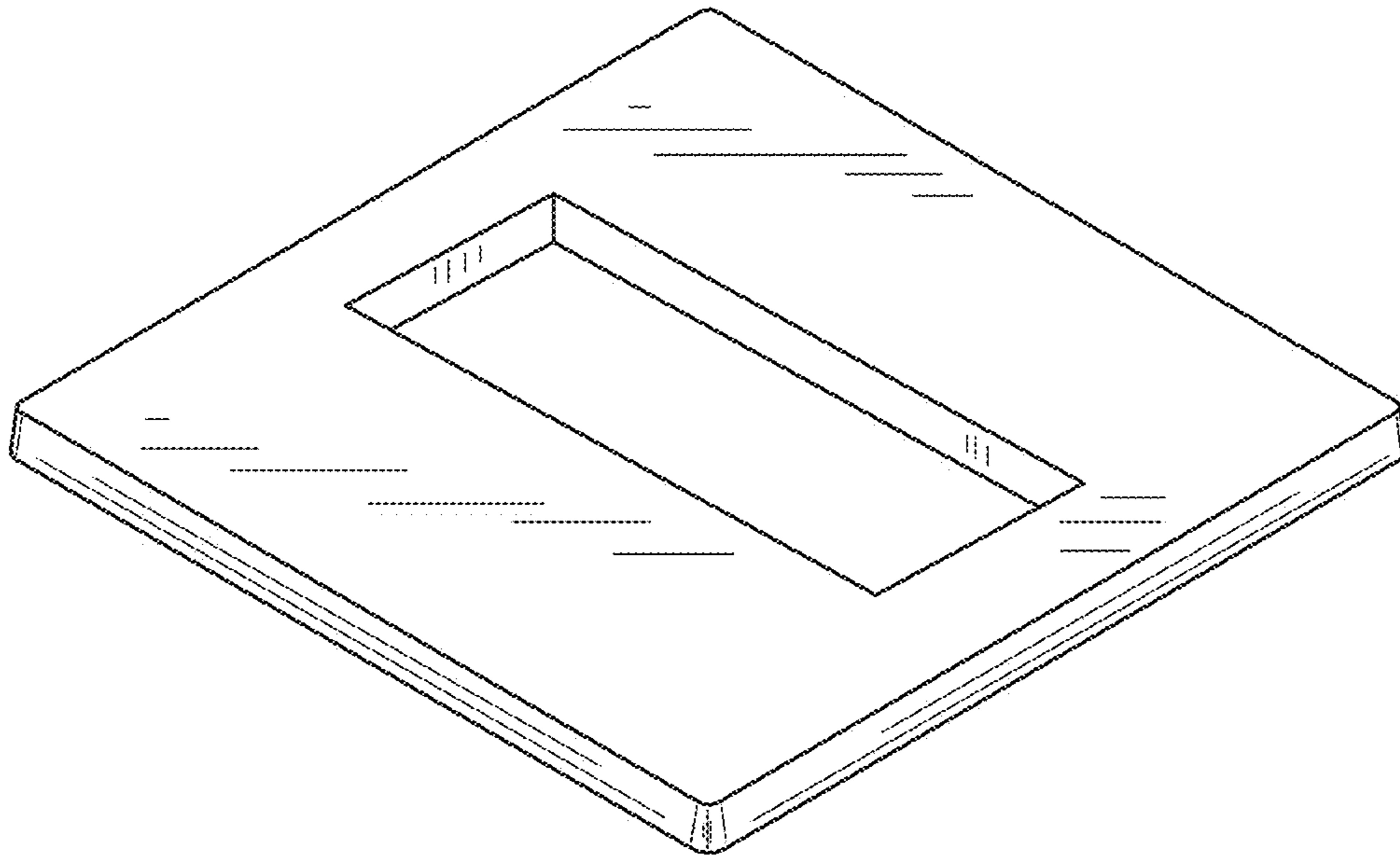

FIG.9

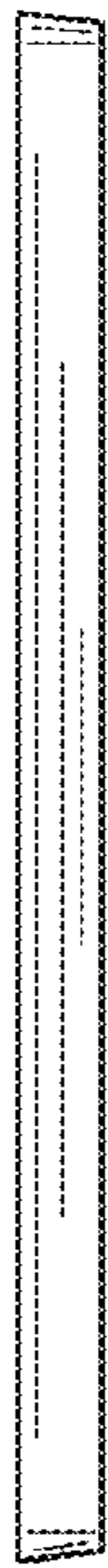

FIG. 13

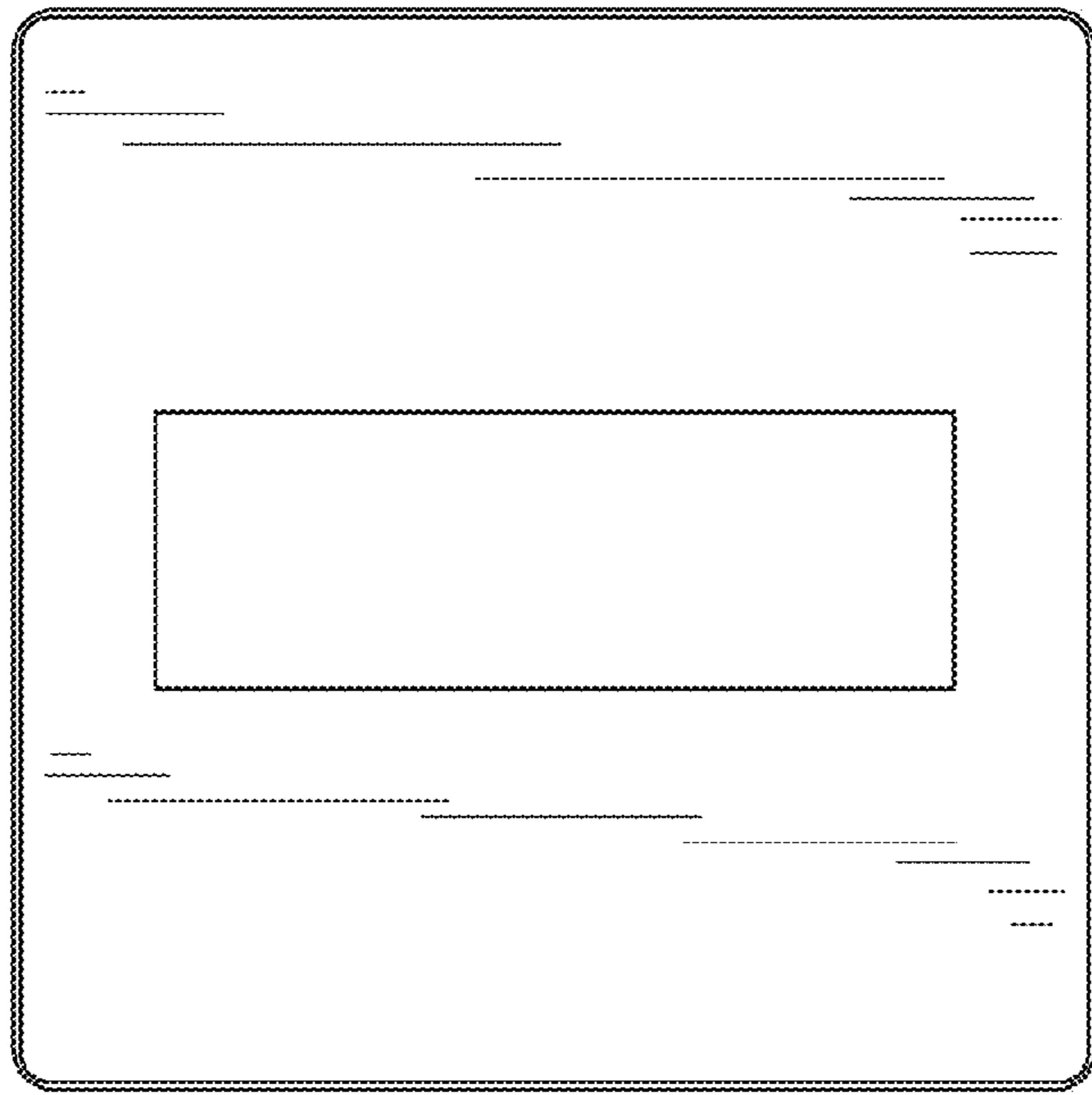

FIG. 14

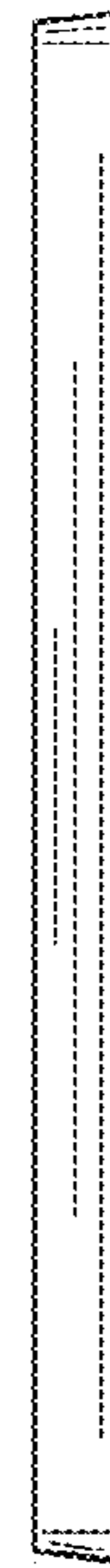

FIG. 12

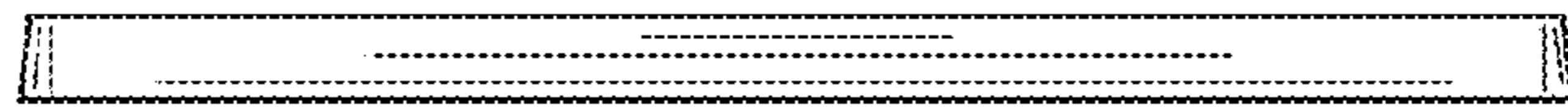

FIG. 10

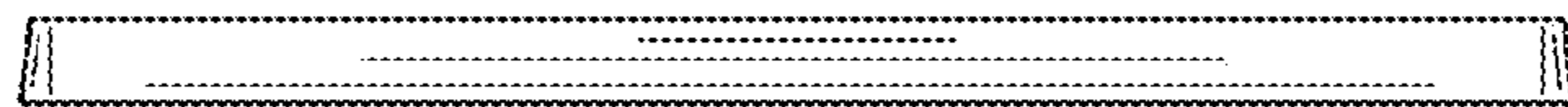

FIG. 11

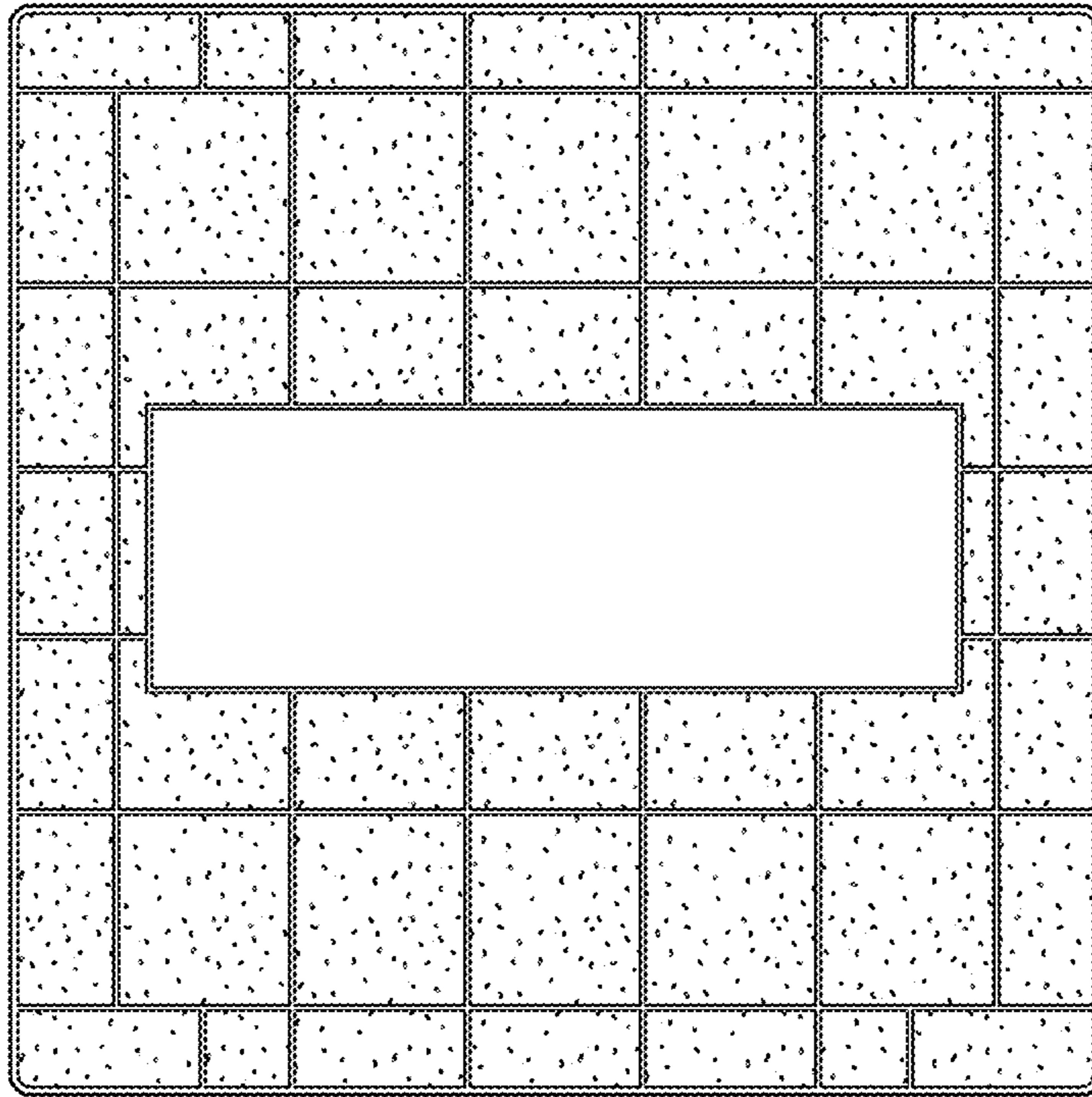

FIG. 15

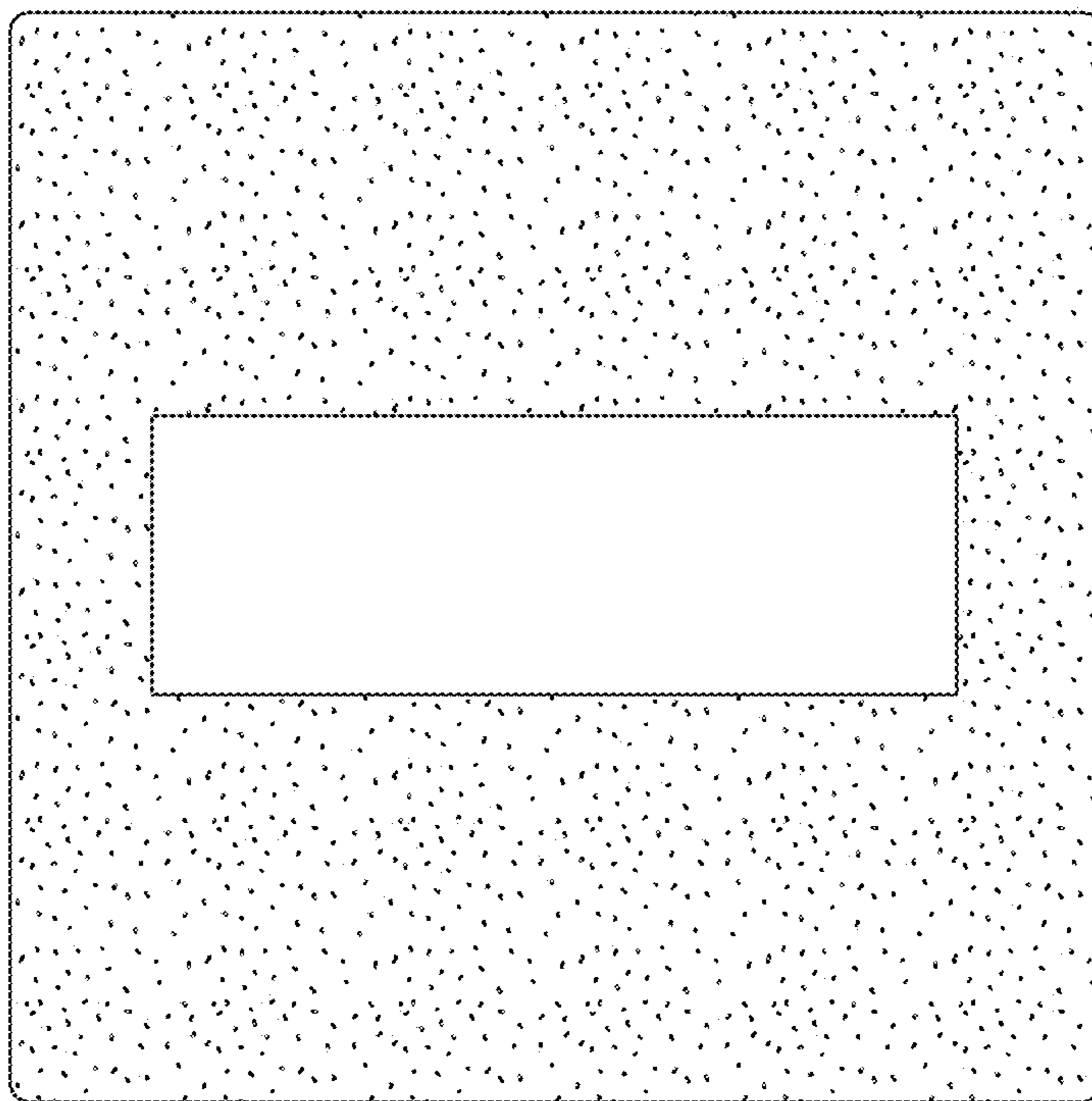

FIG. 16

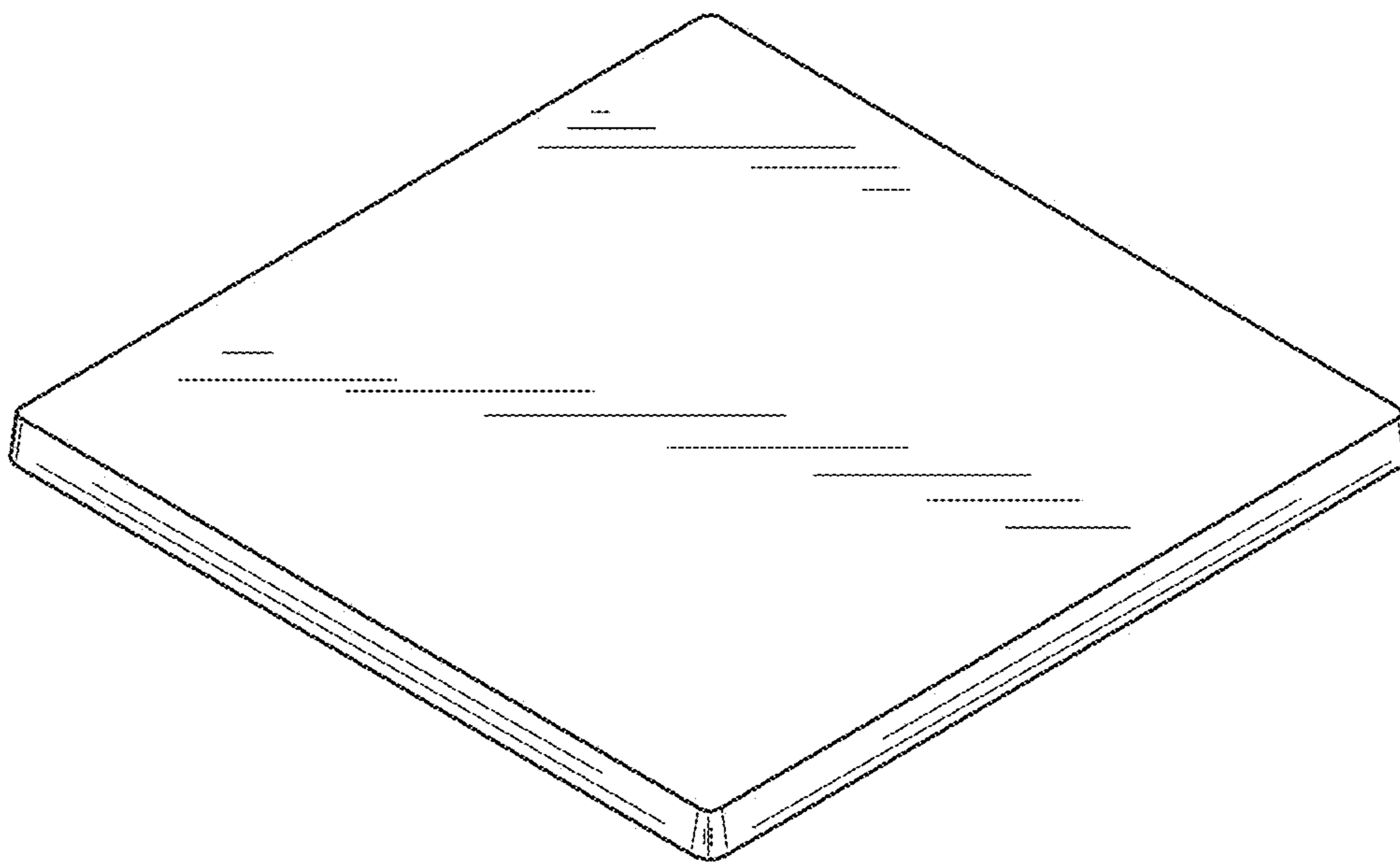

FIG.17

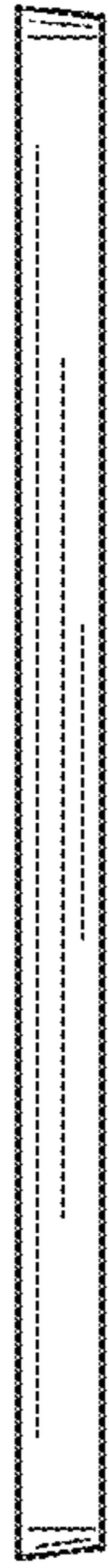

FIG. 21

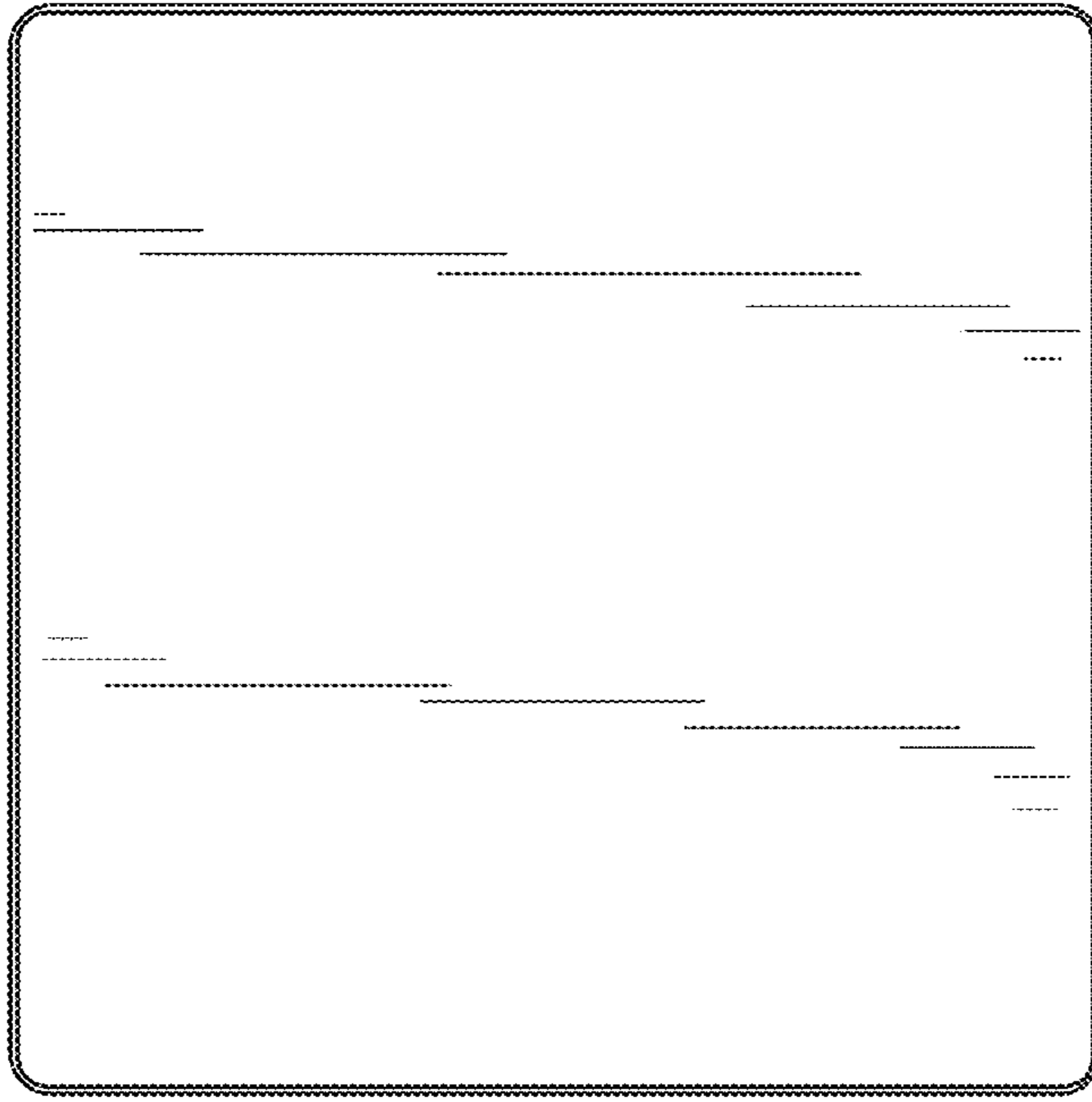

FIG. 22

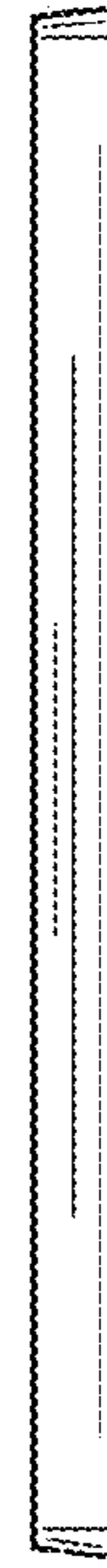

FIG. 20

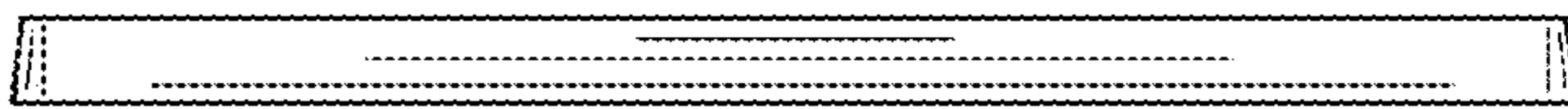

FIG. 18

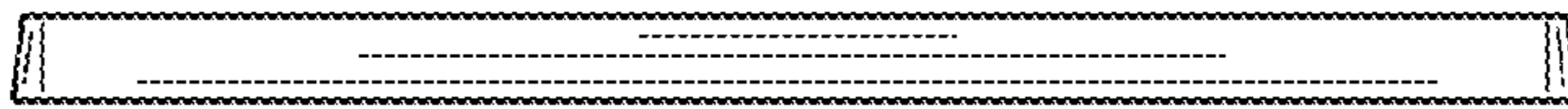

FIG. 19

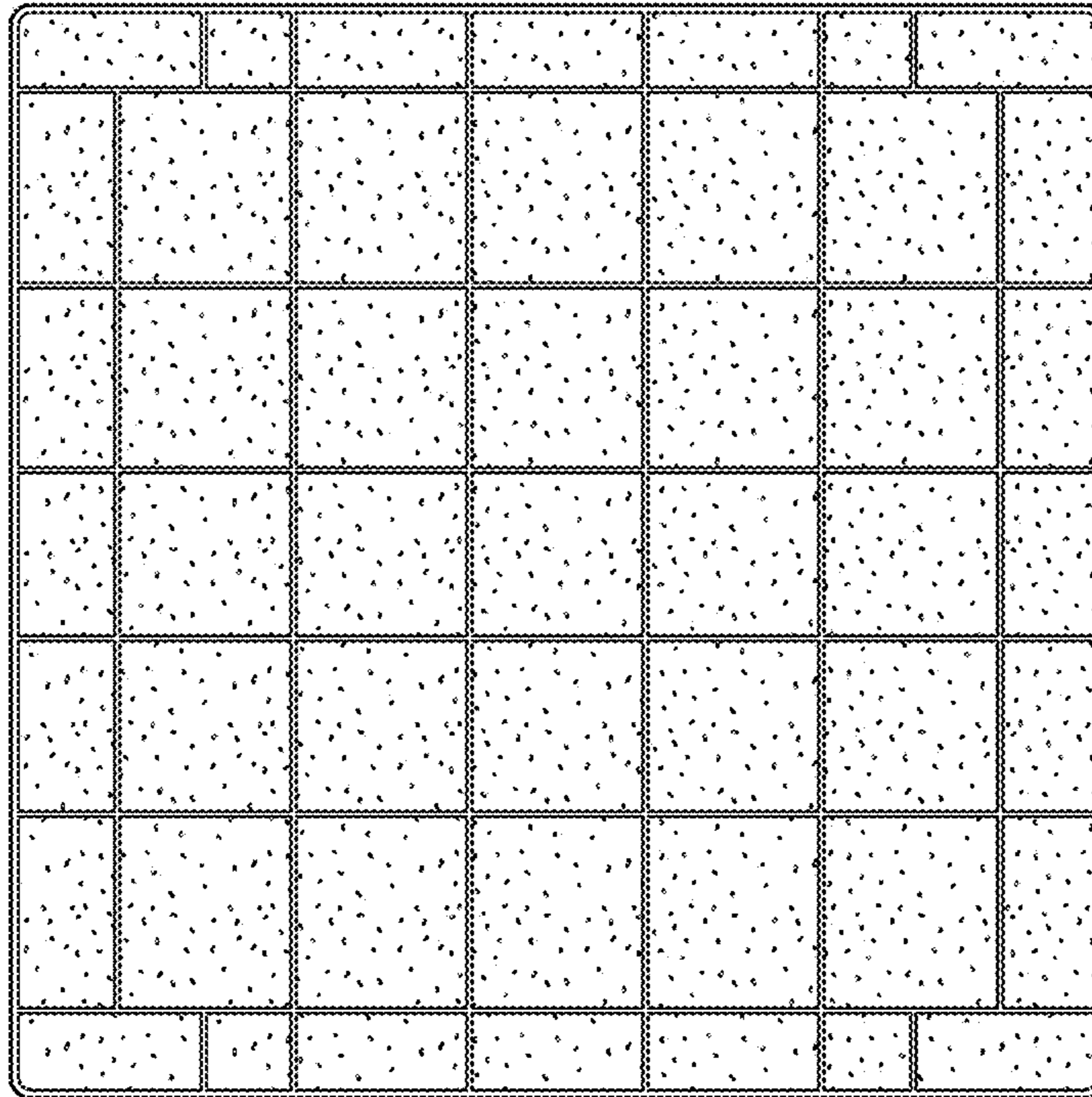

FIG.23

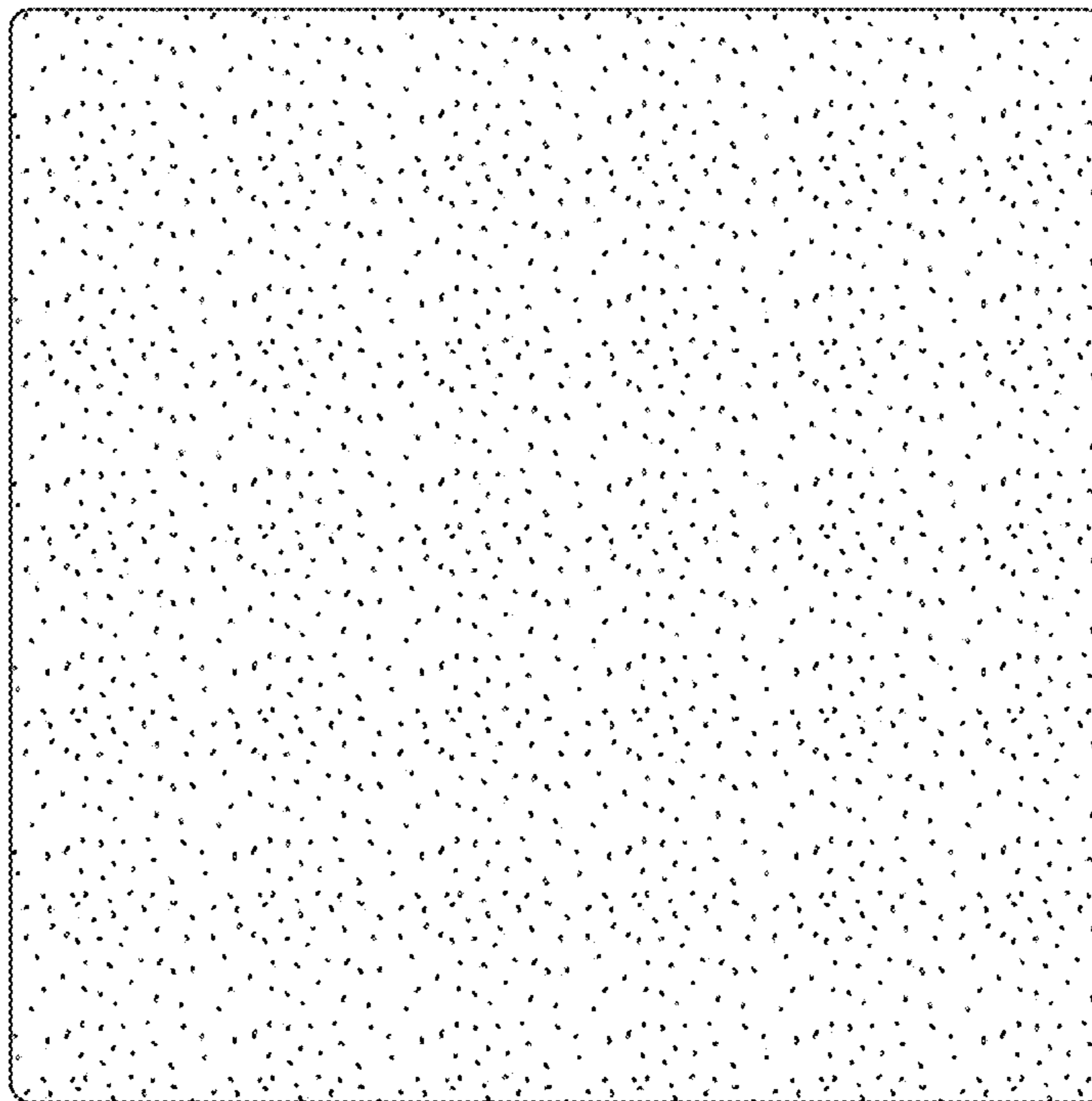

FIG.24

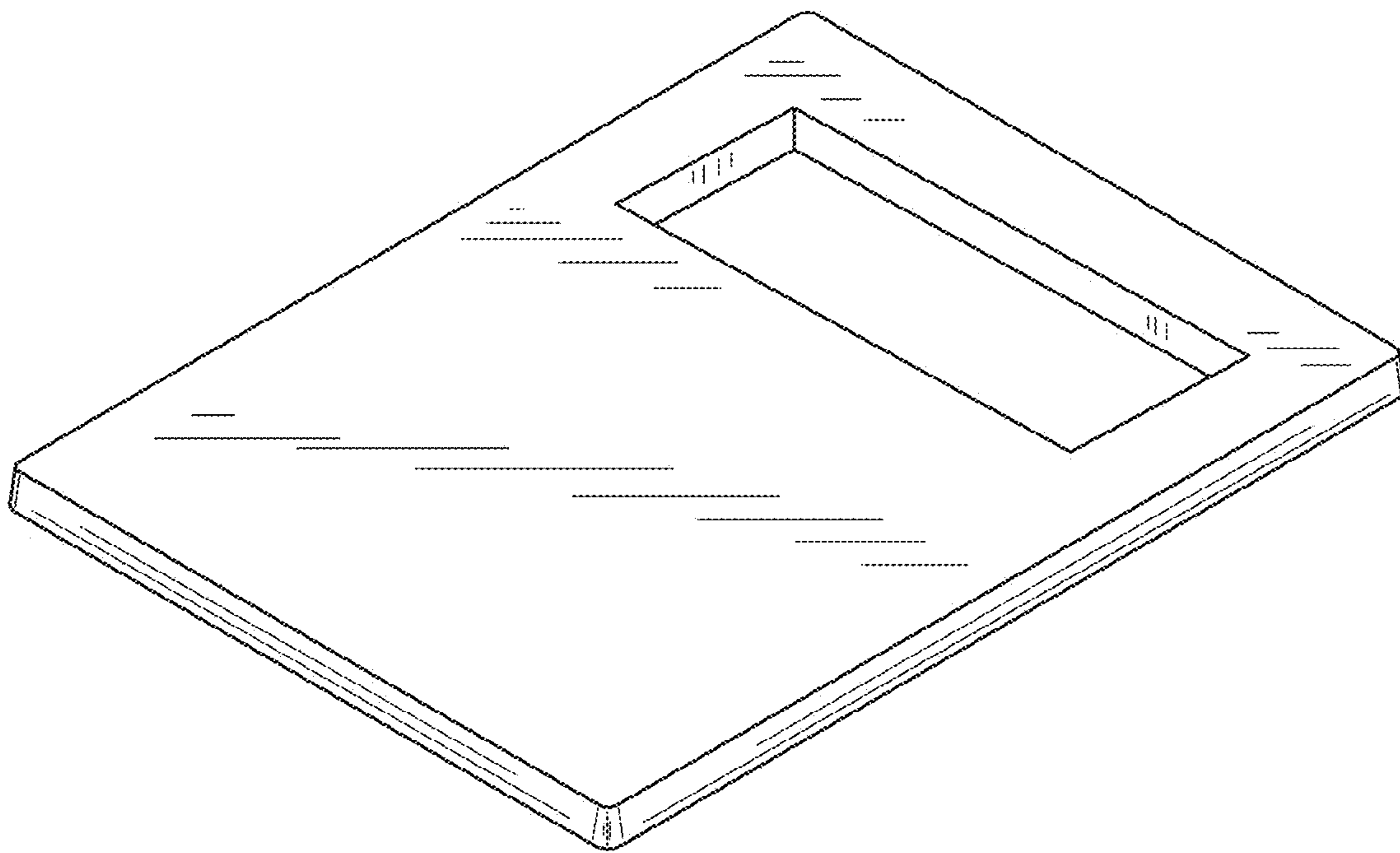

FIG.25

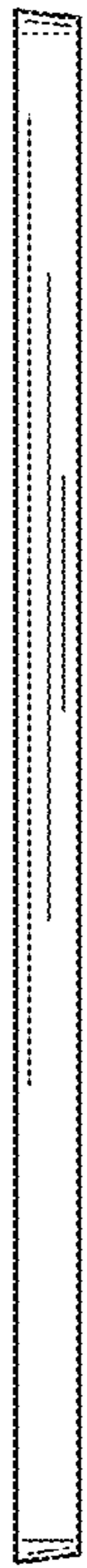

FIG. 29

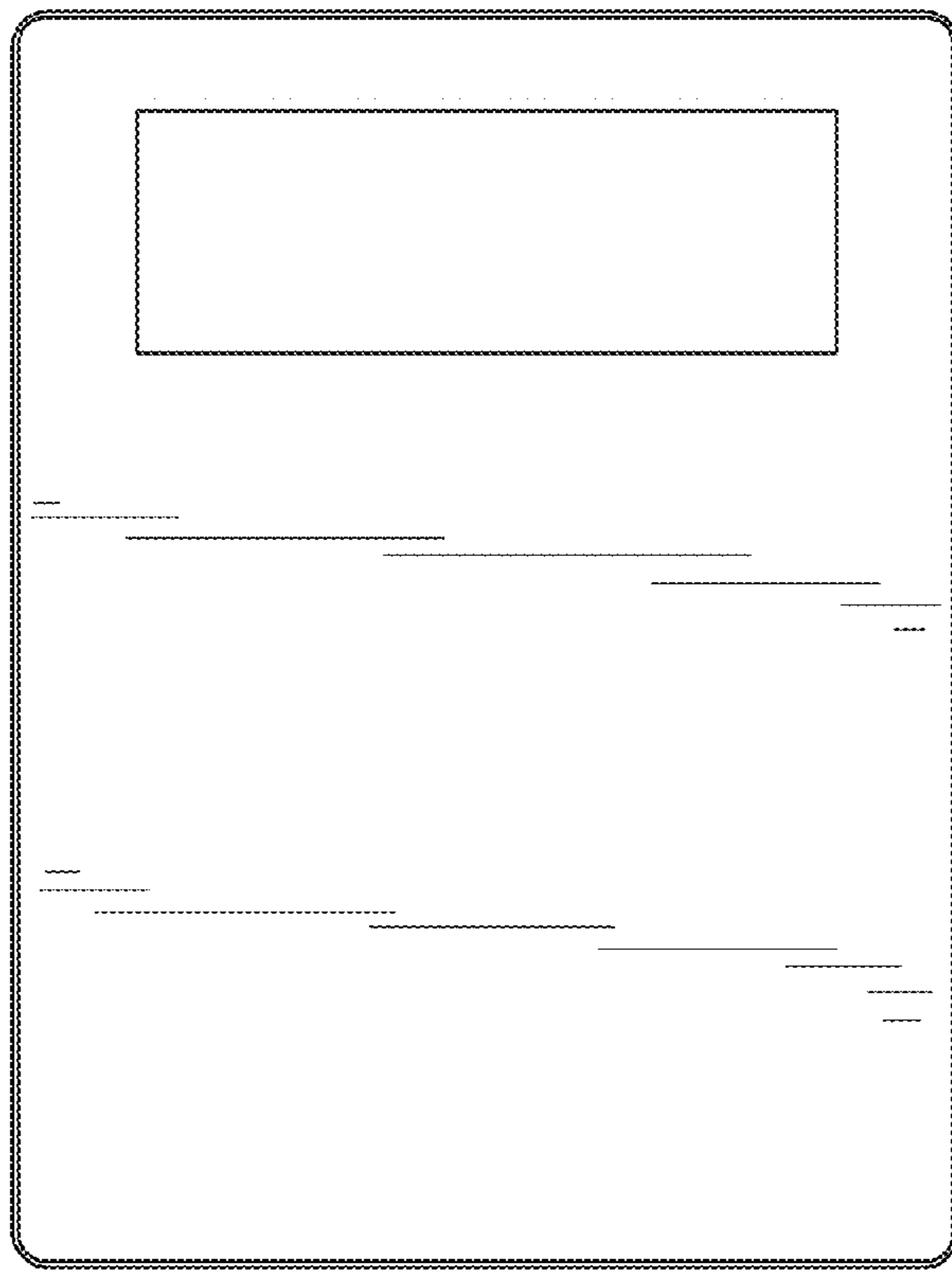

FIG. 30

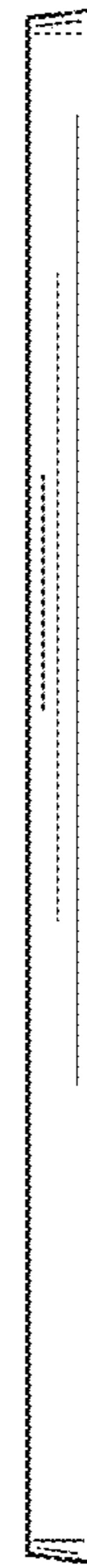

FIG. 28

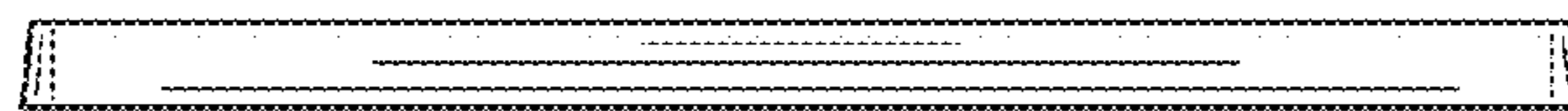

FIG. 26

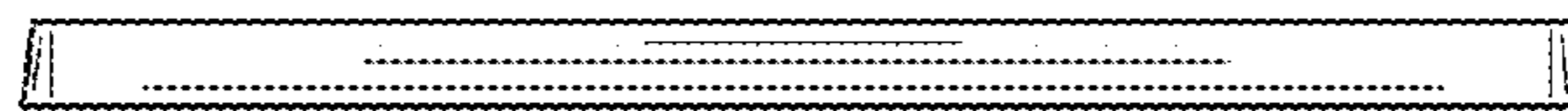

FIG. 27

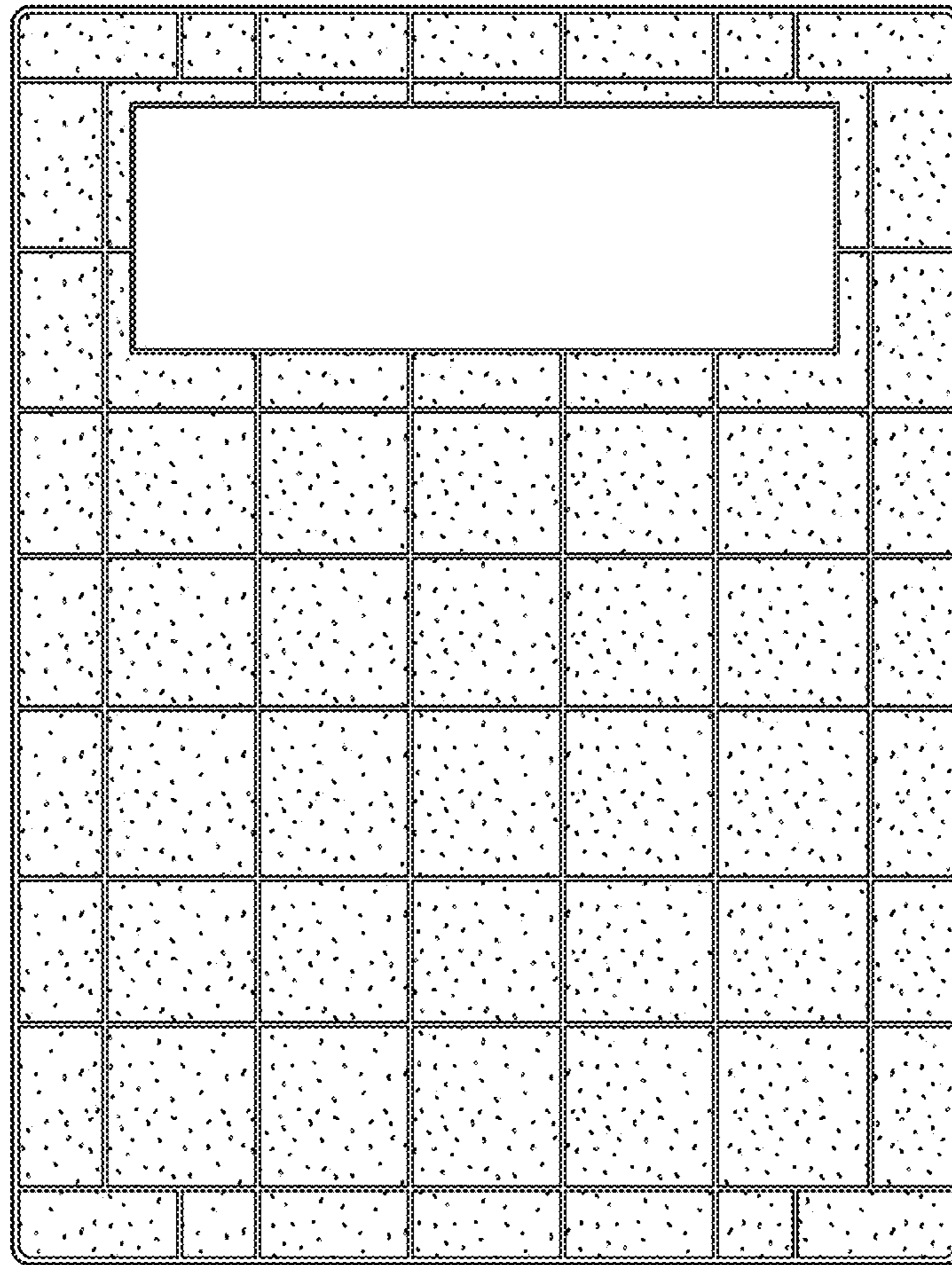

FIG.31

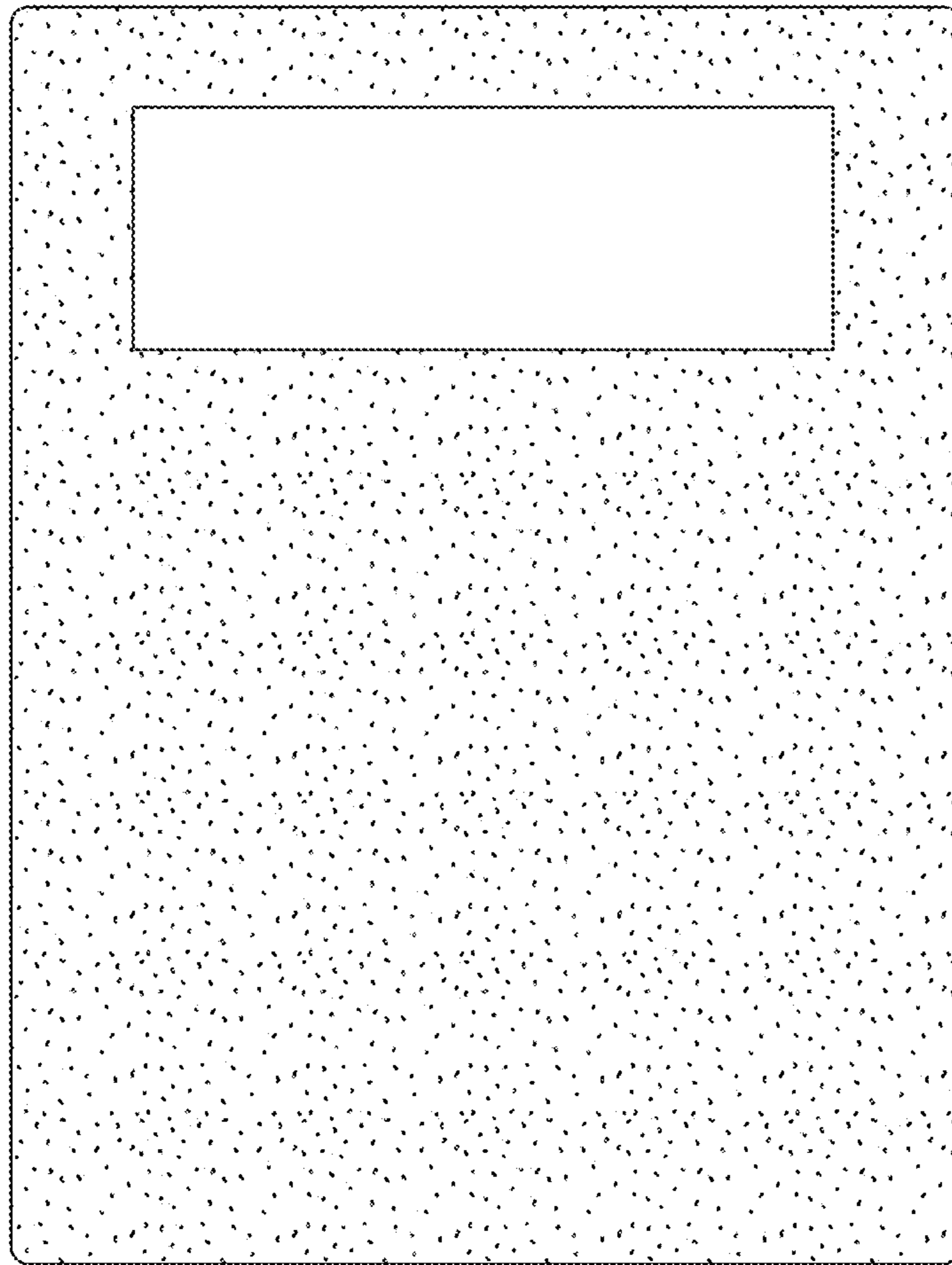

FIG.32

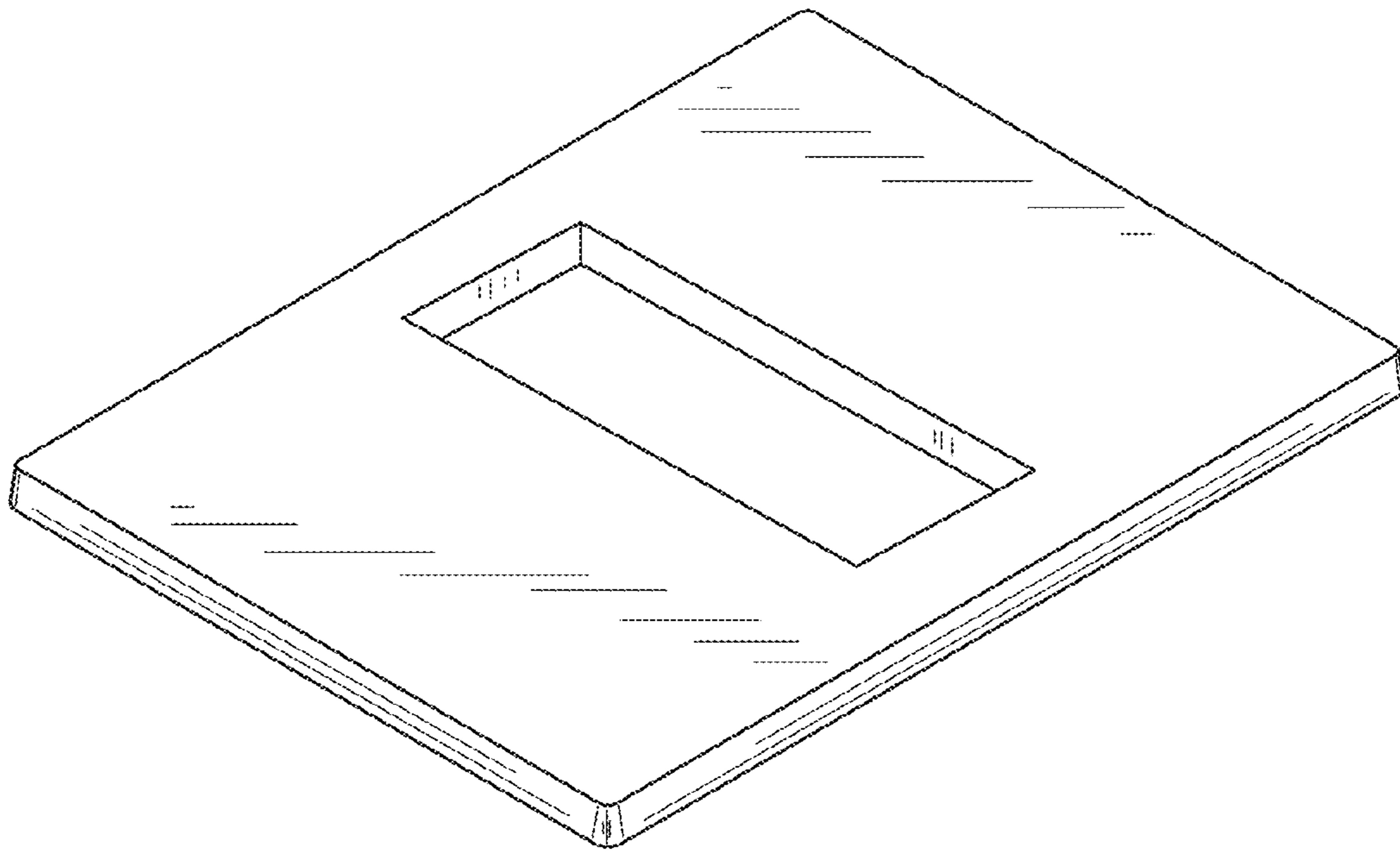

FIG.33

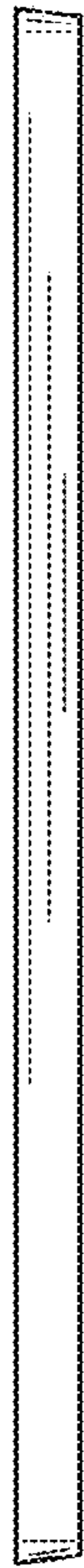

FIG. 37

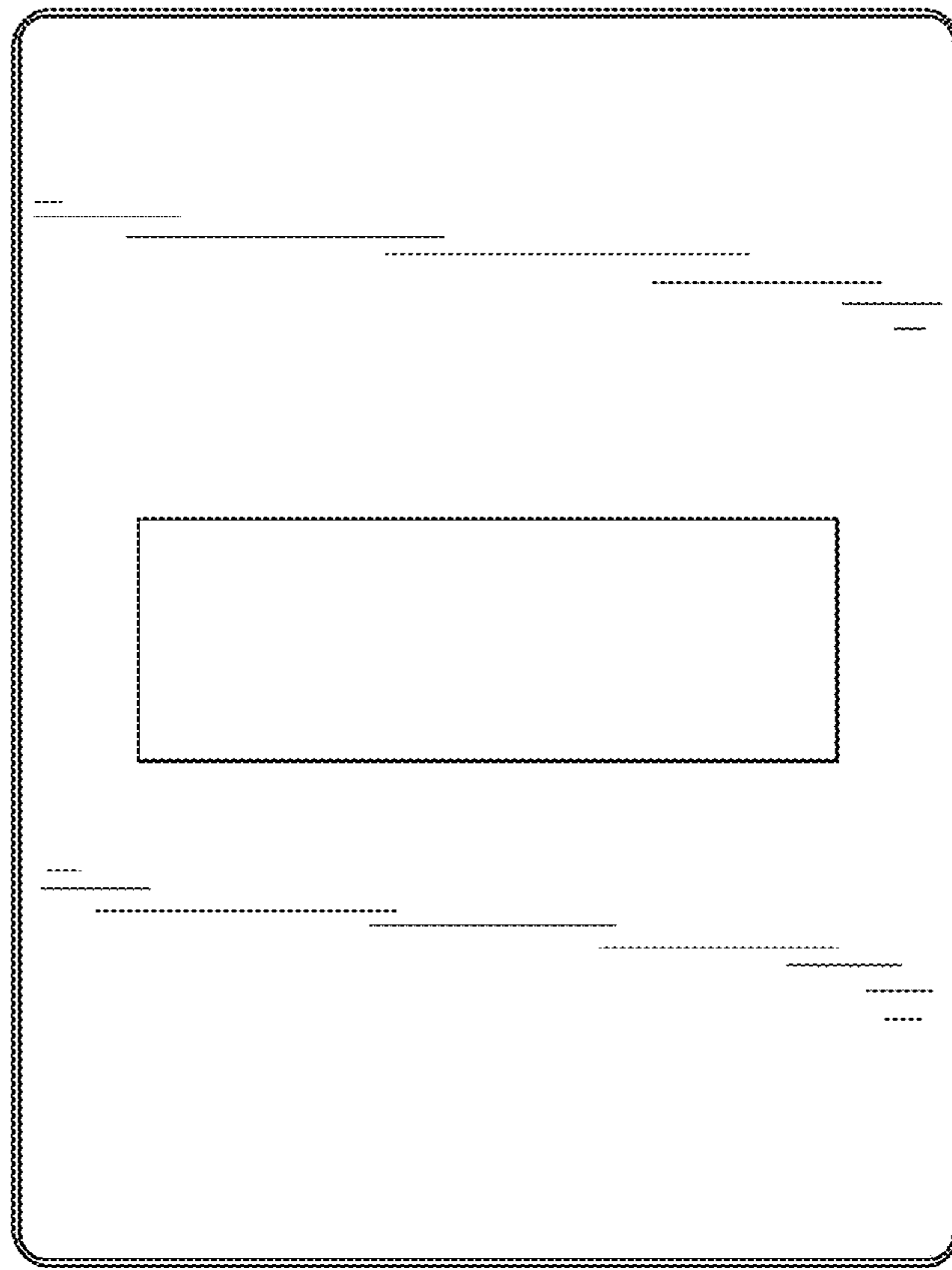

FIG. 38

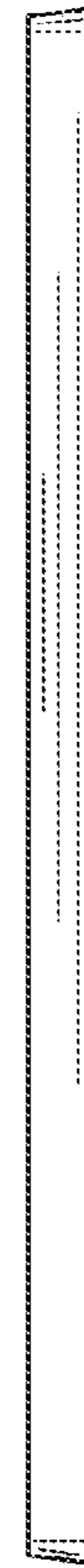

FIG. 36

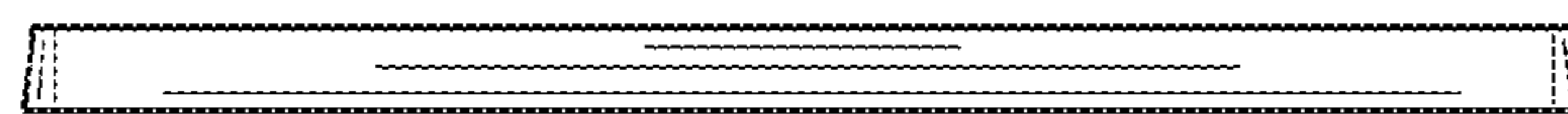

FIG. 34

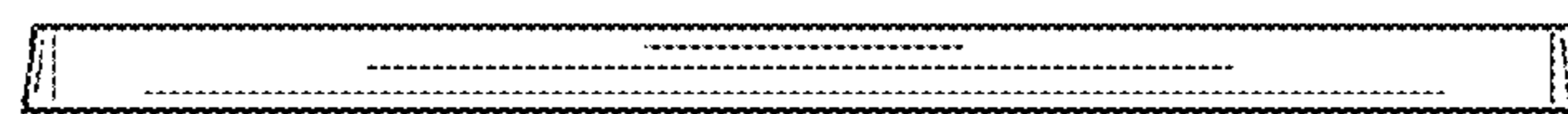

FIG. 35

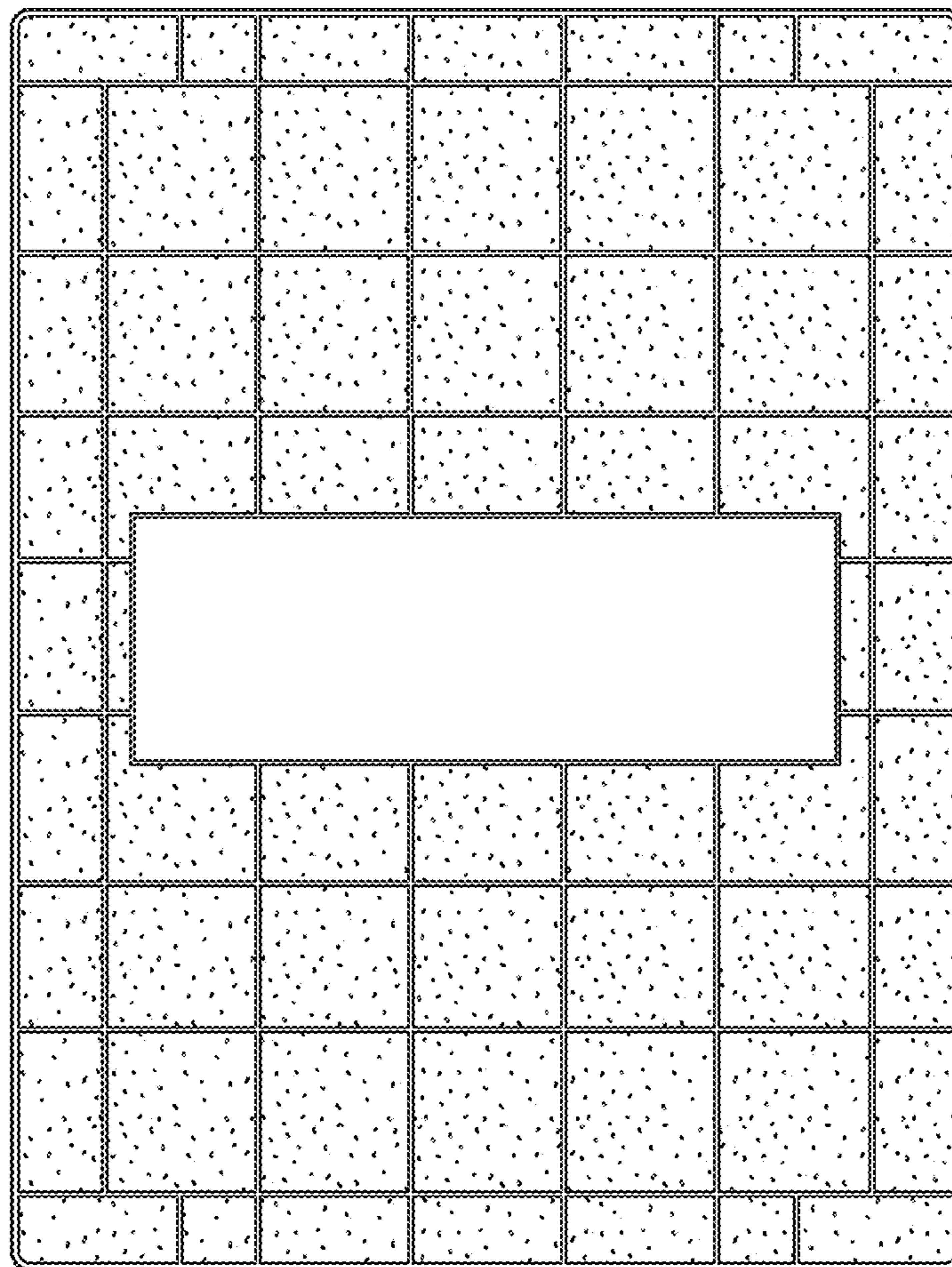

FIG.39

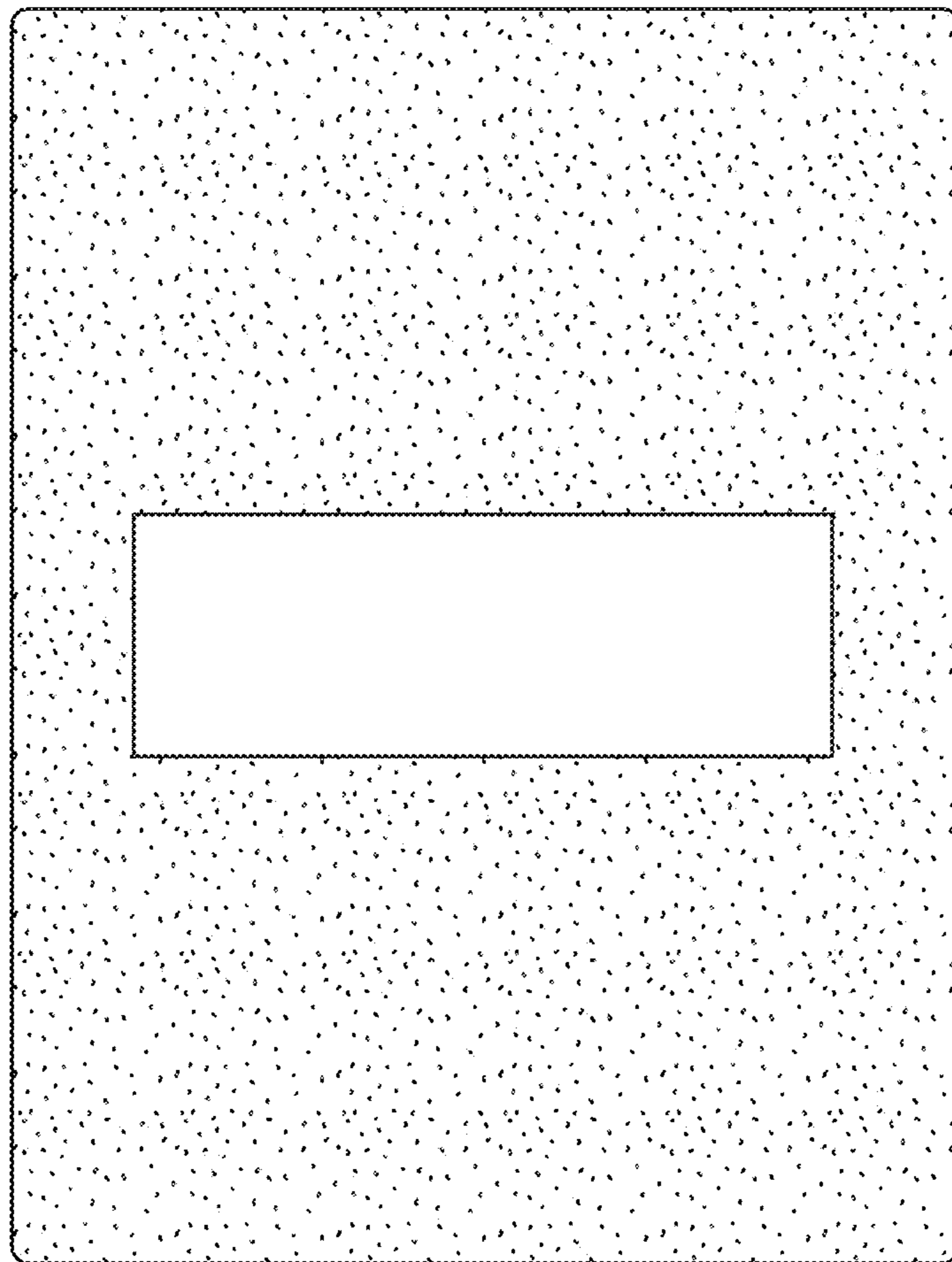

FIG.40

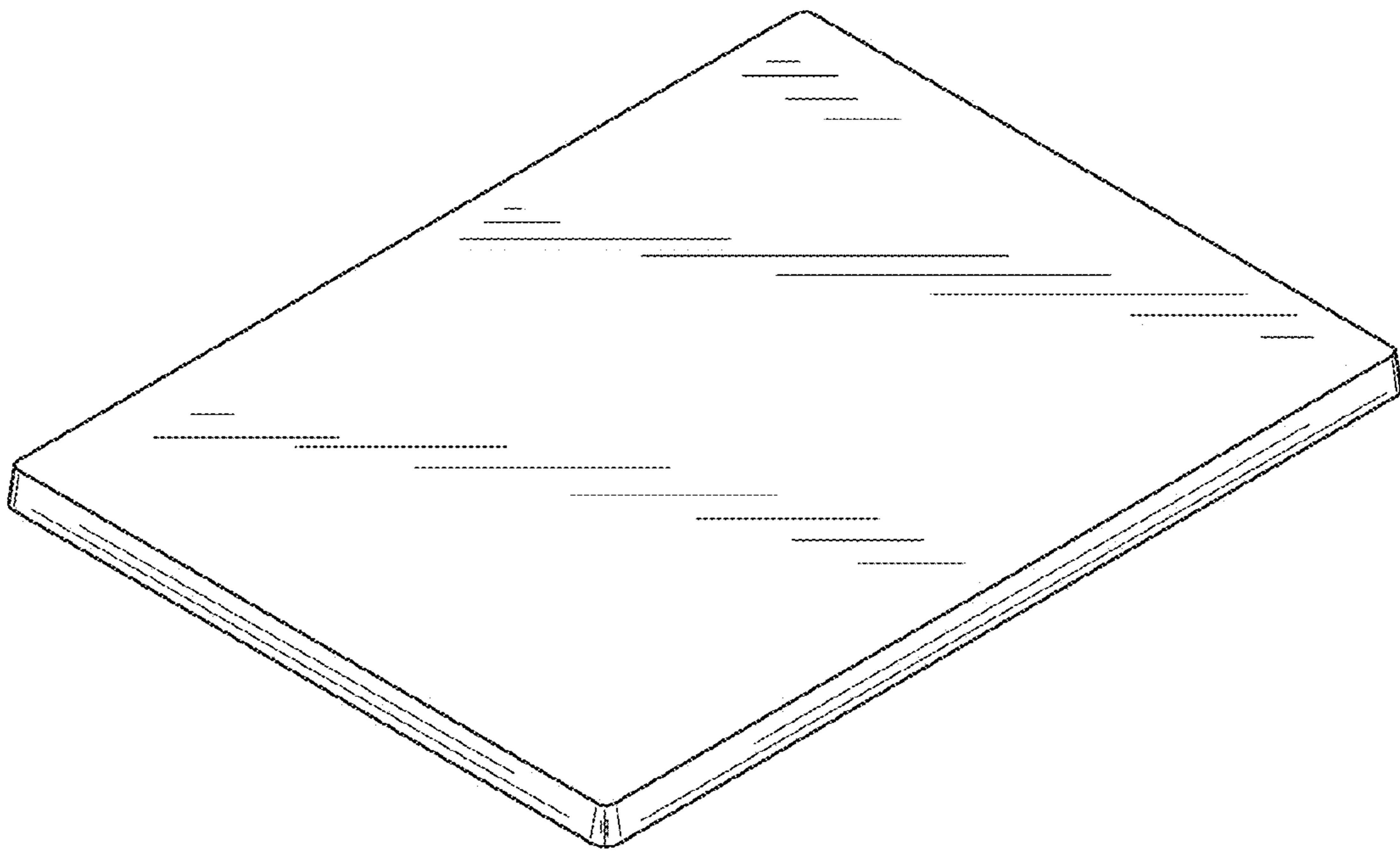

FIG.41

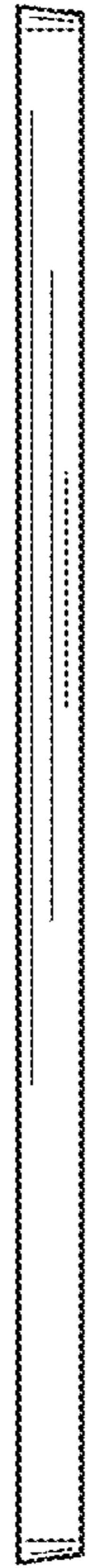

FIG. 45

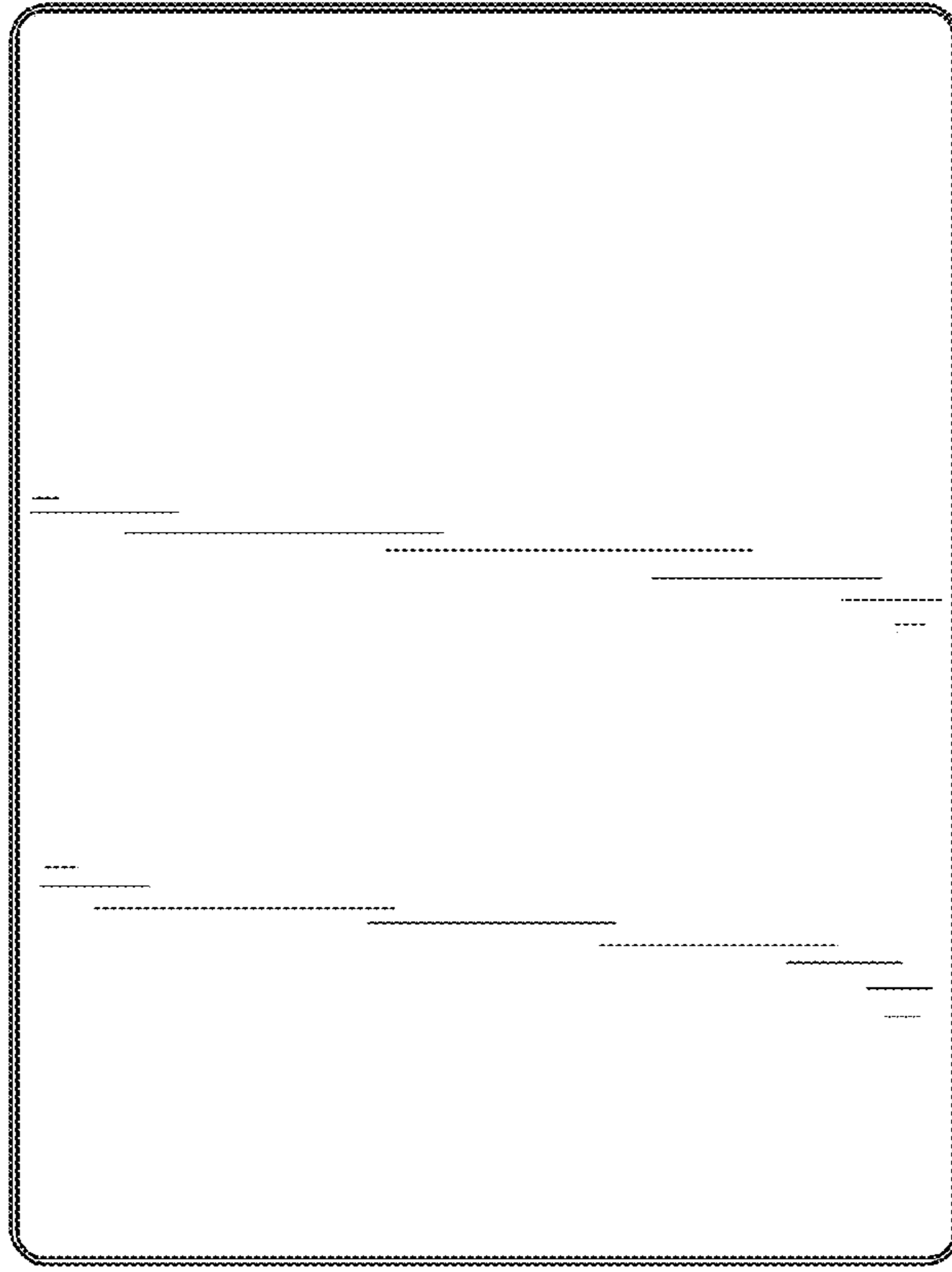

FIG. 46

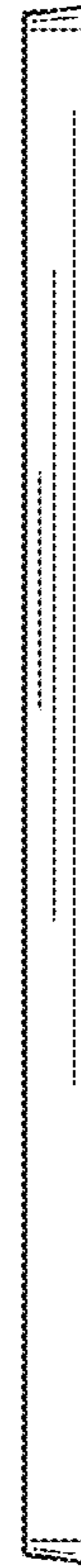

FIG. 44

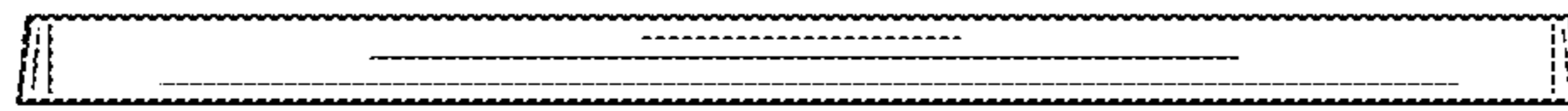

FIG. 42

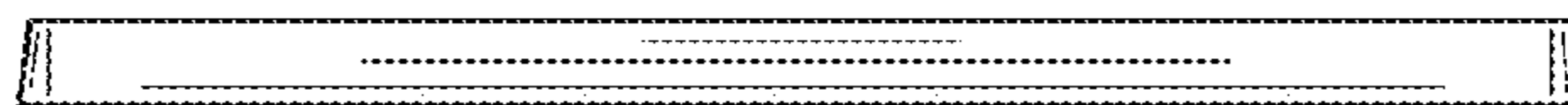

FIG. 43

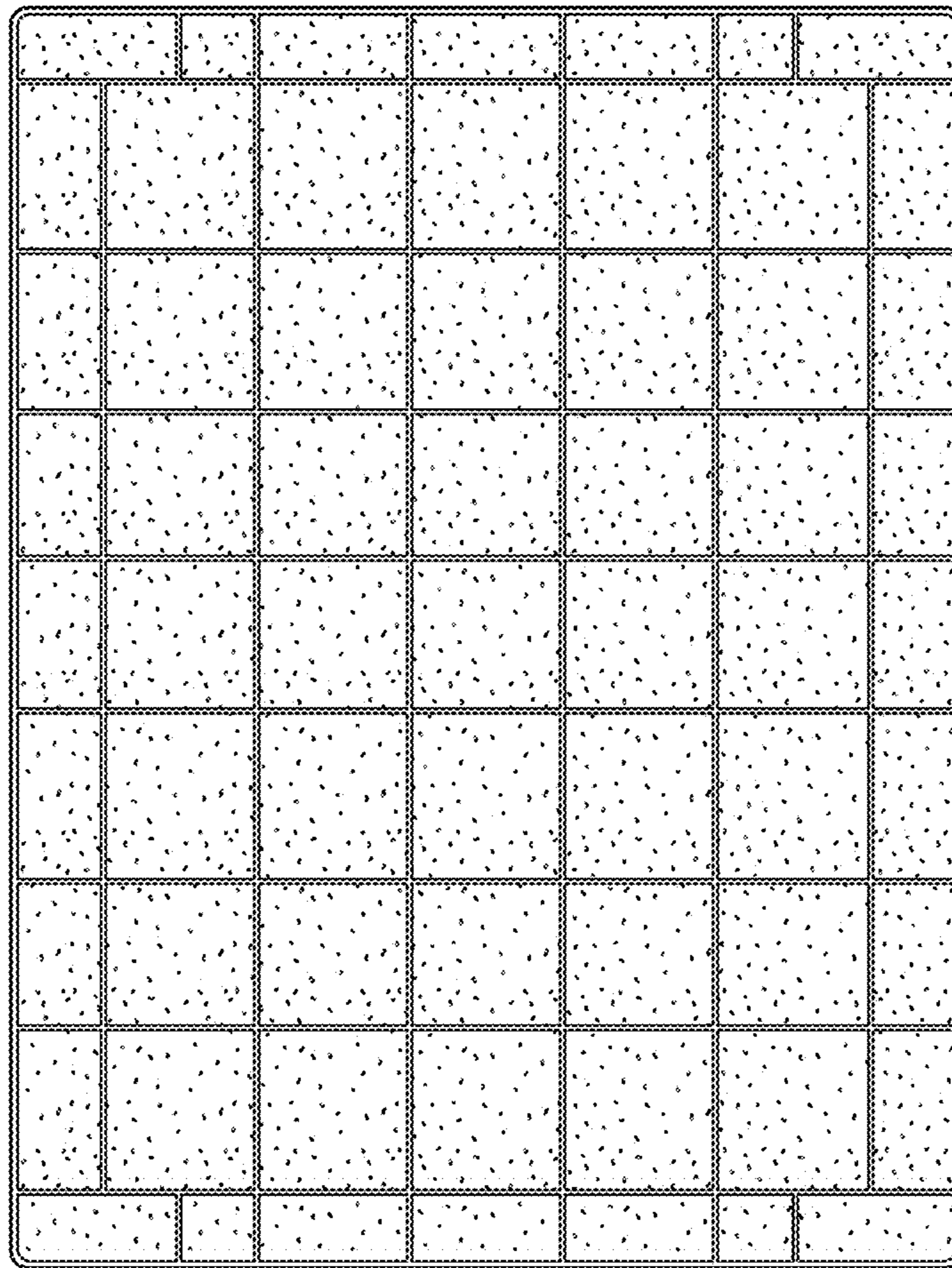

FIG.47

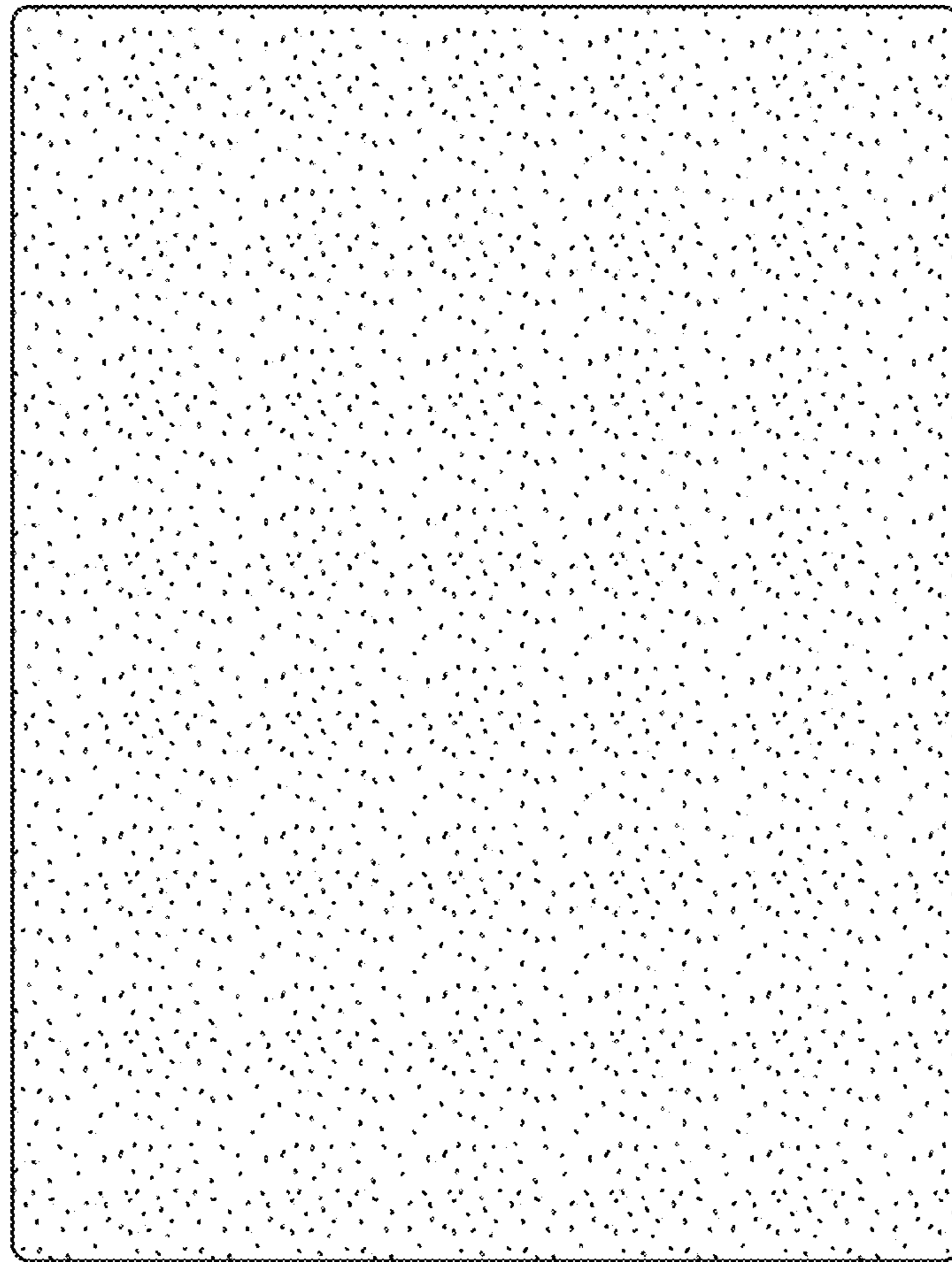

FIG.48