



US00D687214S

(12) **United States Design Patent**
Farina et al.

(10) **Patent No.:** **US D687,214 S**

(45) **Date of Patent:** **** Aug. 6, 2013**

(54) **GARMENT WAISTBAND**

(71) Applicant: **Under Armour, Inc.**, Baltimore, MD (US)

(72) Inventors: **Angela Farina**, Baltimore, MD (US);
Parisse Majd, Baltimore, MD (US)

(73) Assignee: **Under Armour, Inc.**, Baltimore, MD (US)

(**) Term: **14 Years**

(21) Appl. No.: **29/439,721**

(22) Filed: **Dec. 14, 2012**

(51) **LOC (9) Cl.** **02-02**

(52) **U.S. Cl.**
USPC **D2/853; D2/742**

(58) **Field of Classification Search**
USPC D2/712, 713, 731, 732, 737, 738,
D2/742, 853, 857, 983; 2/79, 227, 228,
235-238, 242, 247
See application file for complete search history.

(56) **References Cited**

U.S. PATENT DOCUMENTS

D235,937 S * 7/1975 Froidh et al. D24/126
D275,619 S * 9/1984 Birring D24/126

D281,540 S * 12/1985 Ternstrom D24/126
D284,036 S * 6/1986 Birring D24/126
5,954,564 A * 9/1999 Ganz 450/99
D618,434 S * 6/2010 Iamartino et al. D2/742
D618,435 S * 6/2010 Iamartino et al. D2/742
D660,553 S * 5/2012 Farina et al. D2/742
D668,434 S * 10/2012 Iamartino D2/742
D673,756 S * 1/2013 Agnew et al. D2/742
2011/0131705 A1 * 6/2011 Waldman et al. 2/221
2012/0036615 A1 * 2/2012 Bradstreet et al. 2/236

* cited by examiner

Primary Examiner — Rashida Johnson

(74) *Attorney, Agent, or Firm* — Wesley W. Muller

(57) **CLAIM**

The ornamental design for a garment waistband, as shown and described.

DESCRIPTION

FIG. 1 is a front perspective view of a garment waistband according to the present invention;
FIG. 2 is a front view of the garment waistband of FIG. 1;
FIG. 3 is a rear view of the garment waistband of FIG. 1;
FIG. 4 is a left side view of the garment waistband of FIG. 1;
FIG. 5 is a right side view of the garment waistband of FIG. 1; and,
FIG. 6 is a top view of the garment waistband of FIG. 1.
The broken lines in the figures merely illustrate the environment for the garment waistband of the present design and therefore form no part of the claimed design.

1 Claim, 6 Drawing Sheets

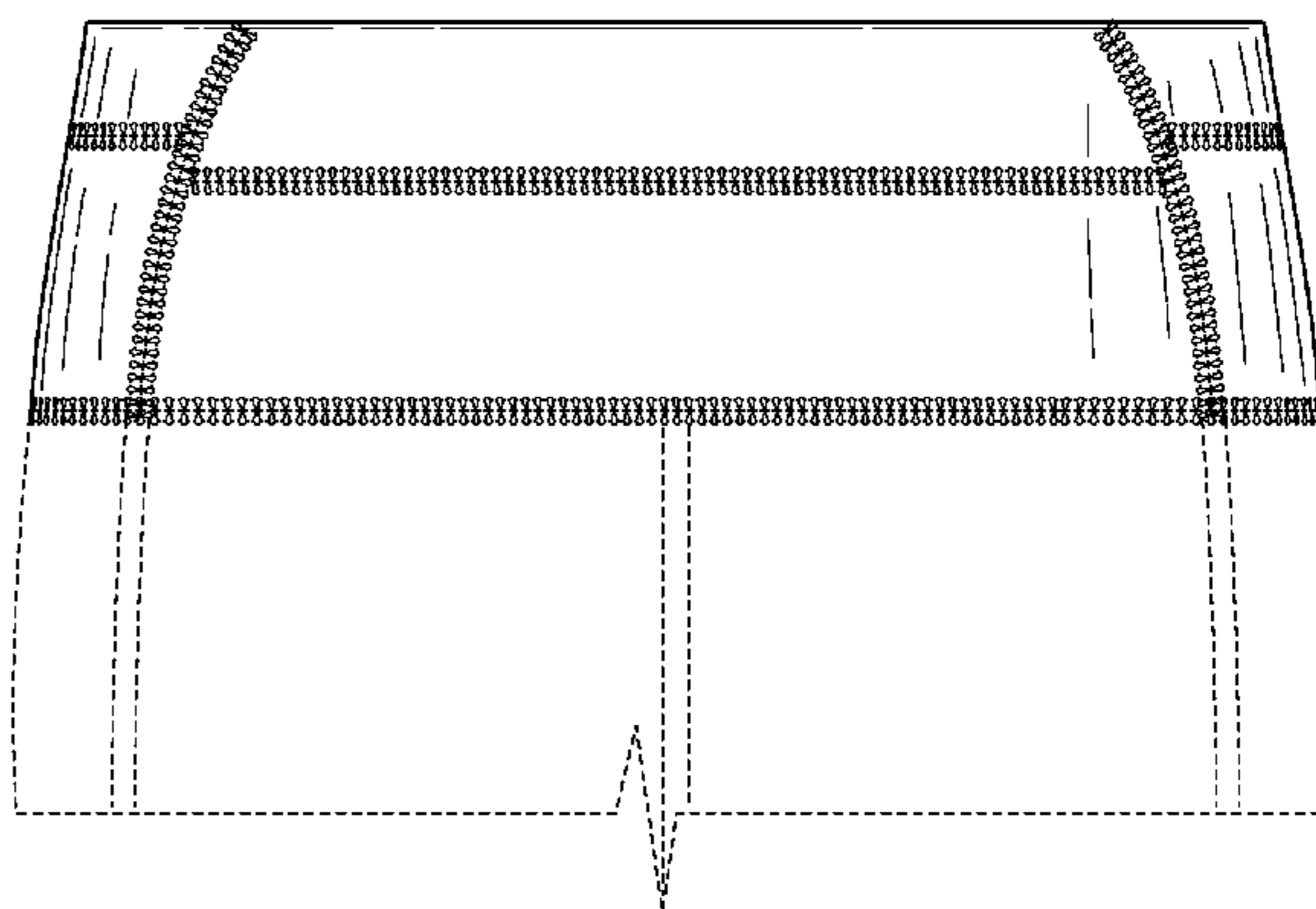
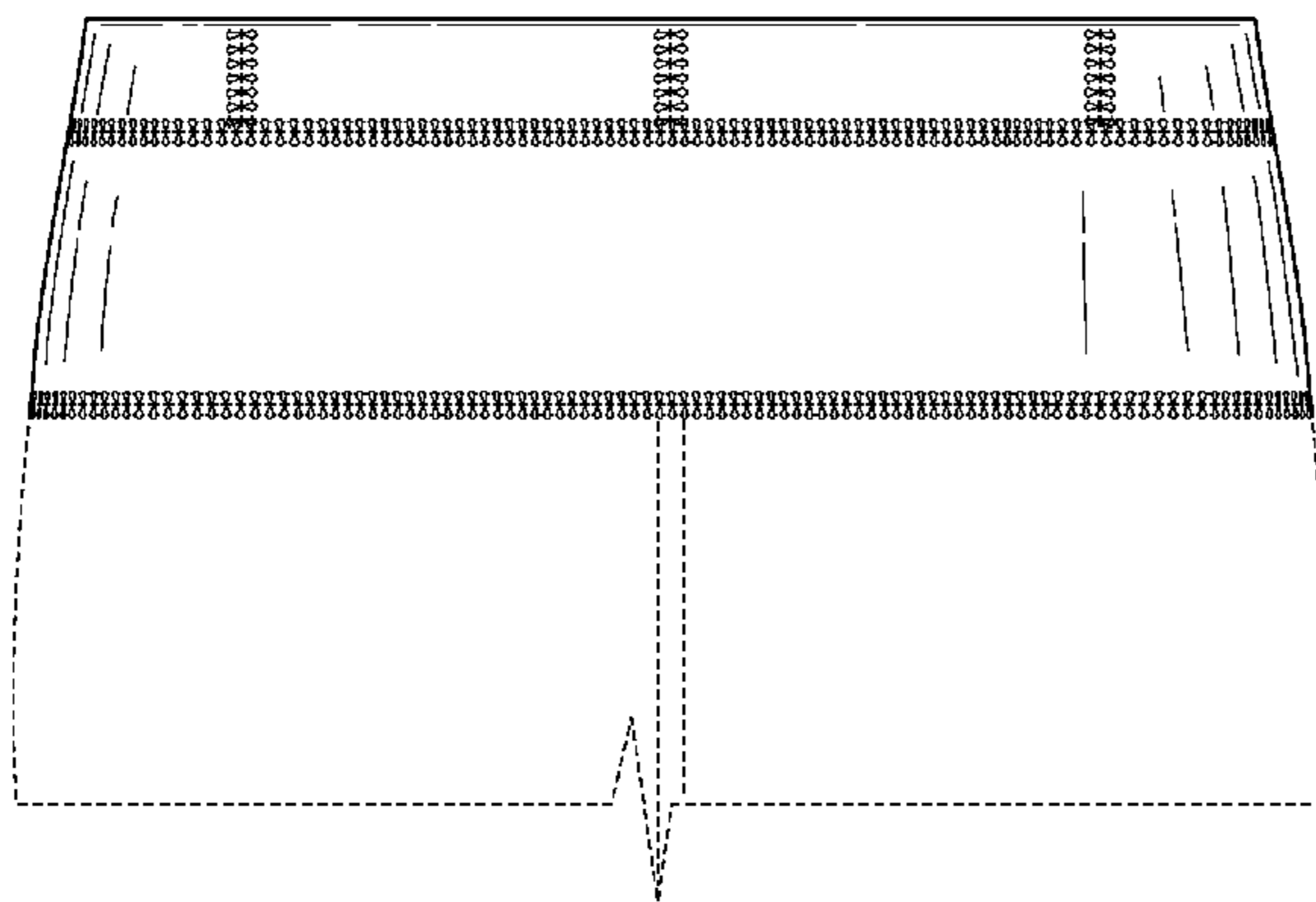

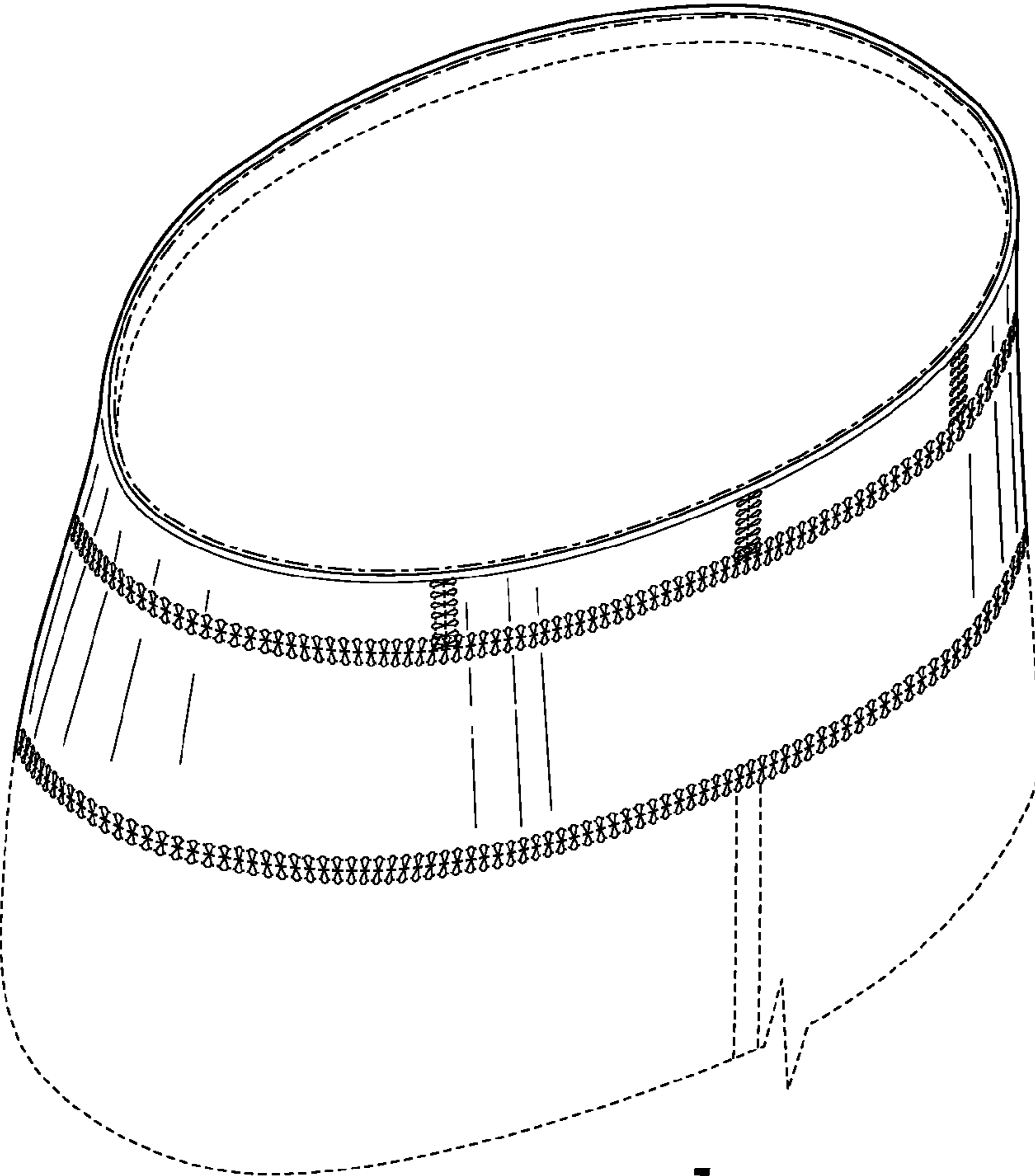

FIG. 1

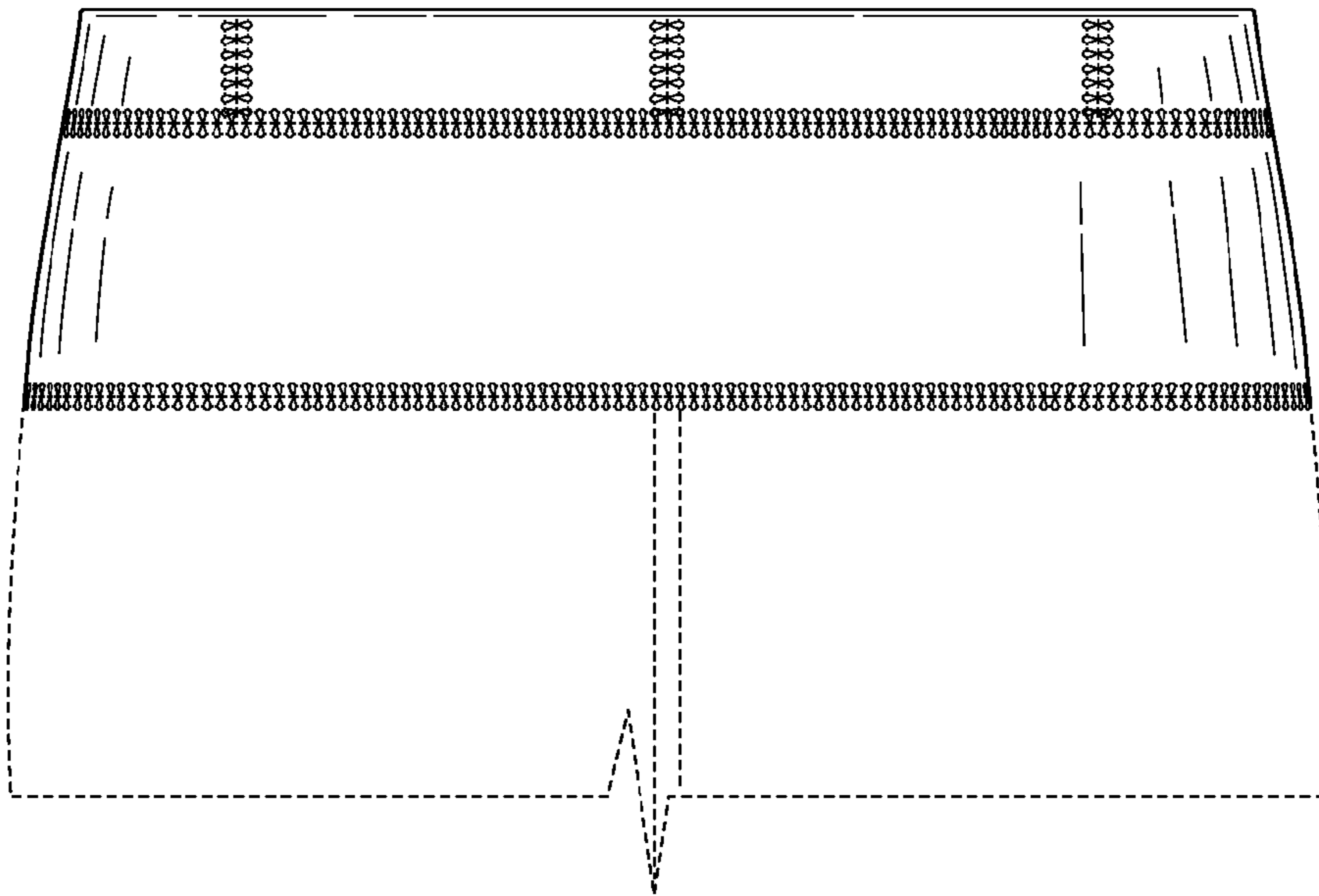

FIG. 2

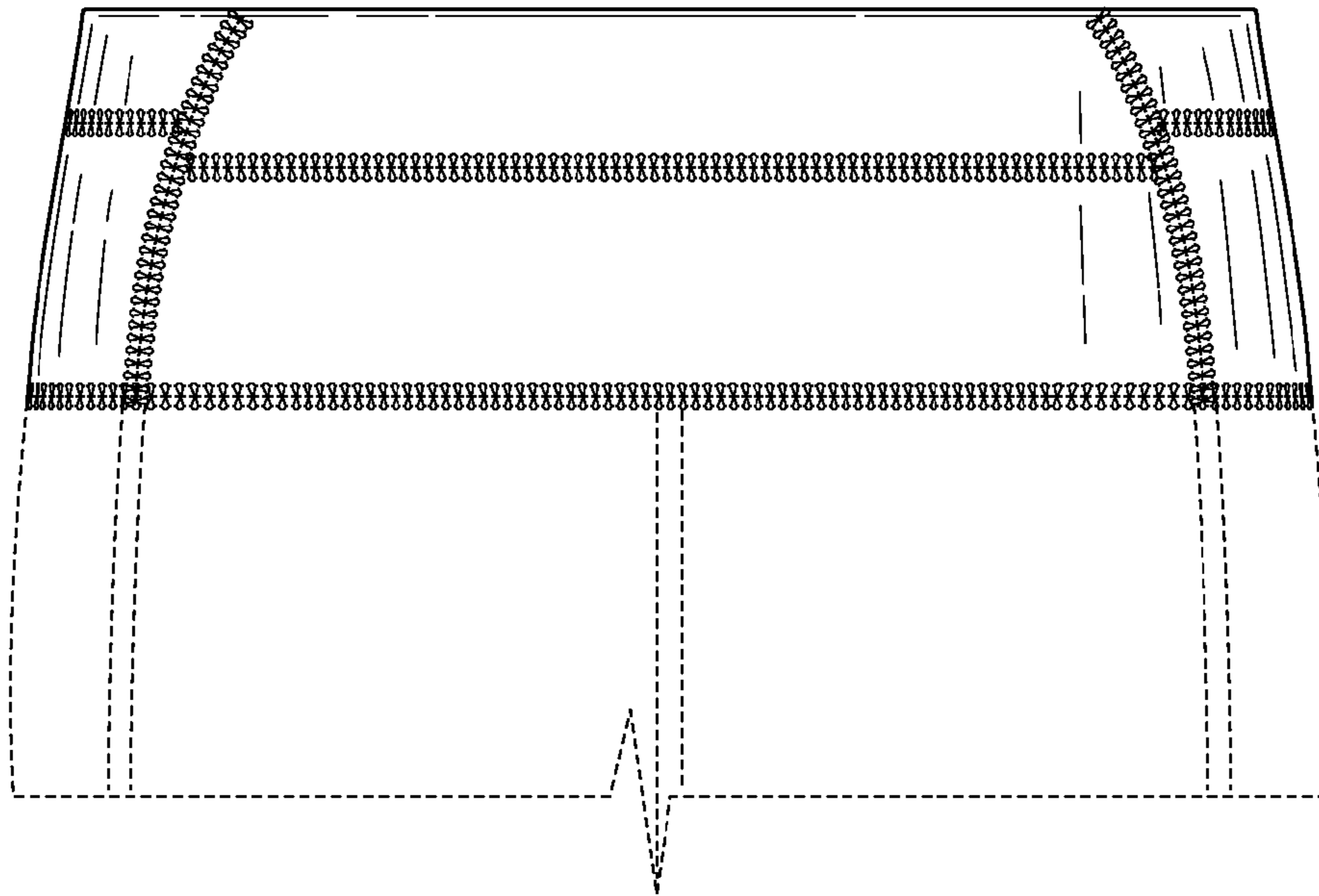

FIG. 3

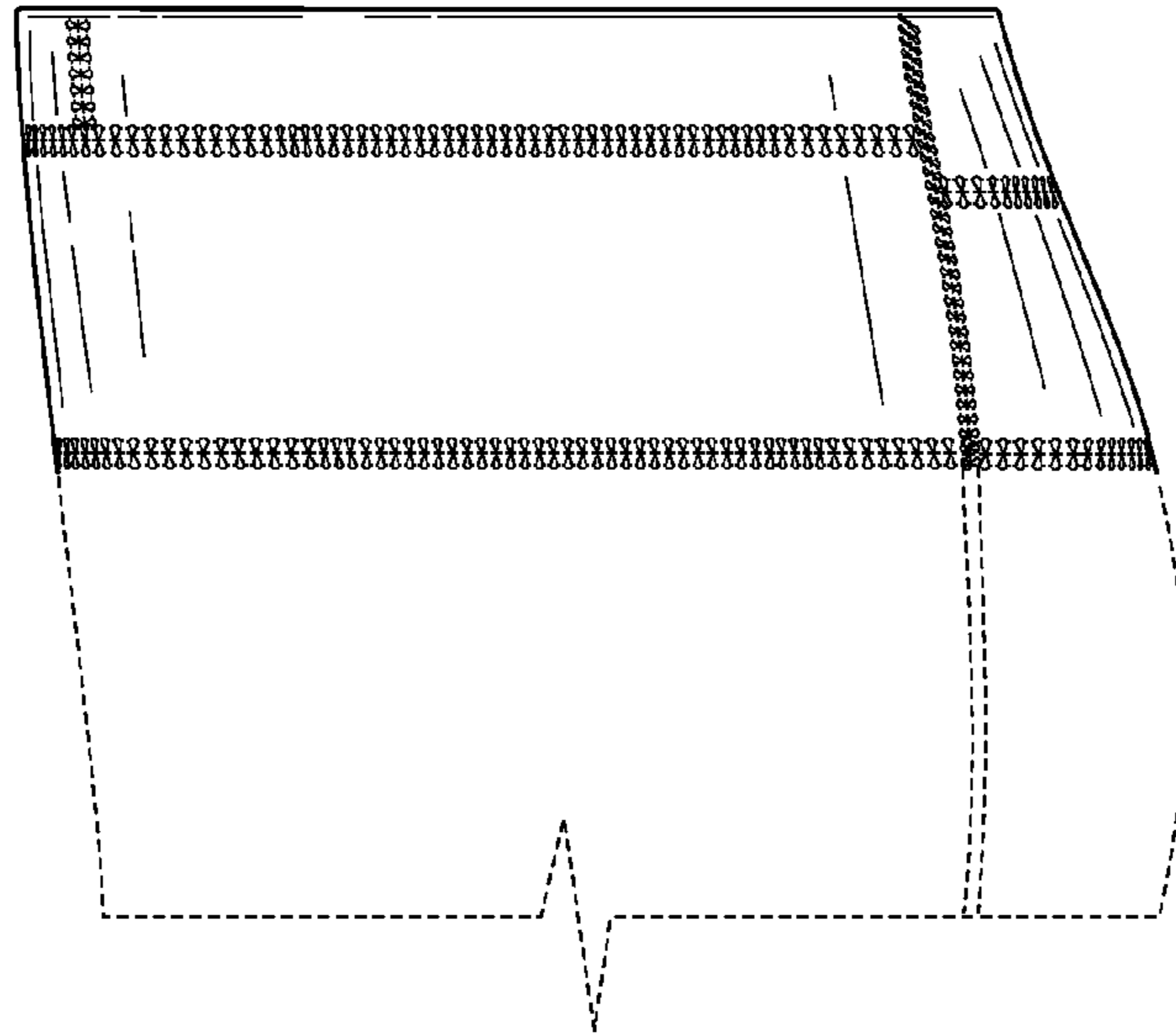

FIG. 4

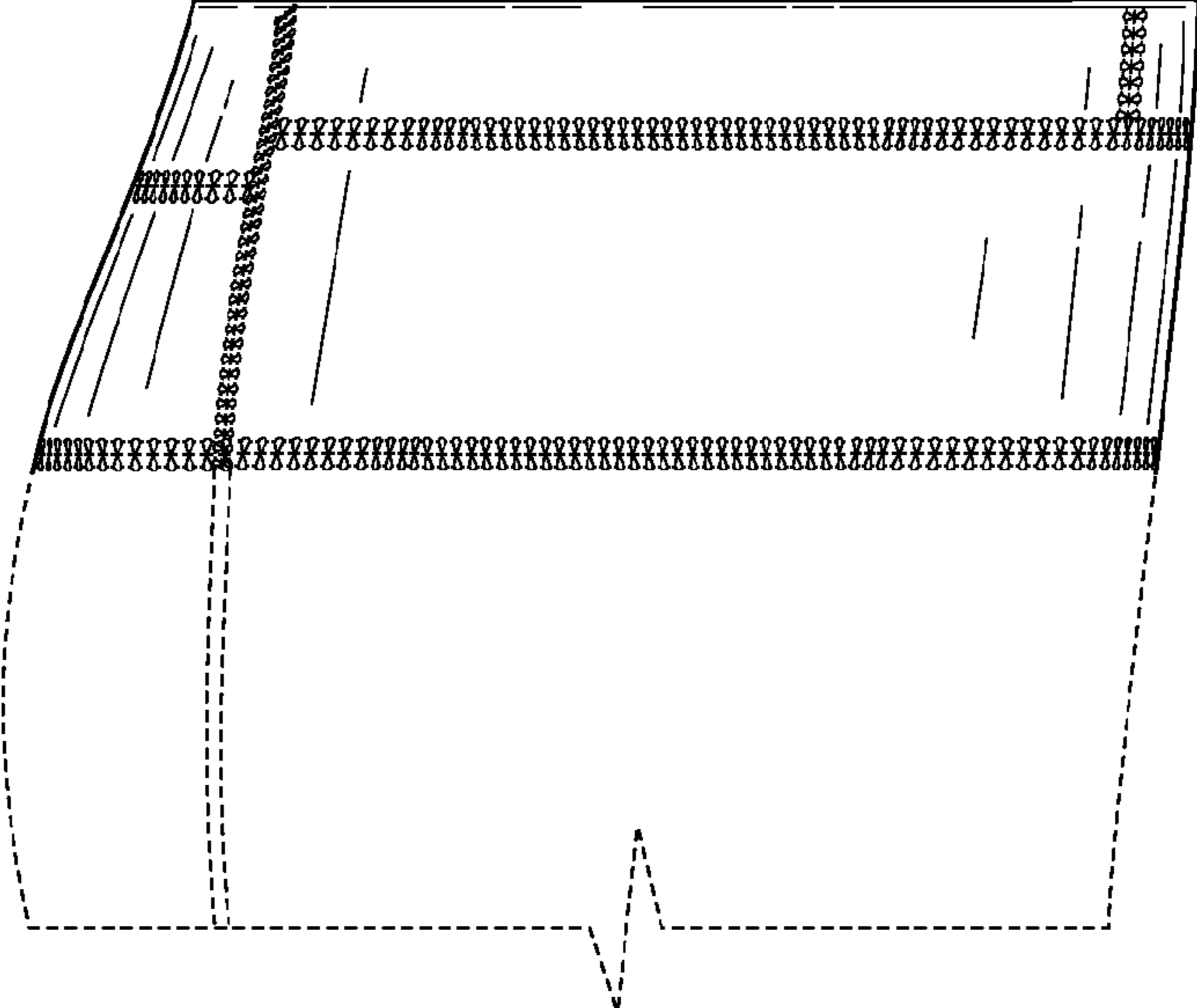

FIG. 5

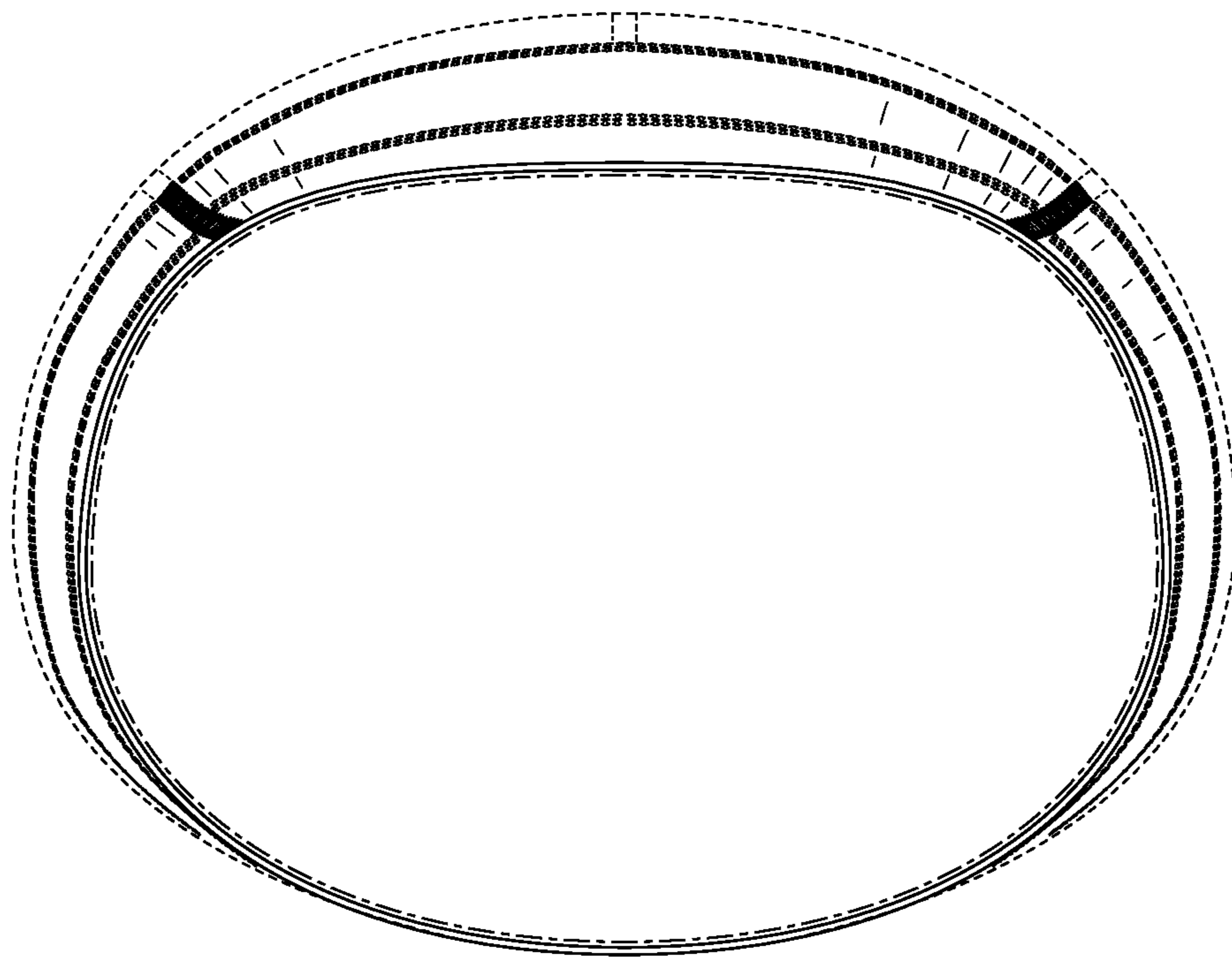

FIG. 6