



US00D687204S

(12) **United States Design Patent**
Vasilakes et al.

(10) **Patent No.:** **US D687,204 S**
(45) **Date of Patent:** **** Jul. 30, 2013**

(54) **DUSTPAN**
(75) Inventors: **Lloyd S. Vasilakes**, Stillwater, MN (US);
Qian Zheng Zhou, Shanghai (CN);
Giuseppe De Bellis, Milanese (IT);
Lizabeth W. Dretzka, Woodbury, MN
(US); **Valentina Tronconi**, Milan (IT);
Monica Jerez, Woodbury, MN (US);
Adel M. Kassem Llano, Milan (IT)

(73) Assignee: **3M Innovative Properties Company**,
St. Paul, MN (US)

(**) Term: **14 Years**

(21) Appl. No.: **29/425,722**

(22) Filed: **Jun. 26, 2012**
(Under 37 CFR 1.47)

(51) **LOC (9) Cl.** **07-05**

(52) **U.S. Cl.**
USPC **D32/74**

(58) **Field of Classification Search**
USPC D32/74, 41; D30/162; D7/691, 688; D4/116;
15/257.5, 257.3, 257.2, 257.1; 134/6
See application file for complete search history.

(56) **References Cited**

U.S. PATENT DOCUMENTS

D367,745 S * 3/1996 Feldman et al. D32/74
D427,739 S * 7/2000 Demore D32/74
D463,643 S * 9/2002 Petner D32/74
D470,289 S * 2/2003 Petner D32/74

D475,828 S * 6/2003 Libman et al. D32/74
D492,489 S * 7/2004 Hay et al. D4/116
D508,760 S * 8/2005 Berti D32/74
D510,165 S * 9/2005 Berti D32/74
D580,700 S * 11/2008 Corcoran D7/354
D586,970 S * 2/2009 Berti D32/74
D599,072 S * 8/2009 Meyer D32/74
D630,401 S * 1/2011 Libman et al. D32/74
D667,191 S * 9/2012 Libman et al. D32/74
D667,192 S * 9/2012 Libman et al. D32/74
2007/0089259 A1 * 4/2007 Jones 15/257.2

* cited by examiner

Primary Examiner — Austin Murphy

(74) *Attorney, Agent, or Firm* — Irina Hass

(57) **CLAIM**

The ornamental design for a dustpan, as shown and described.

DESCRIPTION

FIG. 1 is a perspective view of the new design for a dustpan;
FIG. 2 is a front view thereof;
FIG. 3 is a rear view thereof;
FIG. 4 is a bottom view thereof;
FIG. 5 is a top view thereof;
FIG. 6 is a right side view thereof;
FIG. 7 is a left side view thereof; and,
FIG. 8 is a perspective view thereof showing the dustpan with
a broom.

The broken lines in the drawings are shown for illustrative
purposes only and form no part of the claimed design. In
addition, the surface shading illustrated in the drawings is
provided merely to highlight the contour of design; it is not
intended to be illustrative of texture or gloss.

1 Claim, 4 Drawing Sheets

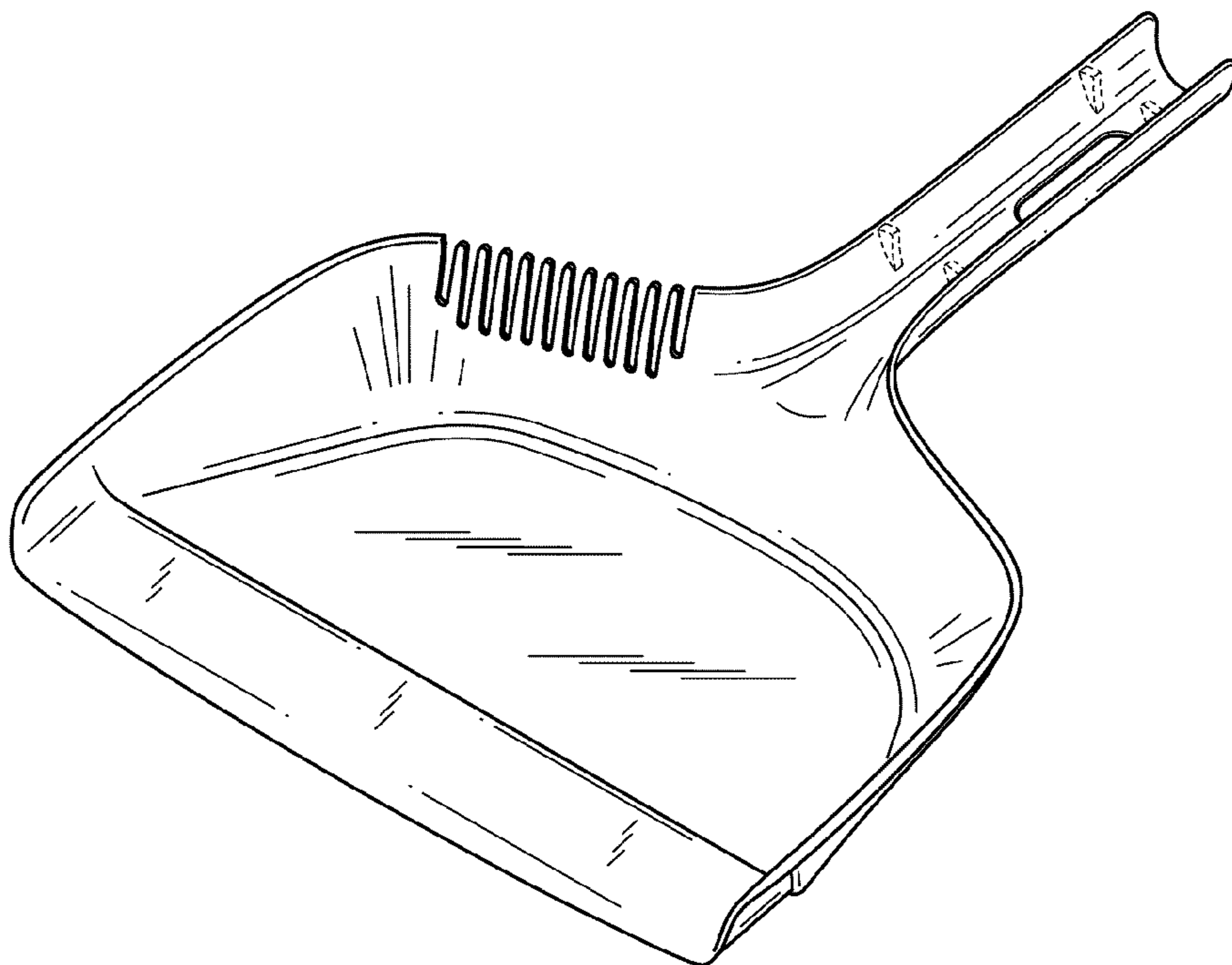

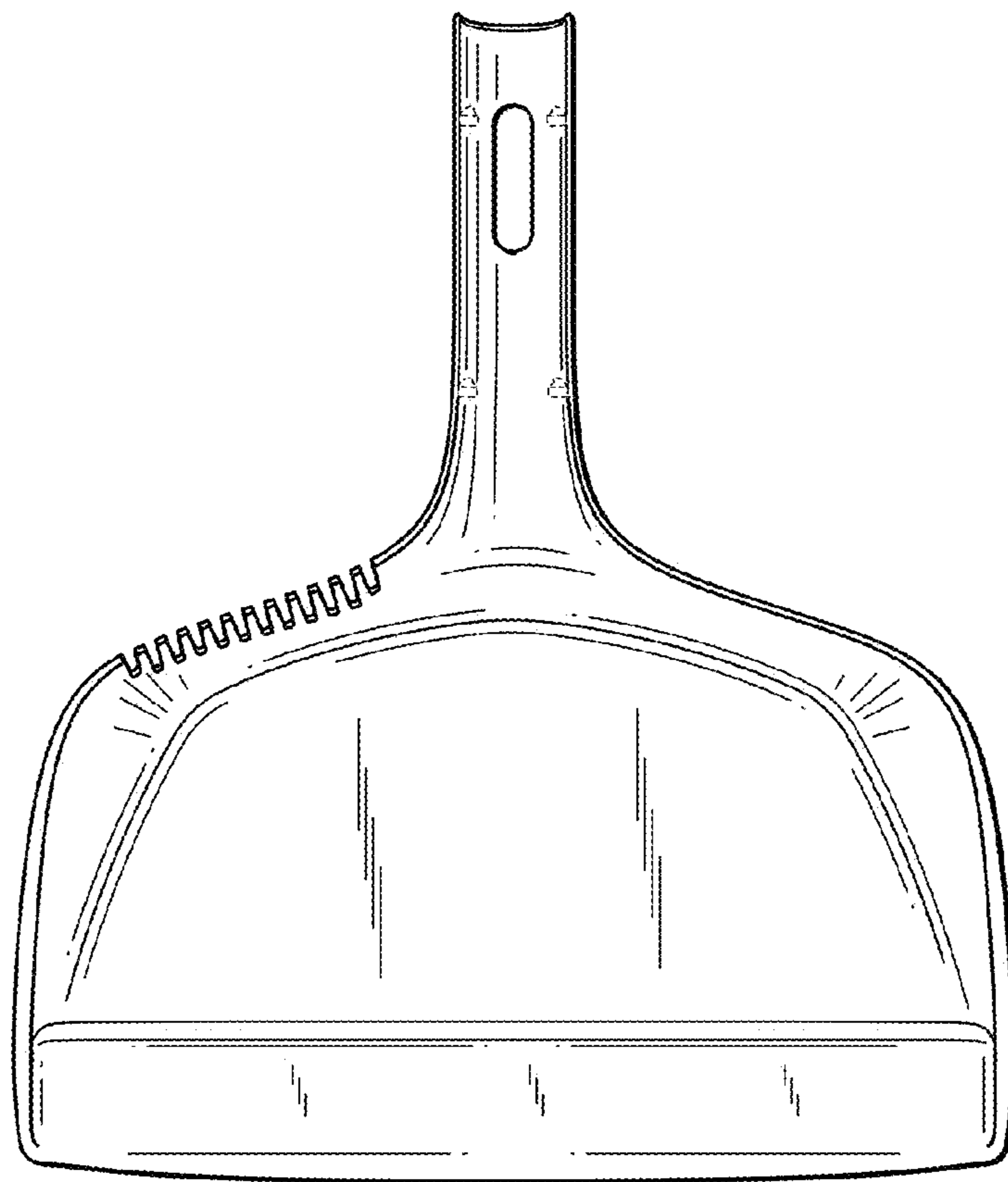
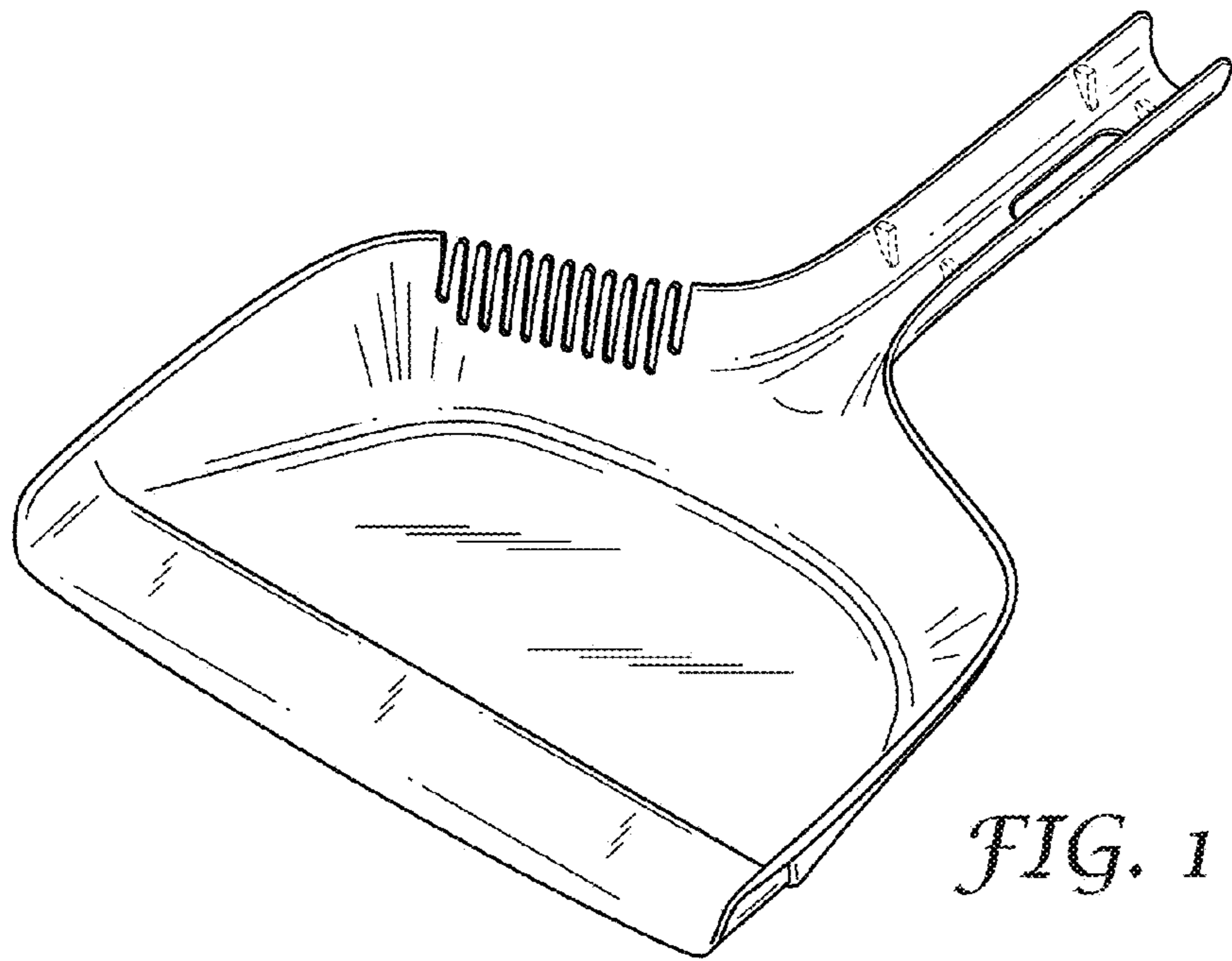

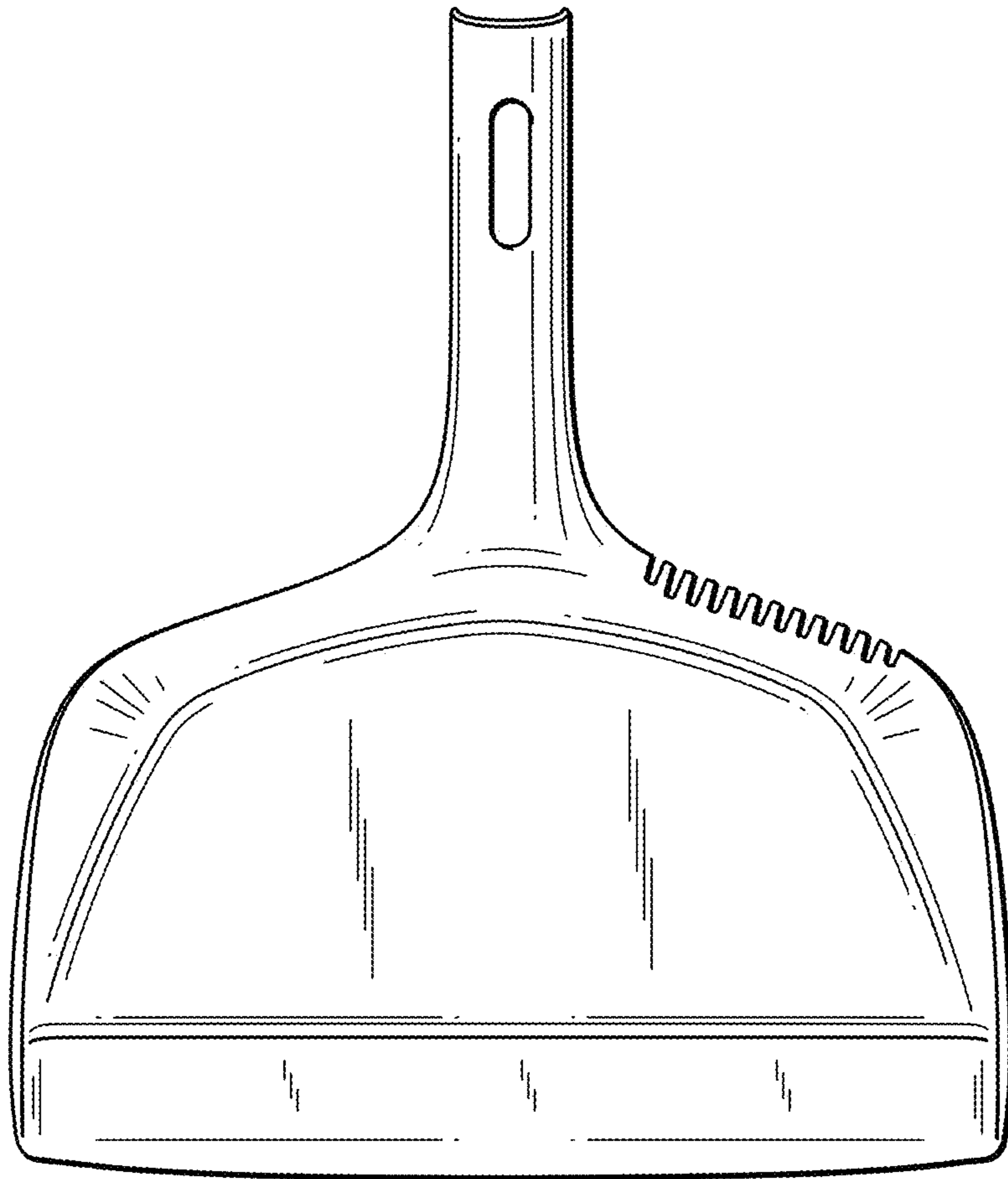

FIG. 3

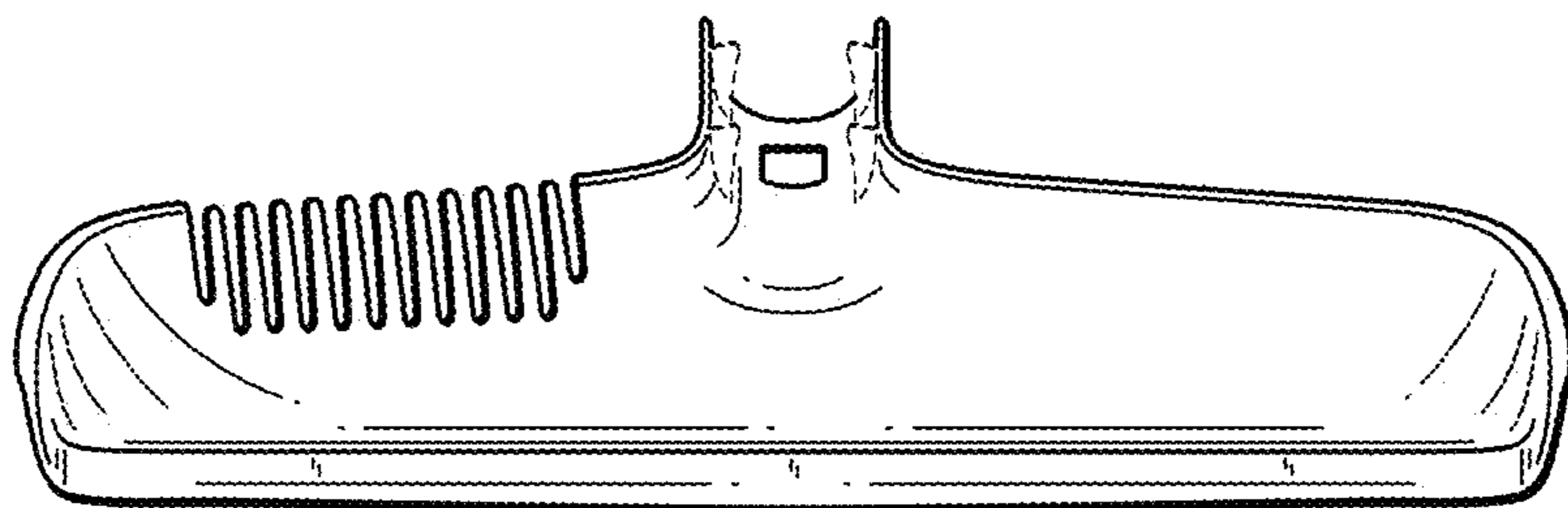

FIG. 4

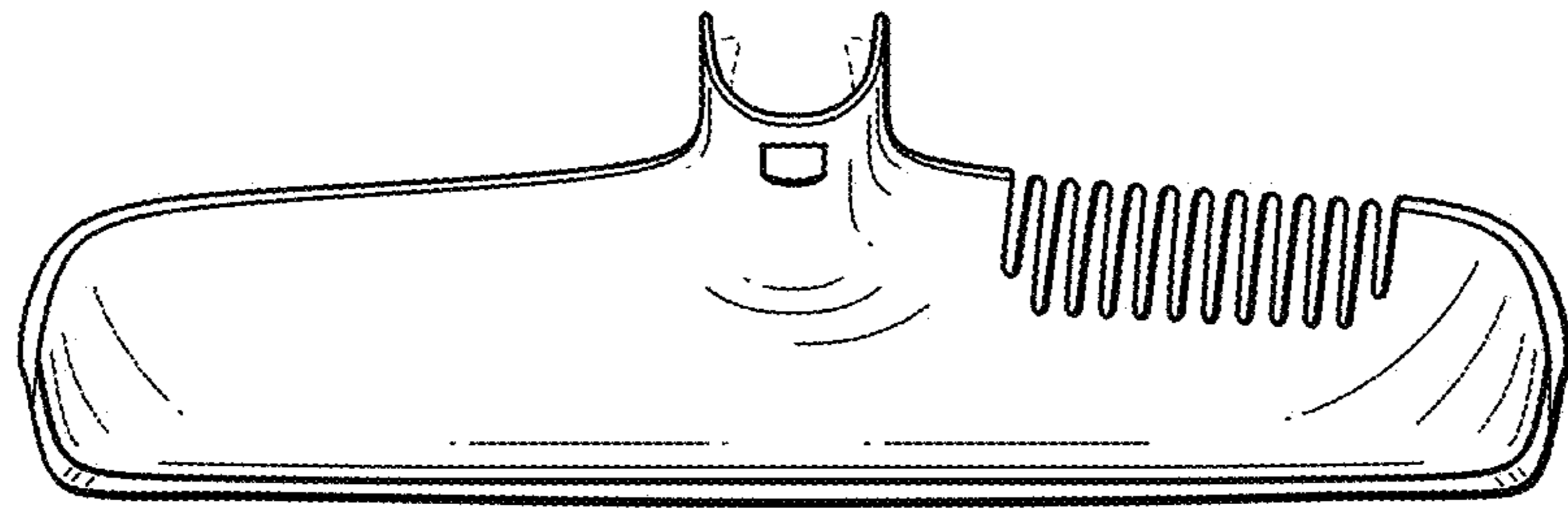

FIG. 5

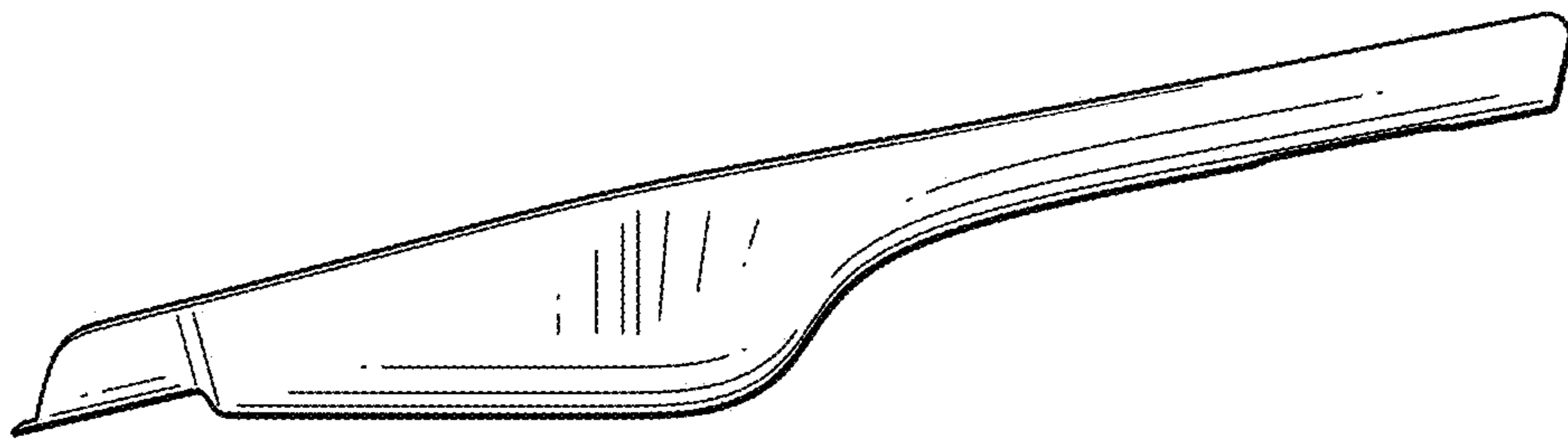

FIG. 6

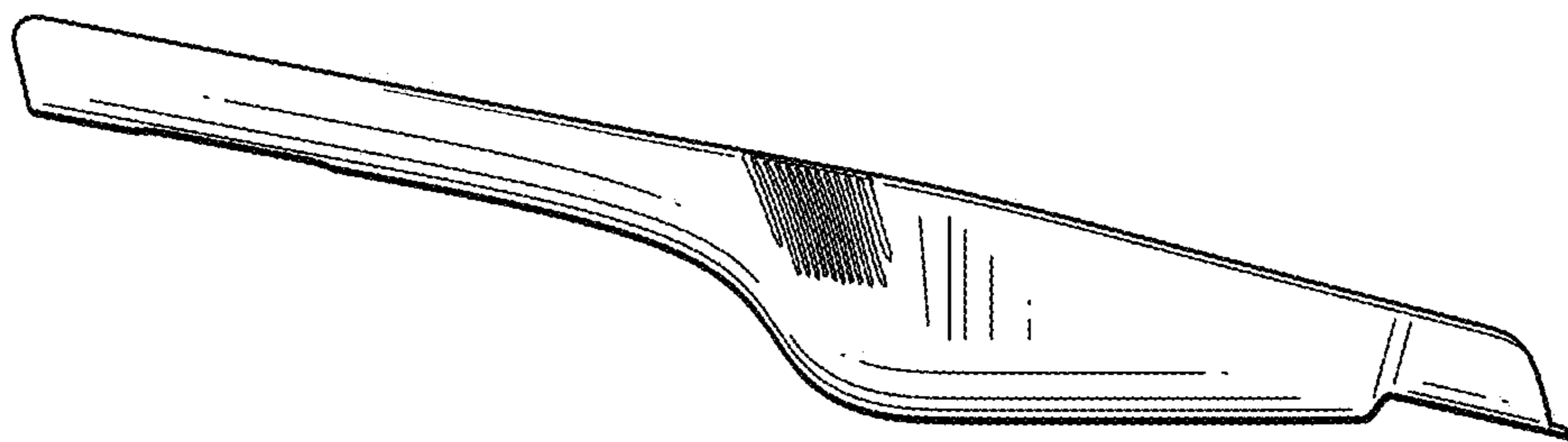

FIG. 7

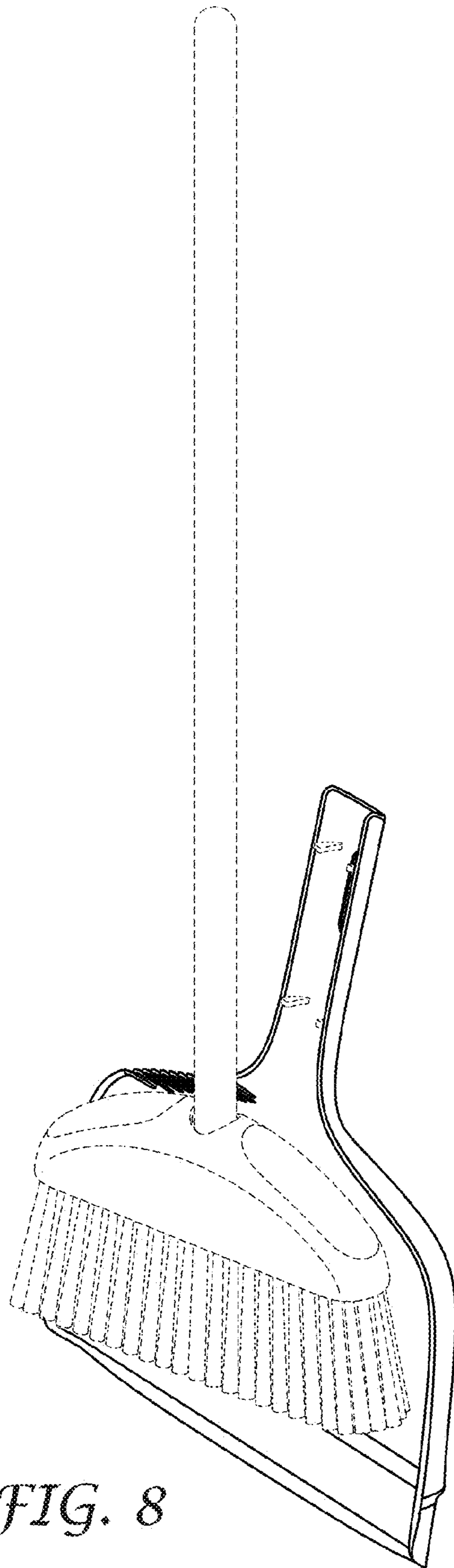

FIG. 8