



US00D687199S

(12) **United States Design Patent**
Chen

(10) **Patent No.:** **US D687,199 S**
(45) **Date of Patent:** **** Jul. 30, 2013**

(54) **CLEANING IMPLEMENT HOLDER**

(76) Inventor: **James Chen**, Chino, CA (US)

(**) Term: **14 Years**

(21) Appl. No.: **29/387,383**

(22) Filed: **Mar. 11, 2011**

(51) **LOC (9) Cl.** **04-01**

(52) **U.S. Cl.**
USPC **D32/40**

(58) **Field of Classification Search**
USPC D32/40; 15/209.1, 229.11, 244.1–244.4,
15/147.1, 146, 104.94; D8/DIG. 7; 16/444,
16/DIG. 19

See application file for complete search history.

(56) **References Cited**

U.S. PATENT DOCUMENTS

5,020,182	A *	6/1991	Engel	15/145
D351,285	S *	10/1994	Joyner et al.	D4/120
5,875,511	A *	3/1999	Nejdl	15/176.1
D604,918	S *	11/2009	Thomas et al.	D32/40
D608,965	S *	1/2010	Tanaka et al.	D32/40
8,286,295	B2 *	10/2012	Minkler et al.	15/145

* cited by examiner

Primary Examiner — Robin V Webster

(74) *Attorney, Agent, or Firm* — James A. Italia; Italia IP

(57) **CLAIM**

The ornamental design for a cleaning implement holder, as shown and described.

DESCRIPTION

This application claims the benefit of the filing date of U.S. Non-Provisional patent application Ser. No. 12/543,702, filed Aug. 19, 2009, and U.S. Non-Provisional patent application Ser. No. 12/859,151, filed Aug. 18, 2010.

FIG. 1 is a perspective view of a cleaning implement holder, showing my new design;

FIG. 2 is a front elevational view of a cleaning implement holder;

FIG. 3 is a rear elevational view of a cleaning implement holder;

FIG. 4 is a right-side elevational view of a cleaning implement holder;

FIG. 5 is a left-side elevational view of a cleaning implement holder;

FIG. 6 is a top plan view of a cleaning implement holder; and, FIG. 7 is a bottom plan view of a cleaning implement holder.

The broken lines form no part of the claimed design.

1 Claim, 3 Drawing Sheets

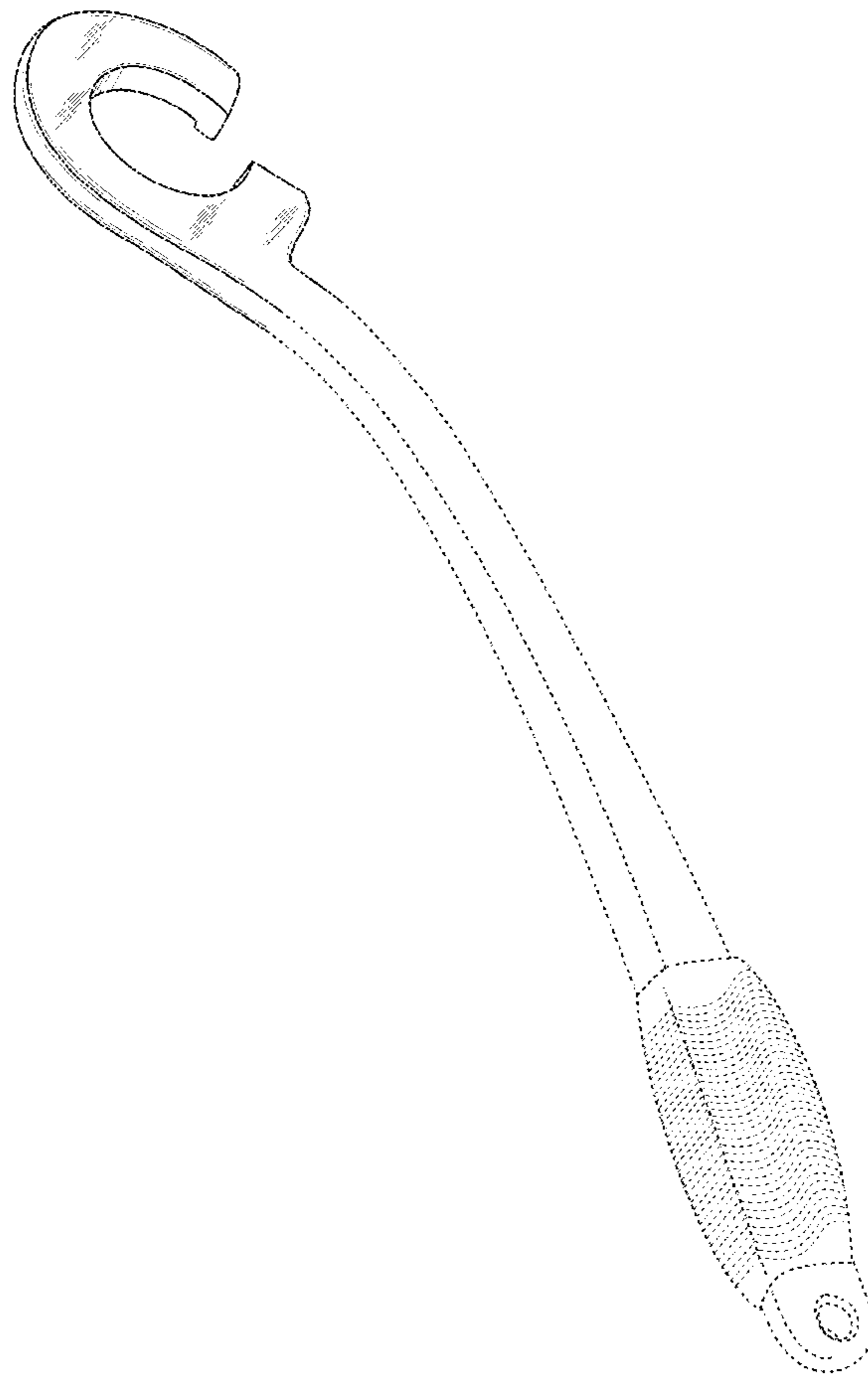

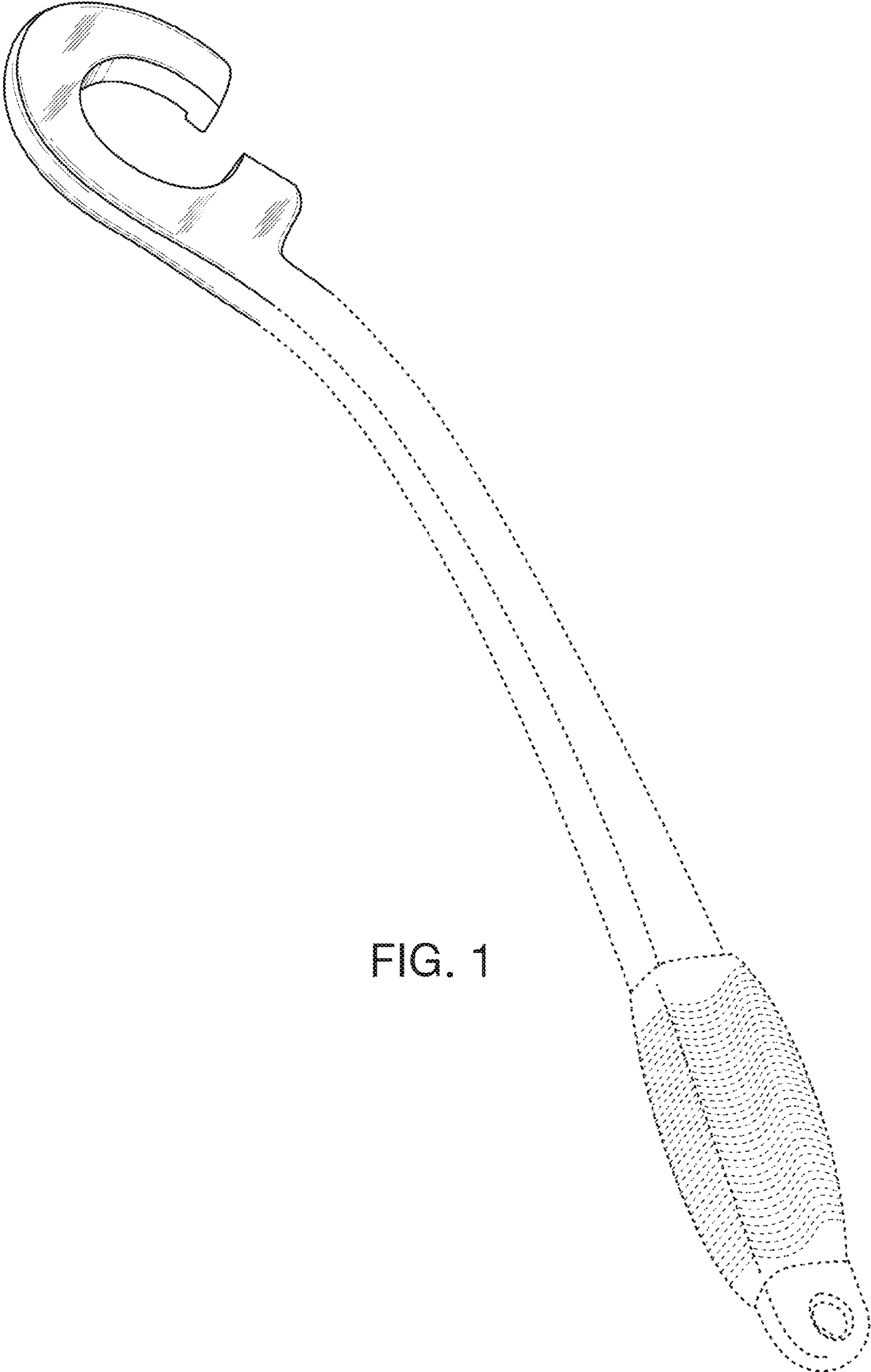

FIG. 1

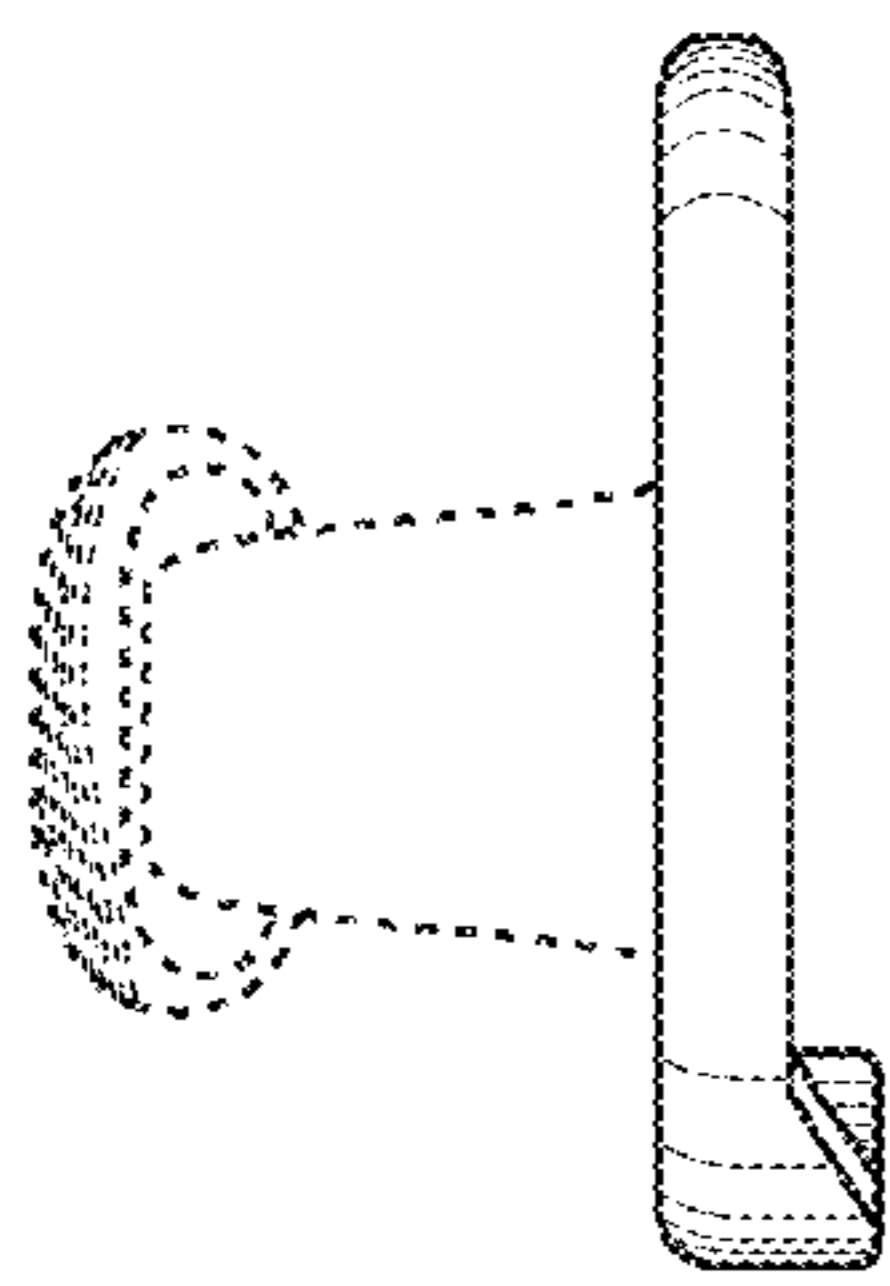

FIG. 2

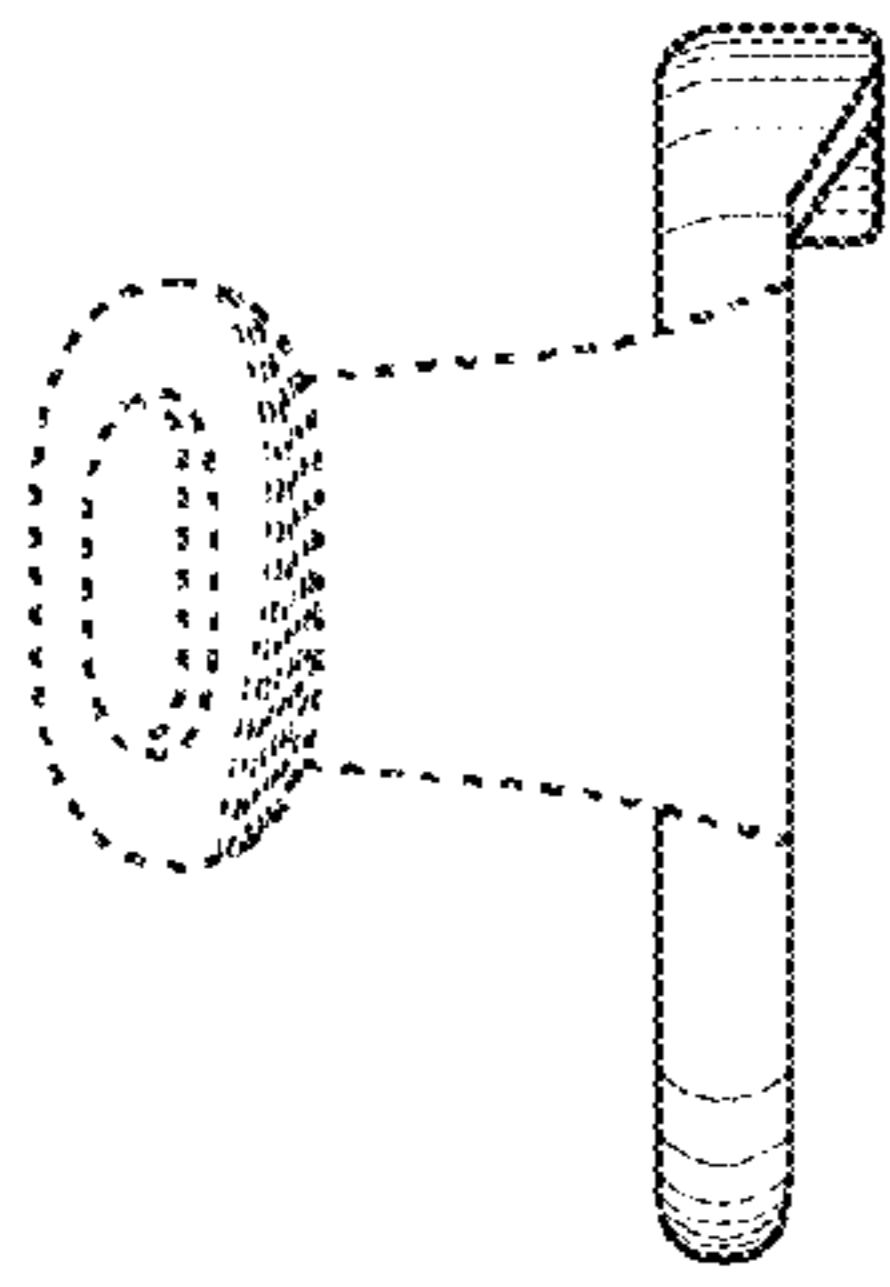

FIG. 3

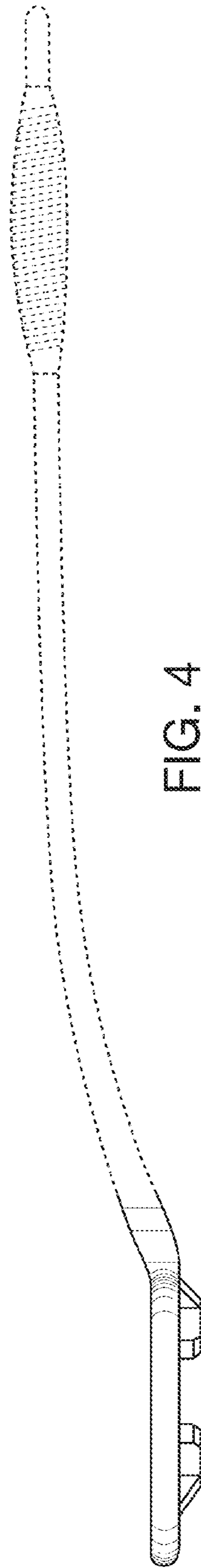

FIG. 4

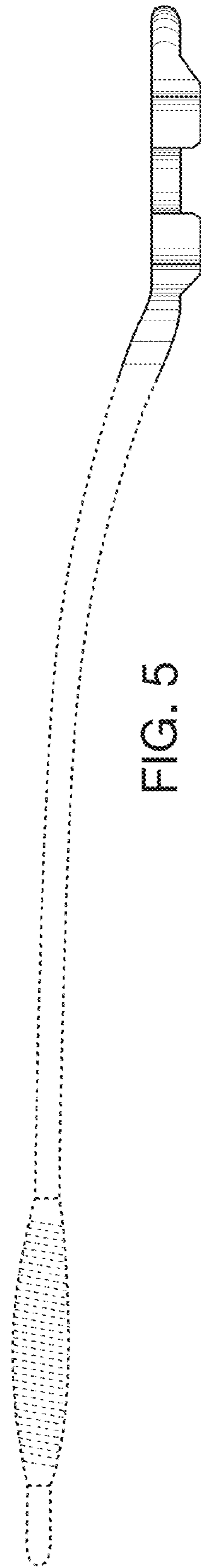

FIG. 5

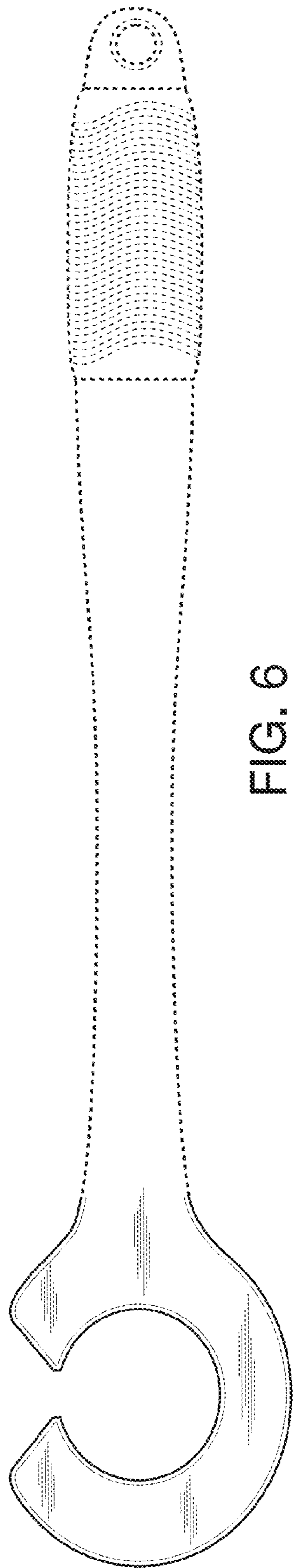

FIG. 6

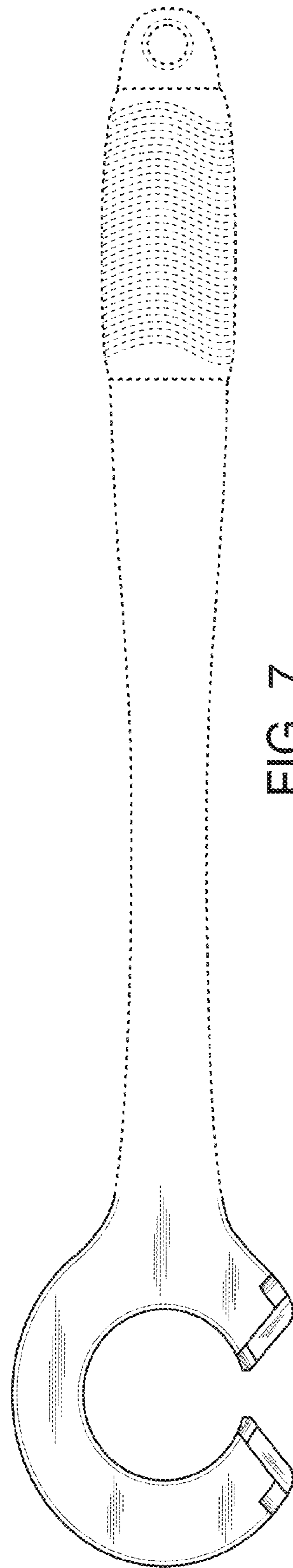

FIG. 7