



US00D687187S

(12) **United States Design Patent**
Lai

(10) **Patent No.:** **US D687,187 S**

(45) **Date of Patent:** **** Jul. 30, 2013**

(54) **COSMETIC CASE**

D621,548 S * 8/2010 Chen D28/83
D642,743 S * 8/2011 Shteytsel D28/83

(71) Applicant: **Chin-Chun Lai**, New Taipei (TW)

* cited by examiner

(72) Inventor: **Chin-Chun Lai**, New Taipei (TW)

Primary Examiner — Jennifer Rivard

(73) Assignee: **Chao Ling Chemical Industry Co., Ltd.**, New Taipei (TW)

(74) *Attorney, Agent, or Firm* — Leong C. Lei

(**) Term: **14 Years**

(57) **CLAIM**

The ornamental design for a cosmetic case, as shown and described.

(21) Appl. No.: **29/447,673**

DESCRIPTION

(22) Filed: **Mar. 5, 2013**

FIG. 1 is a front perspective view of a cosmetic case showing my new design;

(51) **LOC (9) Cl.** **28-03**

FIG. 2 is a front elevational view thereof;

(52) **U.S. Cl.**
USPC **D28/83**

FIG. 3 is a rear elevational view thereof;

(58) **Field of Classification Search**
USPC D28/76-84; 206/581, 823, 1.8;
132/286-318, 320, 319; D19/35-36
See application file for complete search history.

FIG. 4 is a left elevational view thereof;

FIG. 5 is a right elevational view thereof;

FIG. 6 is a top plan view thereof;

FIG. 7 is a bottom plan view thereof, with a stand engaged;

FIG. 8 is another perspective view thereof, showing the status while in use; and,

FIG. 9 is another perspective view thereof, showing the status while in use.

(56) **References Cited**

The dotted line showing of the stand and internal storage compartments is for illustrative purposes only and forms no part of the claimed design.

U.S. PATENT DOCUMENTS

4,526,273 A * 7/1985 Tsuji et al. 206/229
D485,018 S * 1/2004 Beilman D28/77

1 Claim, 9 Drawing Sheets

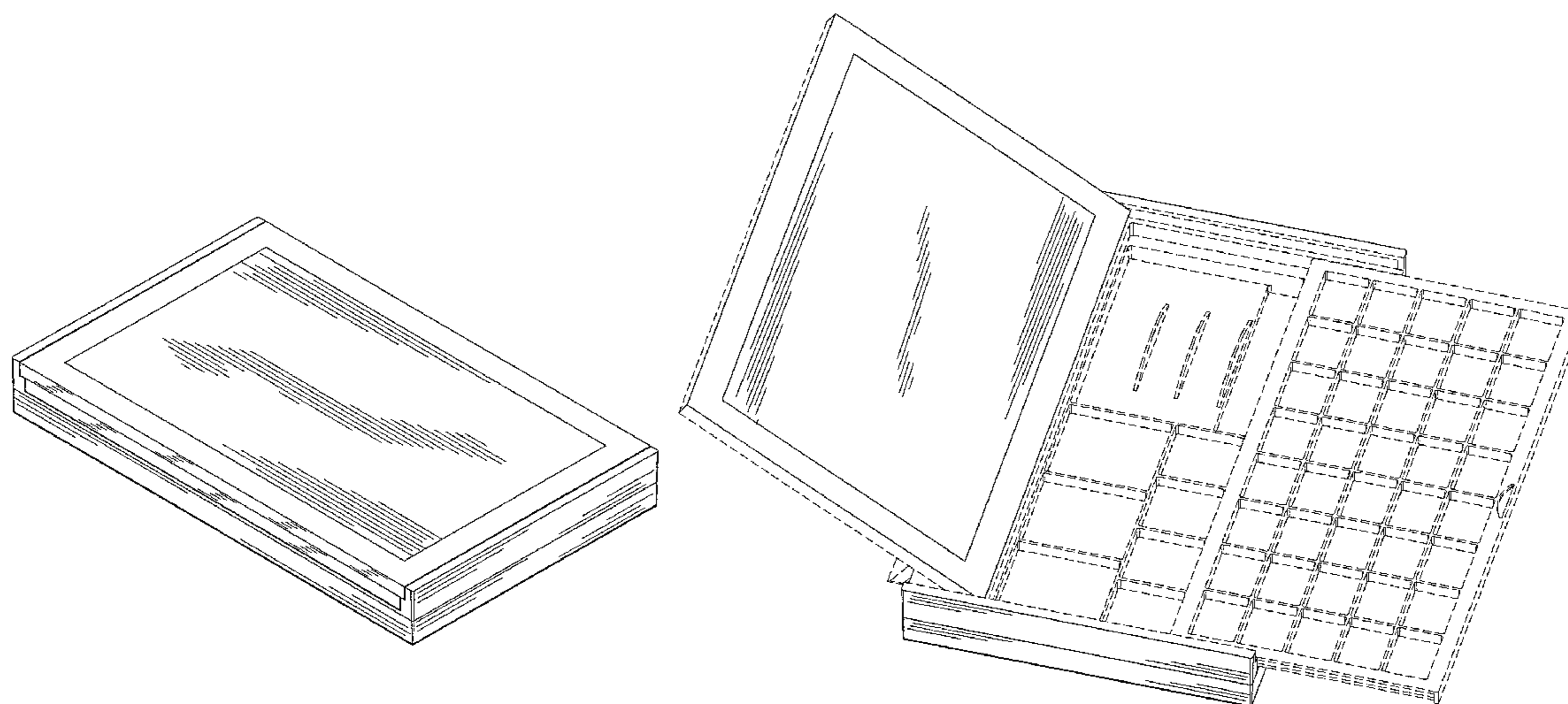

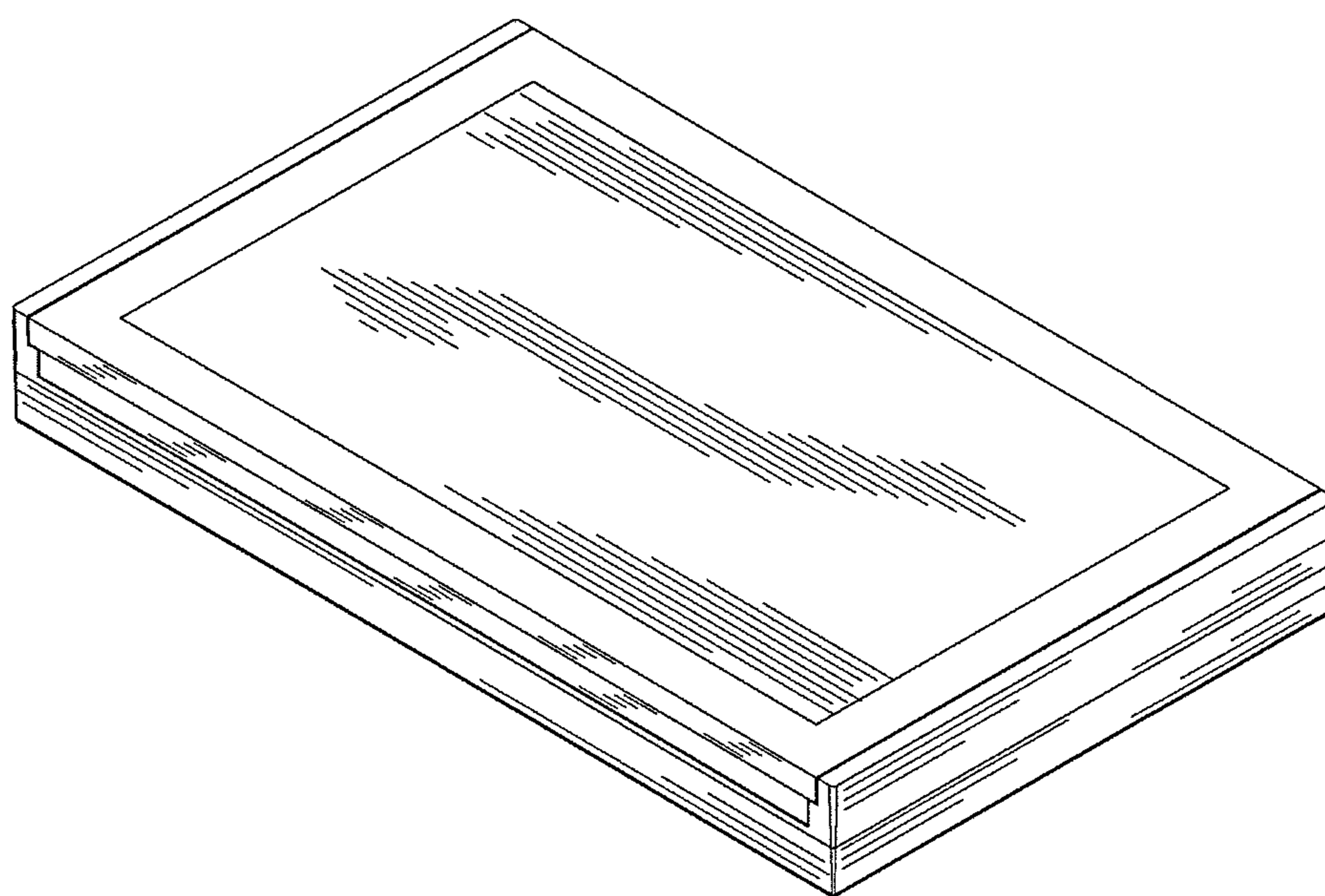

FIG. 1

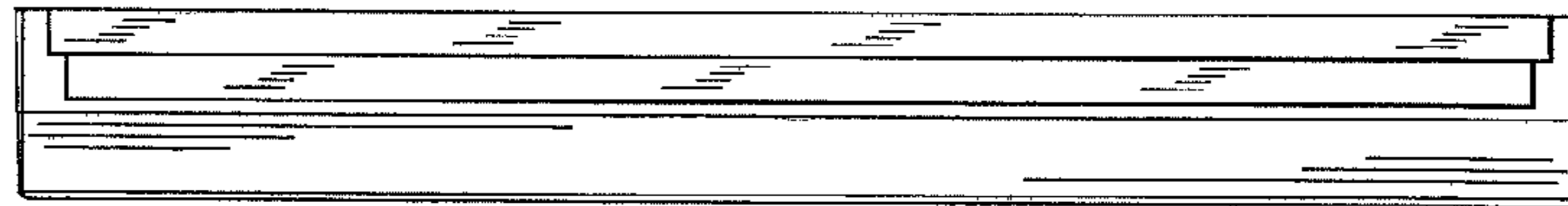

FIG.2

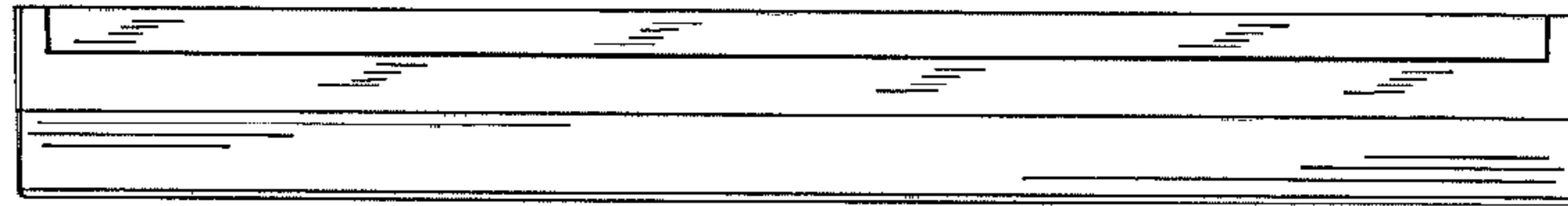

FIG.3

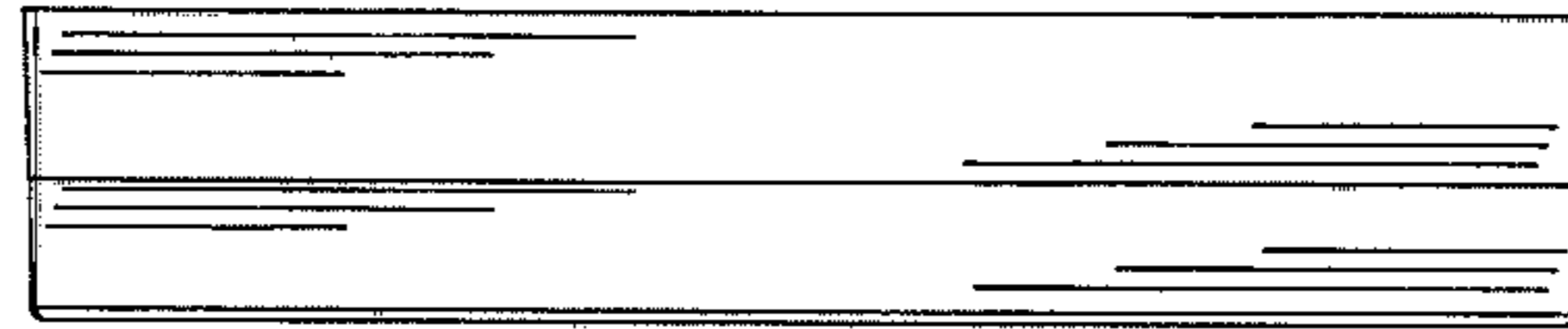

FIG.4

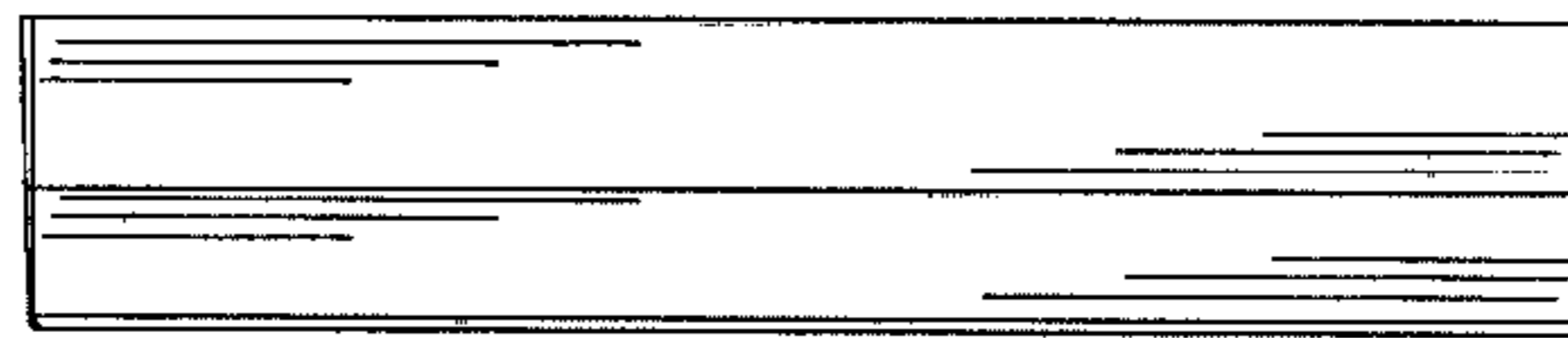

FIG. 5

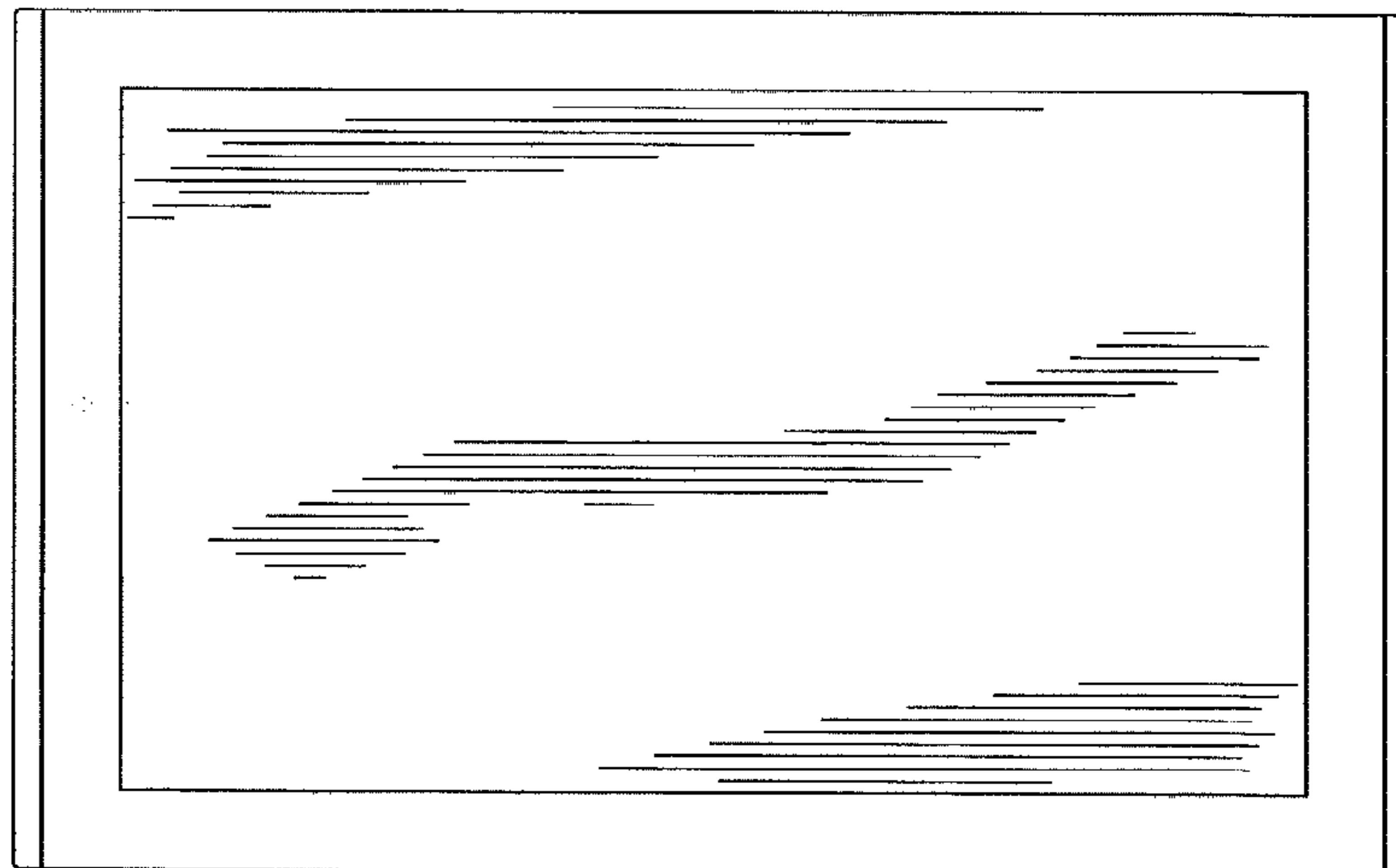

FIG.6

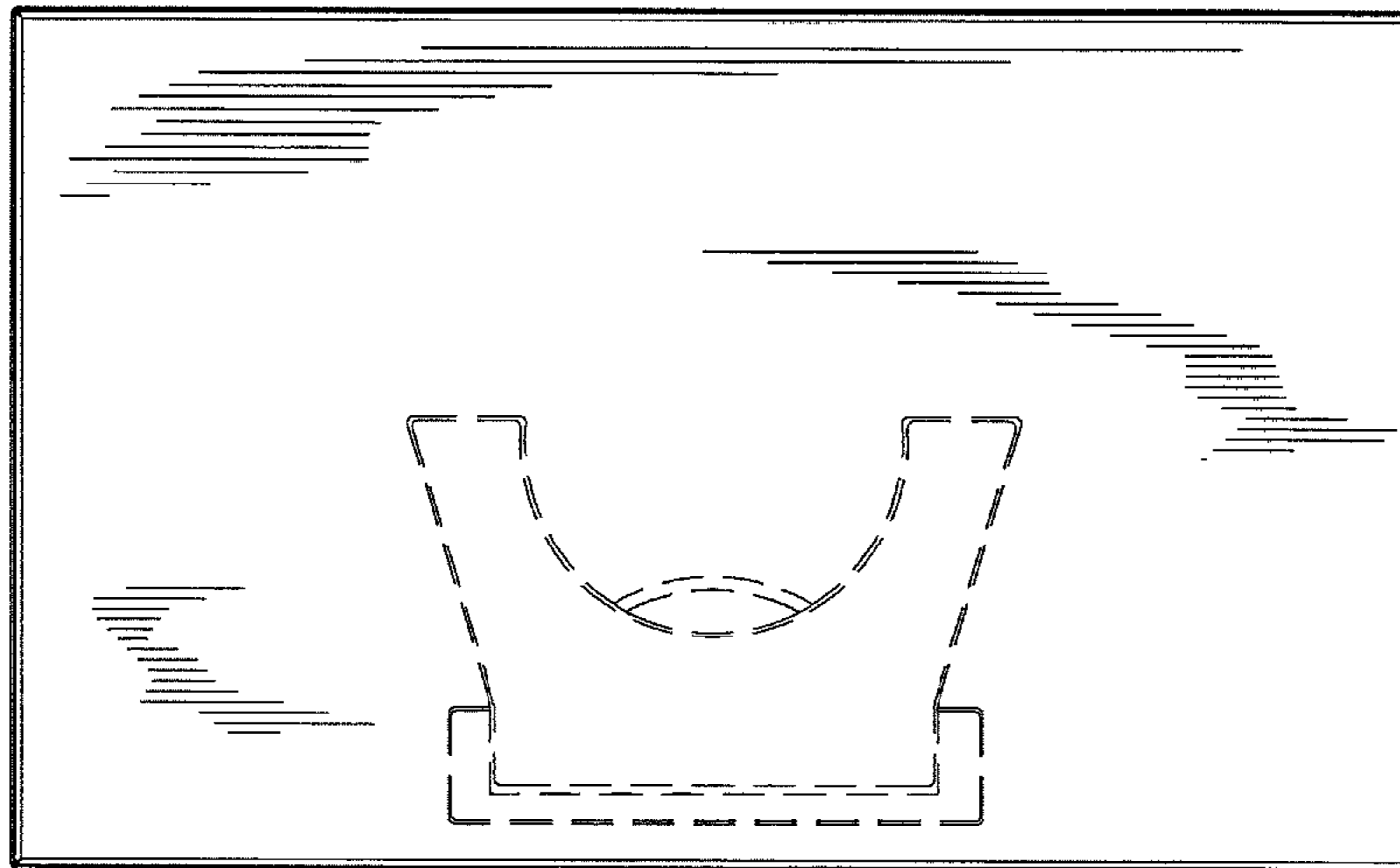

FIG. 7

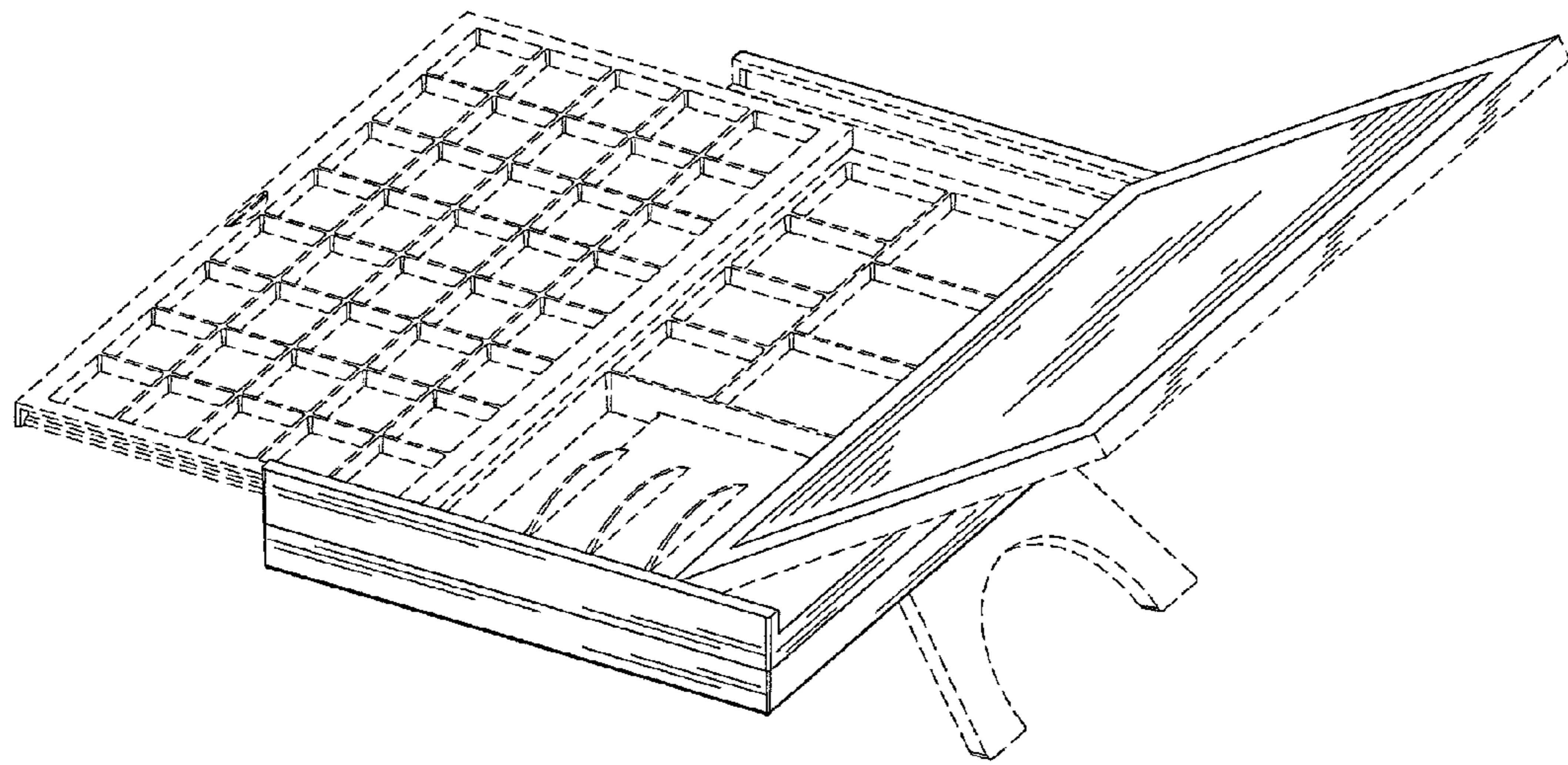

FIG.8

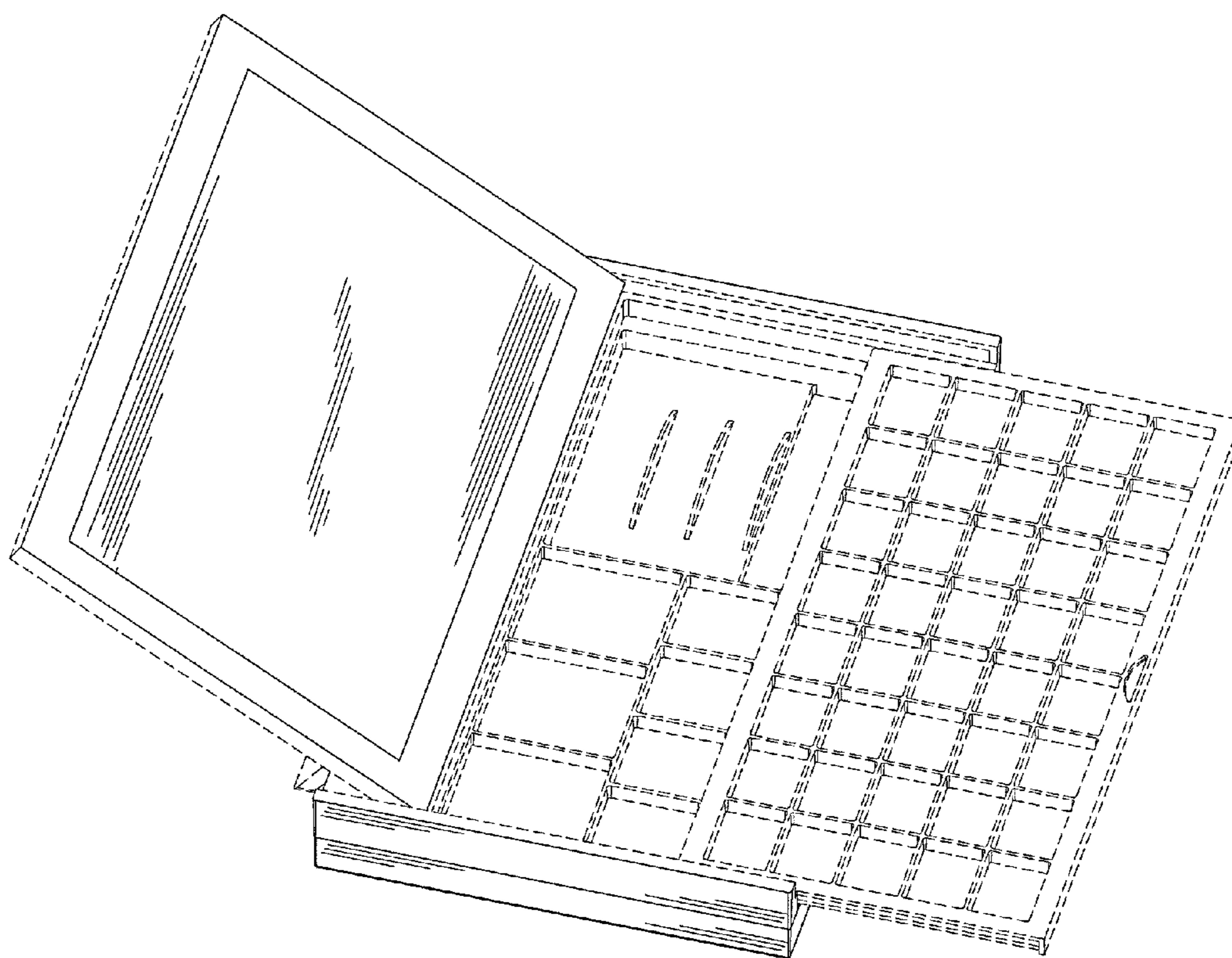

FIG.9