



US00D687184S

(12) **United States Design Patent**
Silva

(10) **Patent No.:** **US D687,184 S**

(45) **Date of Patent:** **** Jul. 30, 2013**

(54) **COVERED HAIR CLIP**

(57) **CLAIM**

The ornamental design for a covered hair clip, as shown and described.

(76) Inventor: **David Alan Silva**, Reno, NV (US)

DESCRIPTION

(**) Term: **14 Years**

FIG. 1 is a front view of my covered hair clip;
 FIG. 2 is the opposite side front view of my covered hair clip thereof;
 FIG. 3 is a perspective view thereof;
 FIG. 4 is a side view thereof; the opposite side is a mirror image thereof; the broken lines are for environmental purposes only and form no part of the claimed design
 FIG. 5 is a top view thereof;
 FIG. 6 is a bottom view thereof;
 FIG. 7 is a front view of my covered hair clip with more teeth;
 FIG. 8 is the opposite side front view of my covered hair clip with more teeth thereof;
 FIG. 9 is a perspective view with more teeth thereof;
 FIG. 10 is a side view with more teeth thereof; the opposite side is a mirror image thereof; the broken lines are for environmental purposes only and form no part of the claimed design
 FIG. 11 is a top view with more teeth thereof;
 FIG. 12 is a bottom view with more teeth thereof;
 FIG. 13 is a front view of my covered hair clip with fewer teeth;
 FIG. 14 is the opposite side front view of my covered hair clip with fewer teeth thereof;
 FIG. 15 is a perspective view with fewer teeth thereof;
 FIG. 16 is a side view with fewer teeth thereof; the opposite side is a mirror image thereof; the broken lines are for environmental purposes only and form no part of the claimed design
 FIG. 17 is a top view with fewer teeth thereof; and,
 FIG. 18 is a bottom view with fewer teeth thereof.

(21) Appl. No.: **29/315,614**

(22) Filed: **Jul. 9, 2009**

(51) **LOC (9) Cl.** **28-03**

(52) **U.S. Cl.**
USPC **D28/40**

(58) **Field of Classification Search**
USPC D28/21-34, 39-43; 132/101, 126,
132/128-131, 144, 148, 219, 275-284
See application file for complete search history.

(56) **References Cited**

U.S. PATENT DOCUMENTS

D379,555	S	*	5/1997	Fergusson	D28/41
D384,786	S	*	10/1997	LaFauci	D2/501
D410,302	S	*	5/1999	Yasuda	D28/40
D430,956	S	*	9/2000	Sartena	D28/92
D431,689	S	*	10/2000	Sartena	D28/92
6,135,125	A	*	10/2000	Sartena	132/275
D435,940	S	*	1/2001	Sartena	D28/92
D486,605	S	*	2/2004	Walker et al.	D28/40
D526,744	S	*	8/2006	Siilva	D28/40

* cited by examiner

Primary Examiner — Zenia Bennett

1 Claim, 9 Drawing Sheets

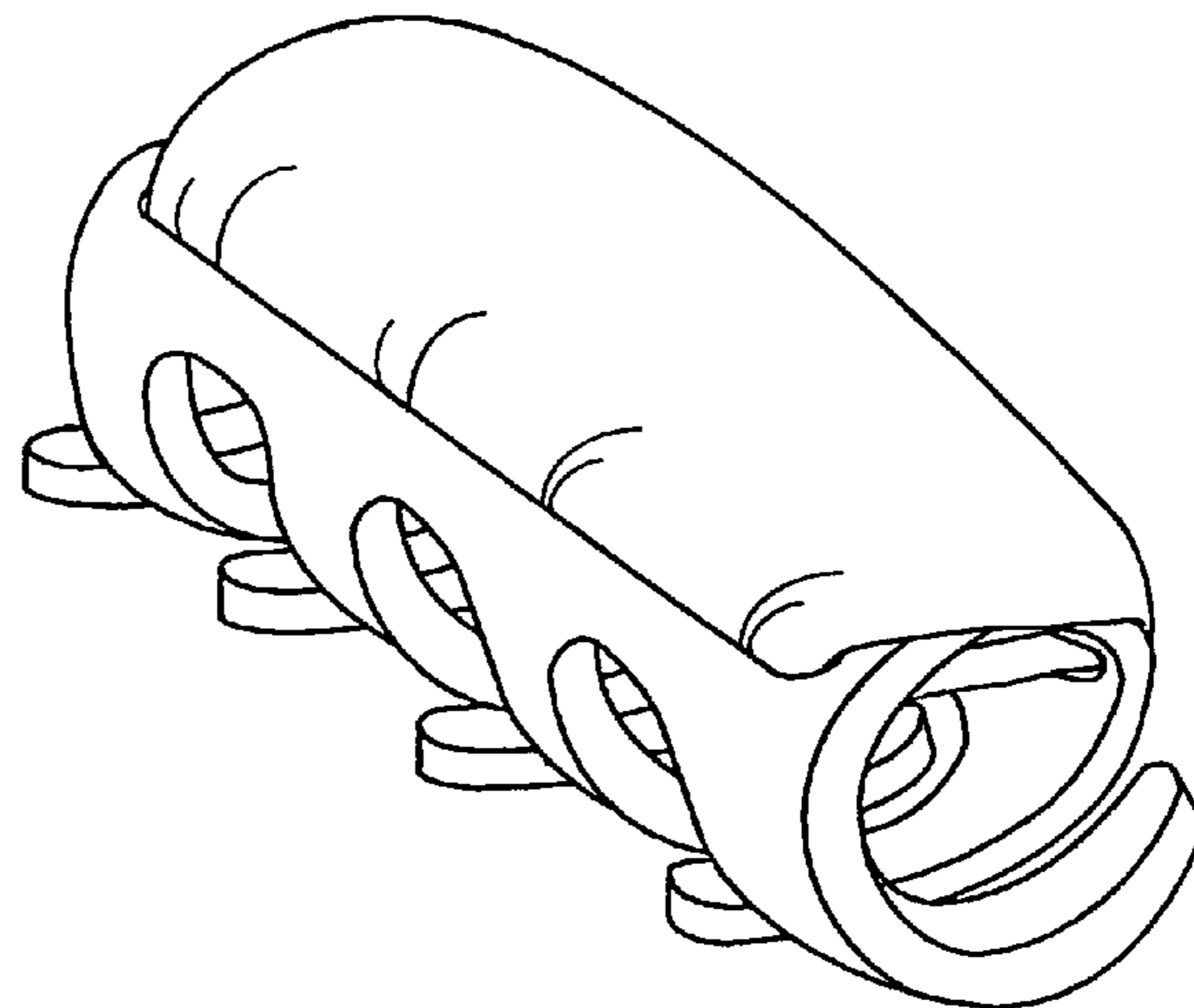
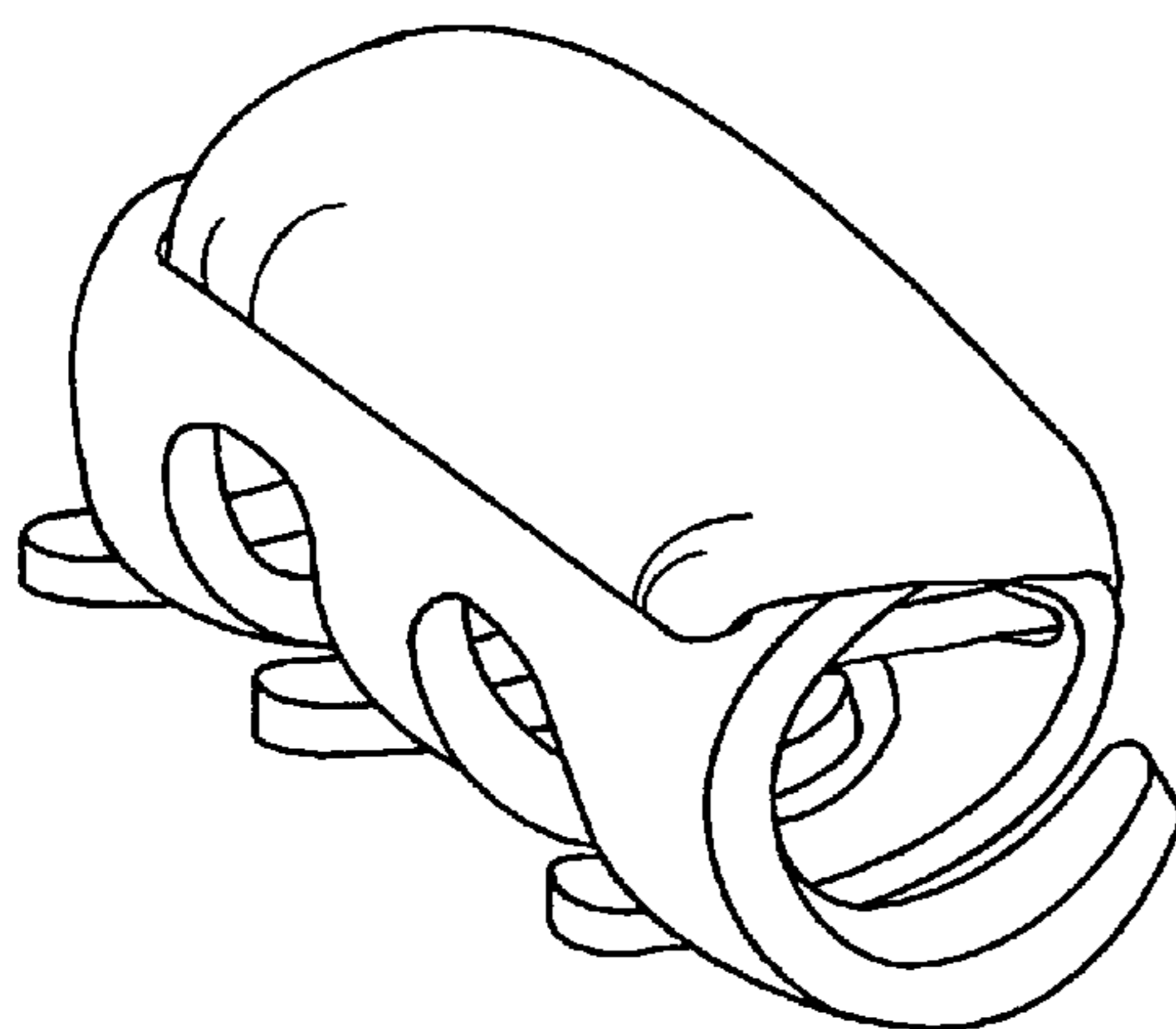

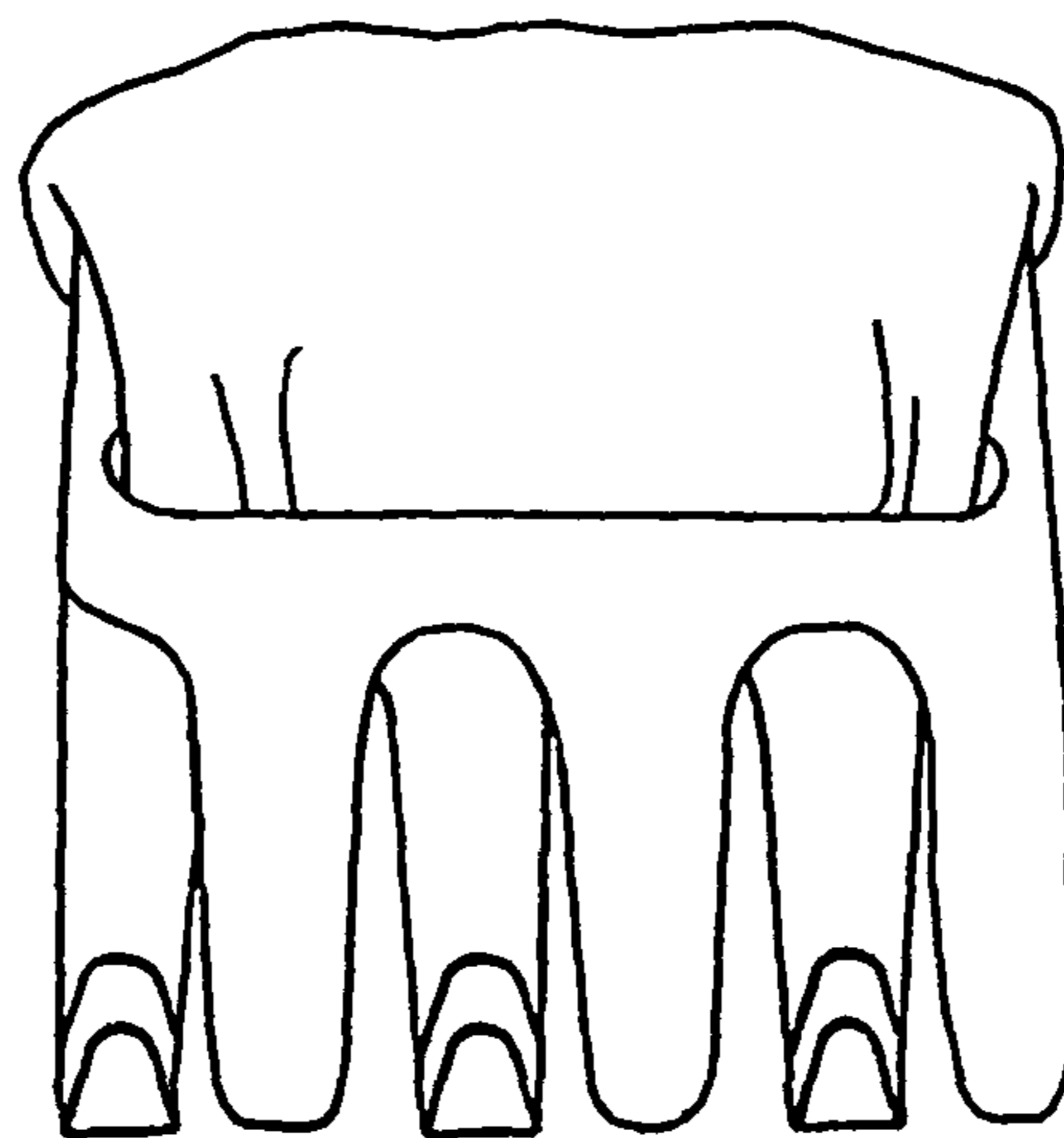

FIG 1

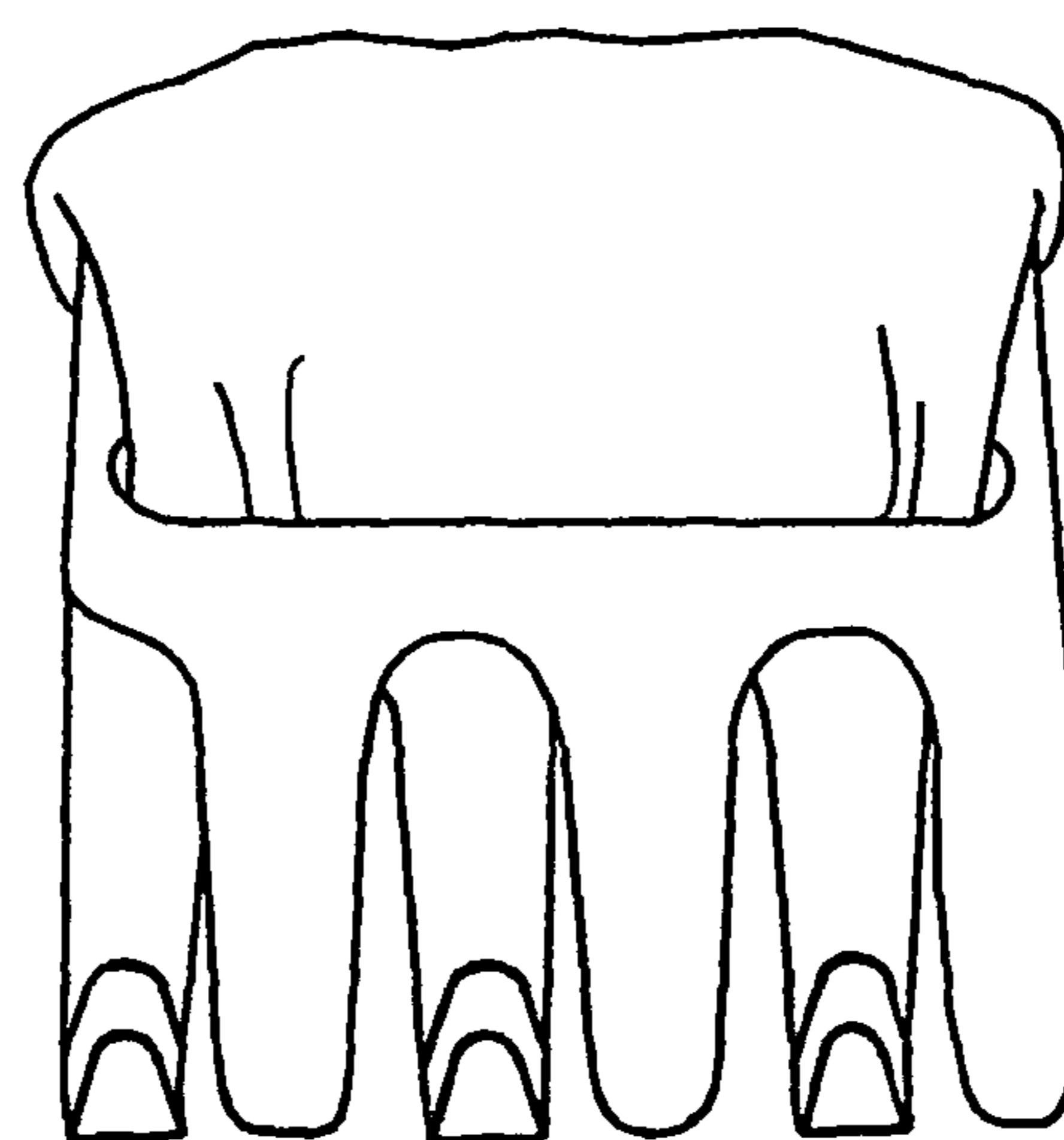

FIG 2

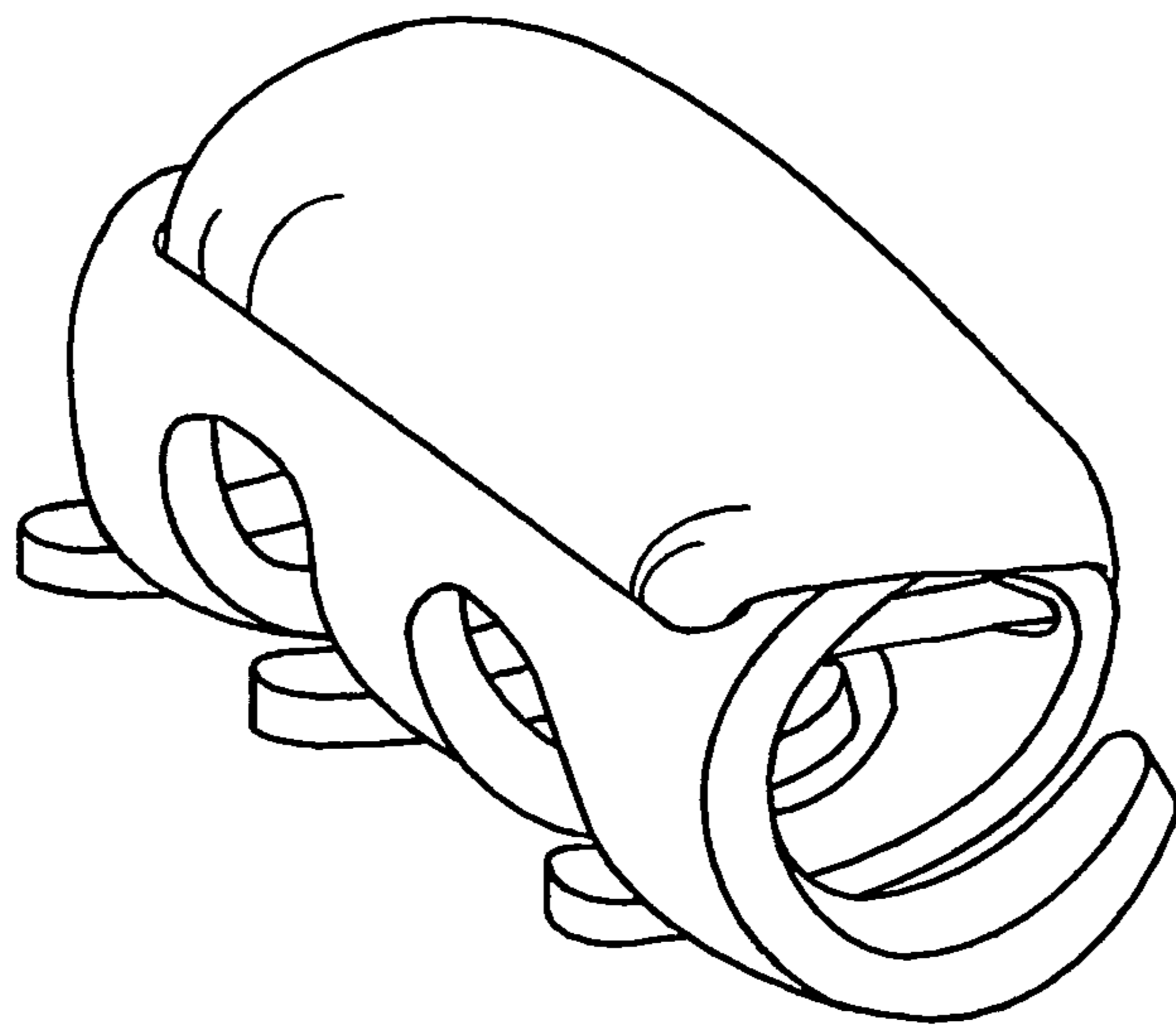

FIG 3

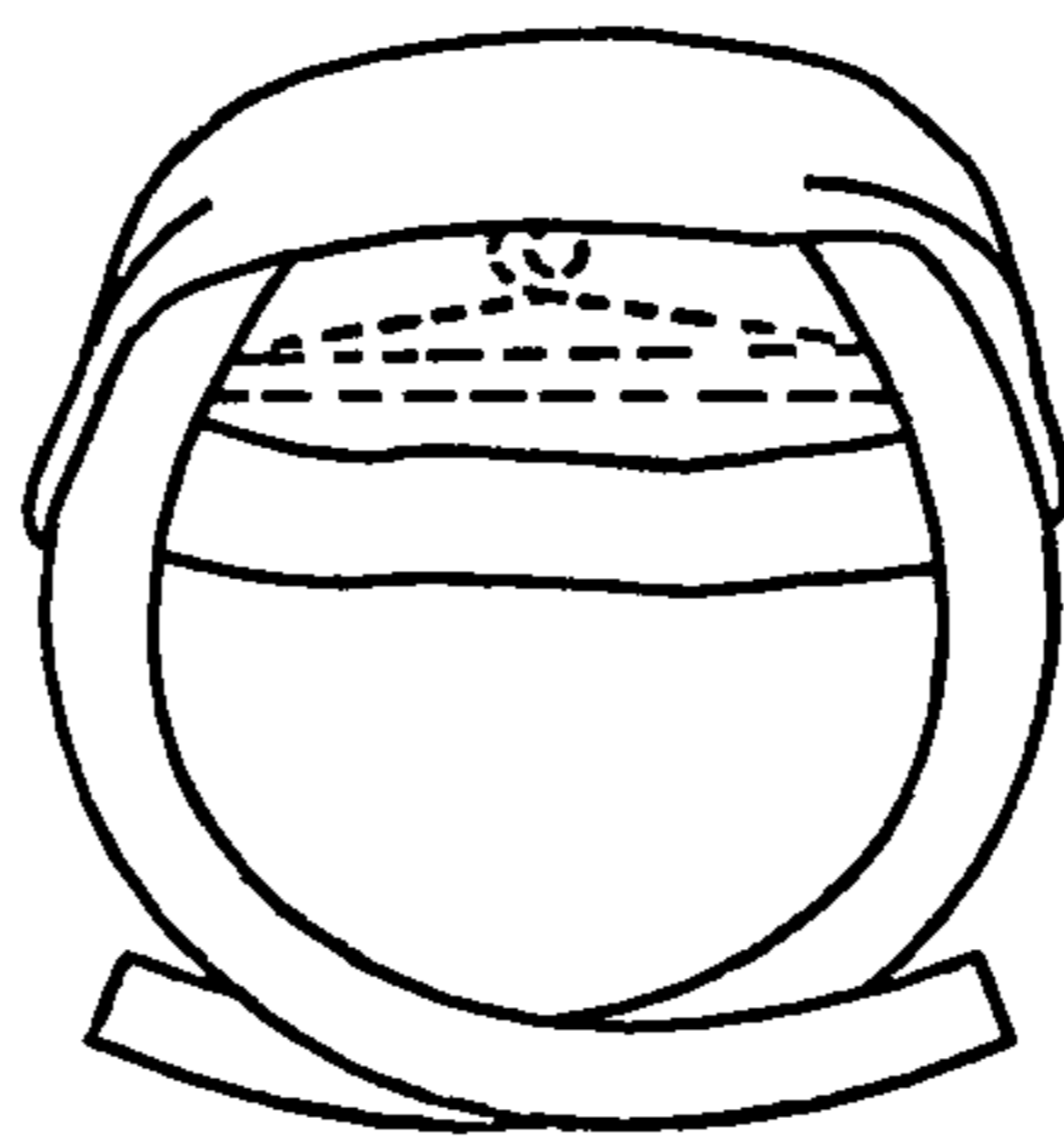

FIG 4

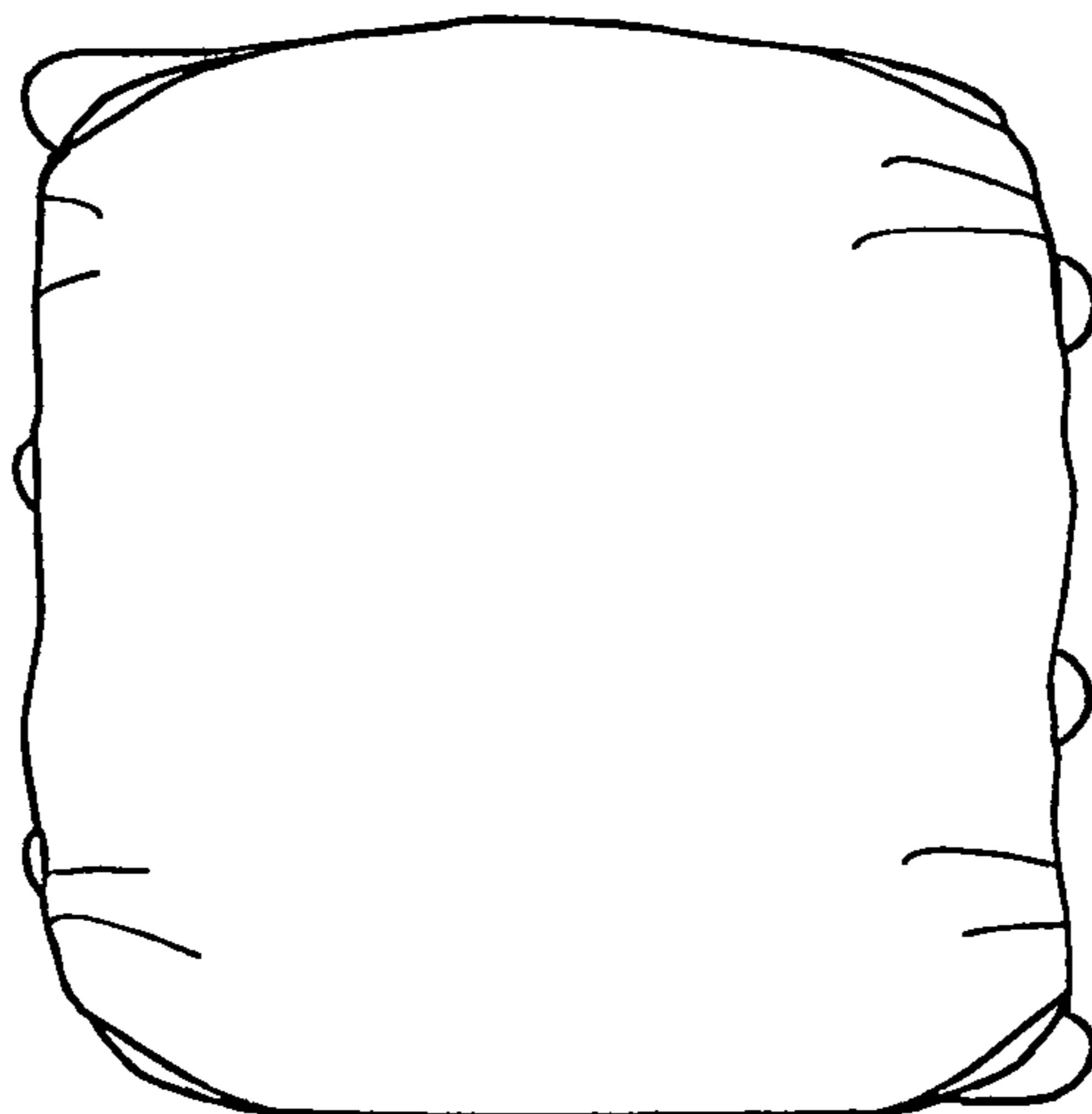

FIG 5

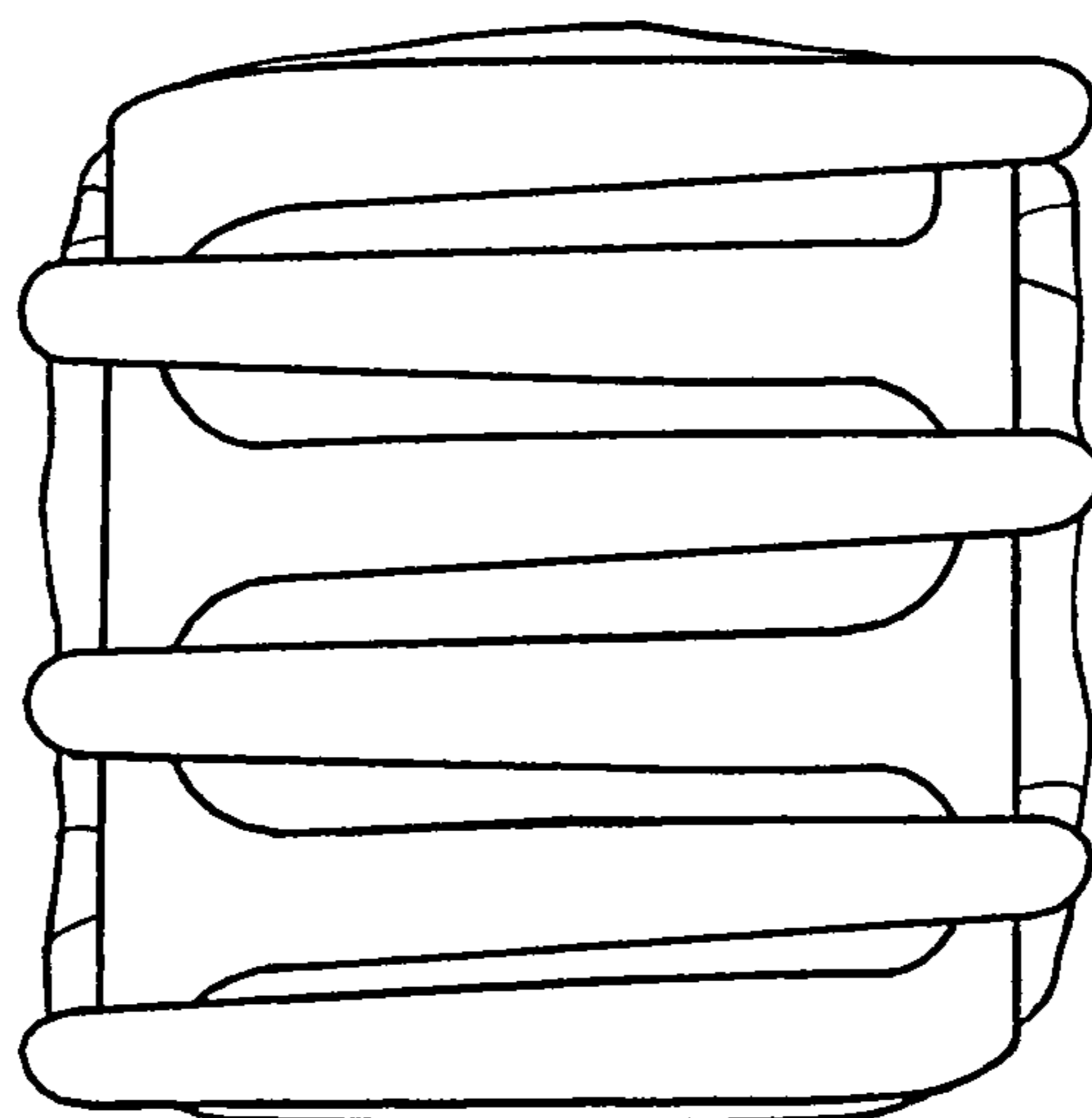

FIG 6

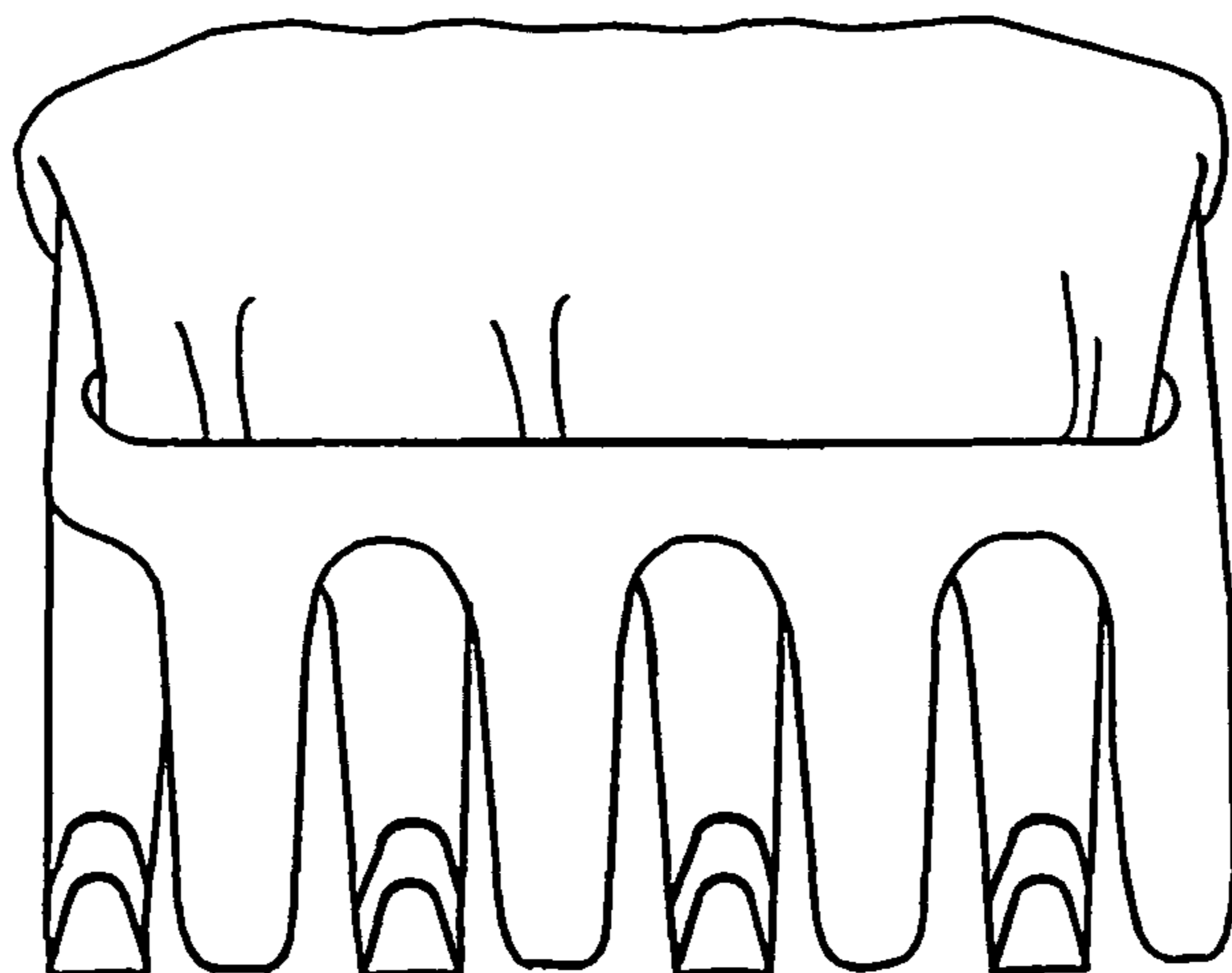

FIG 7

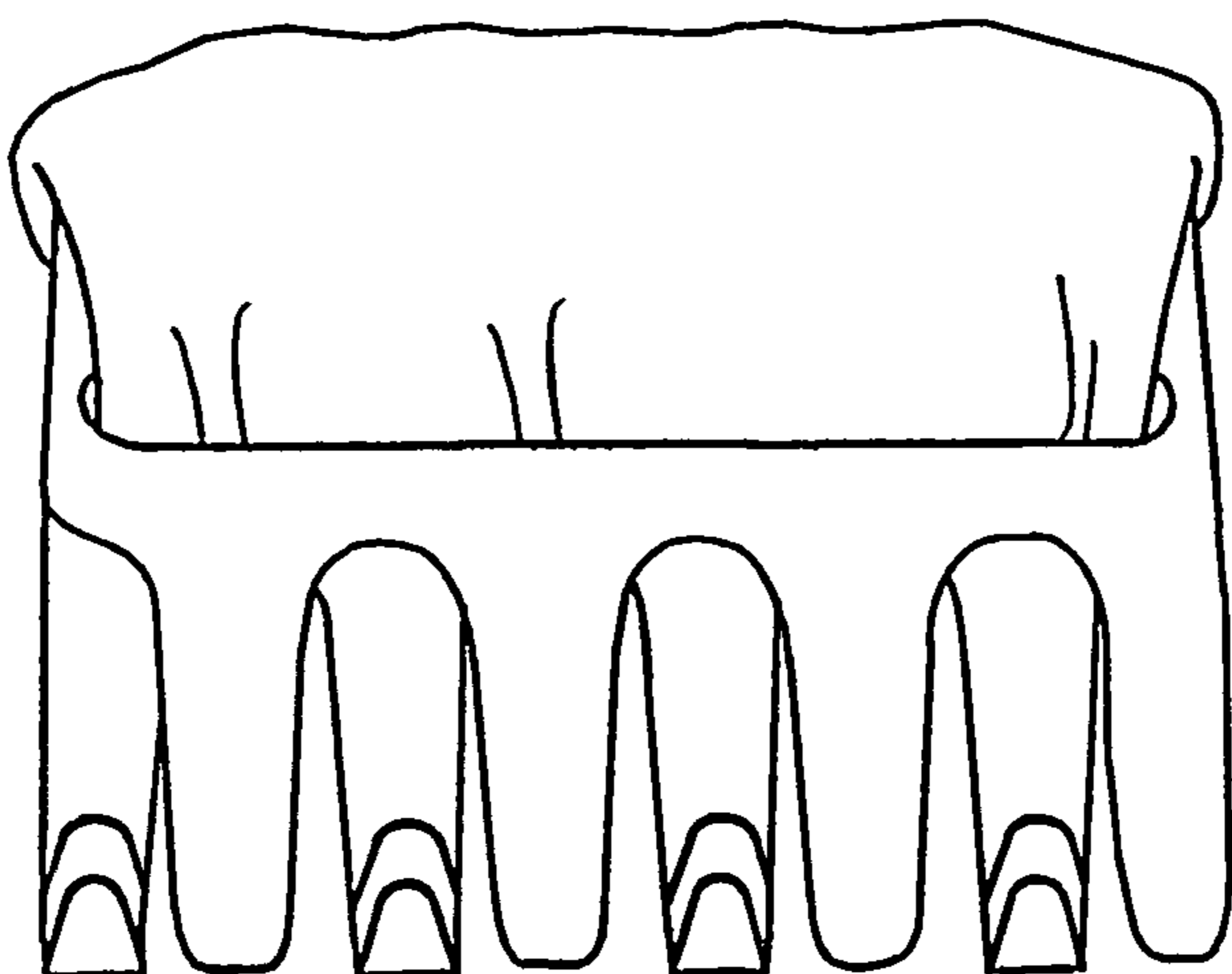

FIG 8

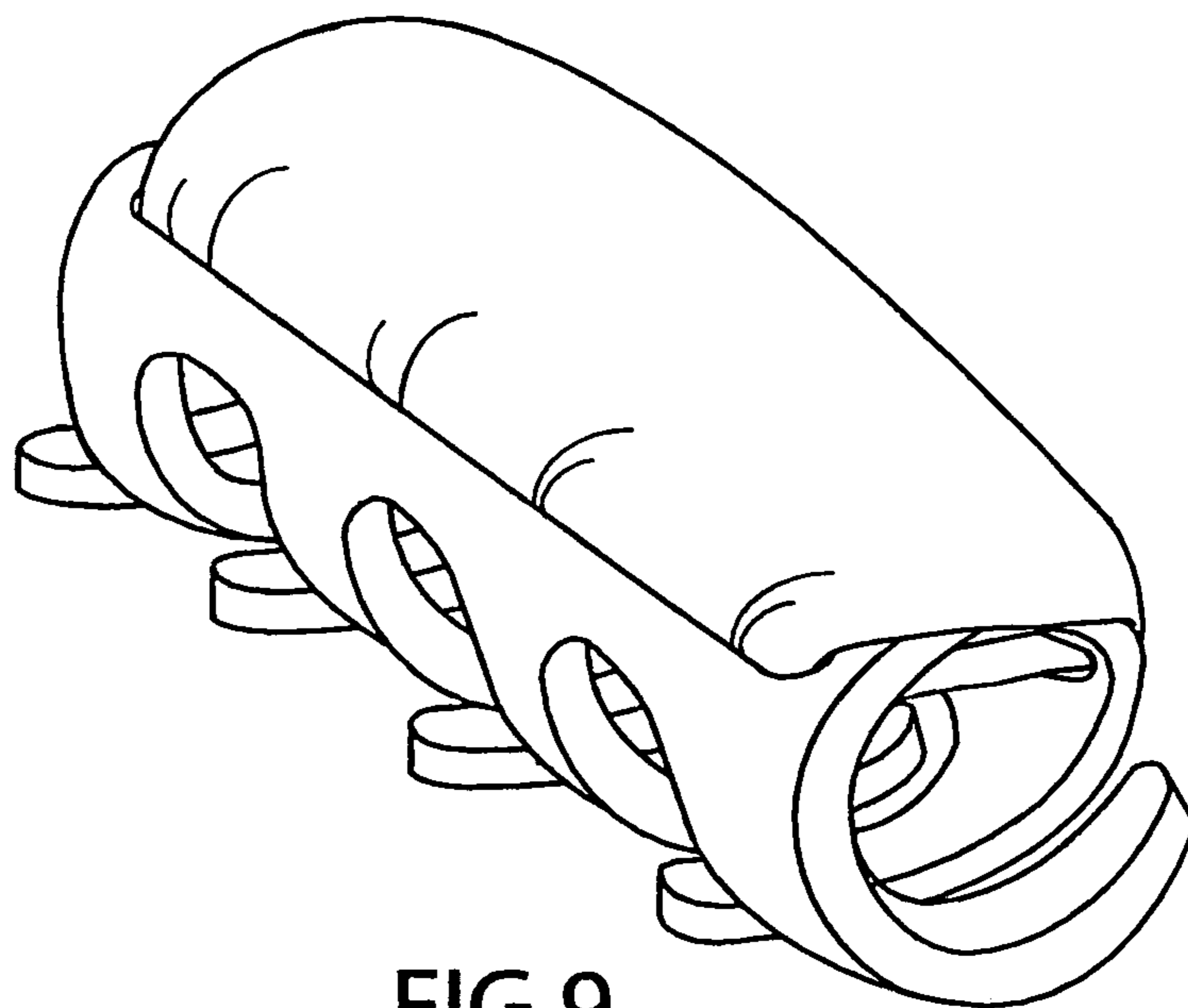

FIG 9

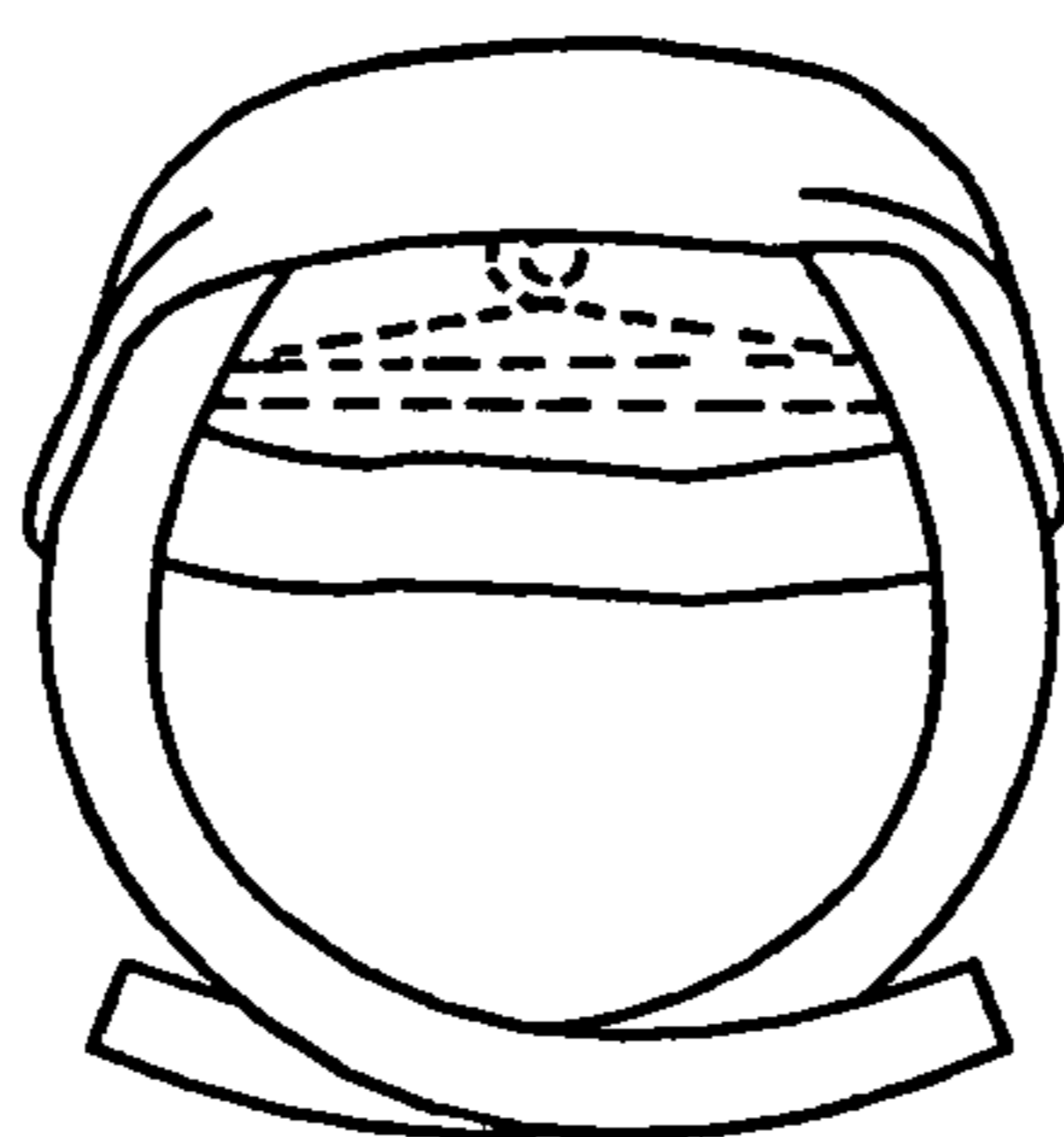

FIG 10

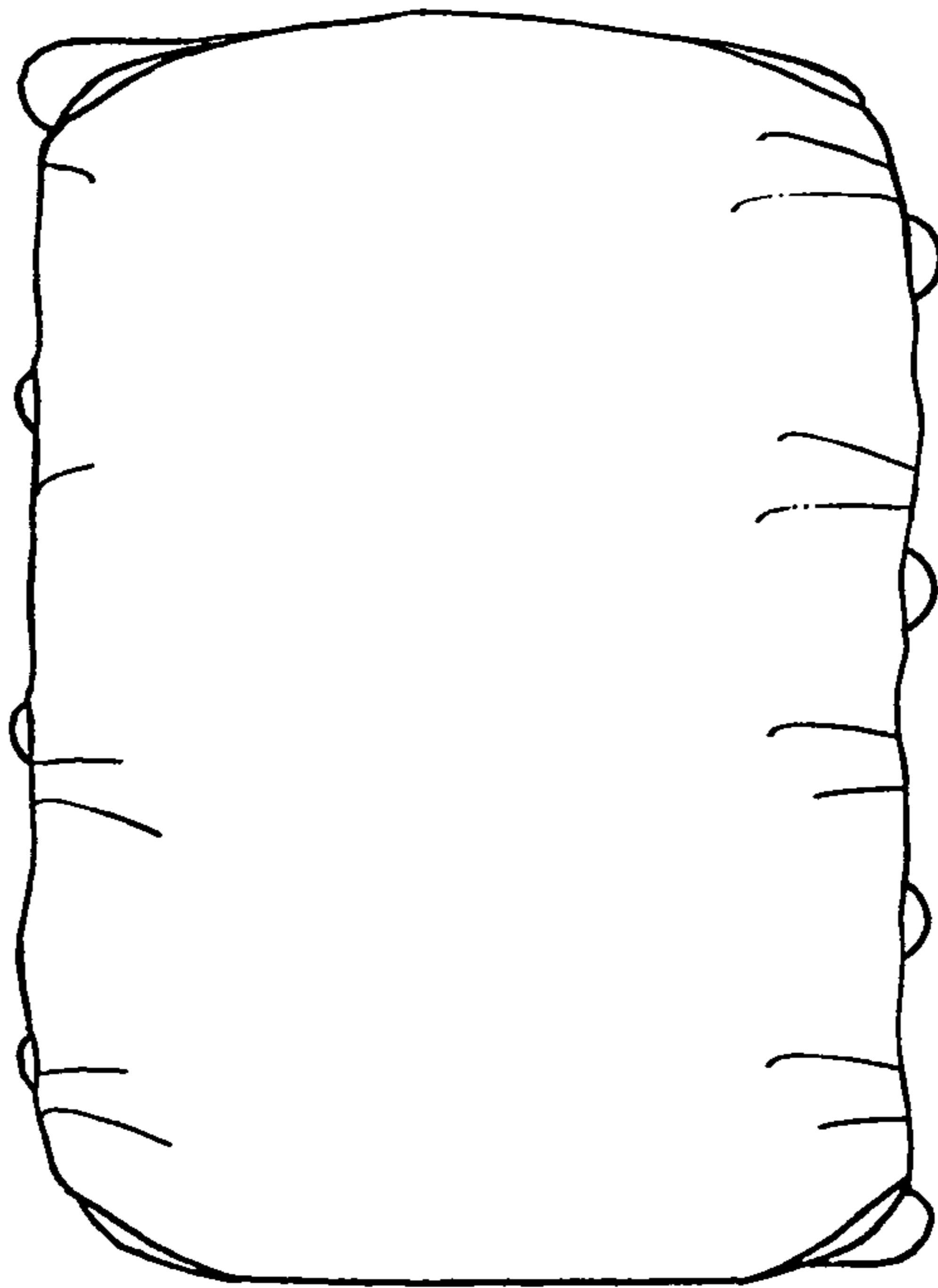

FIG 11

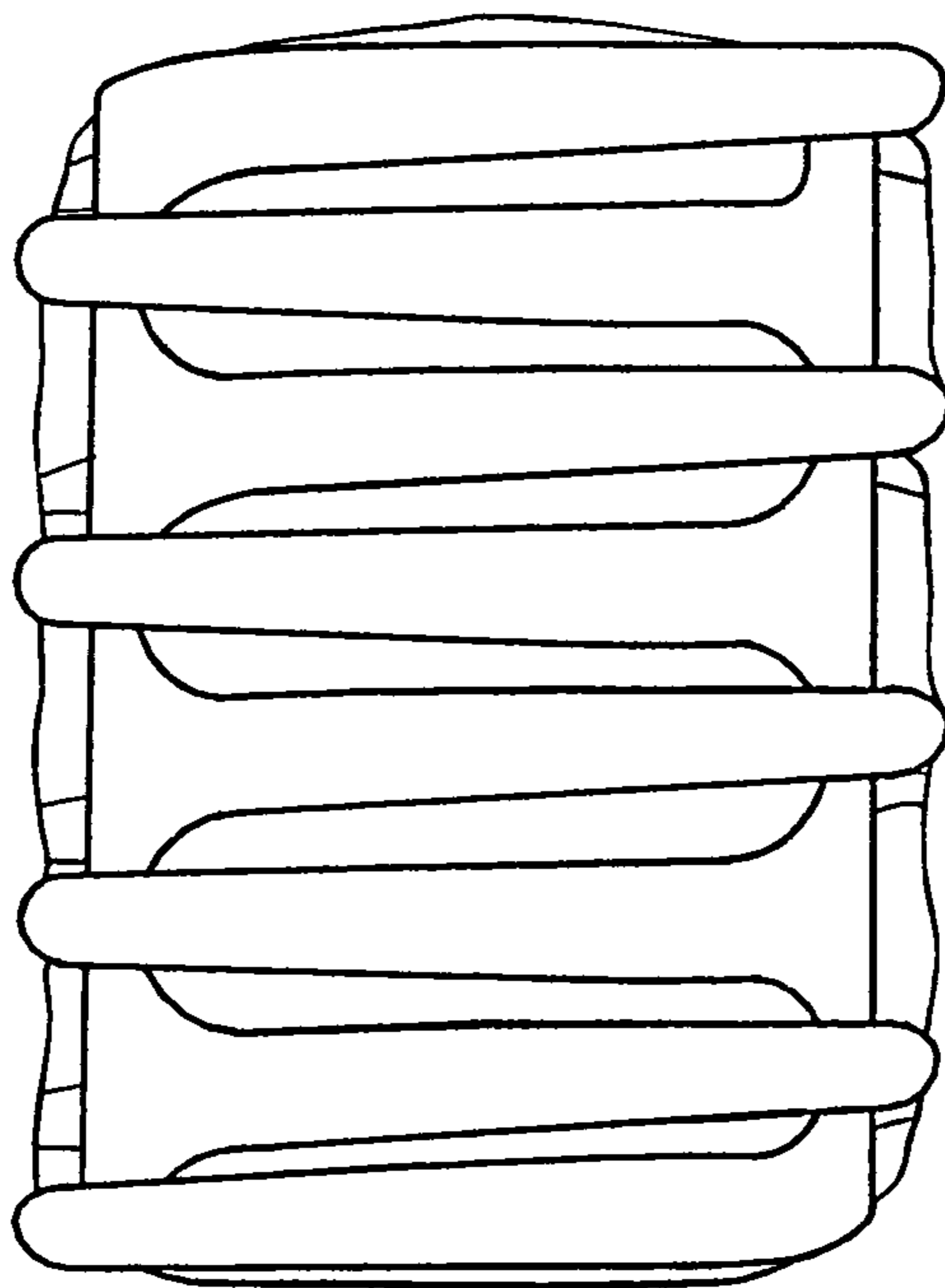

FIG 12

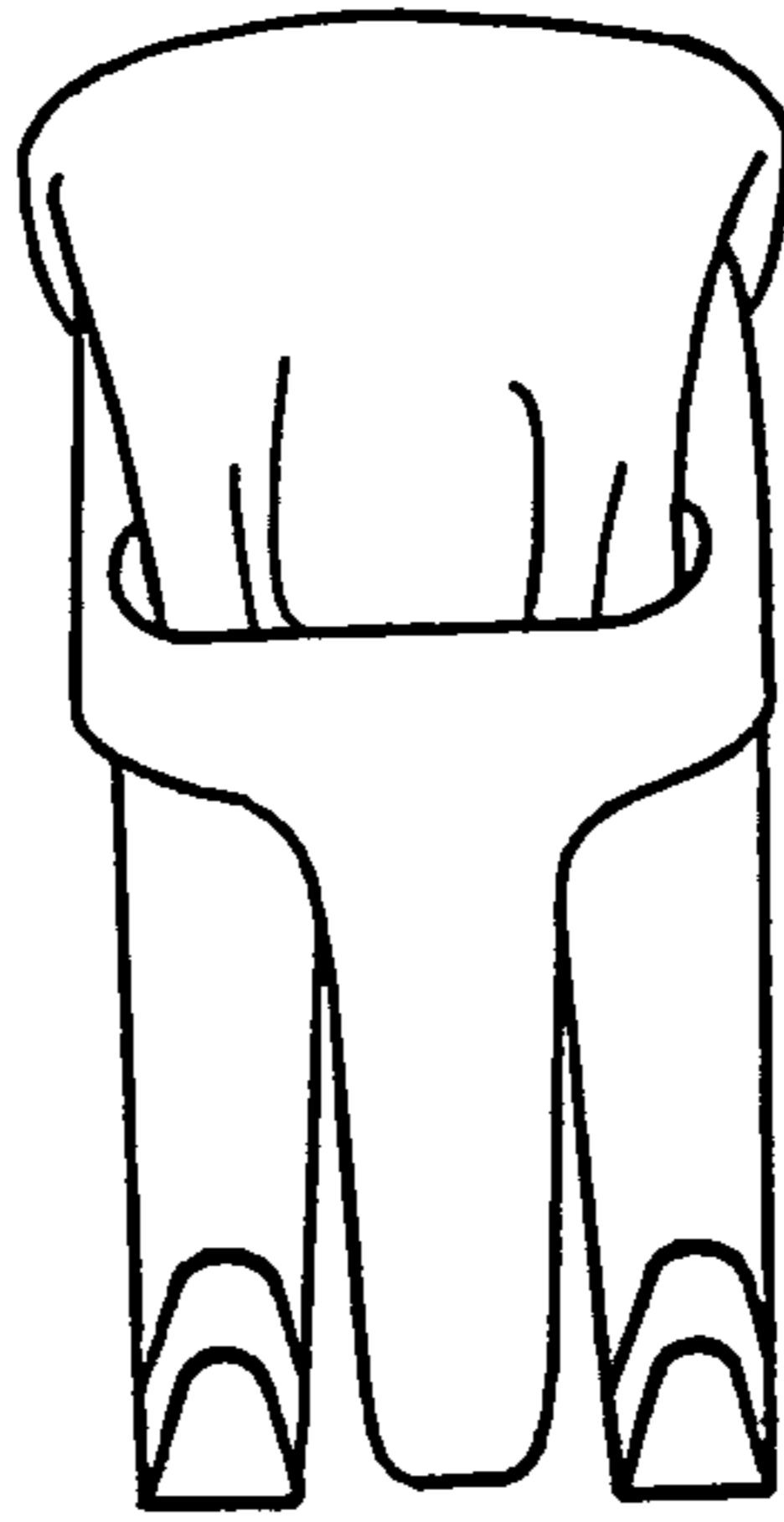

FIG 13

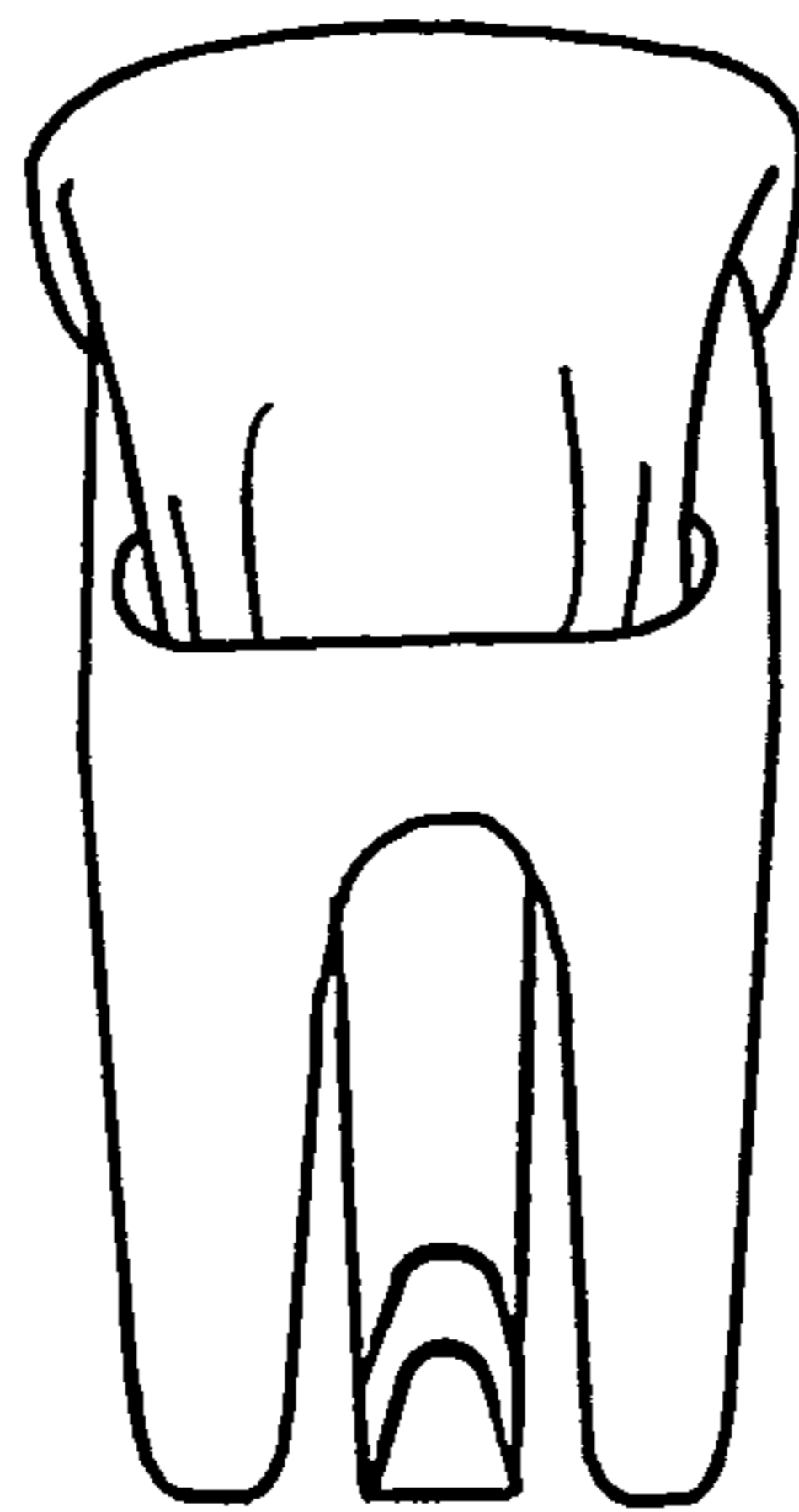

FIG 14

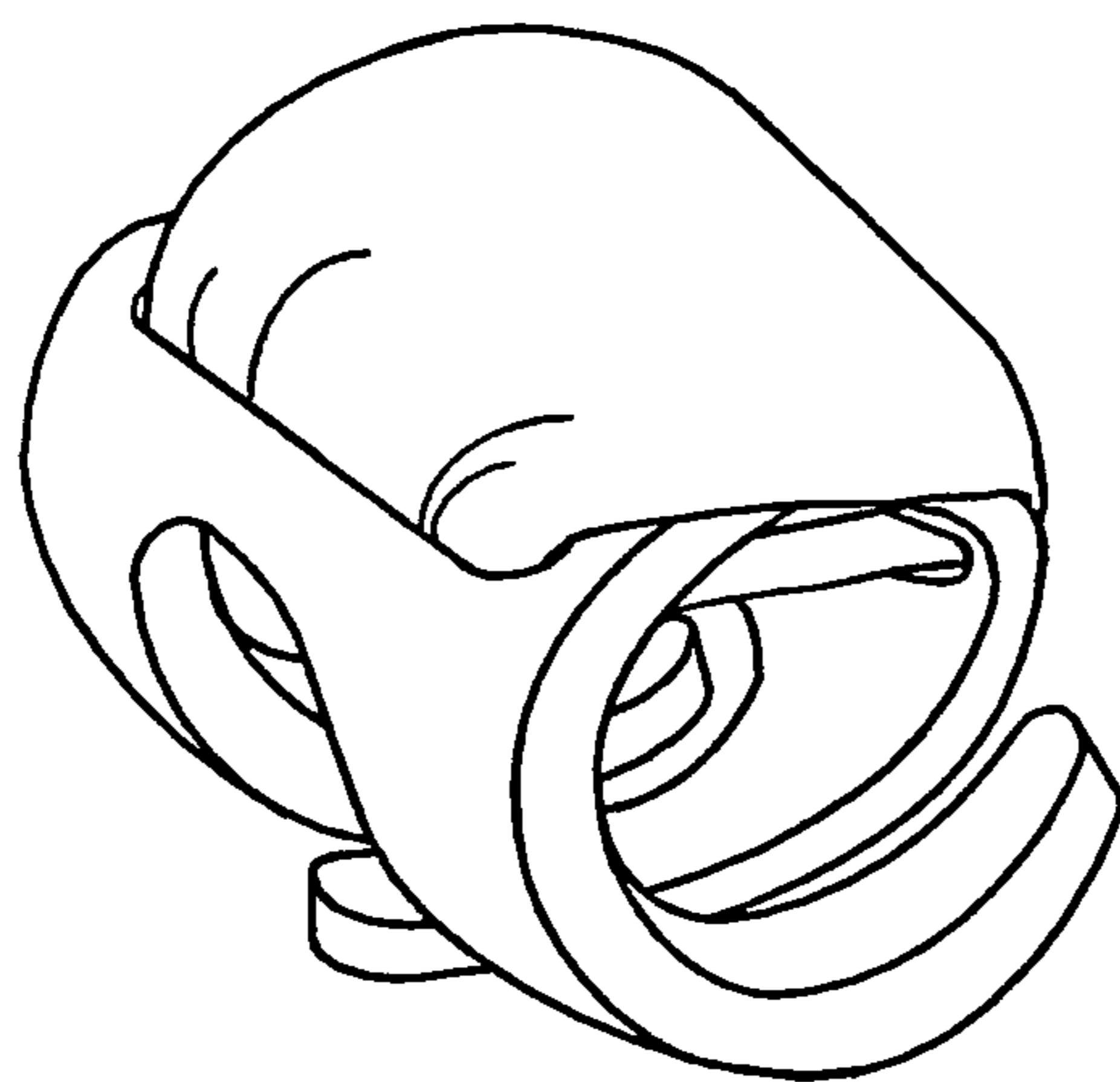

FIG 15

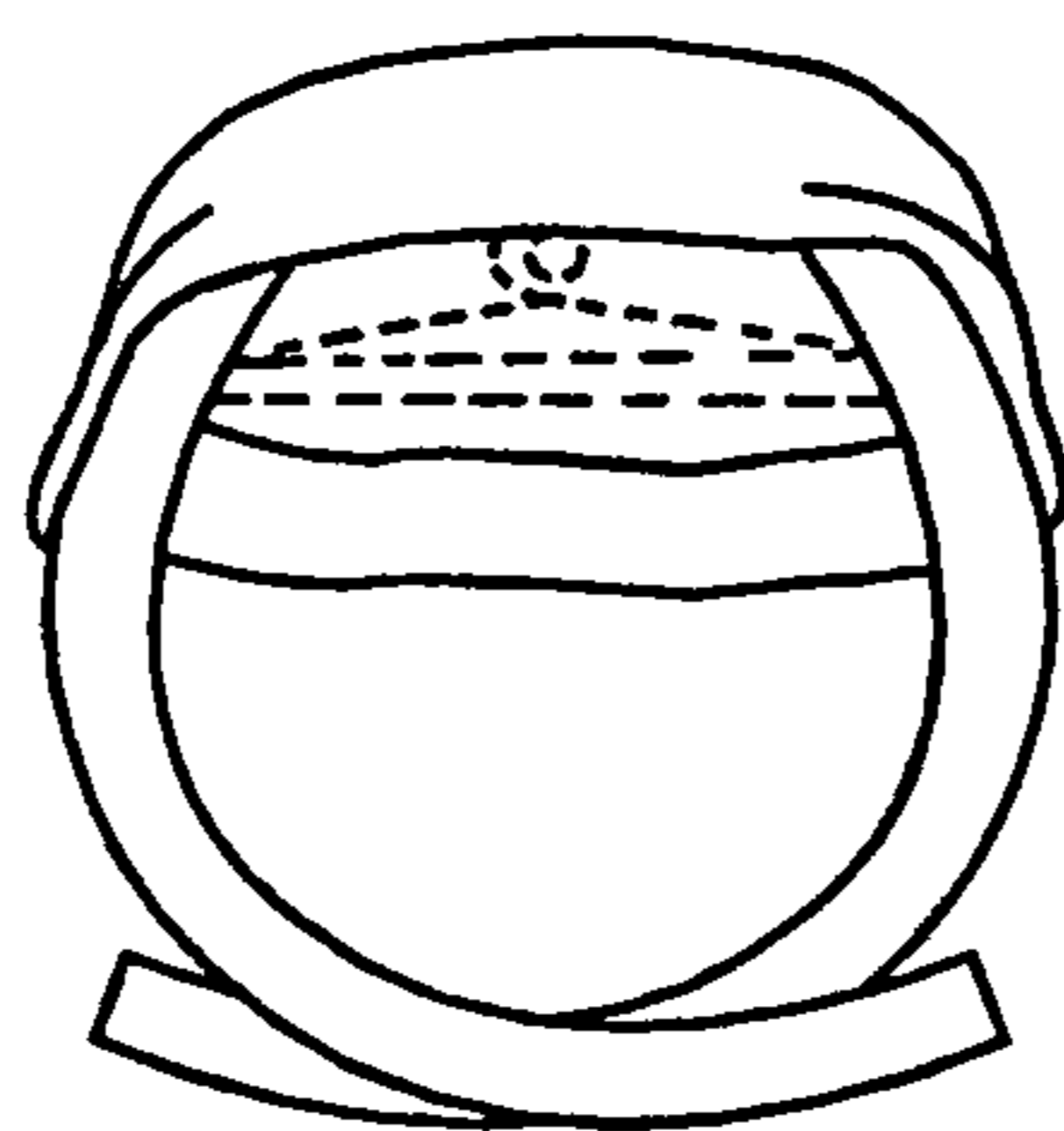

FIG 16

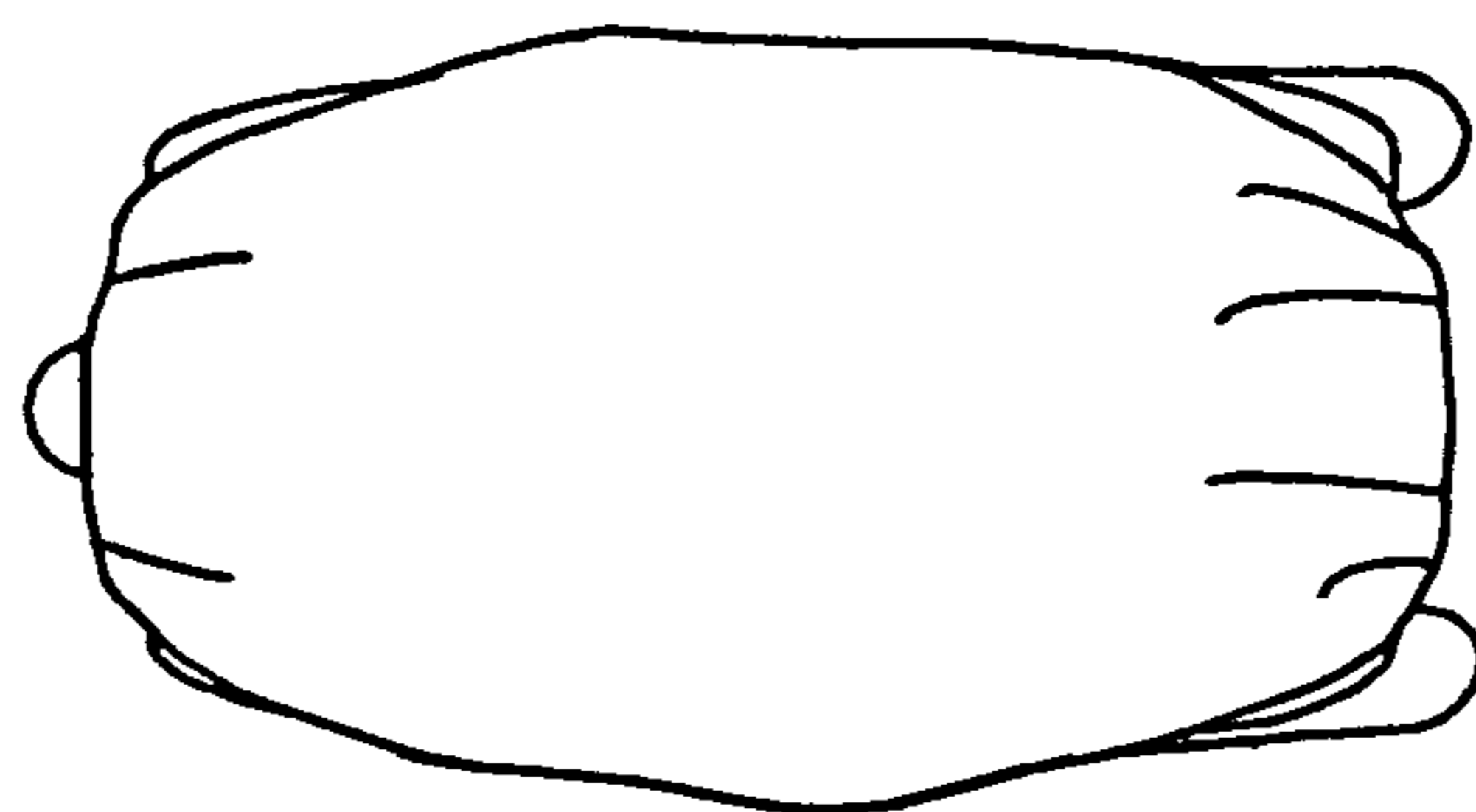

FIG 17

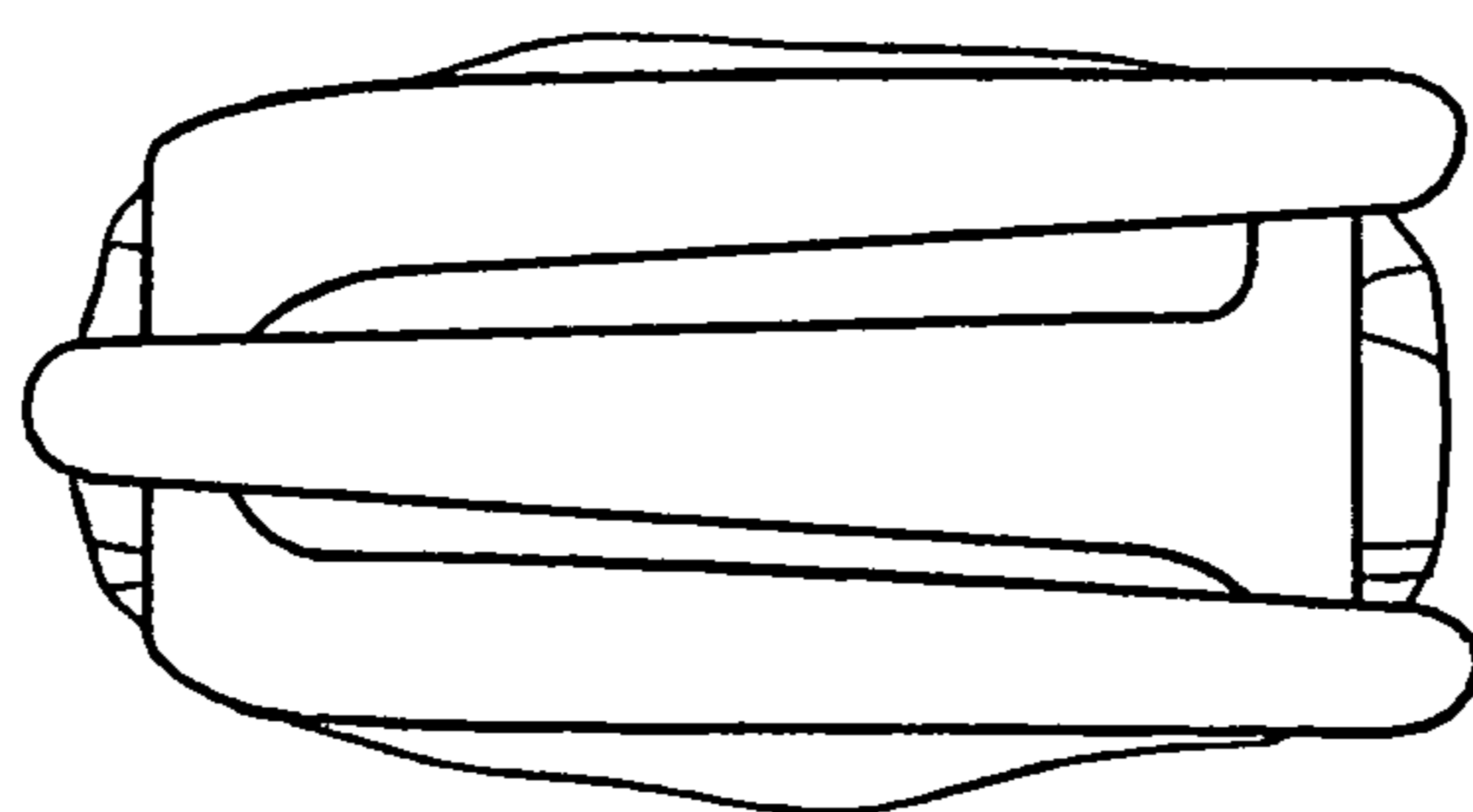

FIG 18