



US00D687183S

(12) **United States Design Patent**
Davis et al.

(10) **Patent No.:** **US D687,183 S**
(45) **Date of Patent:** **** Jul. 30, 2013**

(54) **TABLE FOR BEAUTY SALON USE**

FOREIGN PATENT DOCUMENTS

(75) Inventors: **William John Davis**, Corsham (GB);
Samuel William Lucking, Cheltenham
(GB); **David James McNeill**,
Chippenham (GB); **John Edward**
Sheppard, Wokingham (GB)

EP 000044748-0001 10/2003
EP 000044748-0002 10/2003

(Continued)

Primary Examiner — Jennifer Rivard

(74) *Attorney, Agent, or Firm* — James T. Fondriest

(73) Assignee: **The Procter & Gamble Company**,
Cincinnati, OH (US)

(**) Term: **14 Years**

(57) **CLAIM**

The ornamental design for a table for beauty salon use, as shown and described.

(21) Appl. No.: **29/397,767**

(22) Filed: **Jul. 20, 2011**

(51) **LOC (9) Cl.** **28-03**

(52) **U.S. Cl.**

USPC **D28/9**; D28/73

(58) **Field of Classification Search**

USPC D28/9, 10, 73; D6/449, 466–469,
D6/474, 475, 476, 482, 483, 486, 678, 678.1,
D6/657, 662.1, 663, 669; 211/128.1–130.1,
211/133.1–133.3

See application file for complete search history.

DESCRIPTION

FIG. 1 is a perspective view of a table embodying our new design;

FIG. 2 is a front view of the table shown in FIG. 1;

FIG. 3 is a back view of the table shown in FIG. 1;

FIG. 4 is a left side view of the table shown in FIG. 1;

FIG. 5 is a right side view of the table shown in FIG. 1;

FIG. 6 is a top view of the table shown in FIG. 1.

FIG. 7 is a bottom view of the table shown in FIG. 1.

FIG. 8 is a perspective view of a second embodiment of a table embodying our new design;

FIG. 9 is a front view of the table shown in FIG. 8;

FIG. 10 is a back view of the table shown in FIG. 8;

FIG. 11 is a left side view of the table shown in FIG. 8;

FIG. 12 is a right side view of the table shown in FIG. 8;

FIG. 13 is a top view of the table shown in FIG. 8; and,

FIG. 14 is a bottom view of the table shown in FIG. 8.

The broken lines shown in the drawings illustrate portions of the table and form no part of the claimed design.

(56) **References Cited**

U.S. PATENT DOCUMENTS

4,548,324	A *	10/1985	Mackey, Jr.	211/58
4,792,470	A *	12/1988	Clark	428/12
D346,083	S *	4/1994	Bareiss	D6/495
D383,568	S *	9/1997	Giedd	D28/73
D391,097	S *	2/1998	Eichert et al.	D6/449
D395,182	S *	6/1998	Singleton	D6/469
5,819,960	A *	10/1998	Bonazza	211/133.1
D449,712	S *	10/2001	Glemain	D28/73
D502,786	S *	3/2005	Cheung	D28/73

(Continued)

1 Claim, 12 Drawing Sheets

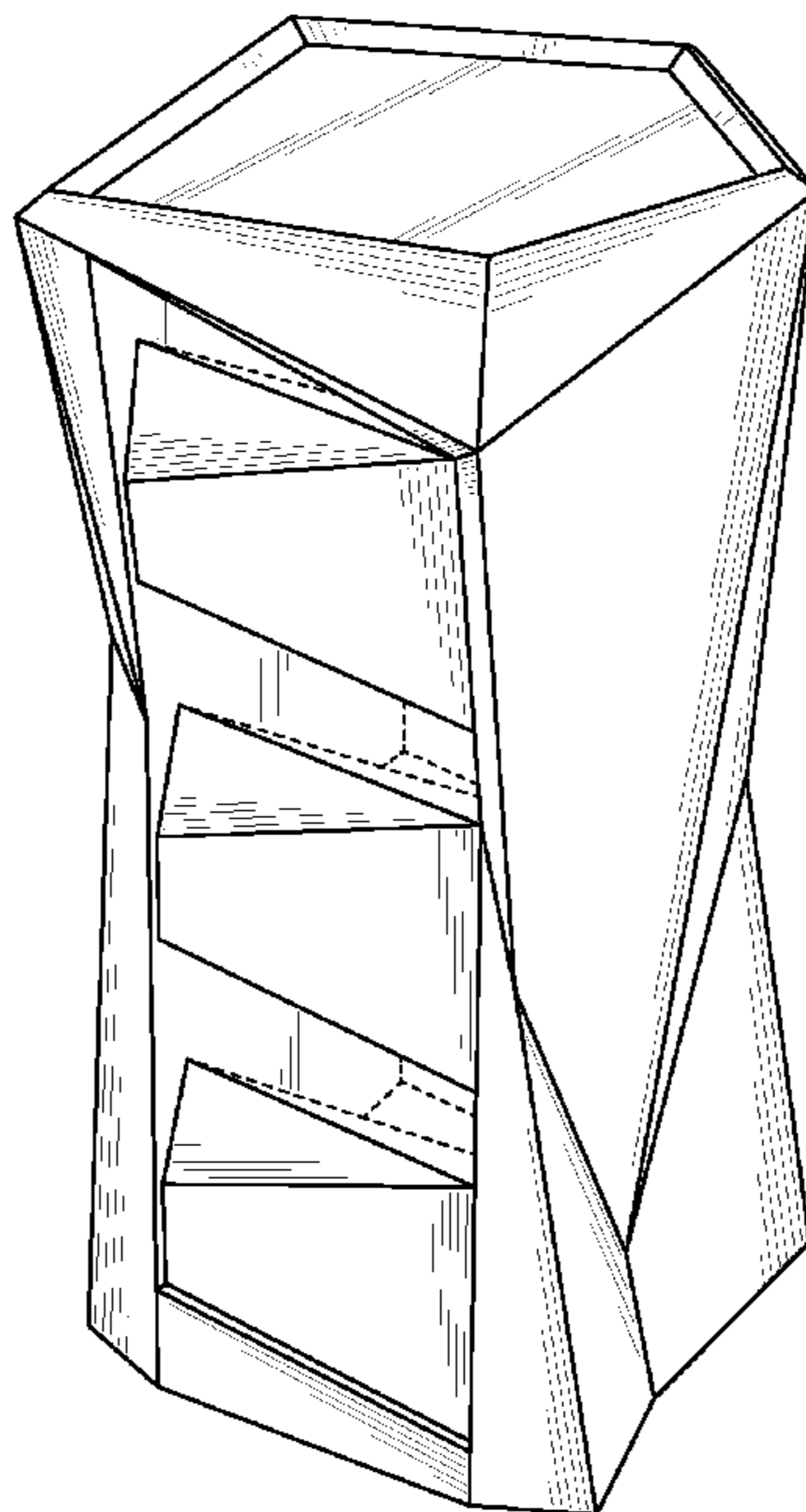

US D687,183 S

Page 2

U.S. PATENT DOCUMENTS

D511,912 S * 11/2005 Blonder D6/486
7,159,728 B2 * 1/2007 Smith 211/166
D538,997 S 3/2007 Schlembach
D605,353 S * 12/2009 Lee et al. D28/9
D630,799 S * 1/2011 Greiner D28/73
D642,741 S * 8/2011 Greiner D28/73
D644,039 S * 8/2011 Naples et al. D6/449
D647,726 S * 11/2011 Strauch D6/449

FOREIGN PATENT DOCUMENTS

EP 000334081-0001 7/2005

EP 000334081-0002 7/2005
EP 001505553-0001 6/2009
EP 001505553-0002 6/2009
EP 001505553-0003 6/2009
ES D0500996-02 6/2005
GB 2060843 3/1997
GB 2073898 8/1998
GB 2086666 12/1999
GB 3022892 11/2005
WO D037902-001 12/1996
WO D038500-001 2/1997

* cited by examiner

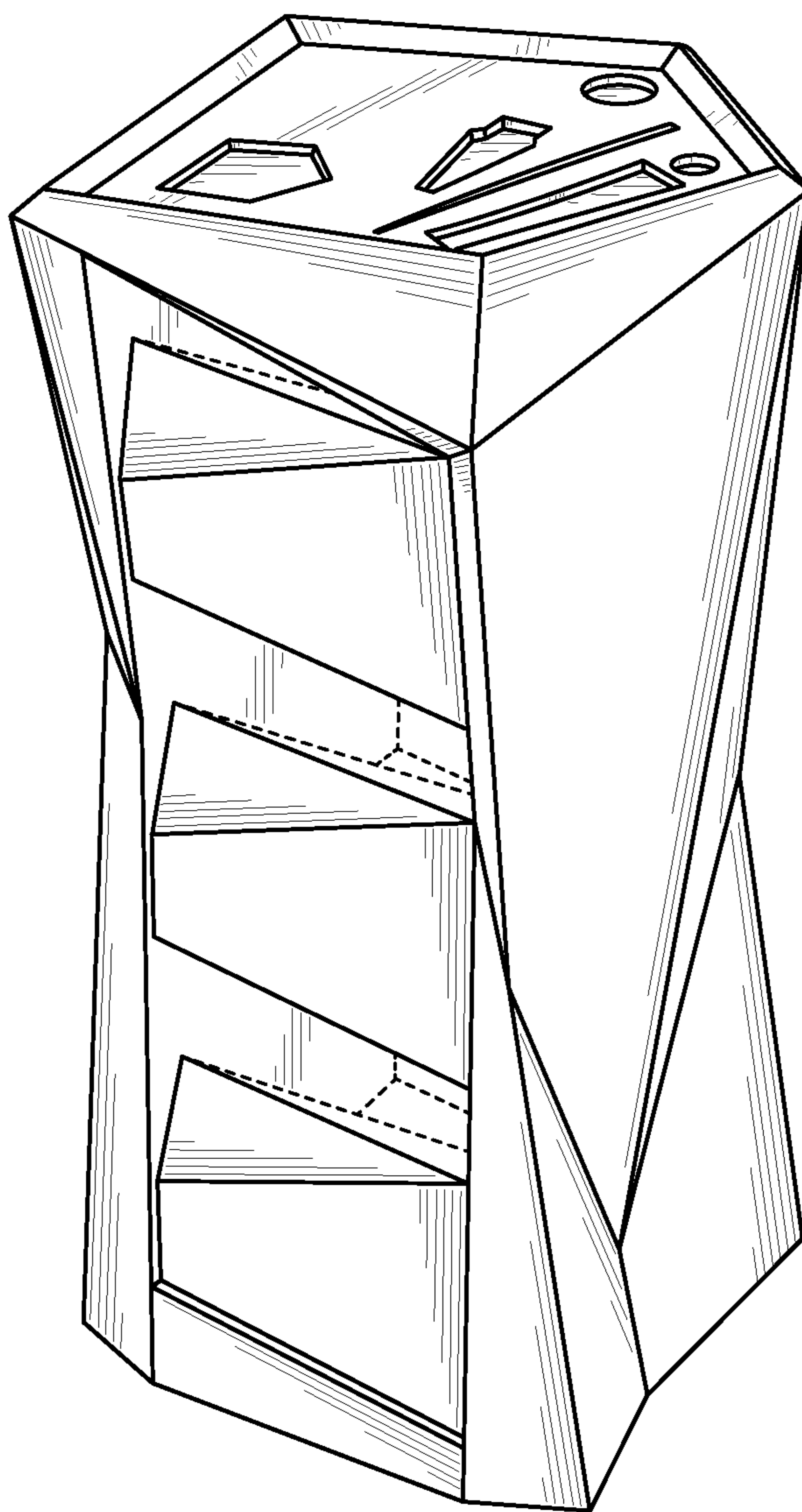

Fig. 1

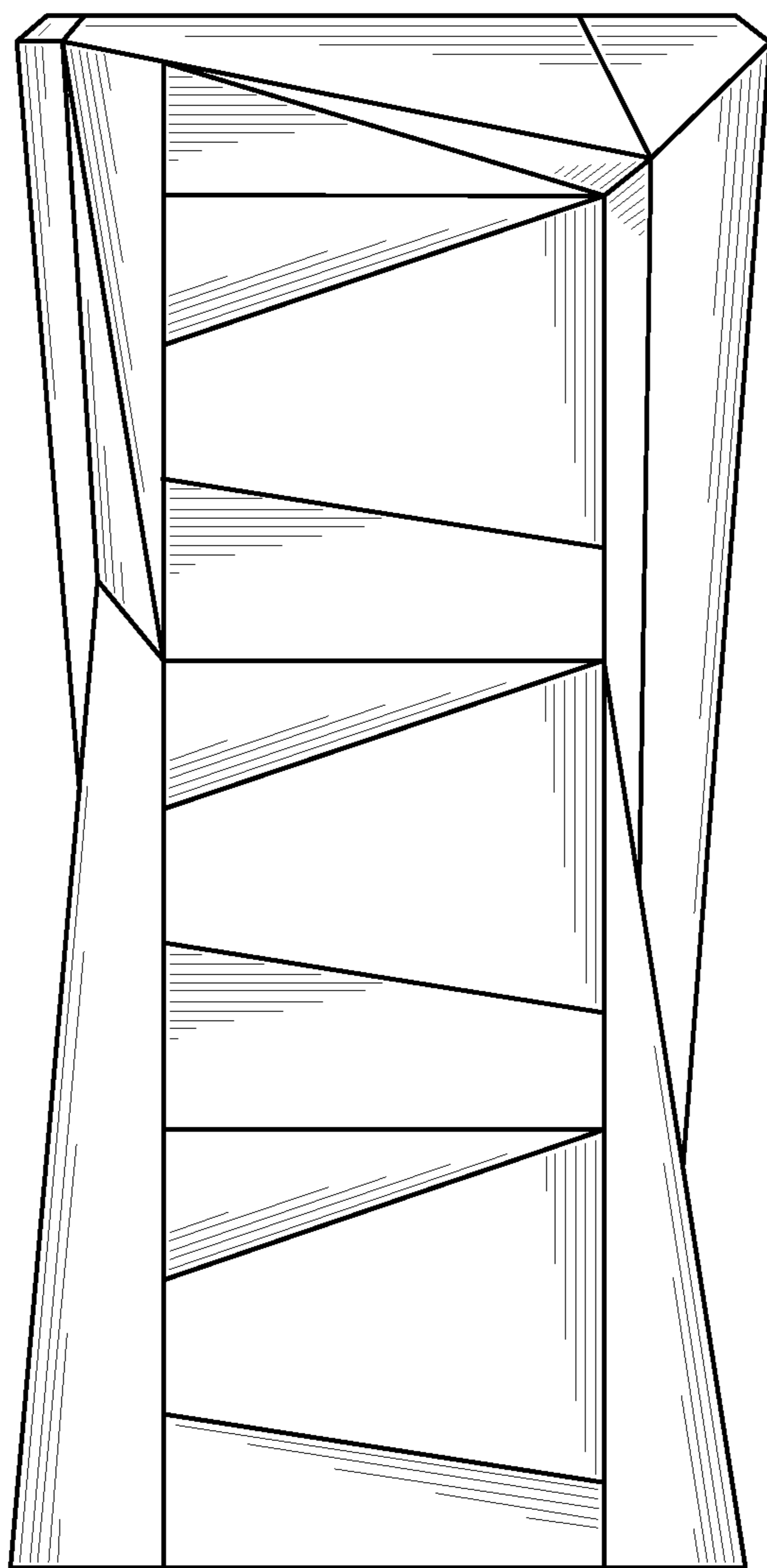

Fig. 2

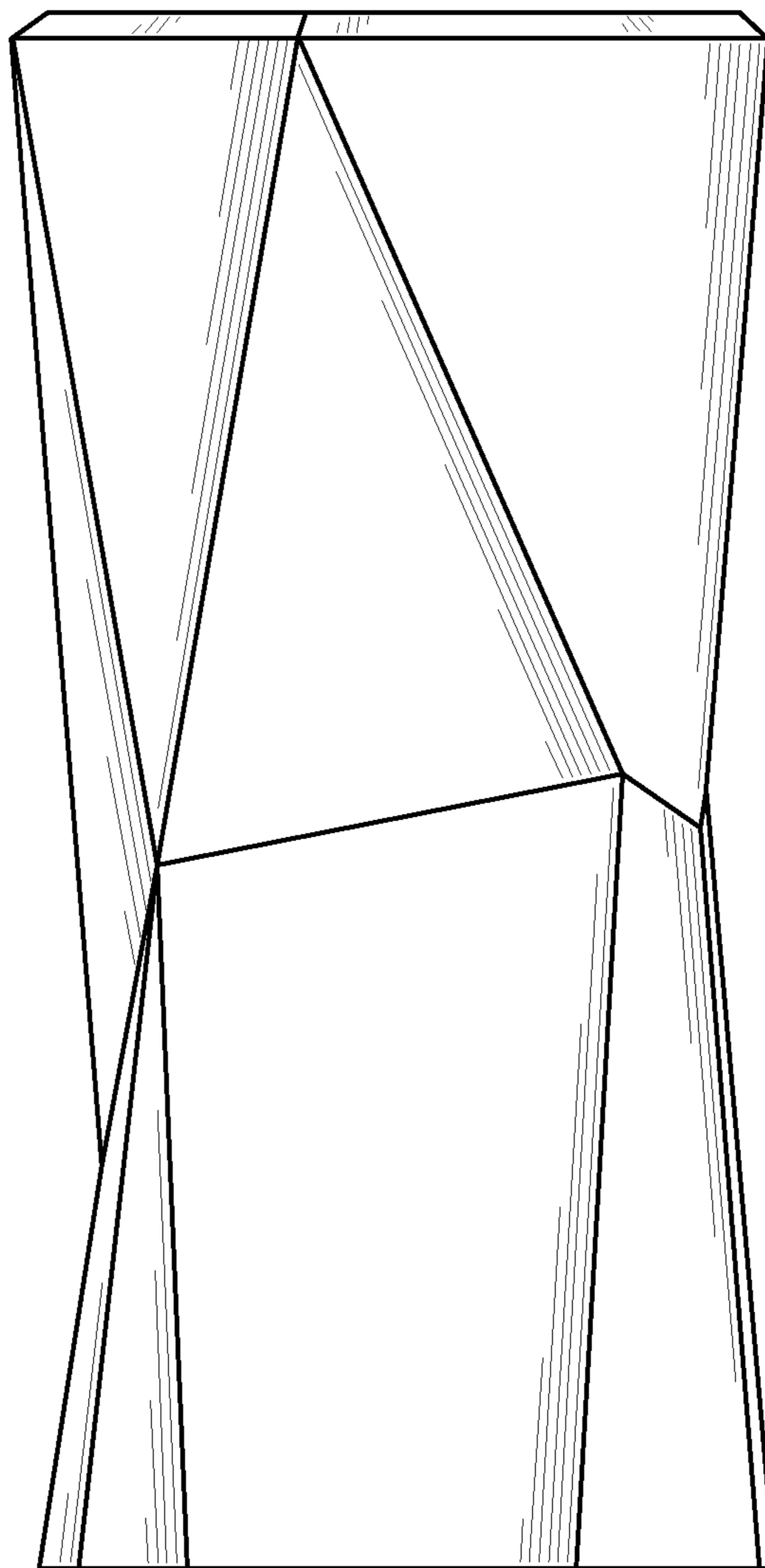

Fig. 3

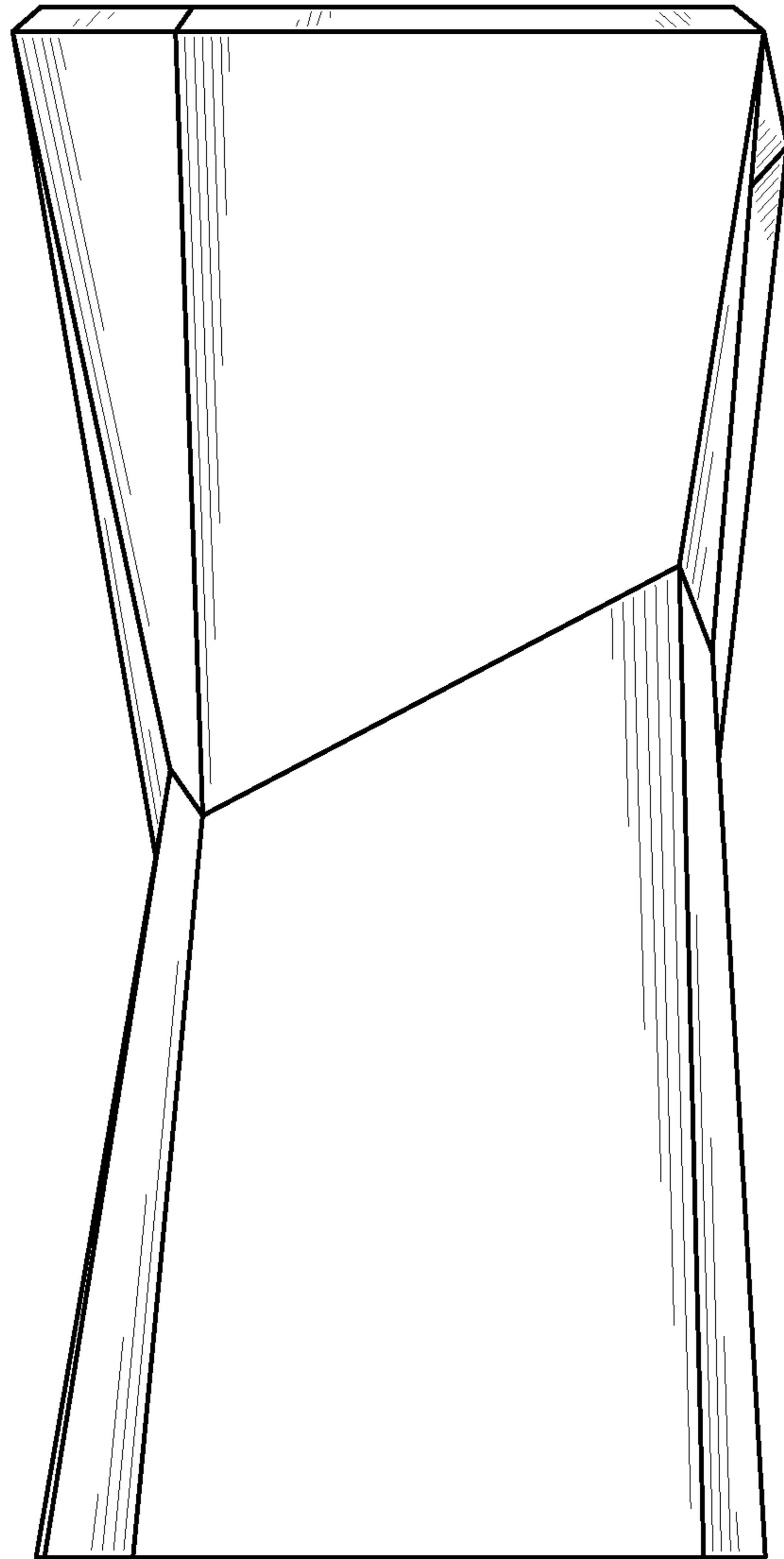

Fig. 4

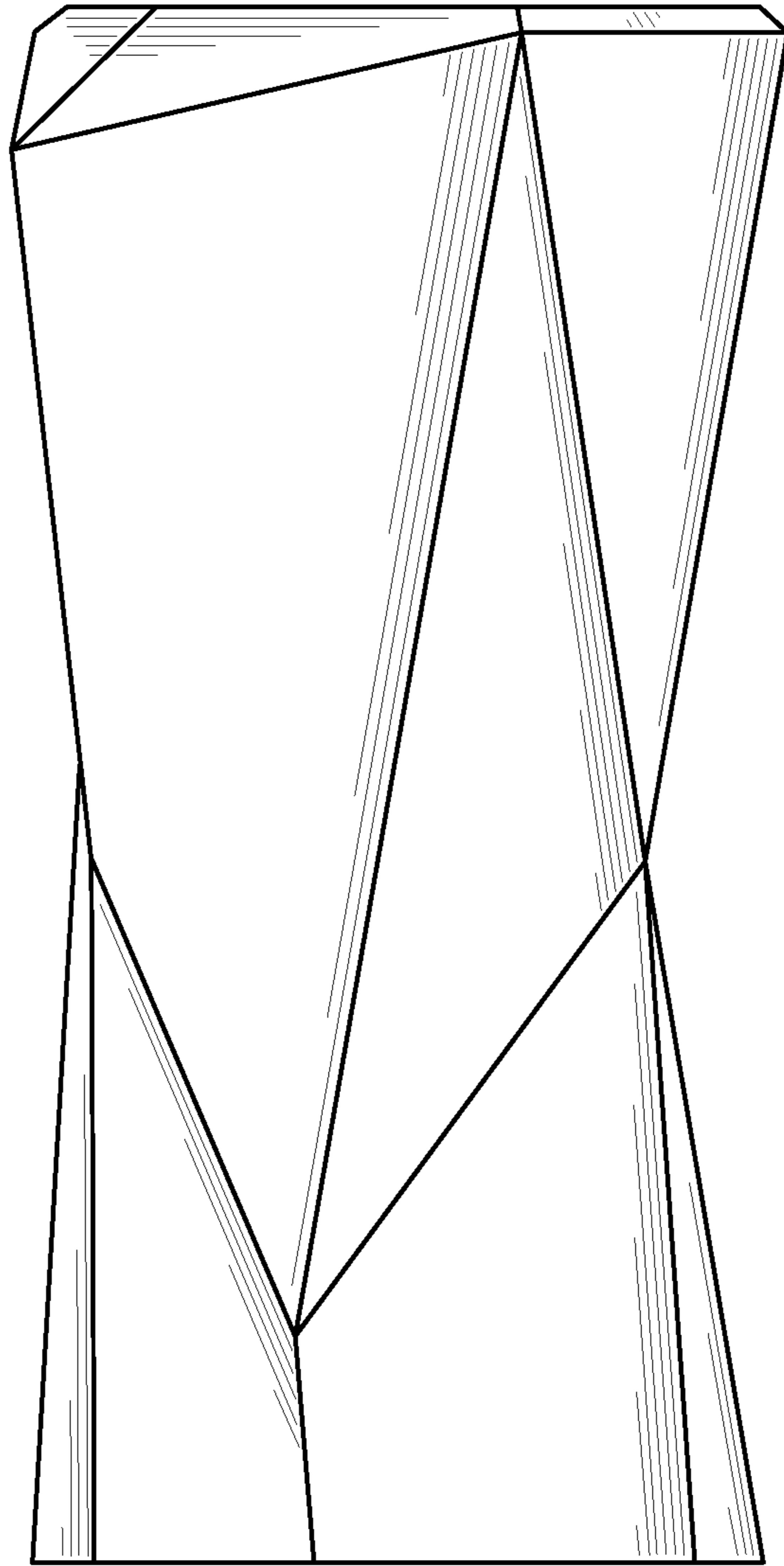

Fig. 5

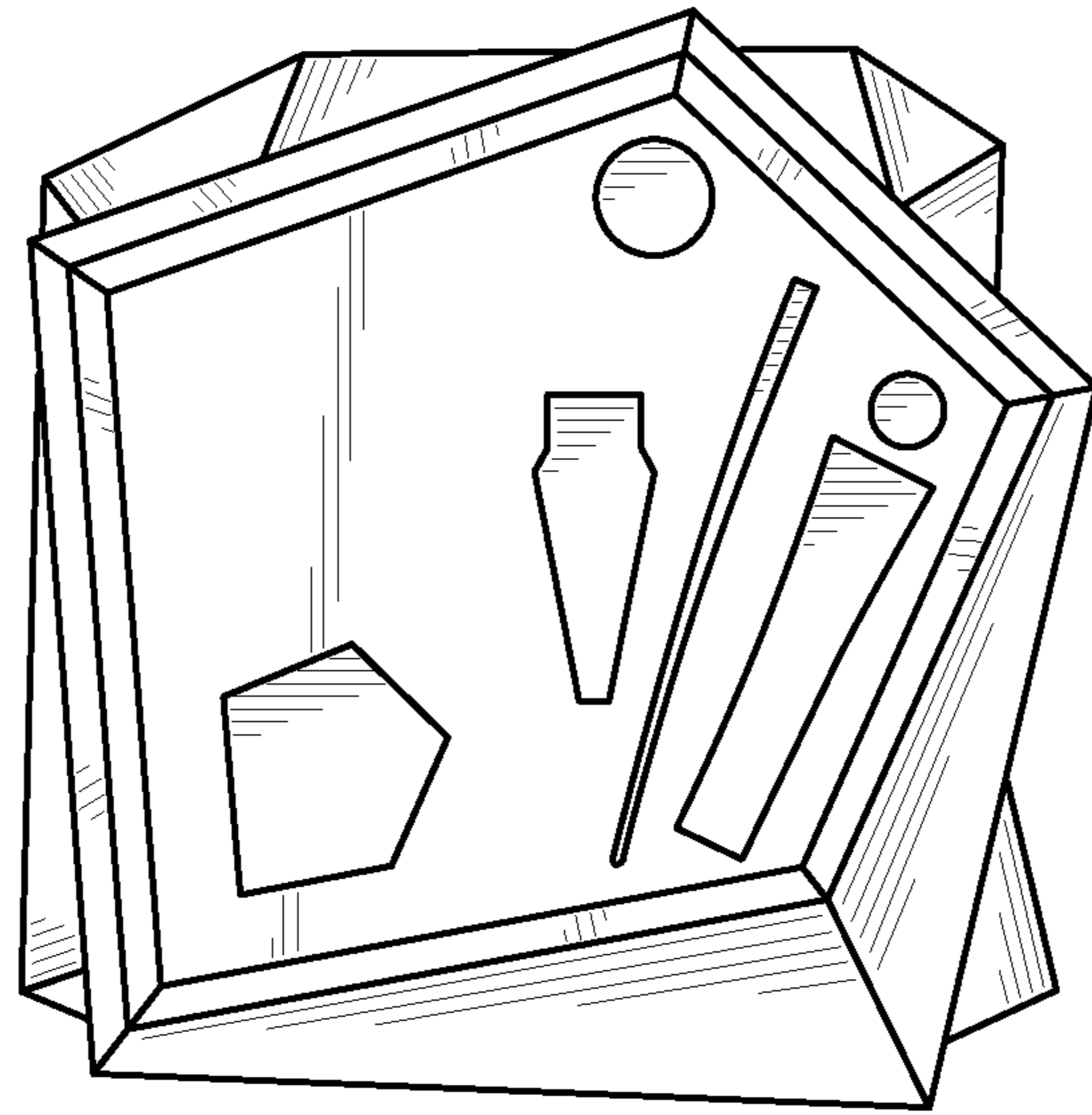

Fig. 6

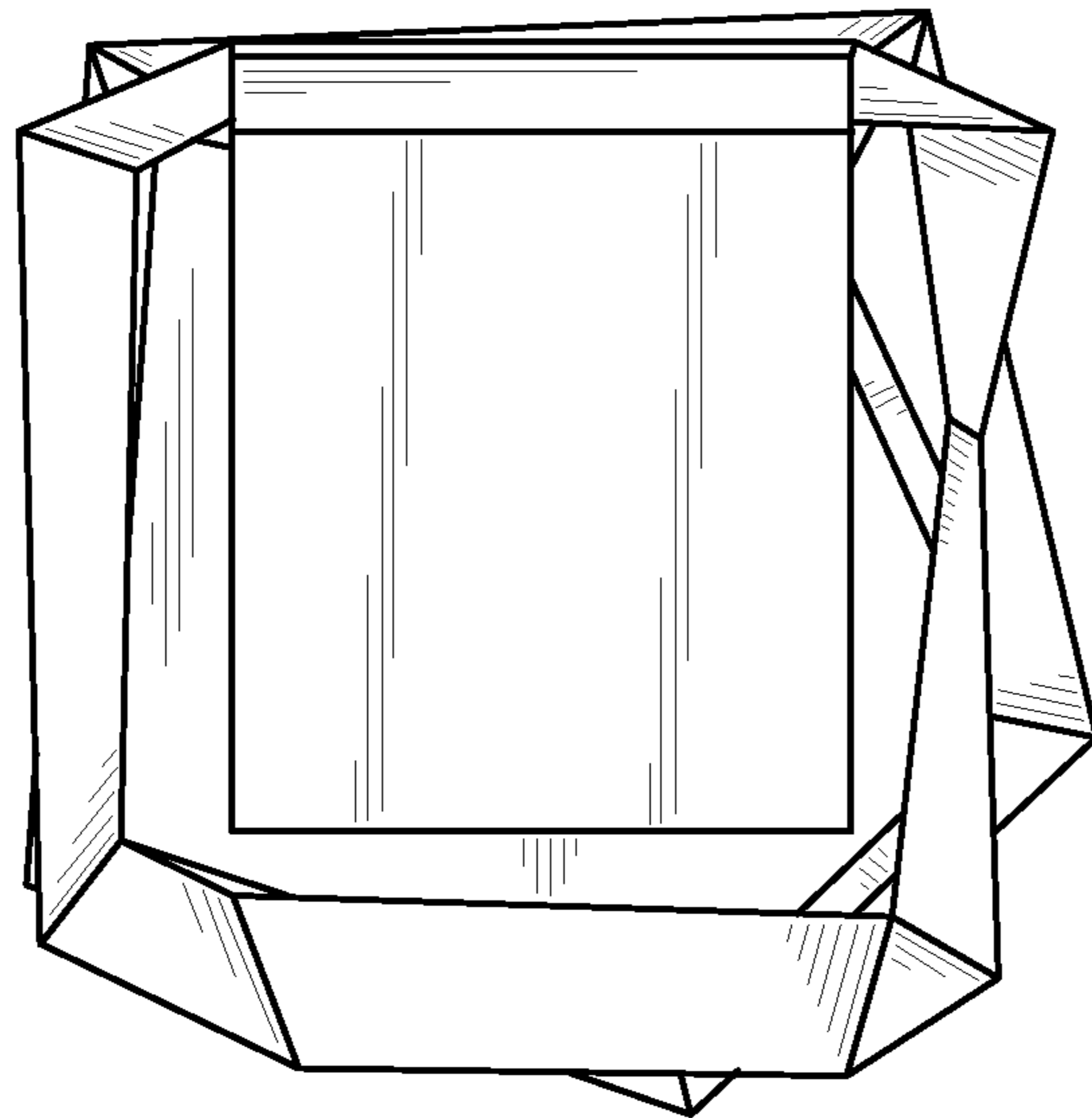

Fig. 7

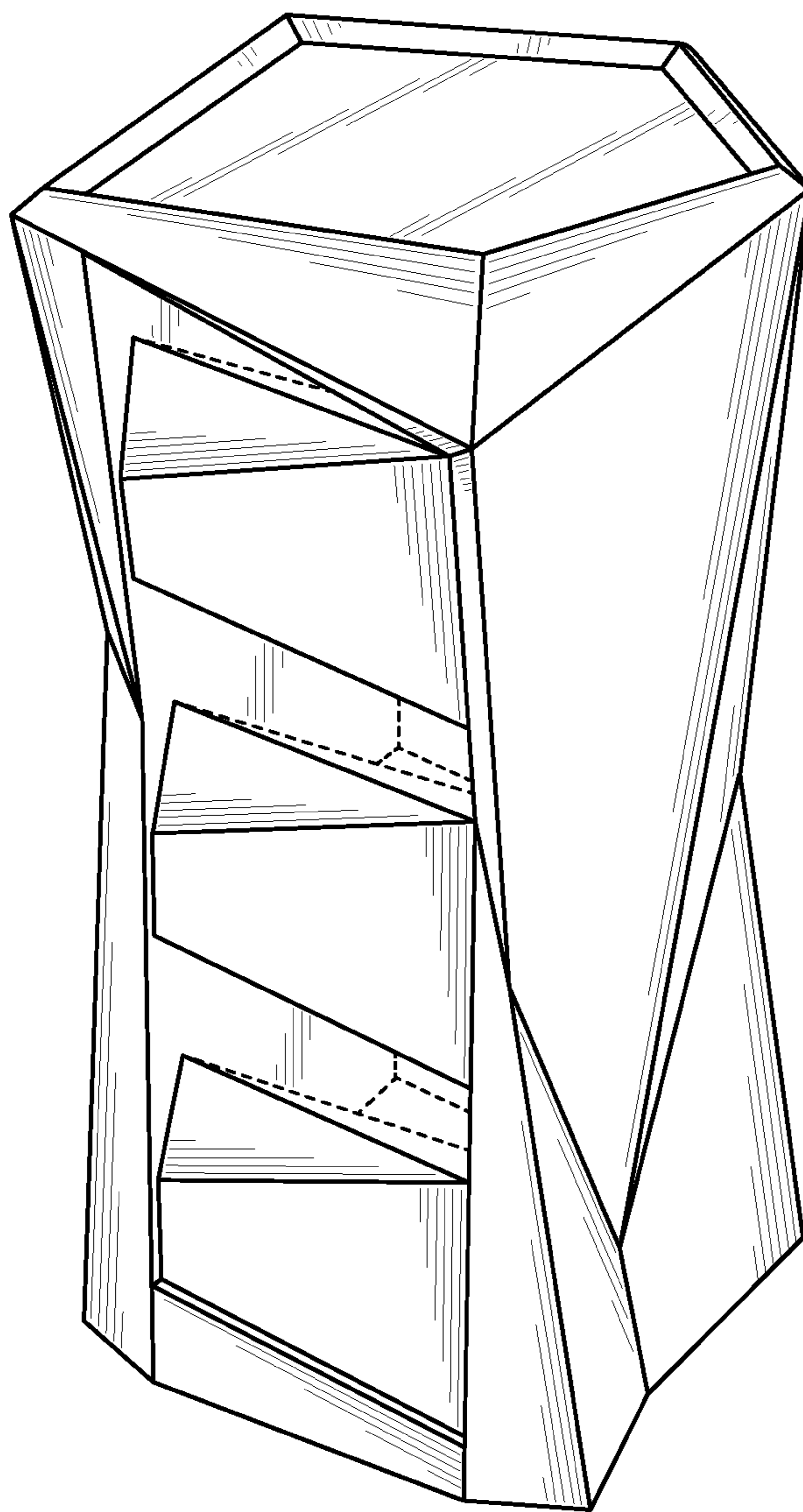

Fig. 8

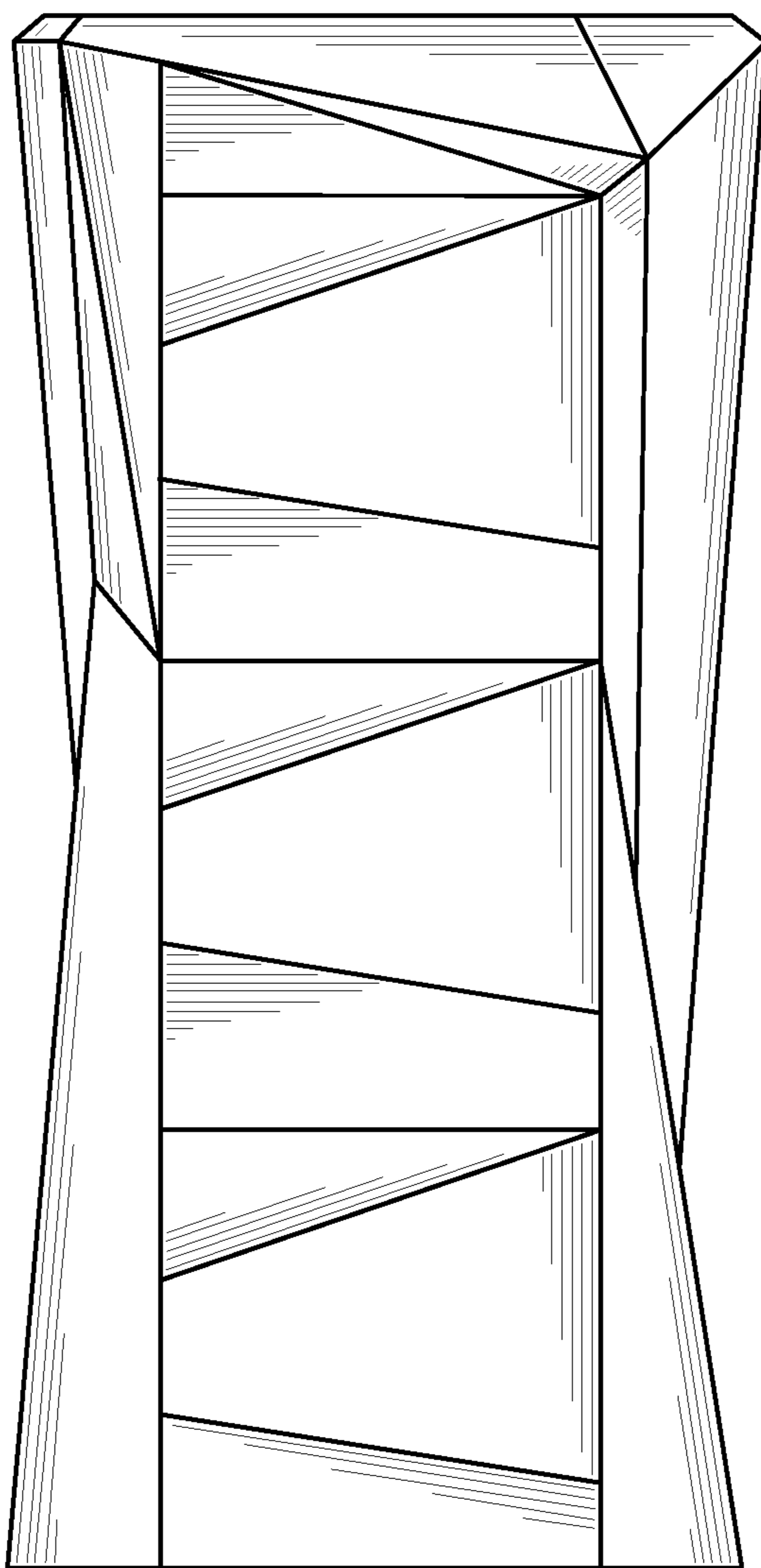

Fig. 9

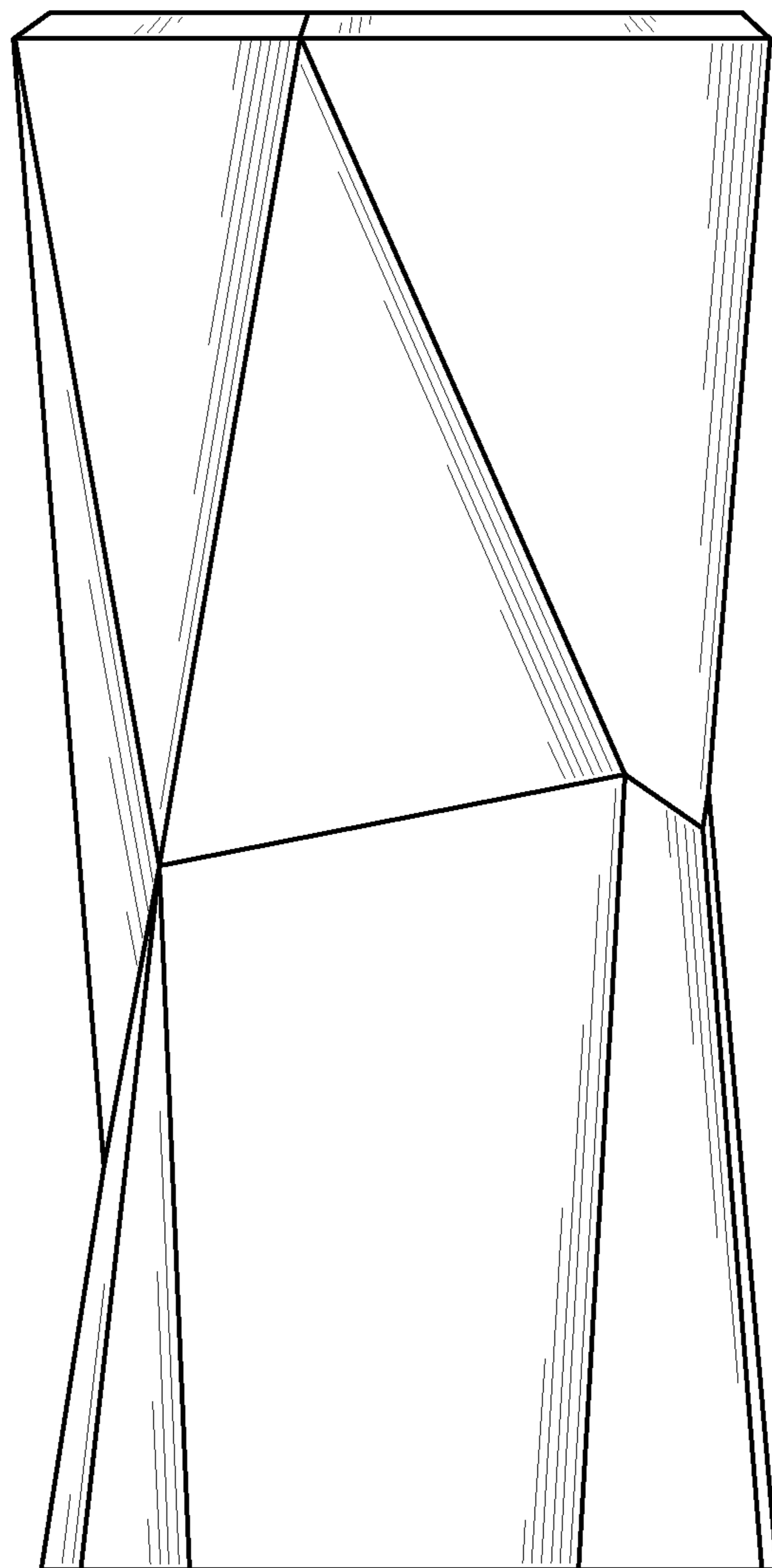

Fig. 10

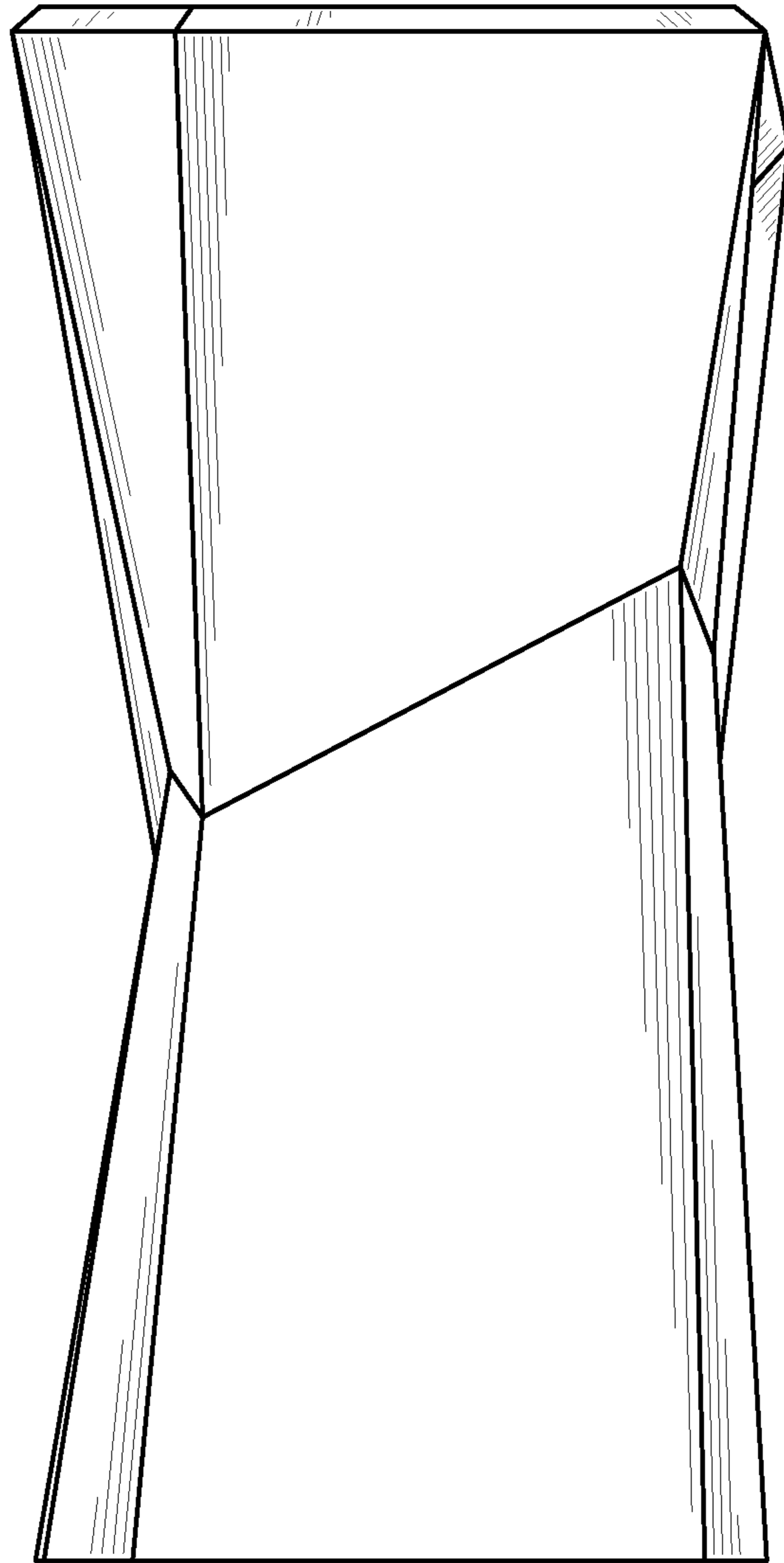

Fig. 11

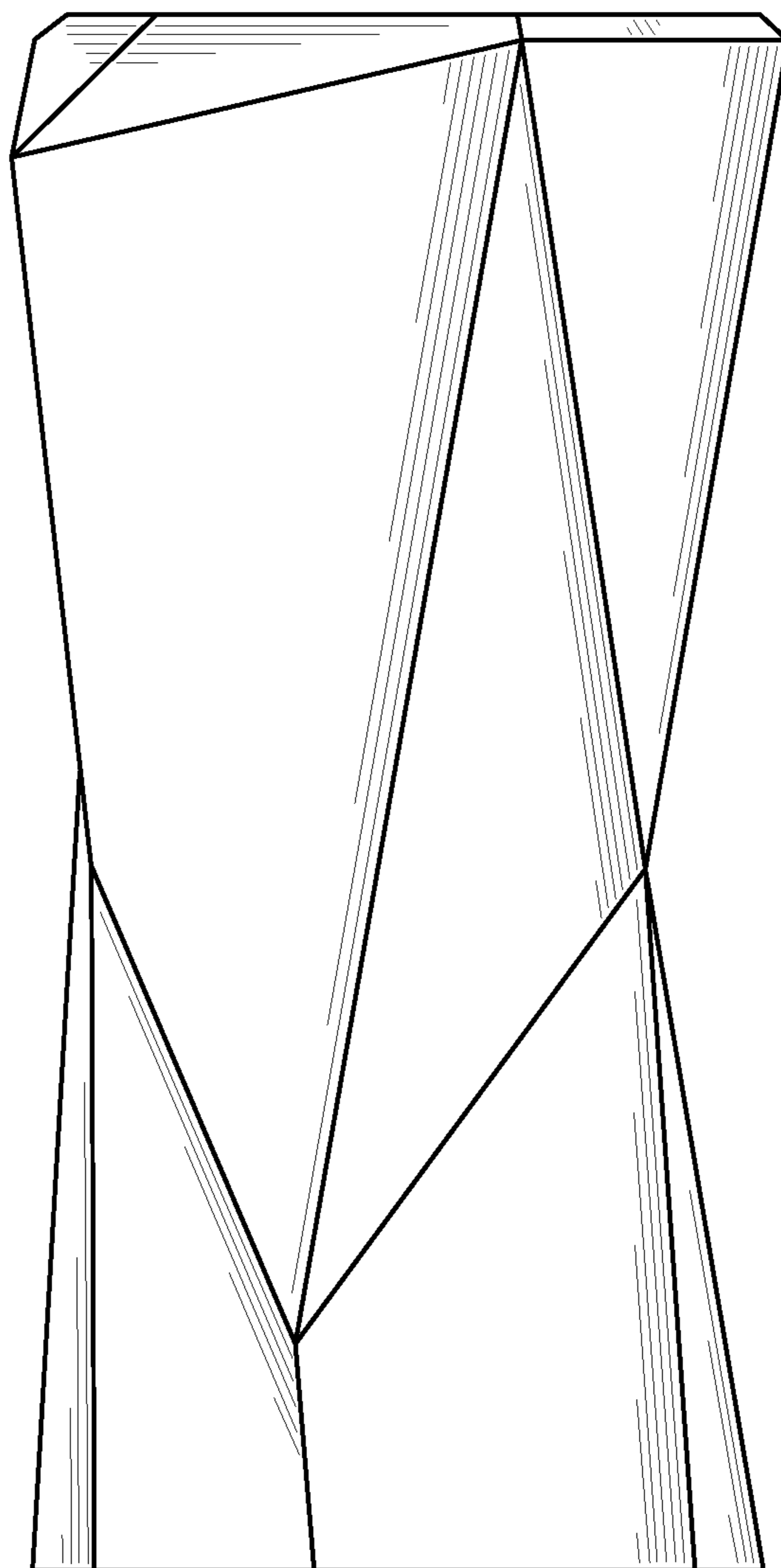

Fig. 12

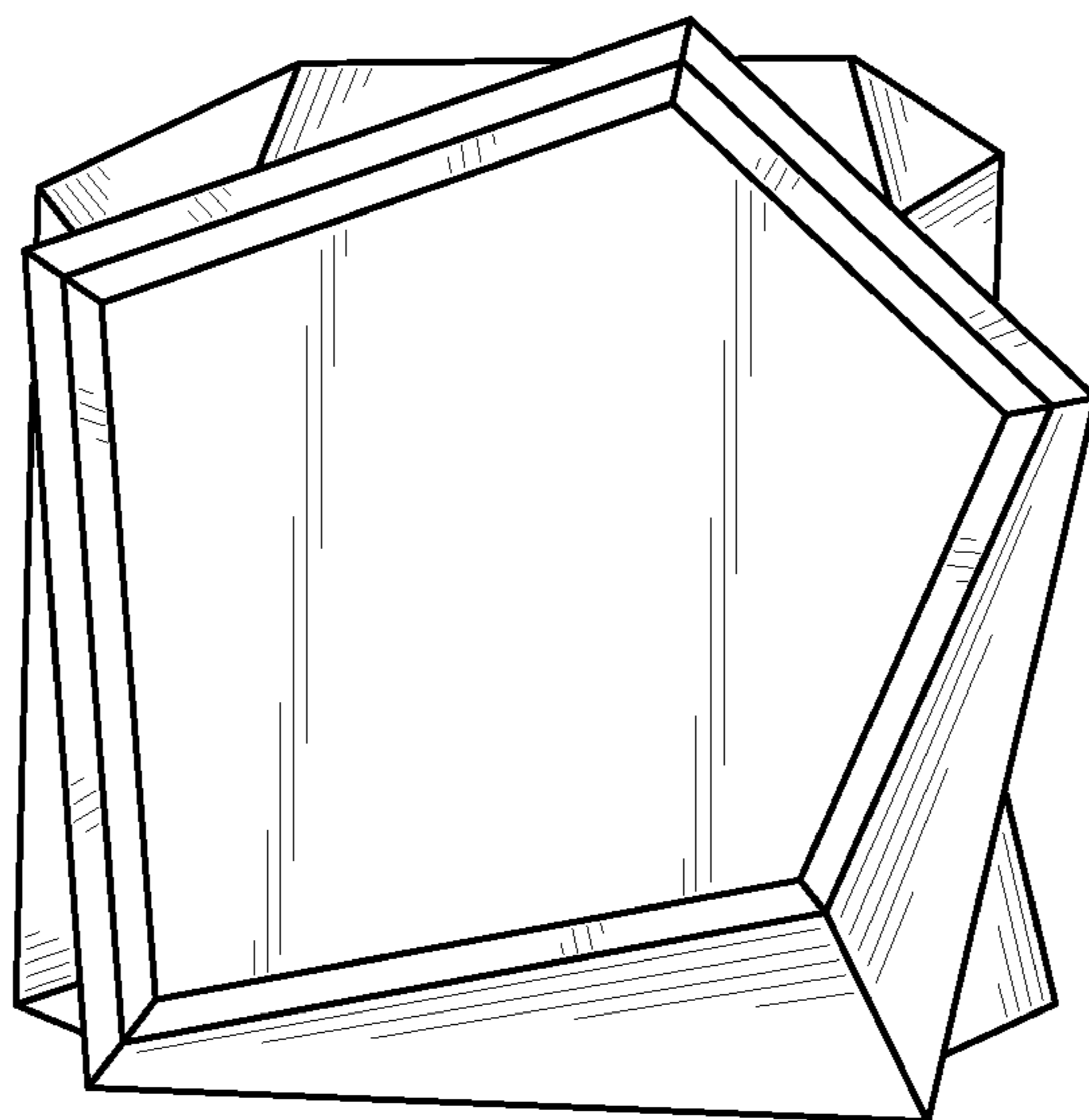

Fig. 13

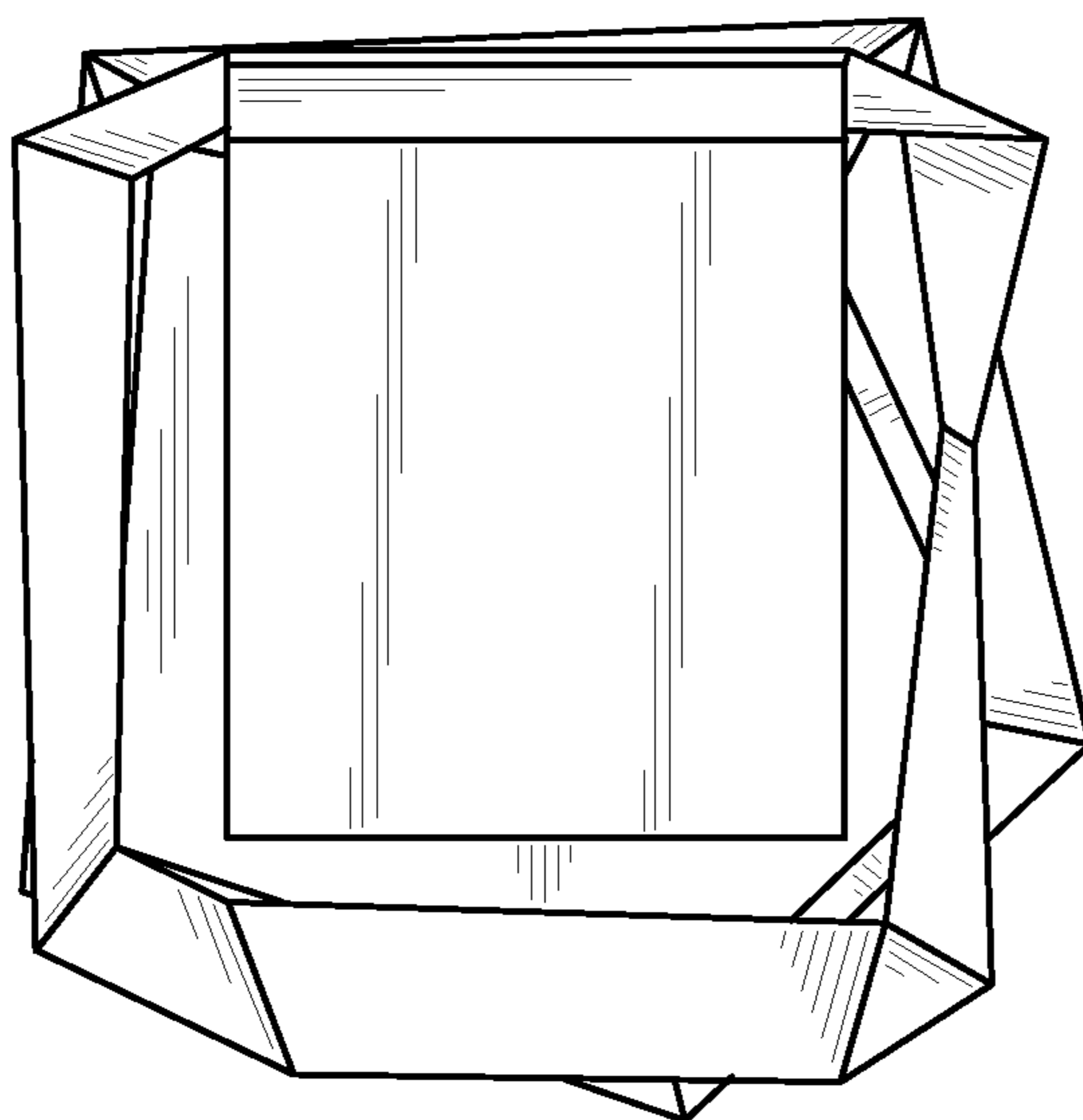

Fig. 14