



US00D687163S

(12) **United States Design Patent**  
**Paxton et al.**

(10) **Patent No.:** **US D687,163 S**  
(45) **Date of Patent:** **\*\* Jul. 30, 2013**

(54) **DOOR FACING**

*Primary Examiner* — Doris Clark

(75) Inventors: **David Paxton**, Doncaster (GB); **Jon Walker**, Heckmondwike (GB)

(74) *Attorney, Agent, or Firm* — Berenato & White, LLC

(73) Assignee: **Masonite Corporation**, Tampa, FL (US)

(57) **CLAIM**

(\*\*) Term: **14 Years**

The ornamental design for a door facing, as shown and described.

(21) Appl. No.: **29/412,376**

(22) Filed: **Feb. 2, 2012**

**DESCRIPTION**

(51) **LOC (9) Cl.** ..... **25-02**

(52) **U.S. Cl.**  
USPC ..... **D25/48.3**

(58) **Field of Classification Search**  
USPC ..... D25/48.3; 52/455; 49/504  
See application file for complete search history.

FIG. 1 is a front perspective view of our design;  
FIG. 2 is a front elevational view;  
FIG. 3 is a rear elevational view;  
FIG. 4 is a top plan view;  
FIG. 5 is a bottom plan view;  
FIG. 6 is a cross-sectional view taken along the line 6-6 of FIG. 2;  
FIG. 7 is an exploded fragmentary view of FIG. 6;  
FIG. 8 is a left side elevational view;  
FIG. 9 is a right side elevational view; and,  
FIG. 10 is a cross-sectional view elevational view taken along the line 10-10 of FIG. 2.

(56) **References Cited**

**U.S. PATENT DOCUMENTS**

1,183,842	A	*	5/1916	Alling	.....	52/455
D529,625	S	*	10/2006	Walsh et al.	.....	D25/48.3
D600,819	S	*	9/2009	Walsh et al.	.....	D25/48.3

\* cited by examiner

**1 Claim, 5 Drawing Sheets**

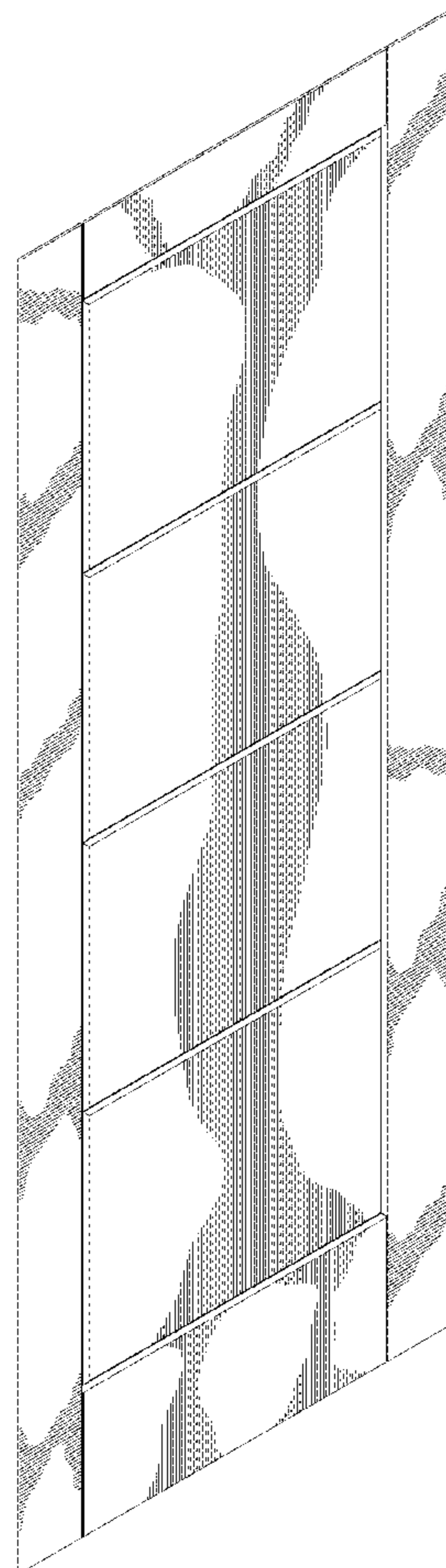

Fig. 1

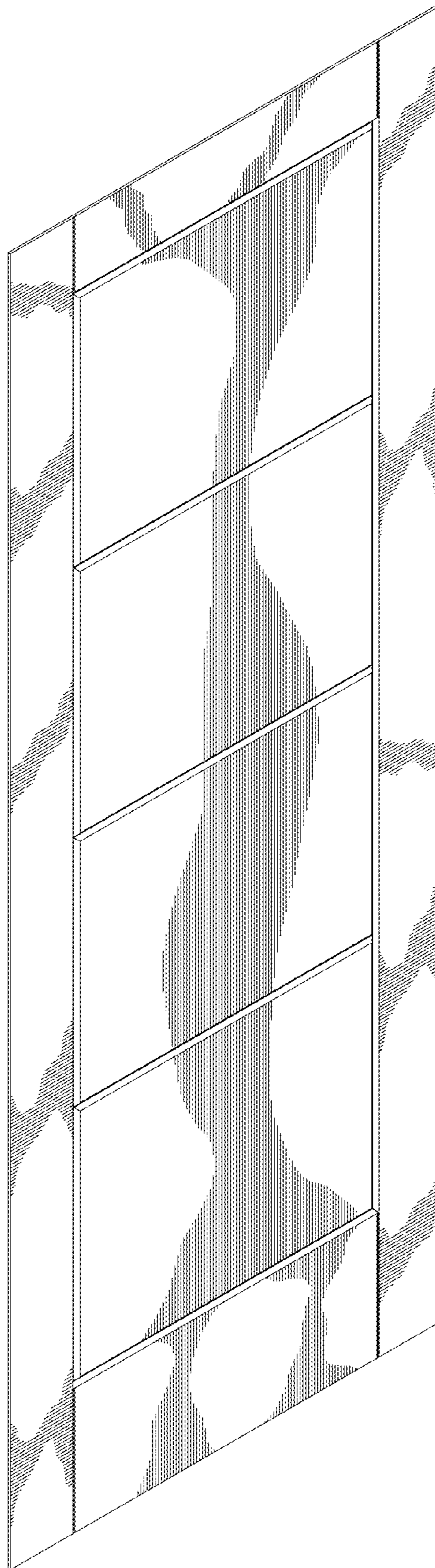

Fig. 2

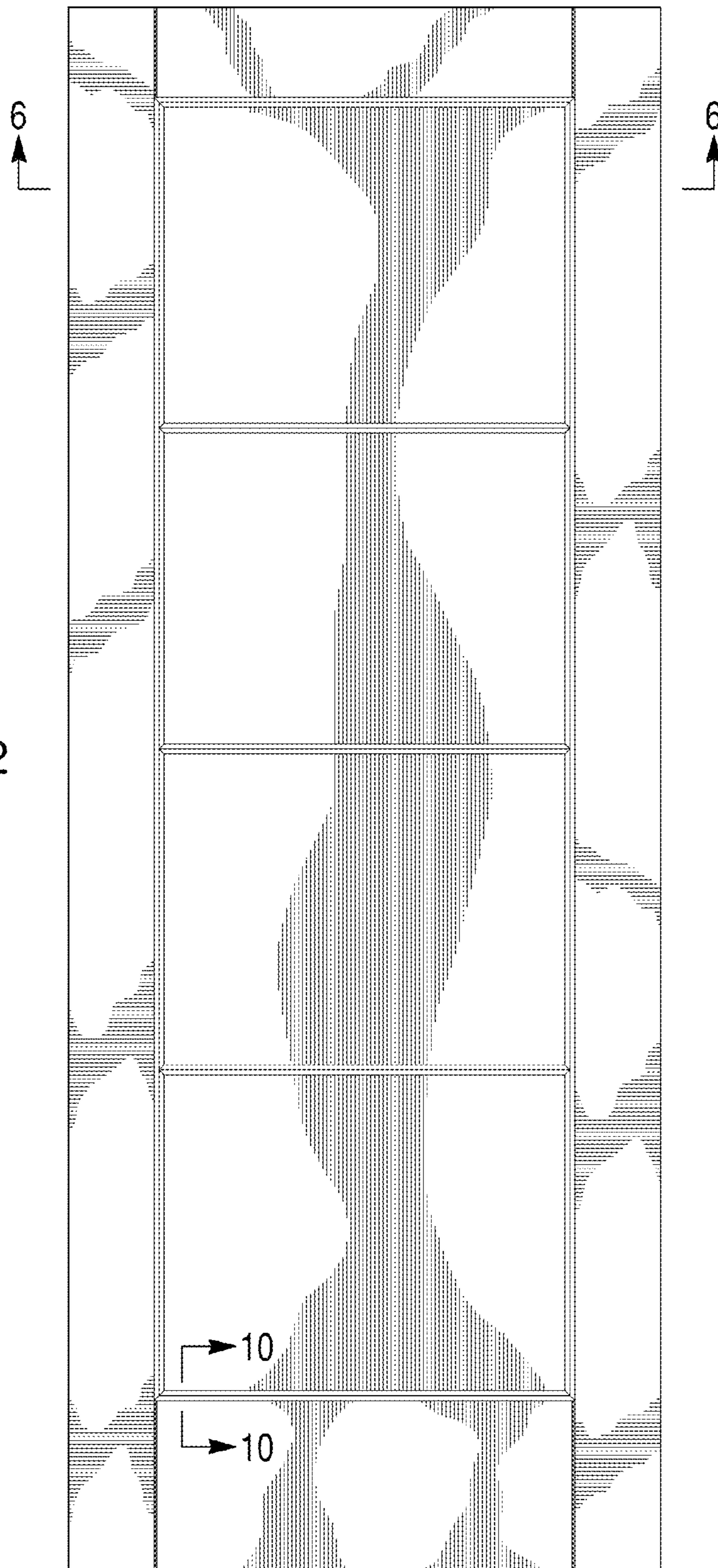

Fig. 3

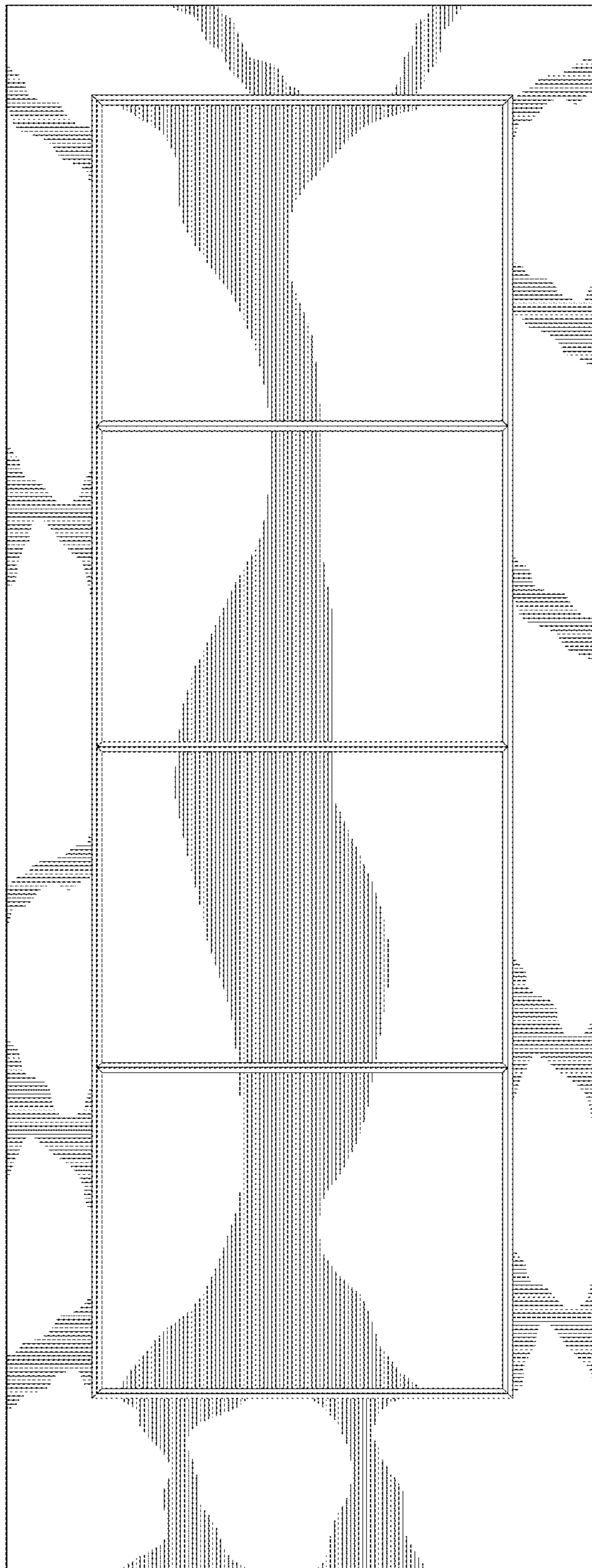

Fig. 4

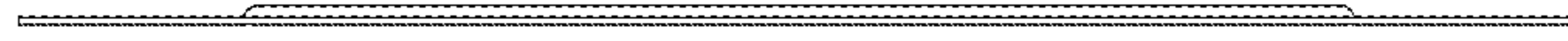

Fig. 5

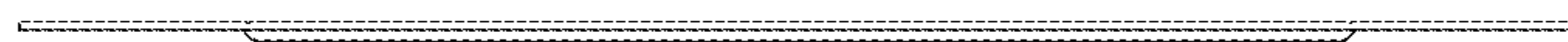

Fig. 6

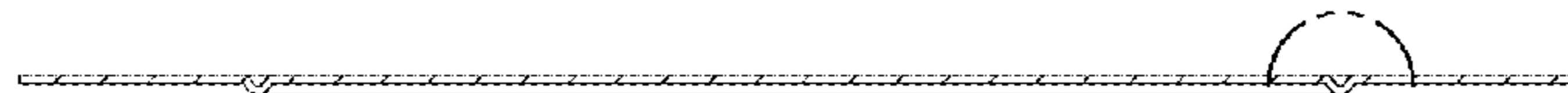

Fig. 7

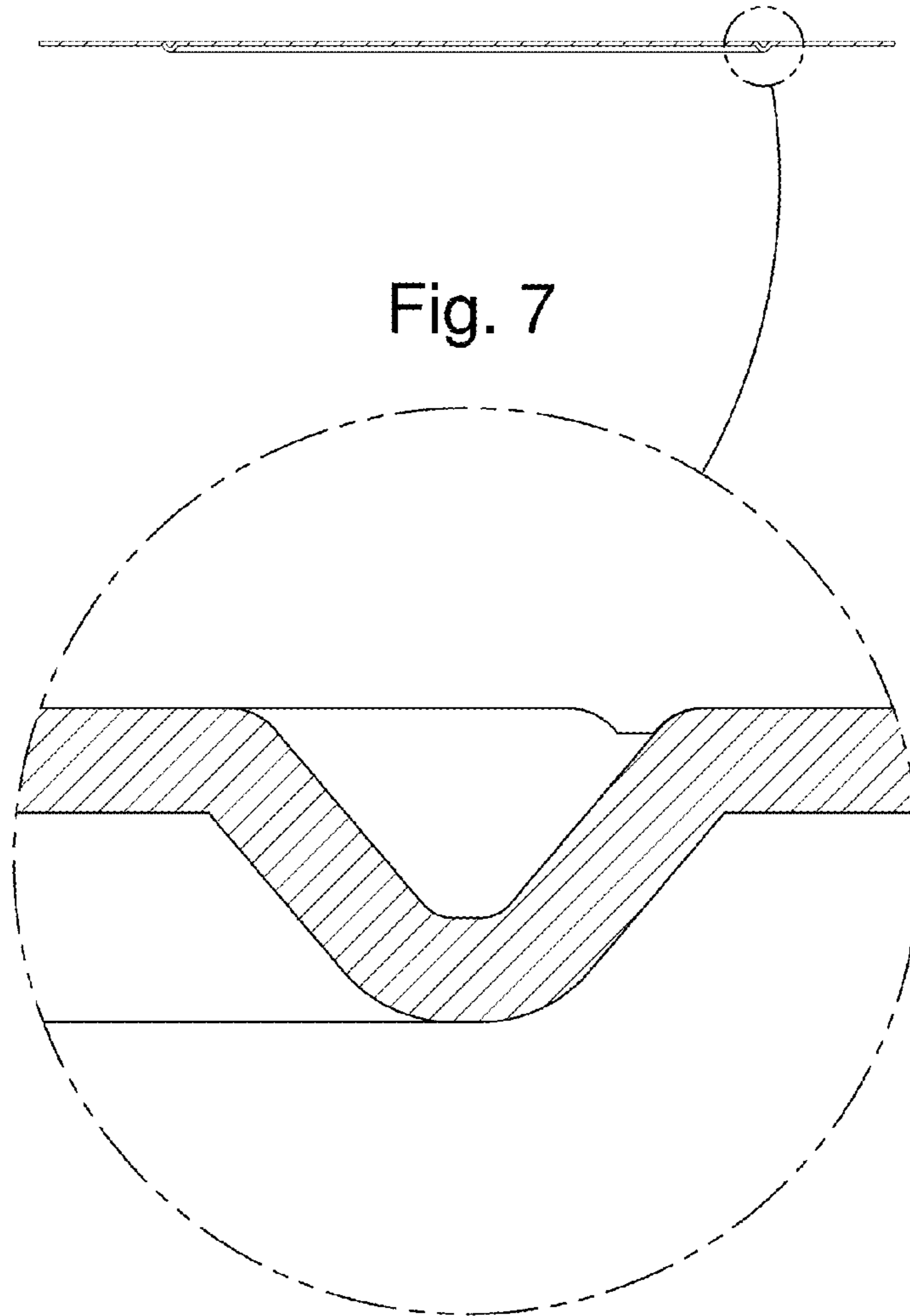

Fig. 8



Fig. 9



Fig. 10

