



US00D687128S

(12) **United States Design Patent**
Bosch

(10) **Patent No.:** **US D687,128 S**

(45) **Date of Patent:** **** Jul. 30, 2013**

(54) **FLUSH LEVER**

D599,440 S * 9/2009 Williams D23/252
D664,243 S * 7/2012 Liao D23/252

(75) Inventor: **Marcus Bosch**, Chicago, IL (US)

* cited by examiner

(73) Assignee: **Liberty Hardware Mfg. Corp.**,
Winston-Salem, NC (US)

Primary Examiner — Robert Delehanty

(74) *Attorney, Agent, or Firm* — Lora J. Graentzdoerffer

(**) Term: **14 Years**

(57) **CLAIM**

The ornamental design for a flush lever, as shown and described.

(21) Appl. No.: **29/414,332**

(22) Filed: **Feb. 28, 2012**

DESCRIPTION

(51) **LOC (9) Cl.** **23-01**

(52) **U.S. Cl.**

USPC **D23/252**

(58) **Field of Classification Search**

USPC D23/238–243, 250, 252, 313; 4/675–678;
137/801

See application file for complete search history.

FIG. 1 is a perspective view of a flush lever showing our design;

FIG. 2 is a front elevational view thereof;

FIG. 3 is a rear elevational view thereof;

FIG. 4 is a top plan view thereof;

FIG. 5 is a bottom plan view thereof;

FIG. 6 is a left side elevational view thereof;

FIG. 7 is a right side elevational view thereof; and,

FIG. 8 is an alternate perspective view thereof.

The broken-line disclosure in the views represents portions of the article in which the claimed design is embodied, but which form no part of the claimed design.

(56) **References Cited**

U.S. PATENT DOCUMENTS

D448,067 S * 9/2001 Pitsch D23/252

D531,271 S * 10/2006 Kohler et al. D23/252

D578,616 S * 10/2008 Fritz et al. D23/250

1 Claim, 8 Drawing Sheets

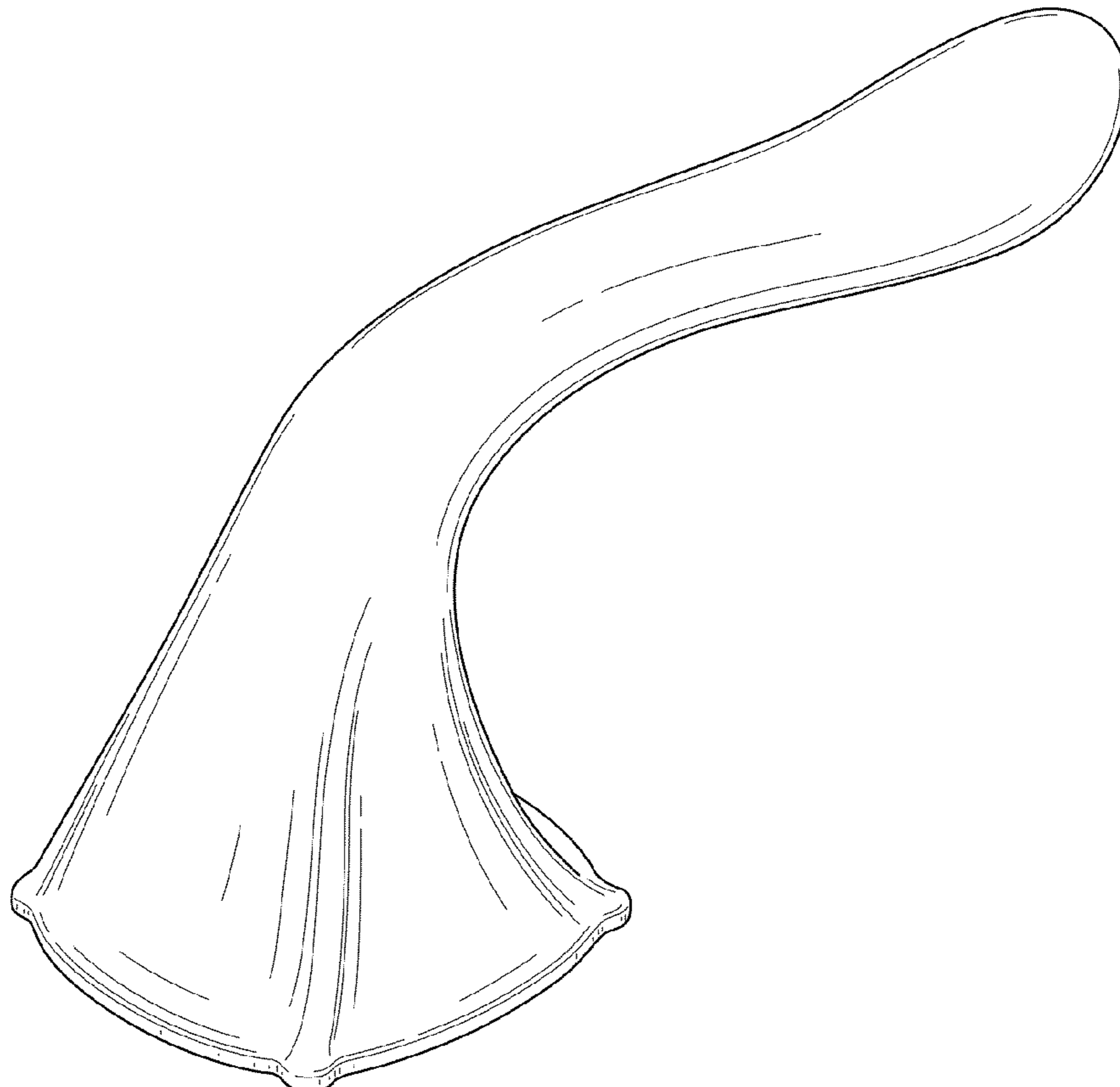

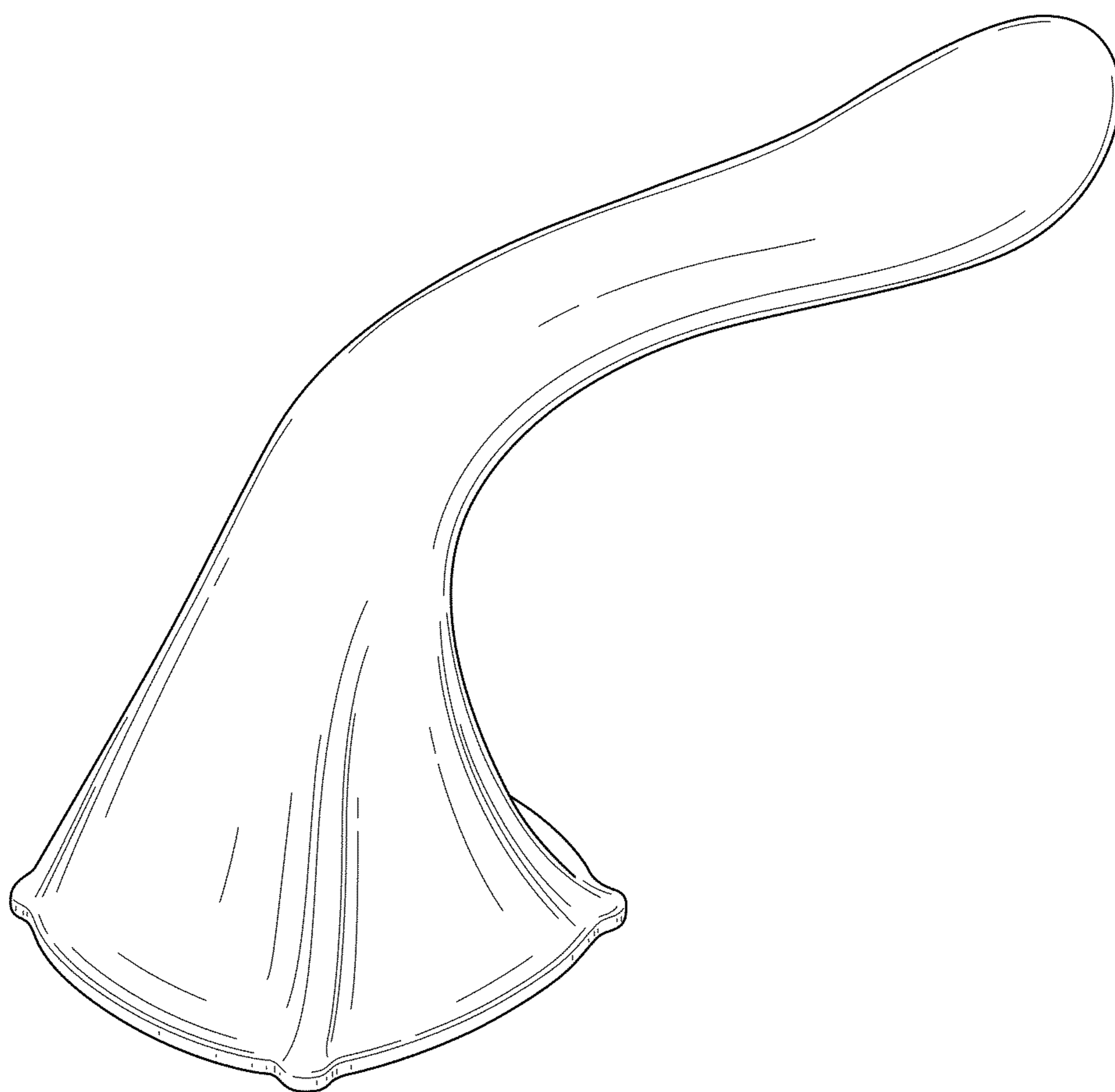

FIG. 1

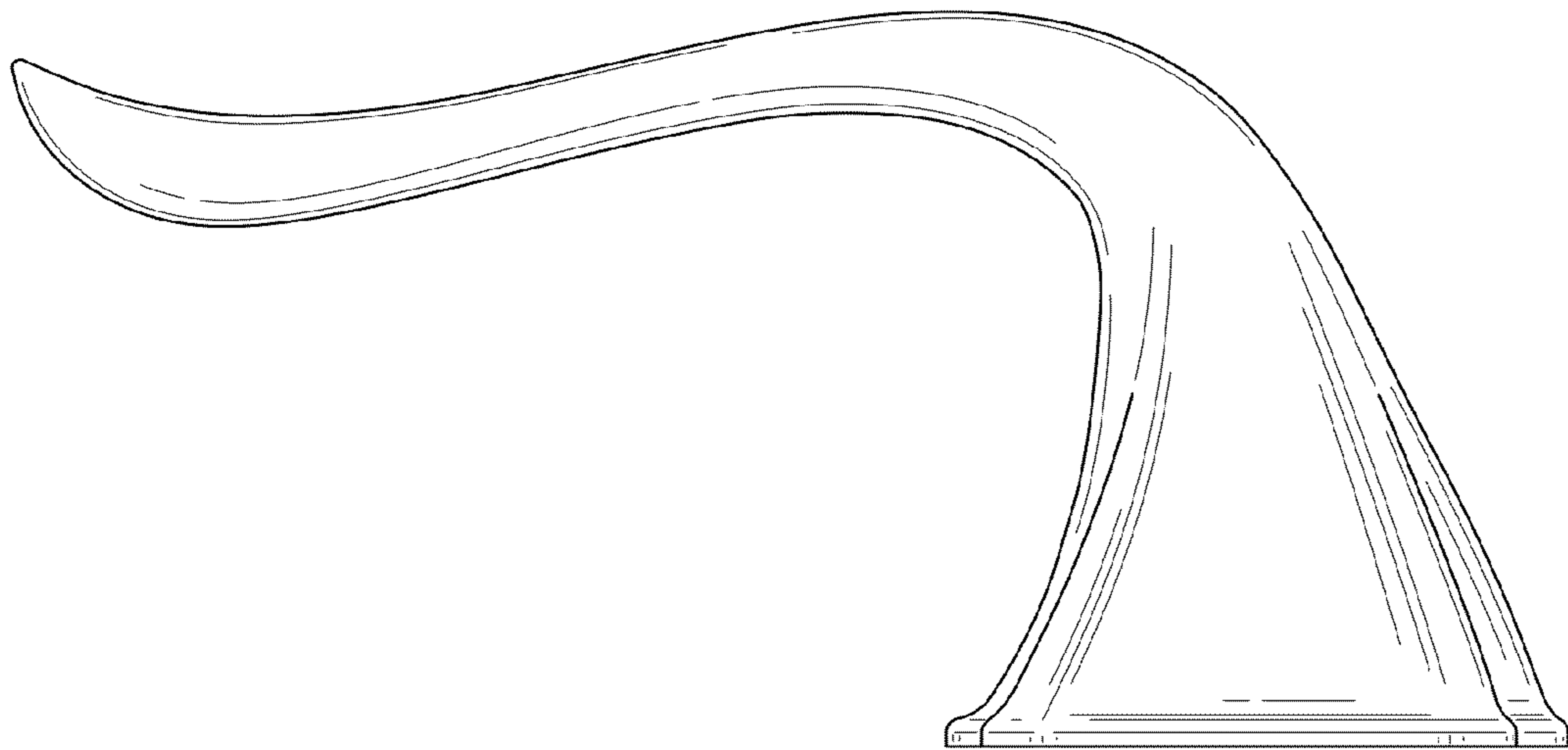

FIG. 2

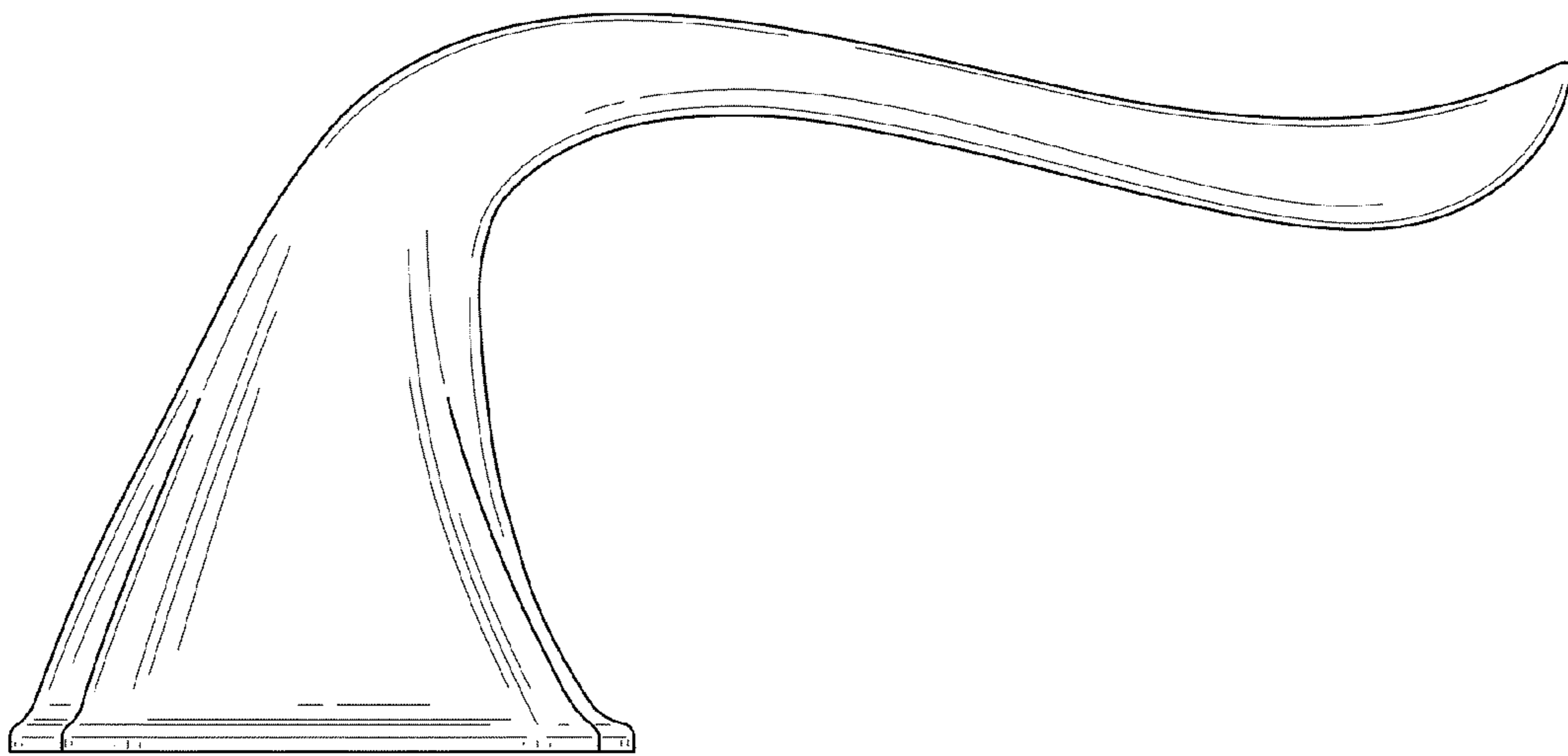

FIG. 3

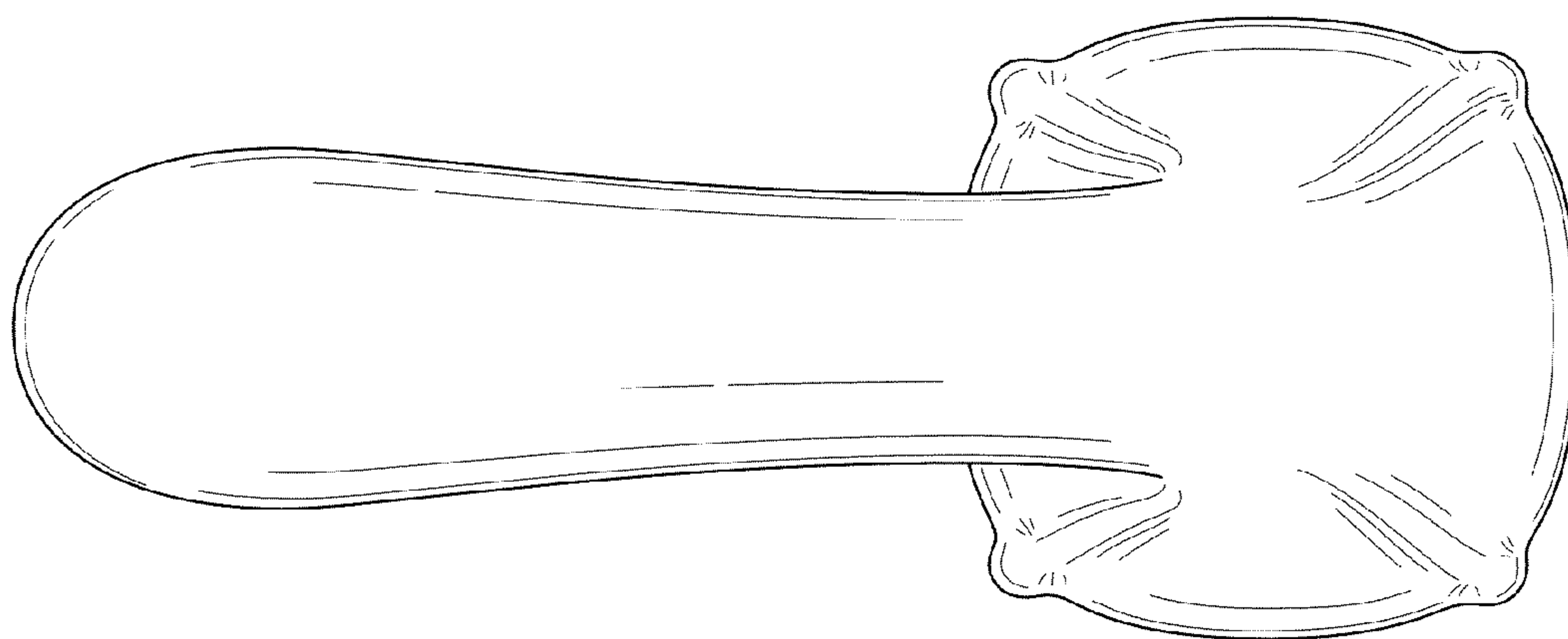

FIG. 4

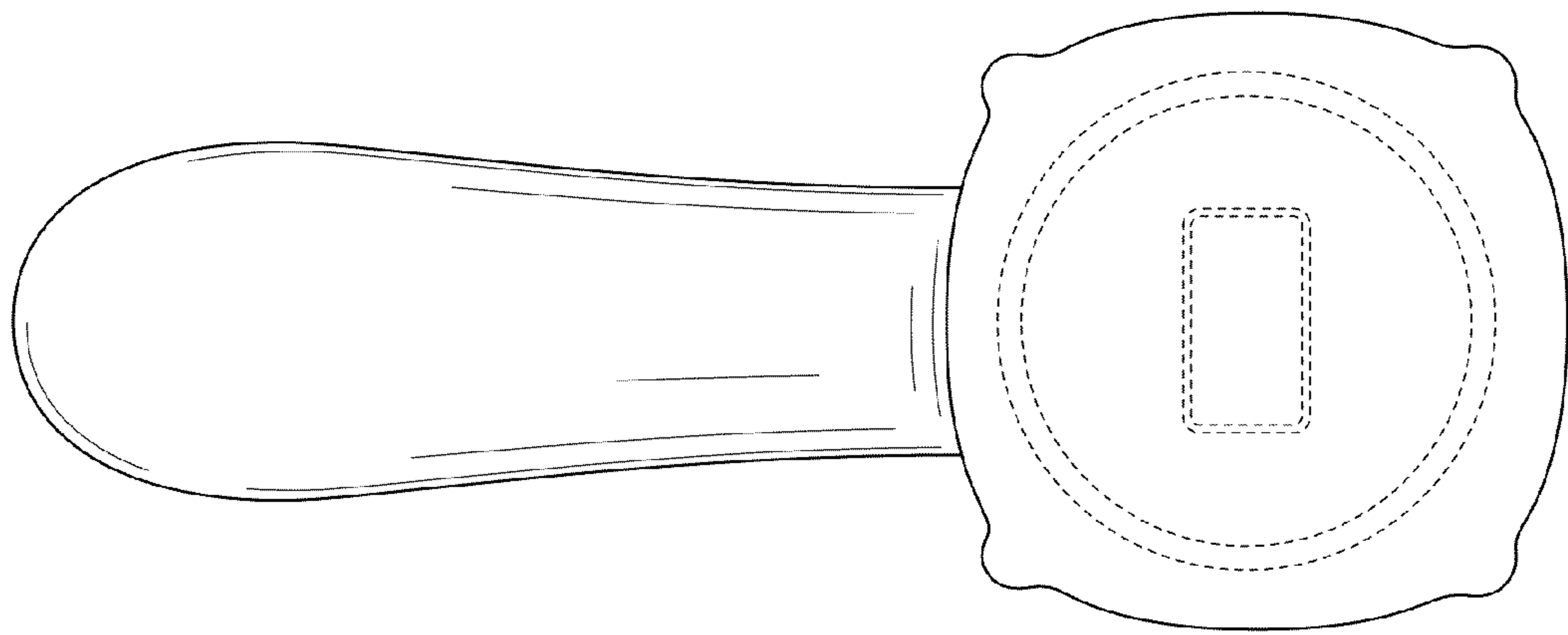

FIG. 5

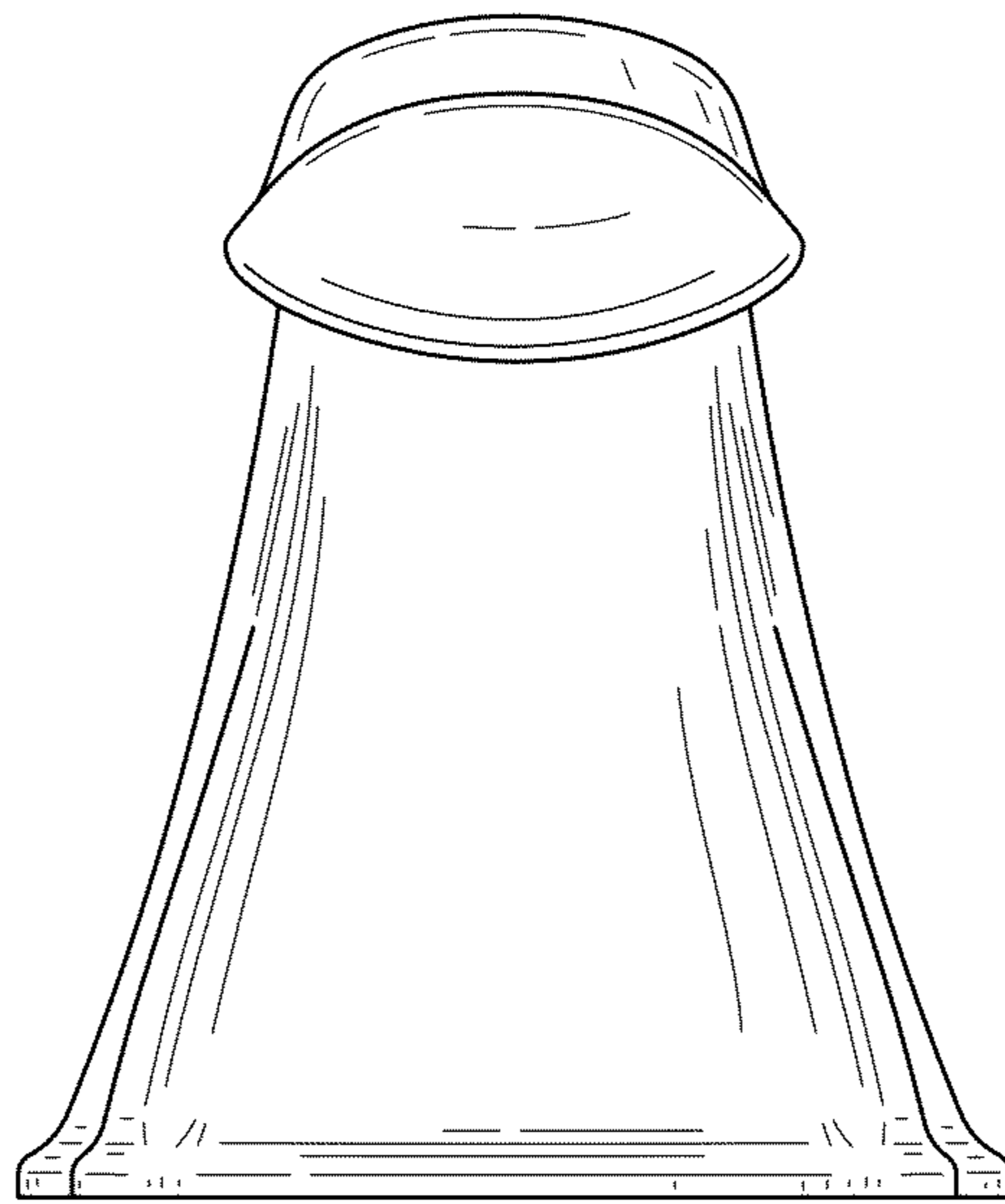

FIG. 6

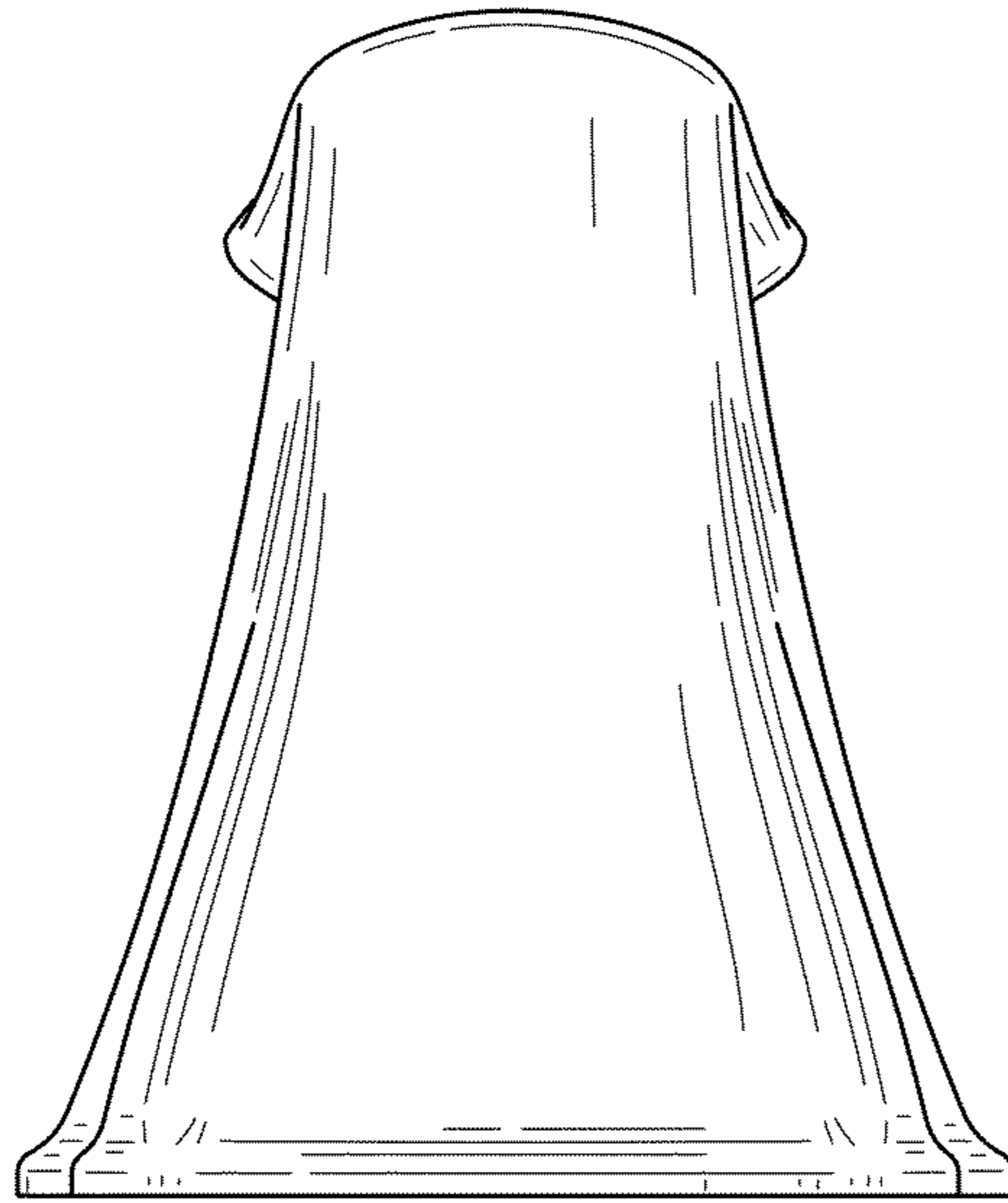

FIG. 7

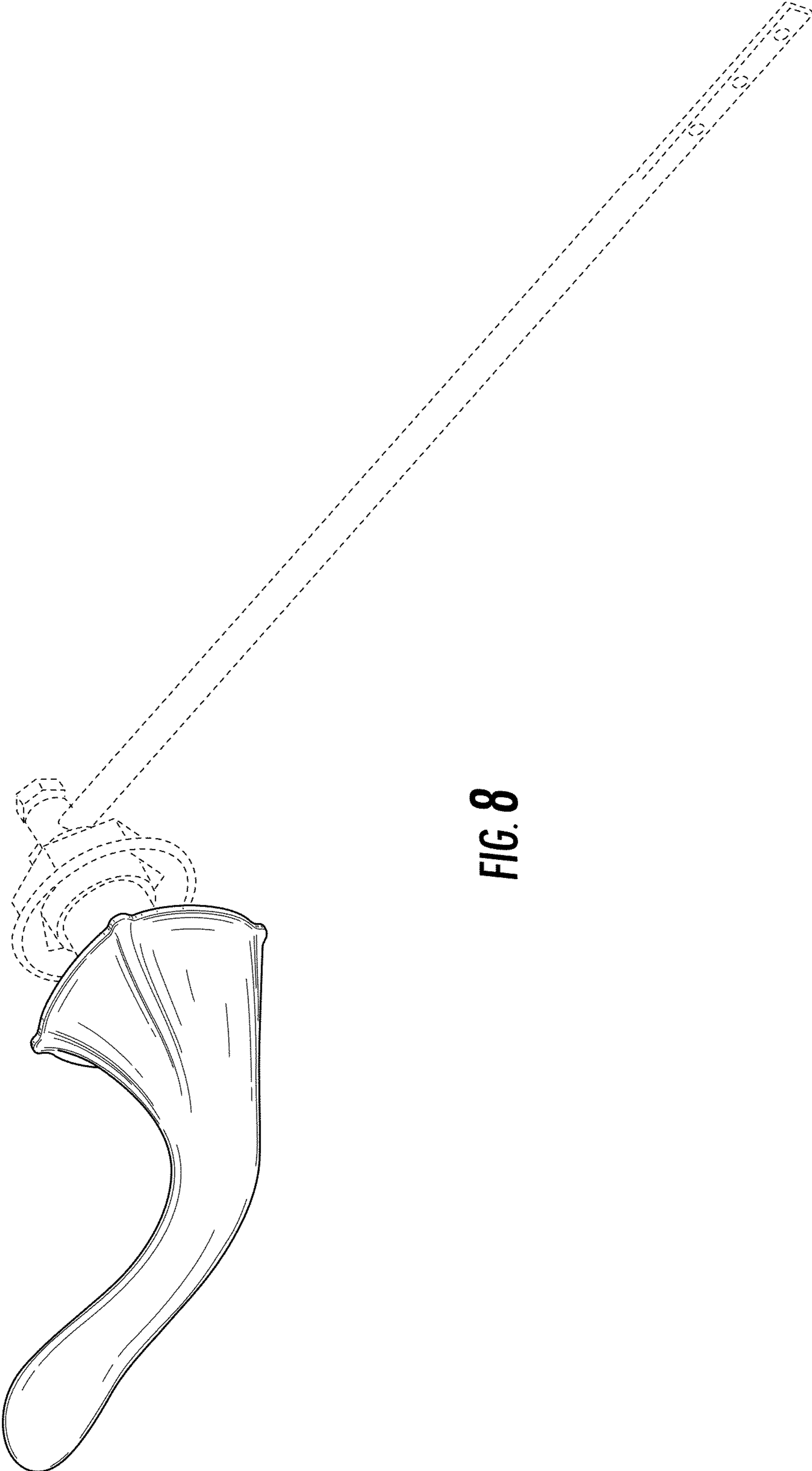

FIG. 8