



US00D687032S

(12) **United States Design Patent**
Sanjo et al.

(10) **Patent No.:** **US D687,032 S**
(45) **Date of Patent:** **** Jul. 30, 2013**

(54) **PERSONAL COMPUTER**

(75) Inventors: **Mikako Sanjo**, Kawasaki (JP); **Eiji Nagao**, Ichikawa (JP); **Hiroyuki Fujita**, Tokyo (JP)

(73) Assignee: **Fujitsu Limited**, Kawasaki (JP)

(**) Term: **14 Years**

(21) Appl. No.: **29/371,645**

(22) Filed: **Jun. 22, 2011**

(30) **Foreign Application Priority Data**

Dec. 27, 2010 (JP) D2010-031037

(51) **LOC (9) Cl.** **14-02**

(52) **U.S. Cl.**
USPC **D14/341**

(58) **Field of Classification Search**

USPC D14/341-347, 137, 138, 138.1, 138 A, D14/138 AA, 138 R, 138 AB, 138 AC, 138 AD, D14/138 C, 138 G, 496, 203.1, 203.3, 203.4, D14/203.5, 203.7, 426, 427, 432, 429, 129, D14/130, 420, 439-441, 448, 125, 126, 147, D14/156, 218, 247-248, 250, 389, 388, 315-318; D10/65, 104; D18/6-7; D21/324, D21/329, 330; D19/26, 59, 60; 455/556.1, 455/556.2, 566, 575.1, 90.3; 379/433.04, 379/433.01, 433.06, 916; 345/169, 173, 901, 345/905; 361/679.26, 679.27, 679.3, 679.55, 361/679.56

See application file for complete search history.

(56) **References Cited**

U.S. PATENT DOCUMENTS

D346,793	S	*	5/1994	Iino et al.	D14/341
D490,420	S	*	5/2004	Solomon et al.	D14/341
D554,640	S	*	11/2007	Ponnert et al.	D14/388
D579,930	S	*	11/2008	Maskatia	D14/341
D584,738	S	*	1/2009	Kim et al.	D14/496
D611,500	S	*	3/2010	Byle et al.	D14/496
D617,793	S	*	6/2010	Chiang et al.	D14/341
D622,240	S	*	8/2010	Liu et al.	D14/126
D622,514	S	*	8/2010	Park et al.	D6/308
D627,666	S	*	11/2010	Lenz et al.	D10/65
D638,815	S	*	5/2011	Lee et al.	D14/138 G
D639,805	S	*	6/2011	Song et al.	D14/341
D640,149	S	*	6/2011	Lenz et al.	D10/65

* cited by examiner

Primary Examiner — Barbara Fox

(74) *Attorney, Agent, or Firm* — Staas & Halsey LLP

(57) **CLAIM**

The ornamental design for a personal computer, as shown and described.

DESCRIPTION

FIG. 1 is a perspective view of front, top plan and right side of a personal computer showing our new design;
FIG. 2 is a front view thereof;
FIG. 3 is a rear view thereof;
FIG. 4 is a left side view thereof;
FIG. 5 is a right side view thereof;
FIG. 6 is a top plan view thereof;
FIG. 7 is a bottom view thereof; and,
FIG. 8 is an end view at A-A' thereof.
The broken lines shown in the drawings represent portions of the personal computer which form no part of the claimed design.

1 Claim, 5 Drawing Sheets

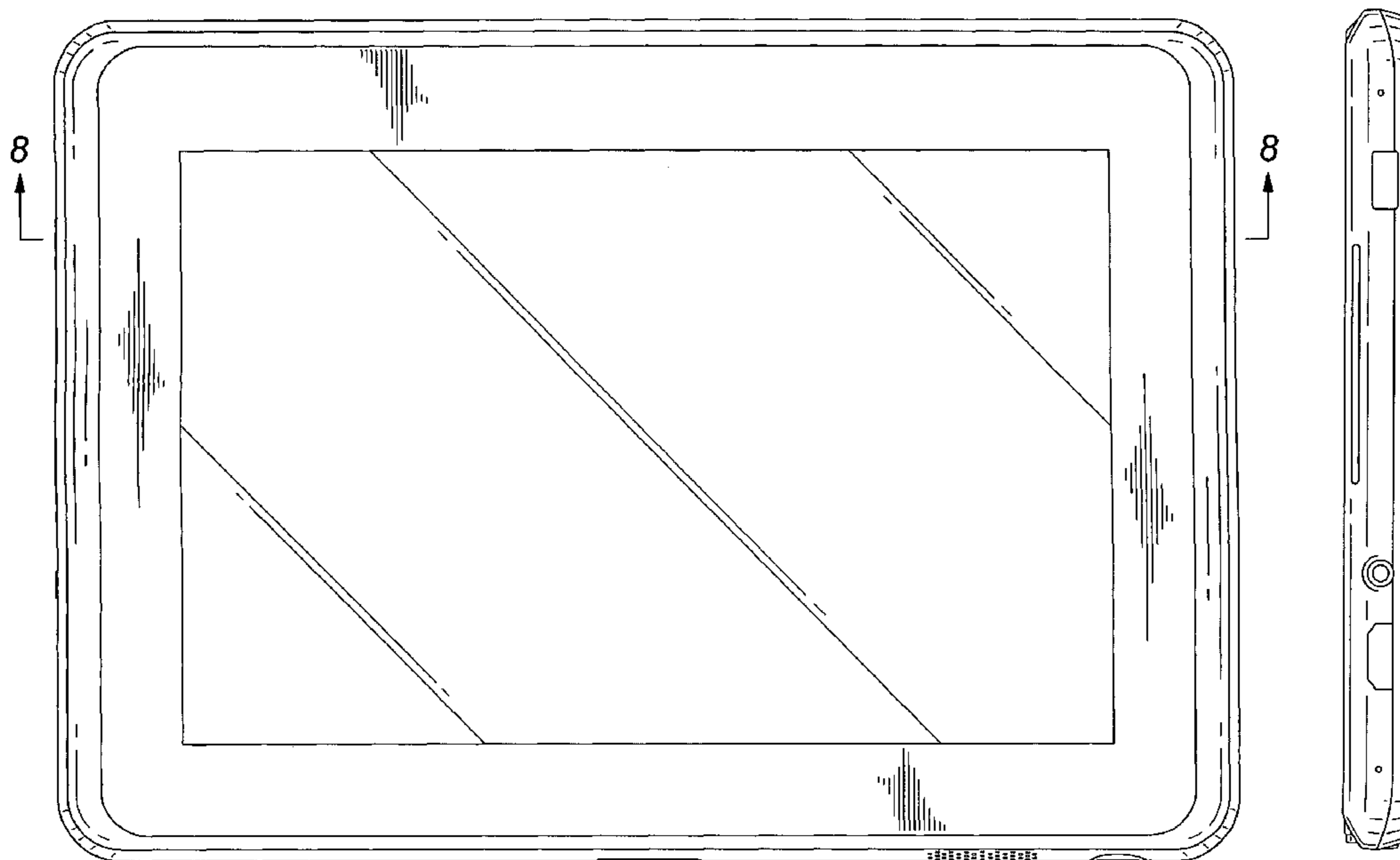

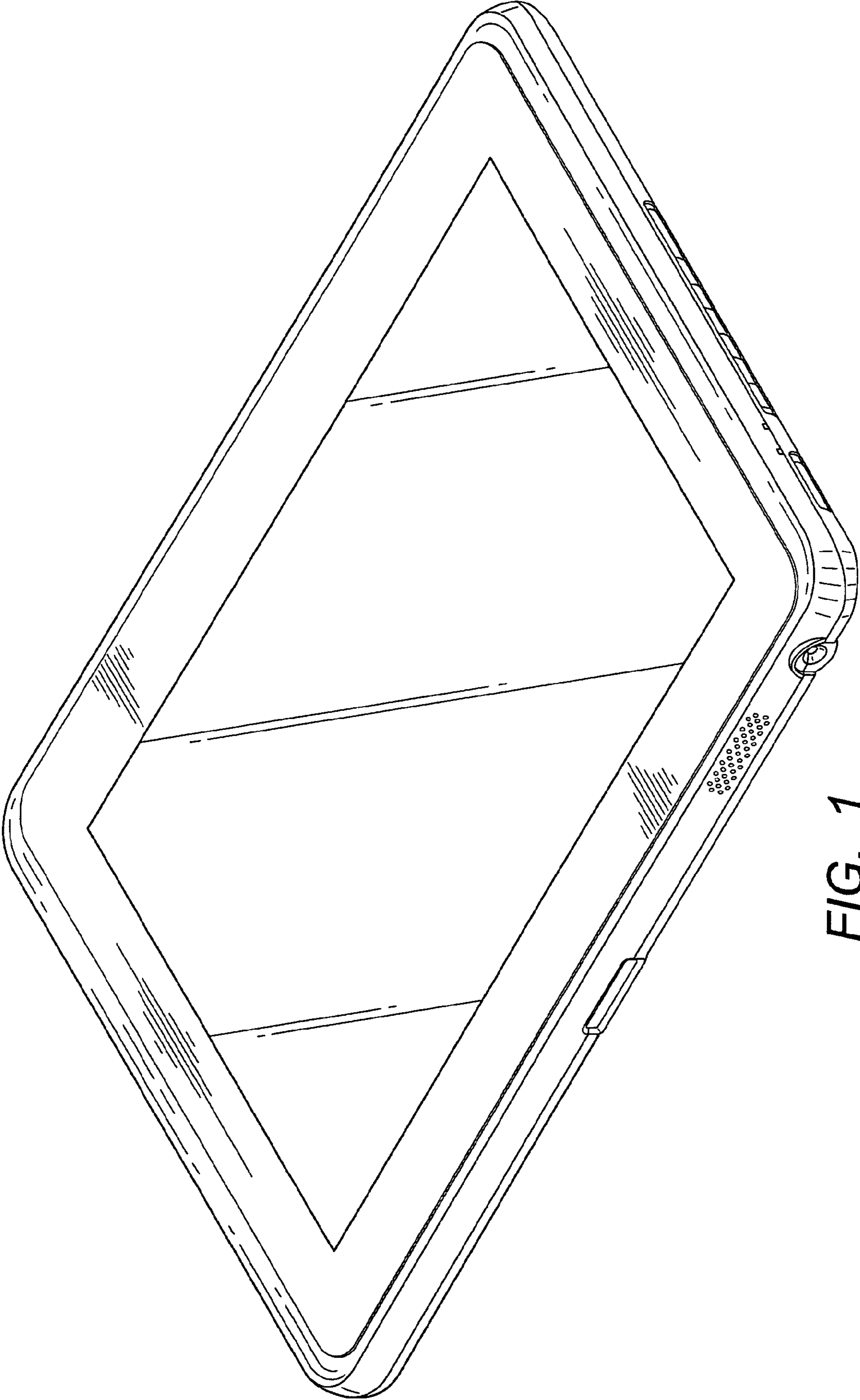

FIG. 1

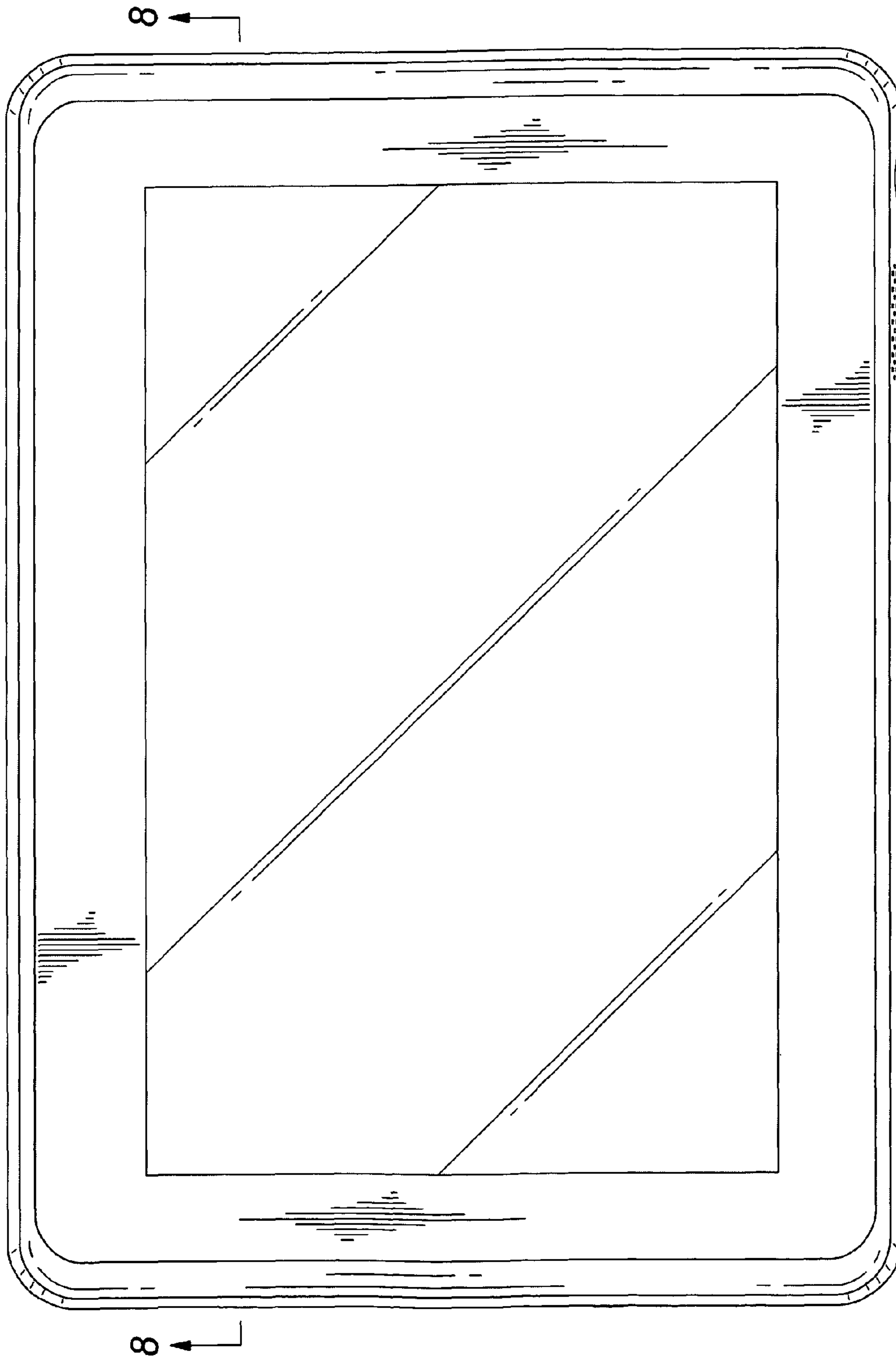

FIG. 2

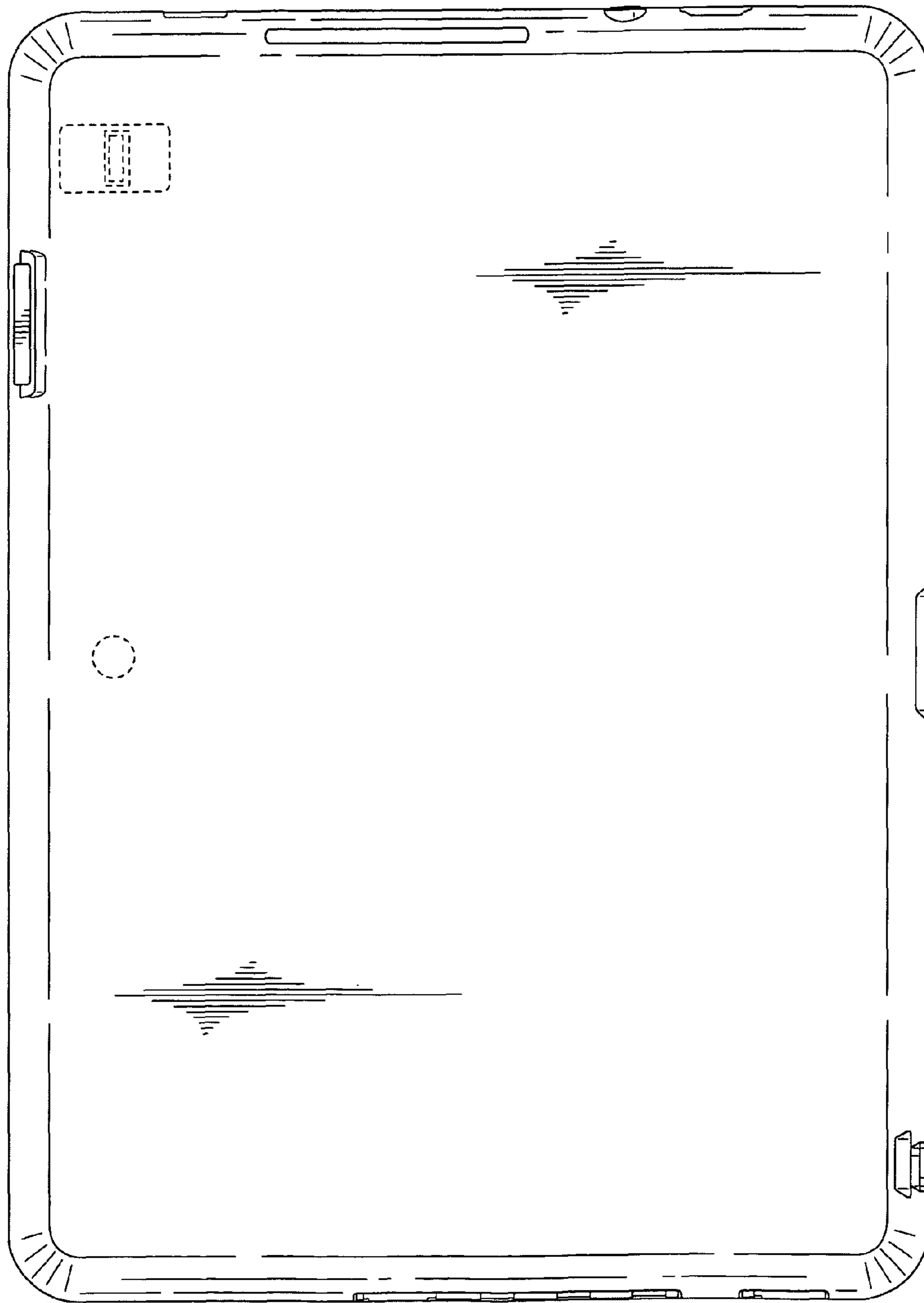

FIG. 3

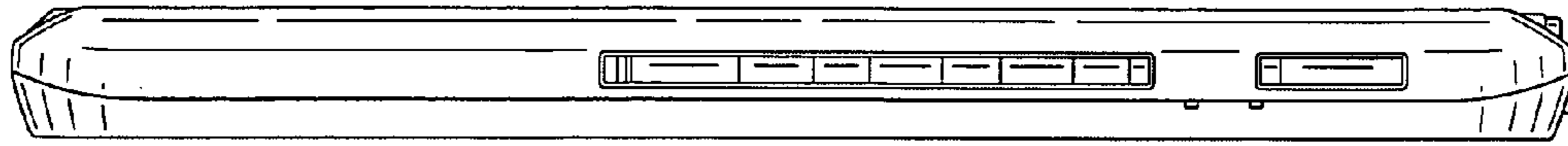

FIG. 5

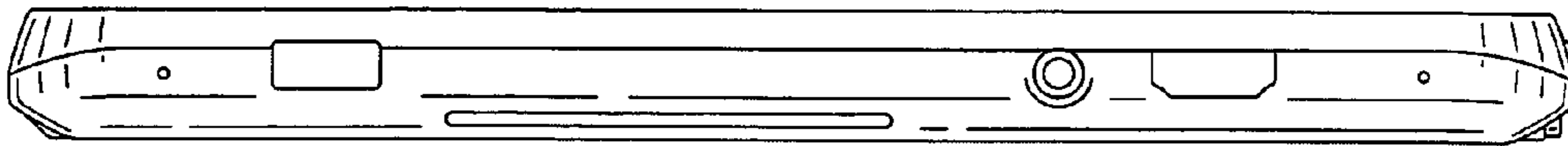

FIG. 4

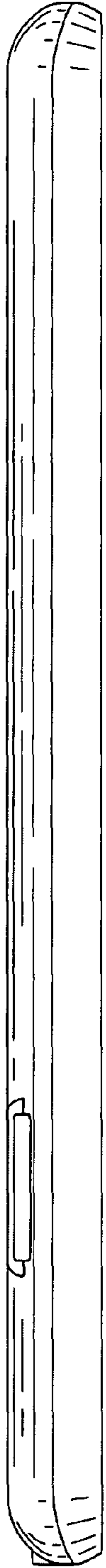

FIG. 6



FIG. 7

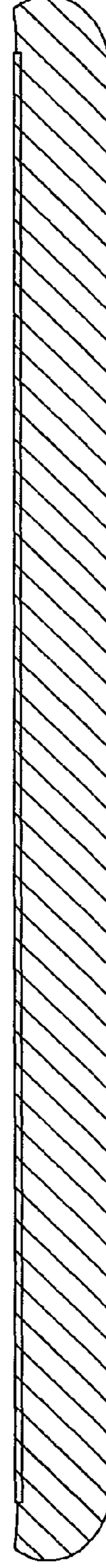

FIG. 8