



US00D687002S

(12) **United States Design Patent**
Song et al.

(10) **Patent No.:** **US D687,002 S**

(45) **Date of Patent:** **** Jul. 30, 2013**

(54) **MOBILE TERMINAL**

(75) Inventors: **Han-Gil Song**, Seoul (KR); **Min-Hyouk Lee**, Seoul (KR); **Jung-Hyuck Im**, Yongin-si (KR)

(73) Assignee: **Samsung Electronics Co., Ltd.**, Suwon-si (KR)

(**) Term: **14 Years**

(21) Appl. No.: **29/422,745**

(22) Filed: **May 23, 2012**

(30) **Foreign Application Priority Data**

Dec. 23, 2011 (KR) 30-2011-0054976

(51) **LOC (9) Cl.** **14-03**

(52) **U.S. Cl.**

USPC **D14/138 G**

(58) **Field of Classification Search**

USPC D14/138 R, 138 AD, 138 AC, 138 C, D14/138 G, 191, 203.1–203.8, 496, 138 AA, D14/138 AB, 137, 147, 218, 341–347, 247–248; D10/65, 78, 104; D13/168; D18/7; 455/566, 575.1, 575.3, 575.4

See application file for complete search history.

(56) **References Cited**

U.S. PATENT DOCUMENTS

D511,342 S * 11/2005 Chien D14/346
D548,713 S * 8/2007 Lee et al. D14/138 AD
D549,205 S * 8/2007 Cho D14/138 AD
D582,882 S * 12/2008 Kim et al. D14/138 AD
D601,535 S * 10/2009 Huang D14/138 AD
D606,958 S * 12/2009 Knoppert et al. D14/138 AD
D611,025 S * 3/2010 Yu D14/138 G
D624,519 S * 9/2010 Shen et al. D14/138 AD

D632,270 S * 2/2011 Arnholt et al. D14/138 AB
D635,541 S * 4/2011 Park et al. D14/138 G
D637,996 S * 5/2011 Kim et al. D14/203.7
D640,578 S * 6/2011 Aihara et al. D10/65
D654,048 S * 2/2012 Ichinose et al. D14/138 G
D656,477 S * 3/2012 Yi et al. D14/138 G
D666,573 S * 9/2012 Kim et al. D14/138 AD
D671,086 S * 11/2012 Yu et al. D14/138 G
D671,089 S * 11/2012 Joung et al. D14/138 G
D676,400 S * 2/2013 Kitamura D14/138 G
D676,401 S * 2/2013 Choi D14/138 G
2011/0237314 A1* 9/2011 Kajiwara et al. 455/575.4

OTHER PUBLICATIONS

Acer Liquid C1, announced Jan. 2013, [online], [retrieved on Mar. 4, 2013]. Retrieved from Internet ,<URL: <http://www.gsmarena.com>>.*

Alcatel OT-993, announced Aug. 2012, [online], [retrieved on Aug. 21, 2012]. Retrieved from Internet ,<URL: <http://www.gsmarena.com>>.*

* cited by examiner

Primary Examiner — Bridget L Eland

(74) *Attorney, Agent, or Firm* — NSIP Law

(57) **CLAIM**

The ornamental design for a mobile terminal, as shown and described.

DESCRIPTION

FIG. 1 is a front perspective view of a mobile terminal; FIG. 2 is a front view of the mobile terminal of FIG. 1; FIG. 3 is a rear view of the mobile terminal of FIG. 1; FIG. 4 is a left-side view of the mobile terminal of FIG. 1; FIG. 5 is a right-side view of the mobile terminal of FIG. 1; FIG. 6 is a top plan view of the mobile terminal of FIG. 1; and, FIG. 7 is a bottom plan view of the mobile terminal of FIG. 1.

1 Claim, 5 Drawing Sheets

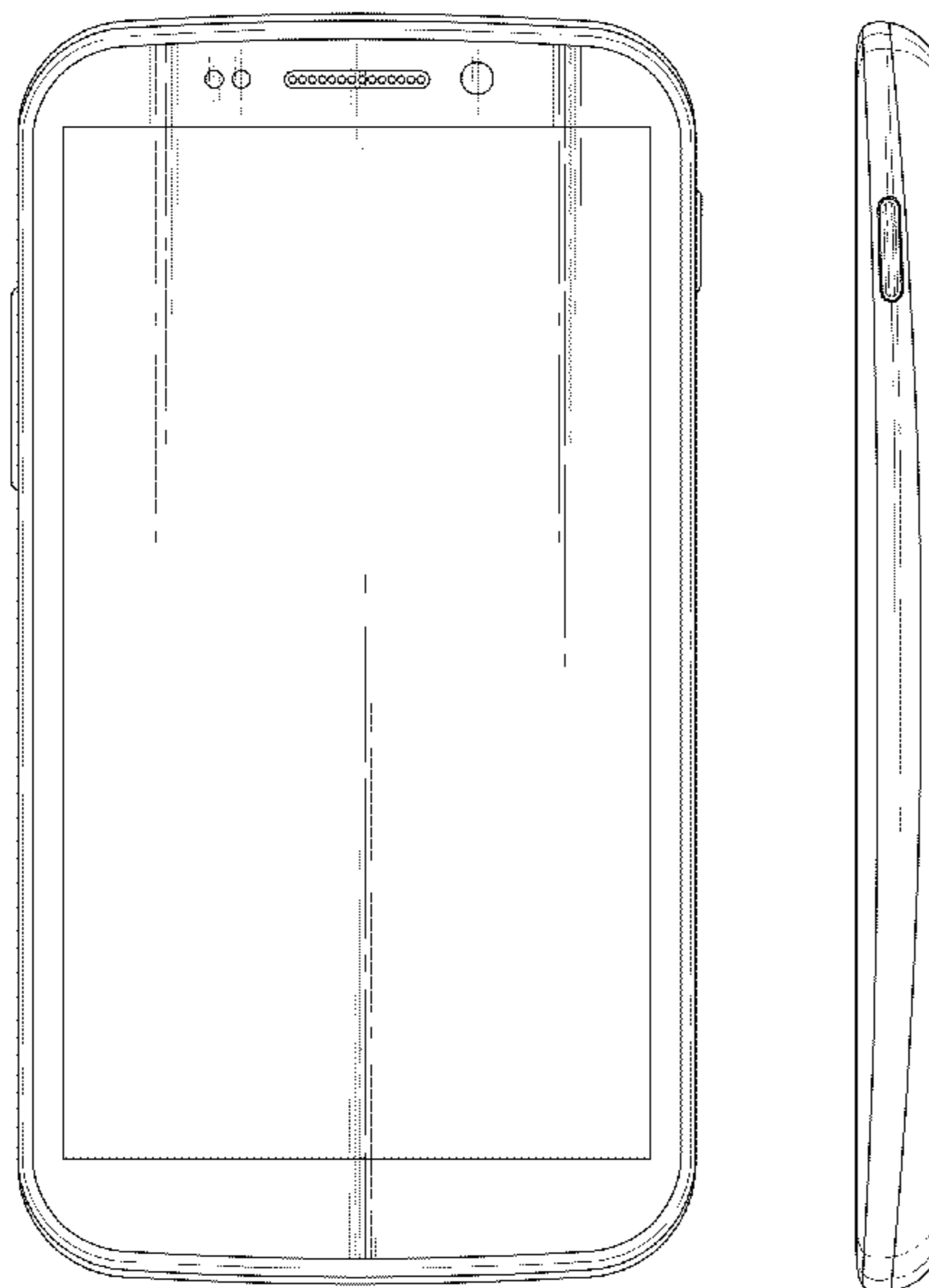

FIG. 1

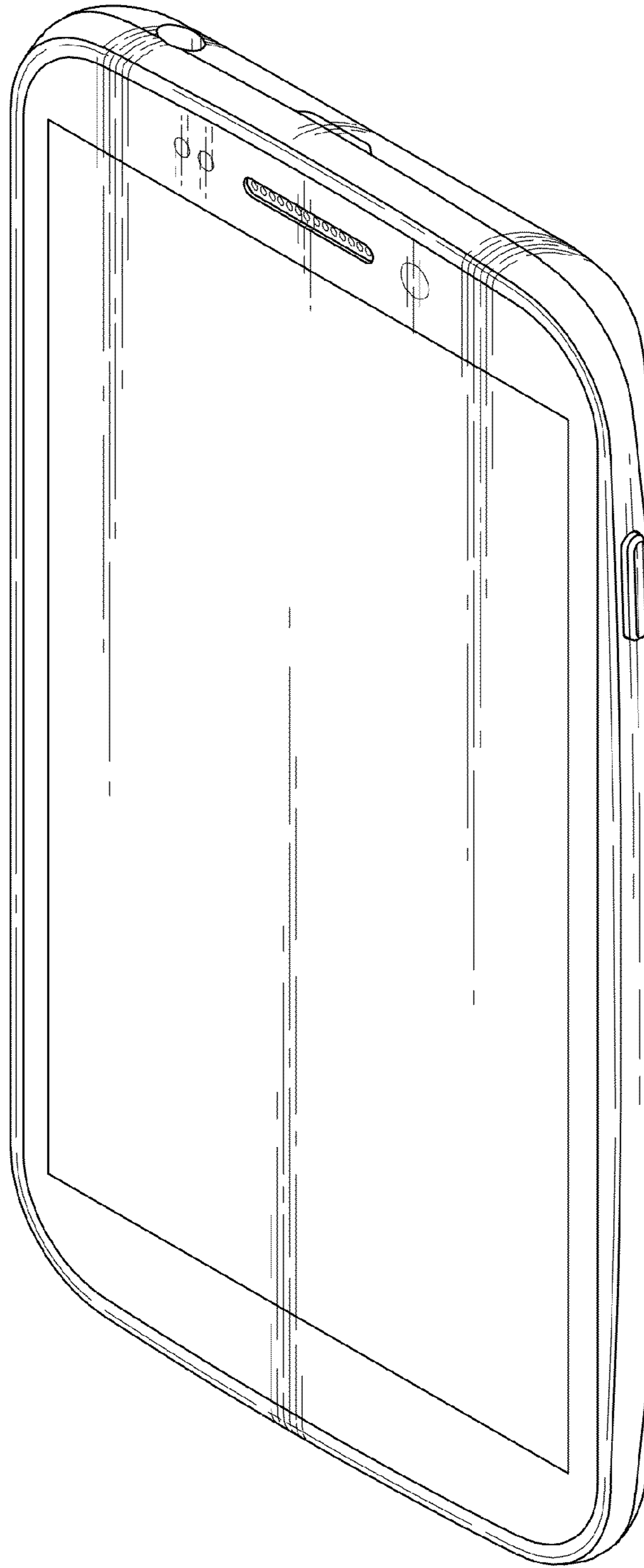

FIG. 2

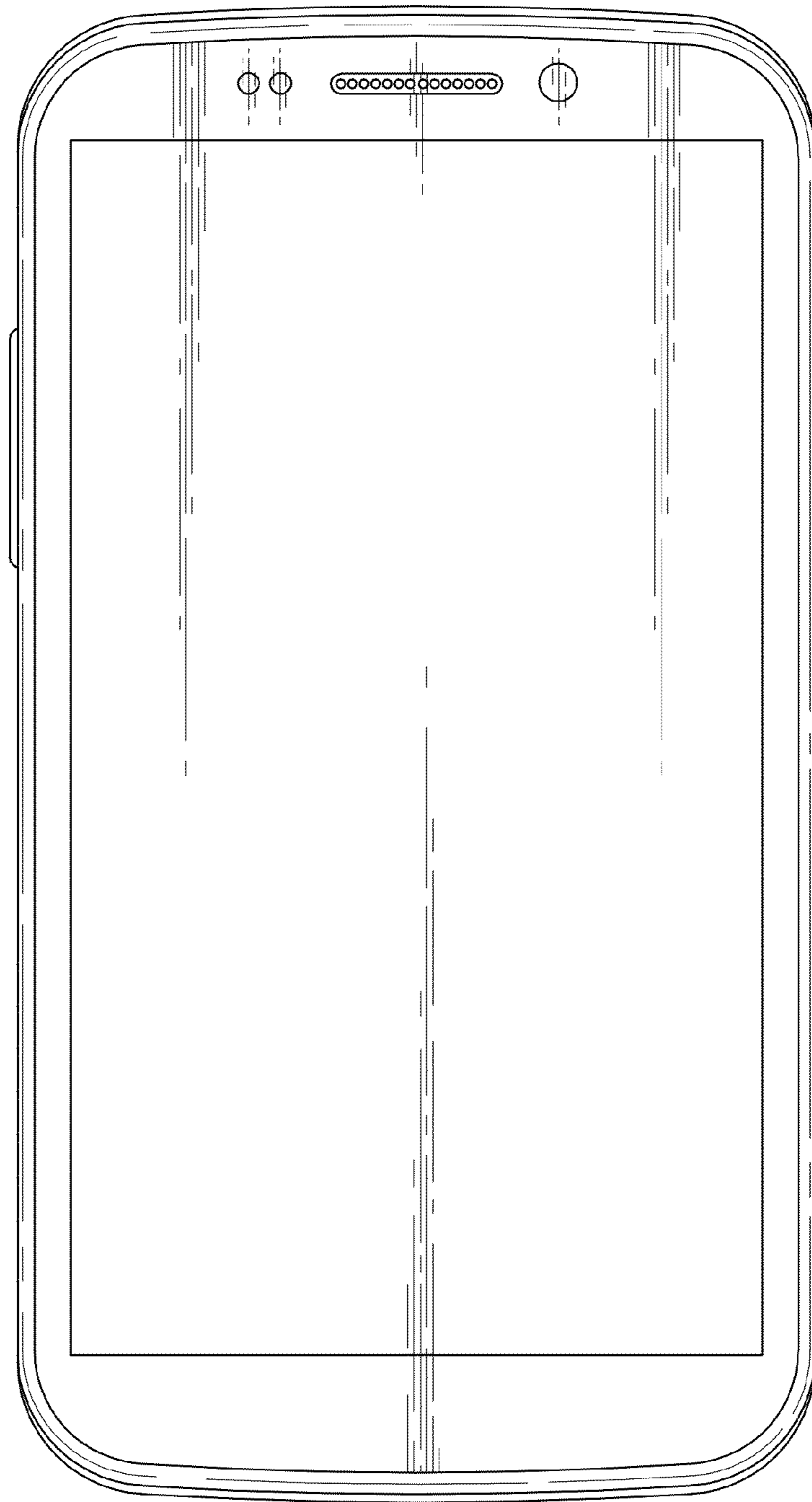

FIG. 3

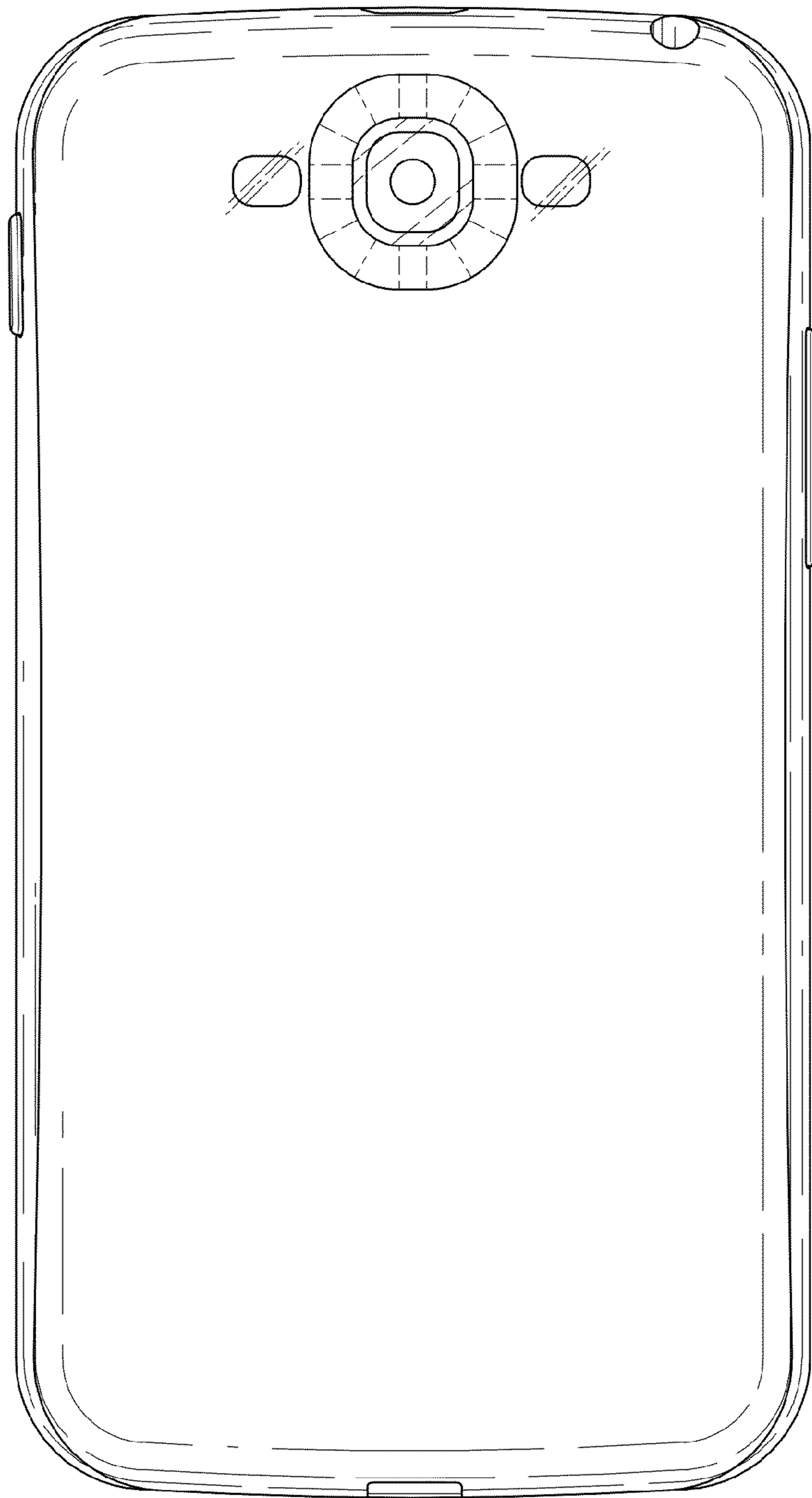

FIG. 4

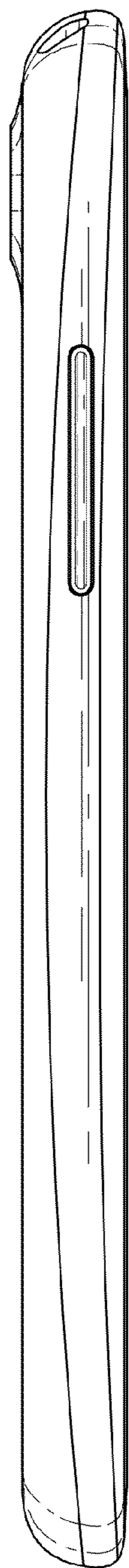

FIG. 5

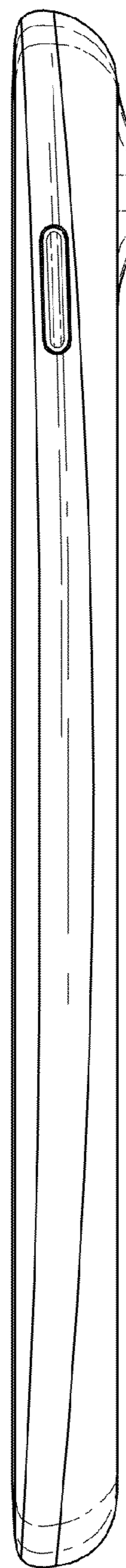

FIG. 6

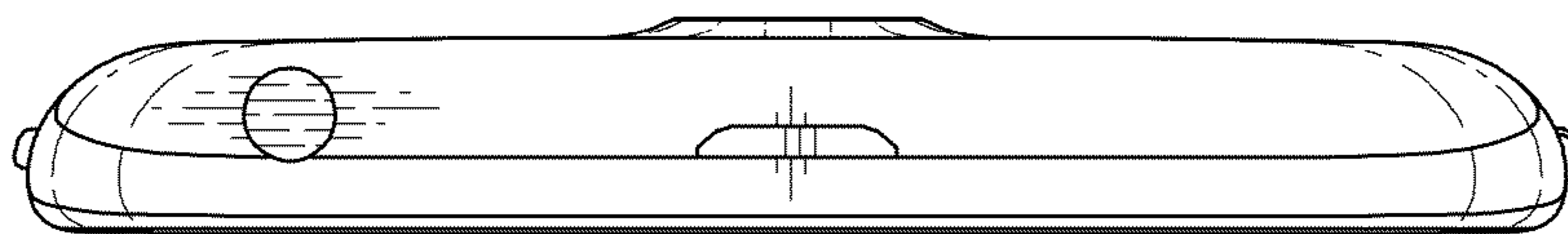

FIG. 7

