



US00D686944S

(12) **United States Design Patent**
Couzyn

(10) **Patent No.:** **US D686,944 S**
(45) **Date of Patent:** **** Jul. 30, 2013**

- (54) **BUCKLE**
- (71) Applicant: **Rhys James Couzyn, Ballito (ZA)**
- (72) Inventor: **Rhys James Couzyn, Ballito (ZA)**
- (**) Term: **14 Years**
- (21) Appl. No.: **29/436,275**
- (22) Filed: **Nov. 2, 2012**
- (51) **LOC (9) Cl.** **02-07**
- (52) **U.S. Cl.**
USPC **D11/216**
- (58) **Field of Classification Search**
USPC D11/1-2, 200-201, 206-210, 214-218;
24/163 R, 169-171, 173, 177-179, 191,
194-195, 197, 200, 614-616, 625, 198
See application file for complete search history.

- D585,331 S * 1/2009 Kumazaki et al. D11/216
- D618,136 S * 6/2010 Ward D11/200
- D649,492 S * 11/2011 Grimm et al. D11/216
- D651,122 S * 12/2011 Vincent et al. D11/216

* cited by examiner

Primary Examiner — Ralf Seifert
(74) *Attorney, Agent, or Firm* — Young & Thompson

(57) **CLAIM**
The ornamental design for a buckle, as shown and described.

DESCRIPTION

FIG. 1 is a front, left side, and top perspective view of a buckle showing the new design;
 FIG. 2 is a front elevation view thereof;
 FIG. 3 is a bottom plan view thereof;
 FIG. 4 is a rear elevation view thereof;
 FIG. 5 is a side elevation view thereof;
 FIG. 6 is a top plan view thereof;
 FIG. 7 is a rear elevation view of the buckle in an open configuration;
 FIG. 8 is a bottom plan view thereof;
 FIG. 9 is a front elevation view thereof;
 FIG. 10 is a side elevation view thereof;
 FIG. 11 is a perspective view thereof; and,
 FIG. 12 is a top plan view thereof.

- (56) **References Cited**
U.S. PATENT DOCUMENTS
D153,895 S * 5/1949 Oppenheimer D11/216
4,051,611 A * 10/1977 Chalmers 36/50.5
D284,900 S * 8/1986 Chalmers et al. D11/200
D318,943 S * 8/1991 Marega D2/978
D363,690 S * 10/1995 Gallon et al. D11/216
D376,771 S * 12/1996 Cheng D11/216
D398,559 S * 9/1998 Chen D11/215

1 Claim, 12 Drawing Sheets

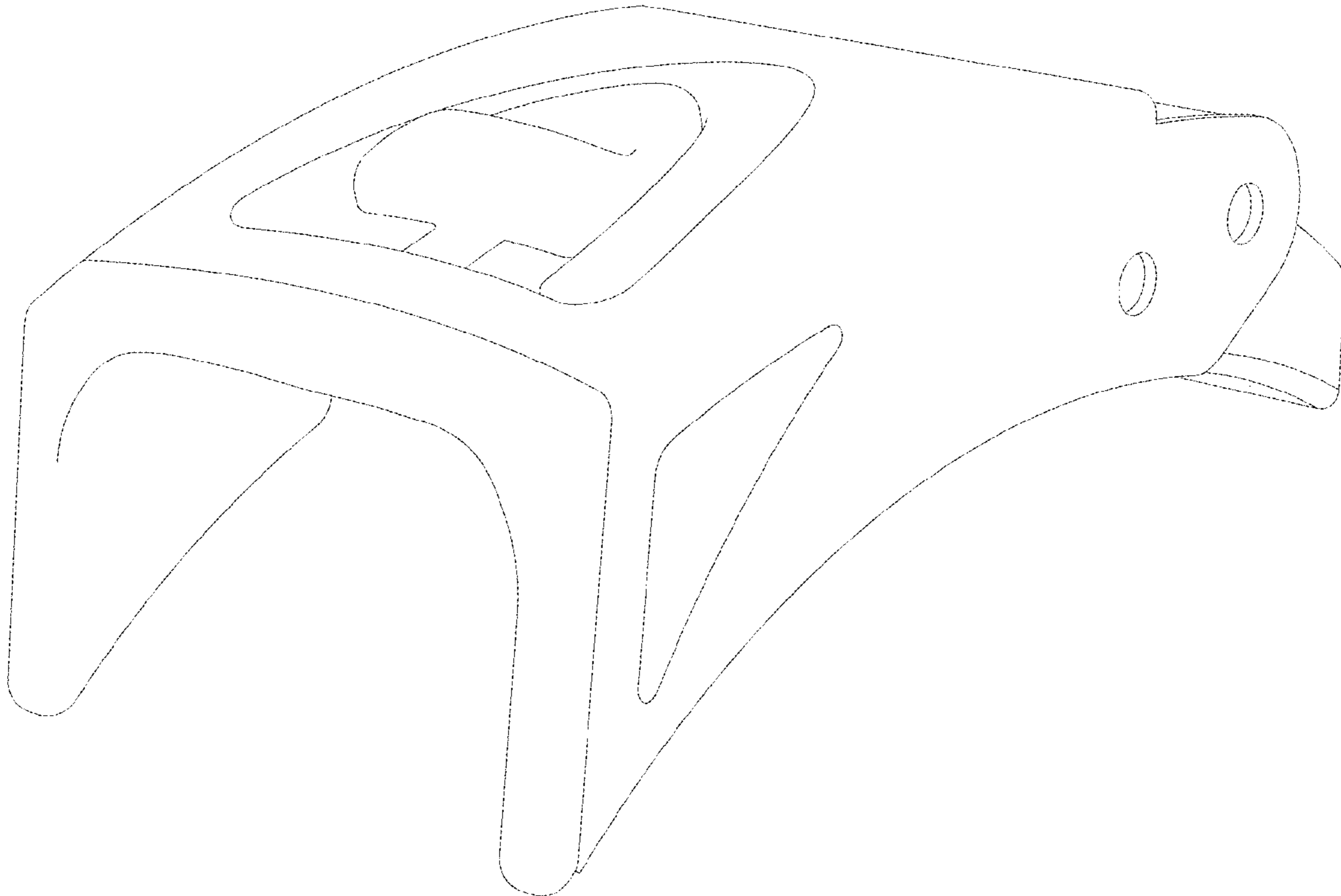

Fig. 1

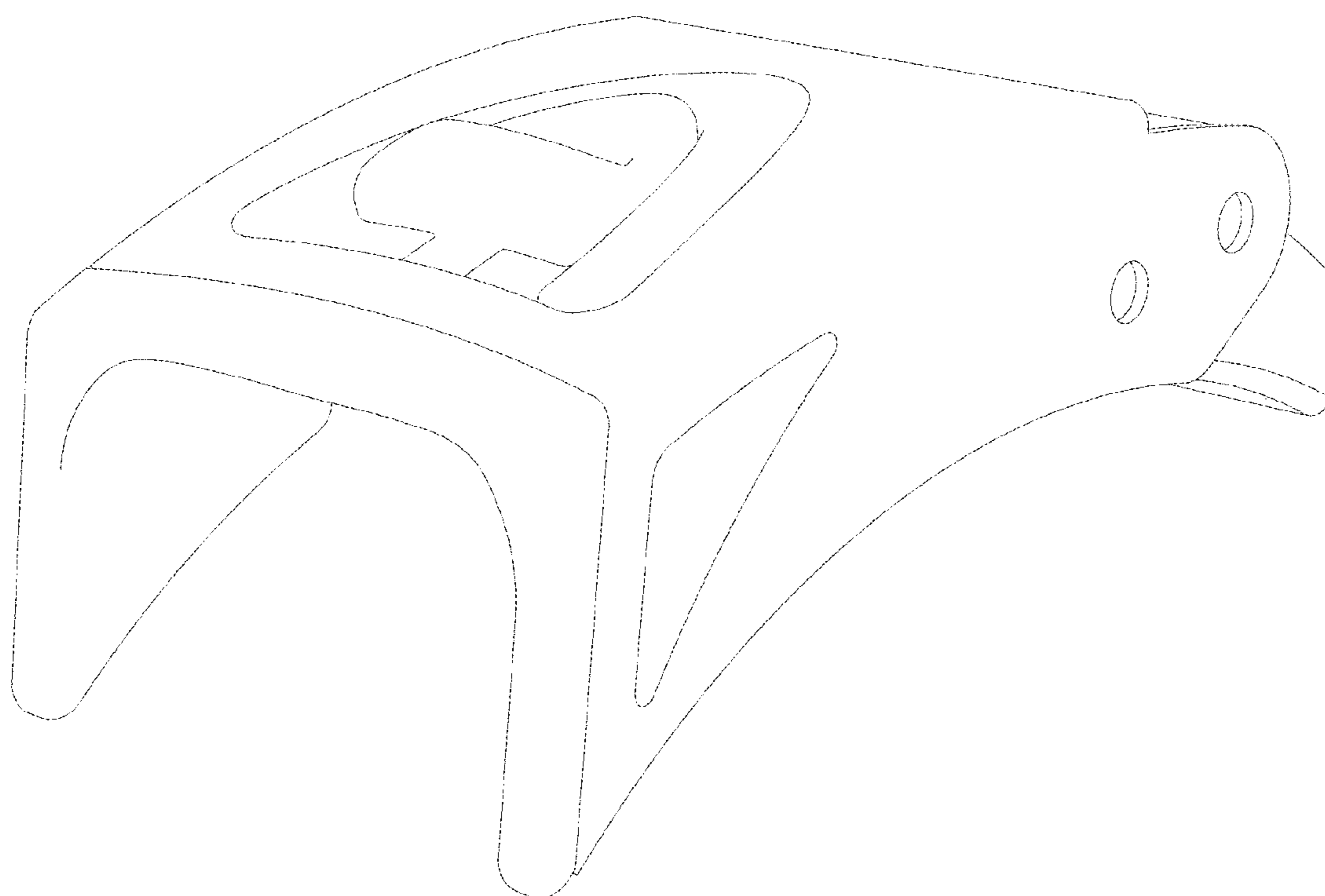

Fig. 2

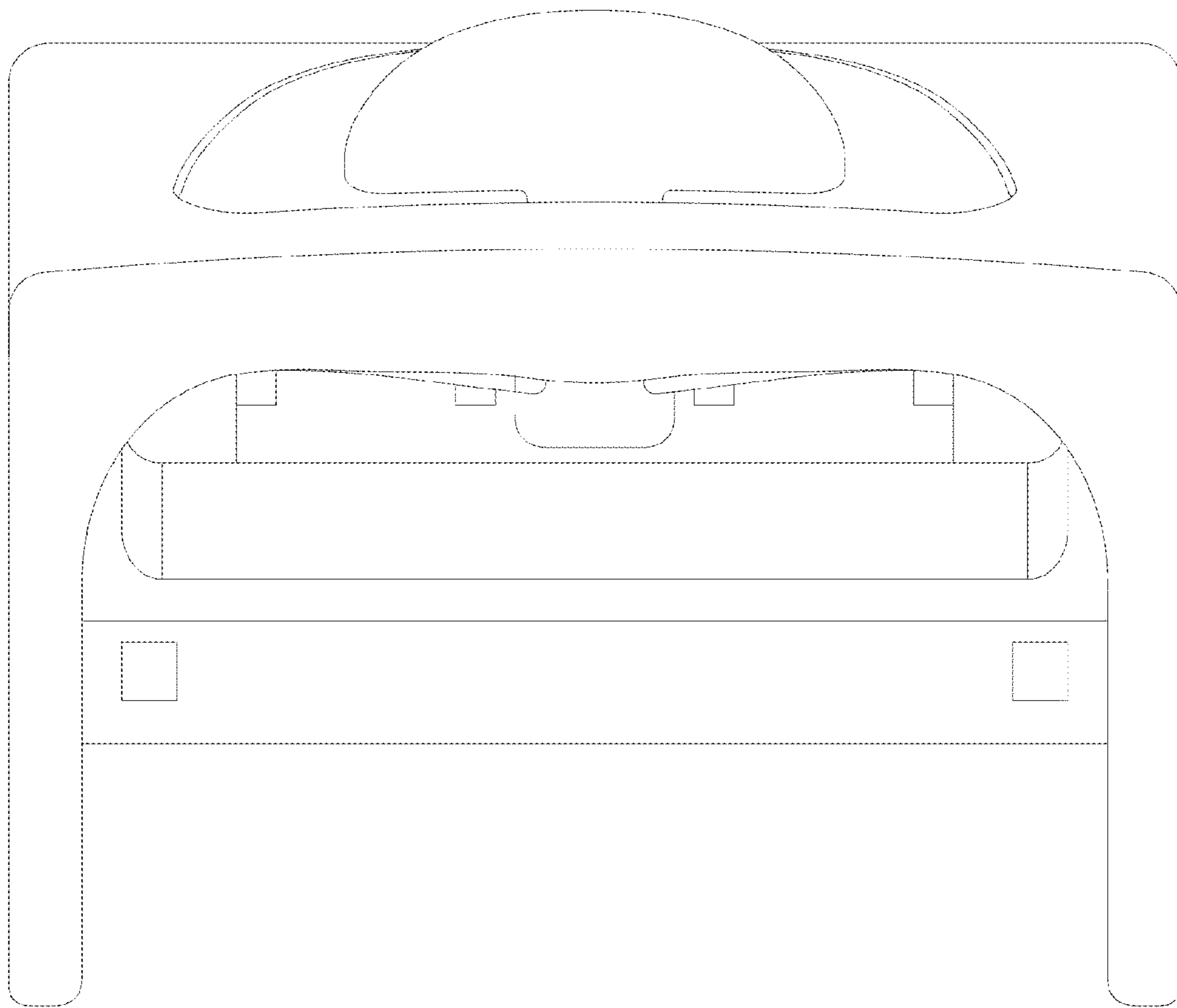

Fig. 3

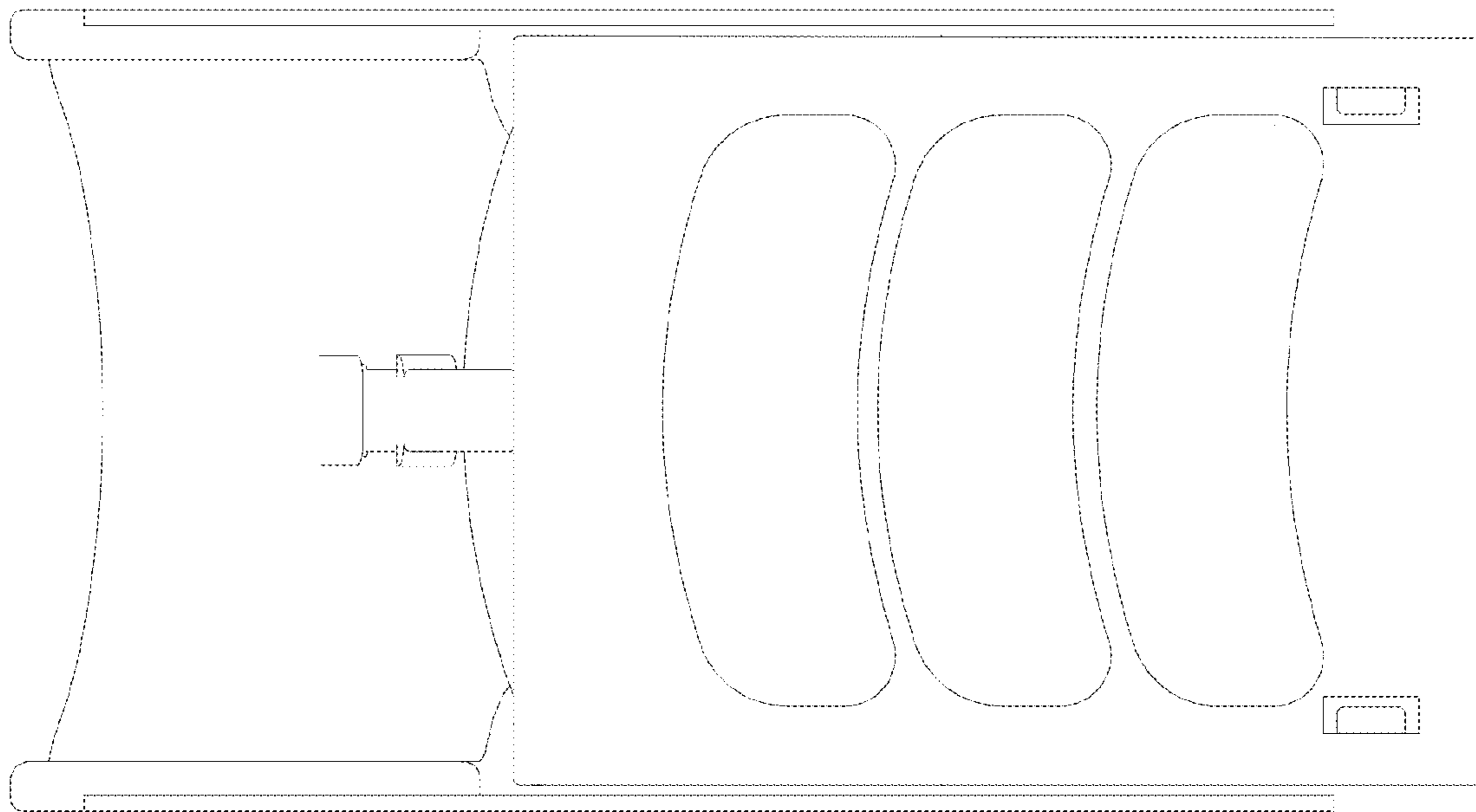

Fig. 4

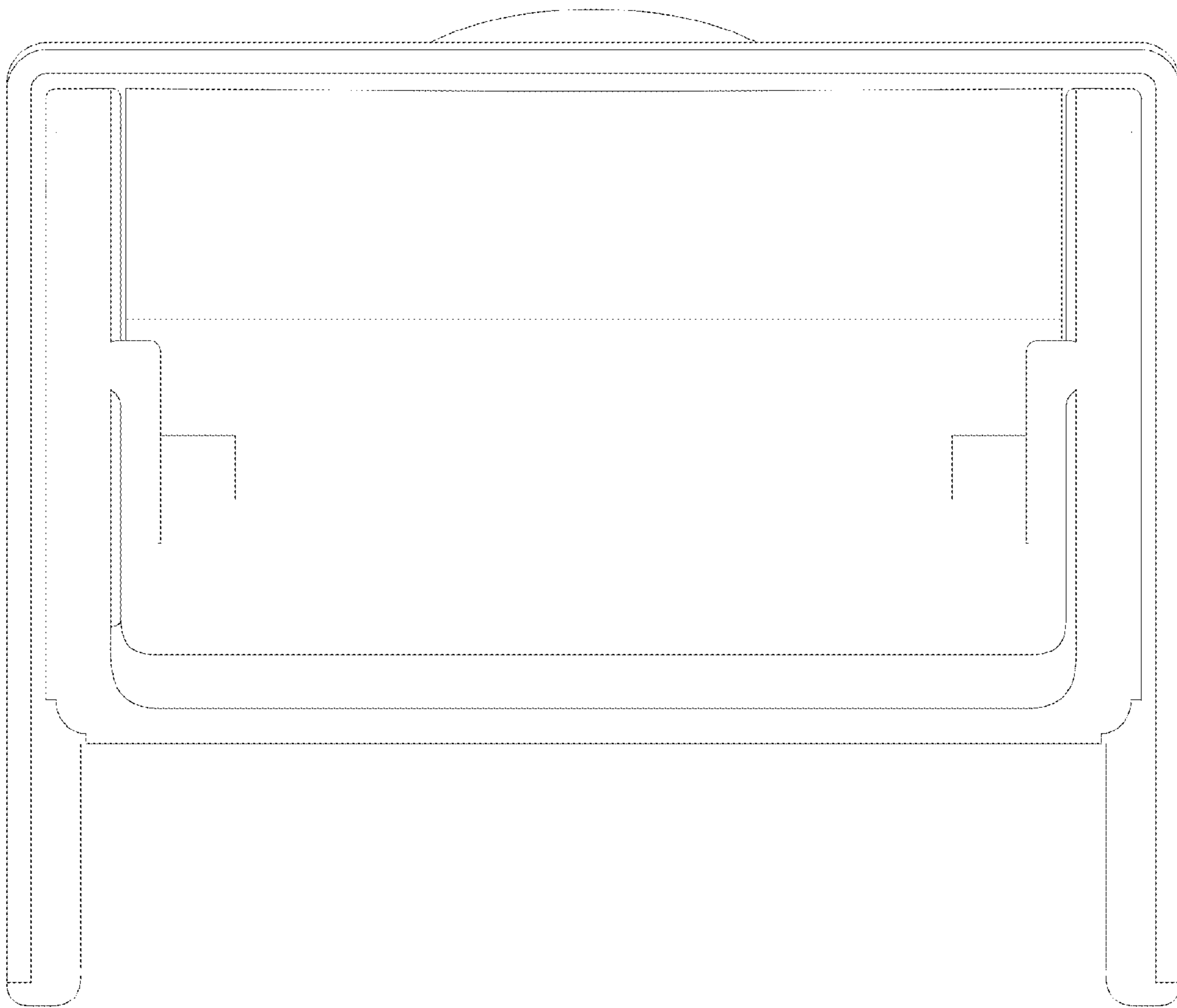

Fig. 5

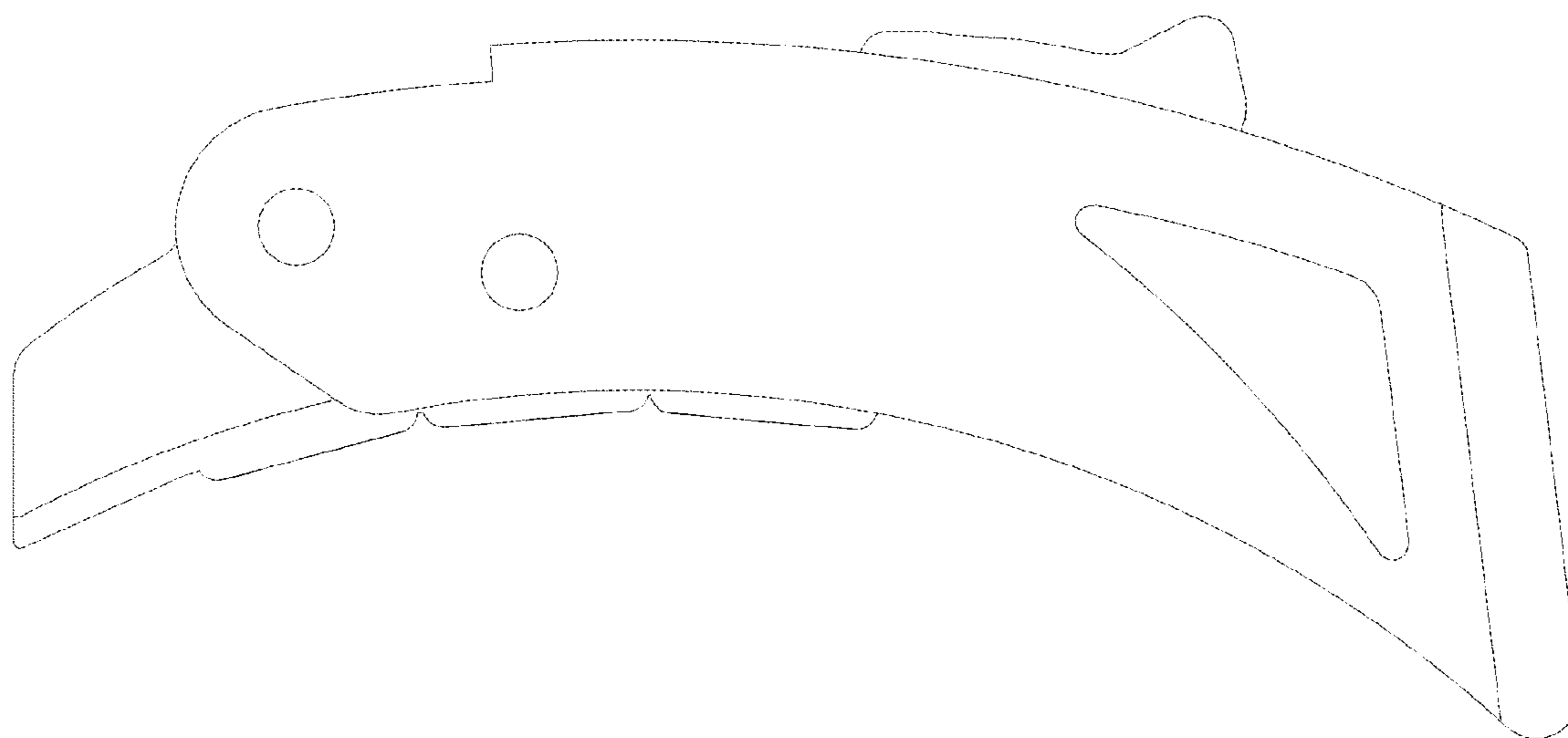

Fig. 6

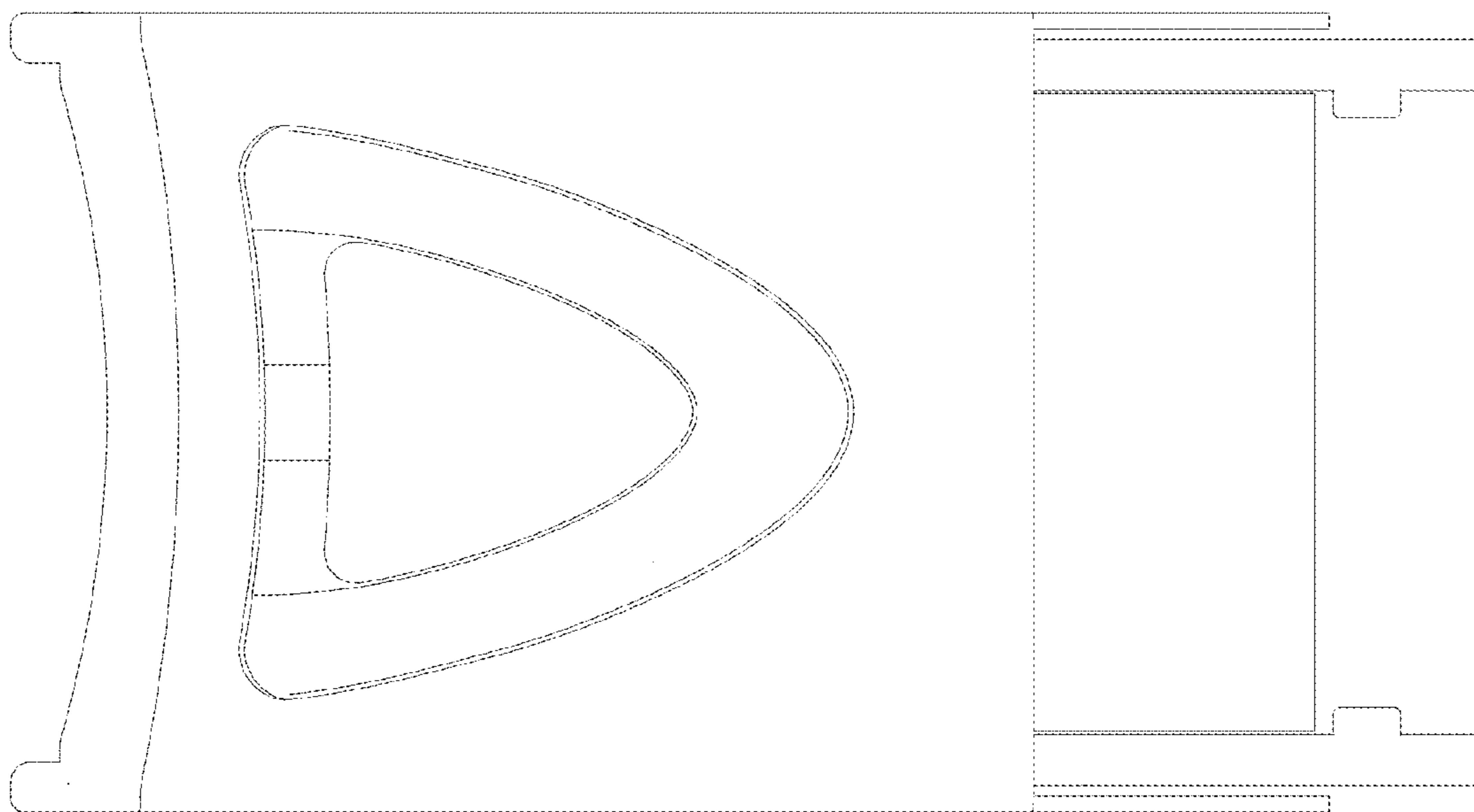

Fig. 7

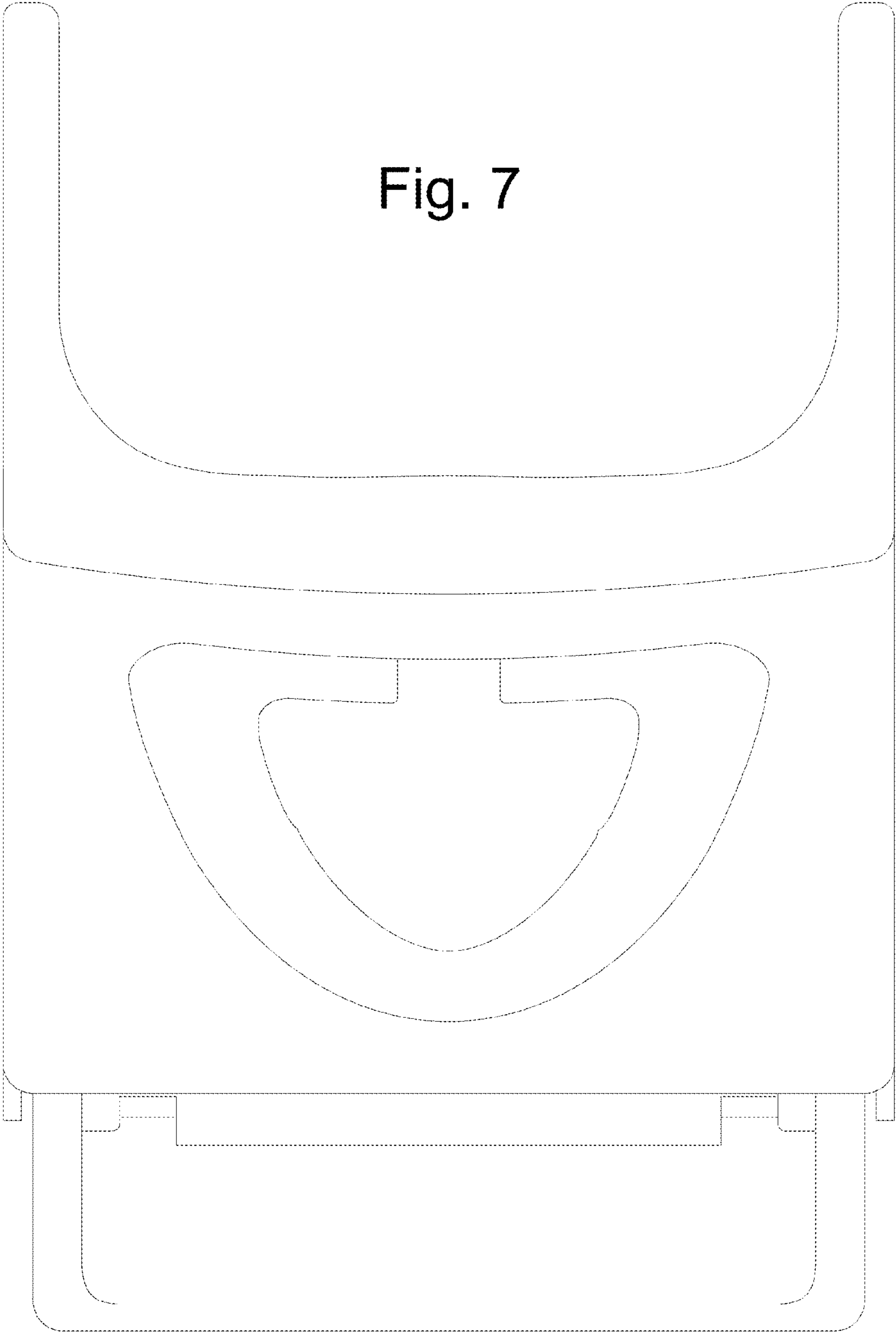

Fig. 8

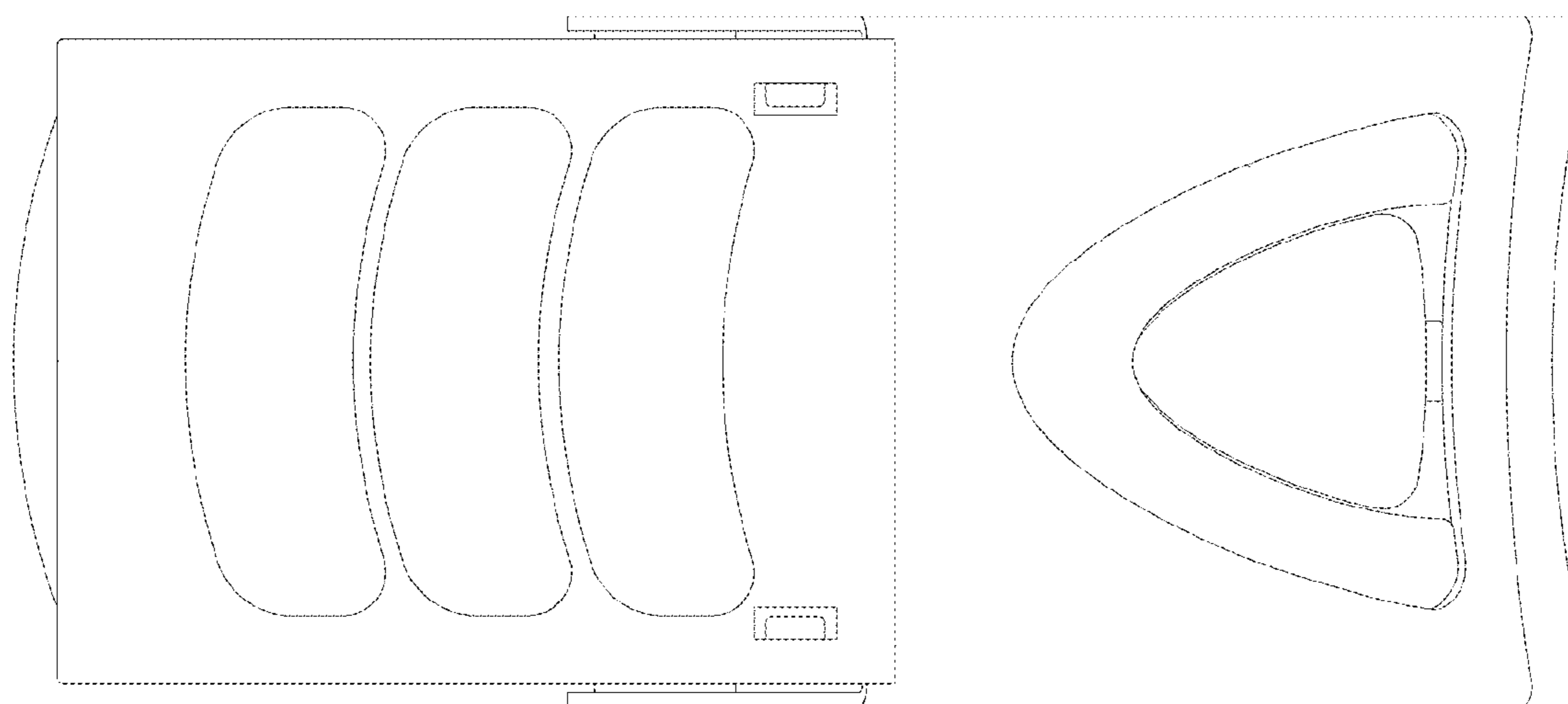

Fig. 9

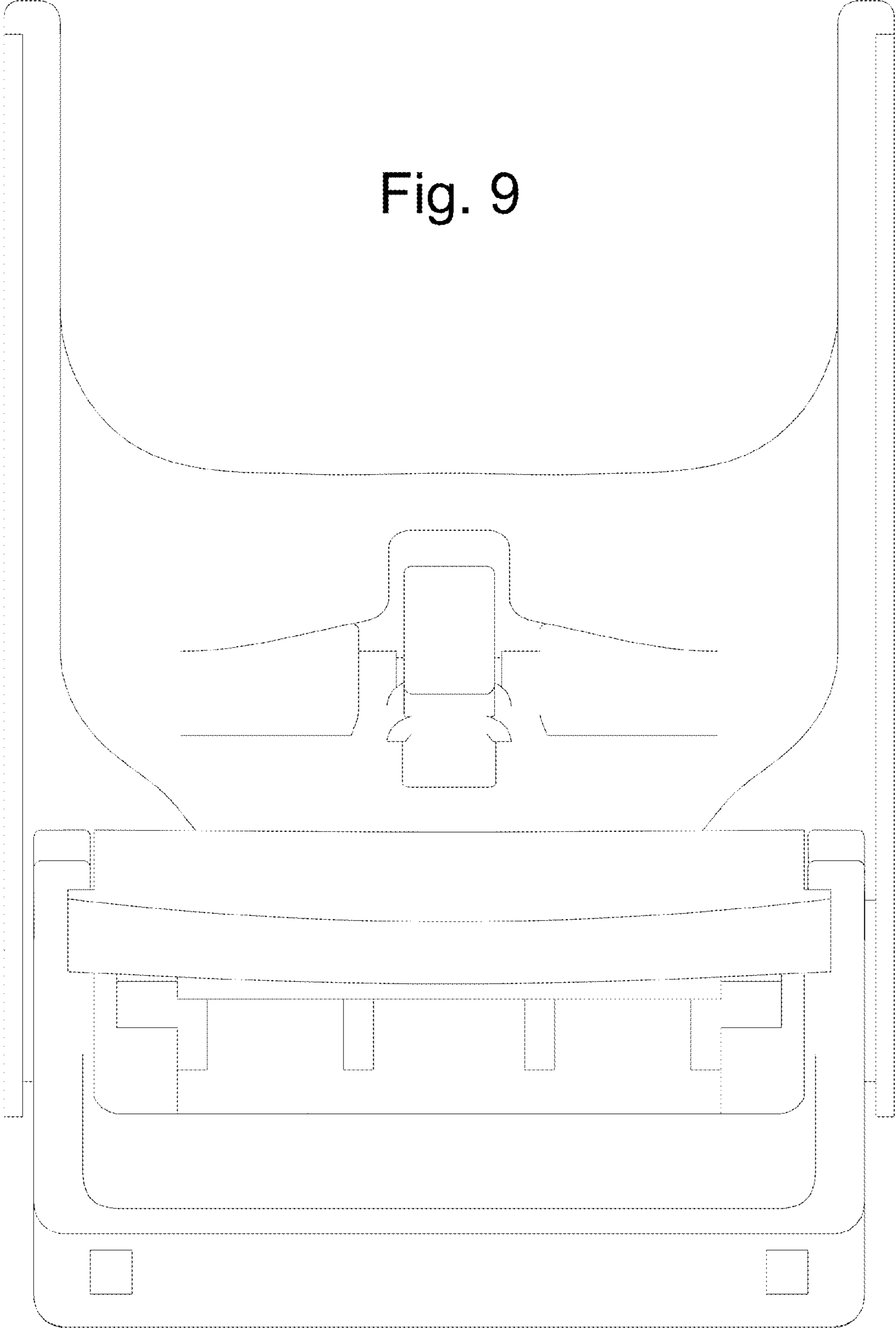

Fig. 10

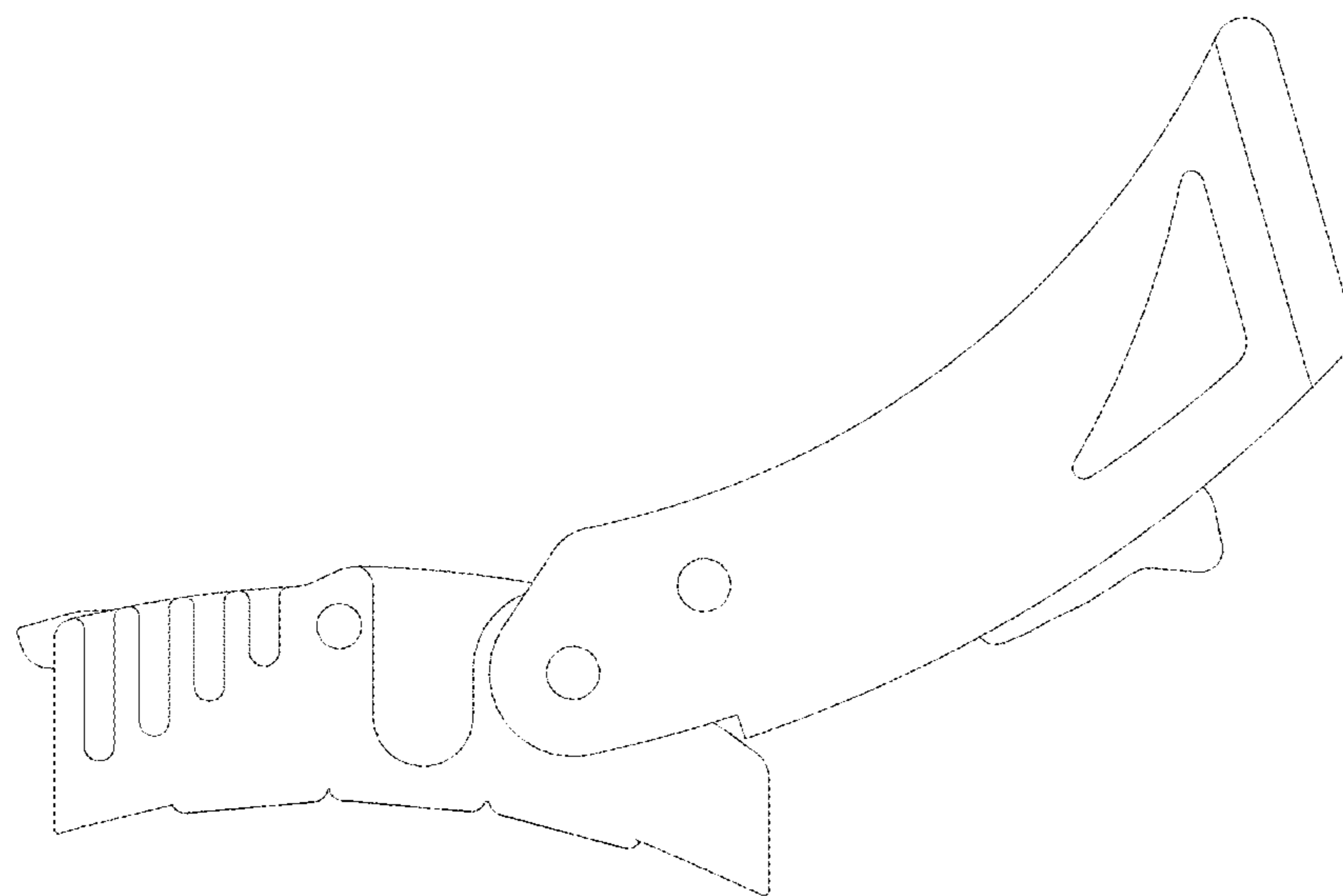

Fig. 11

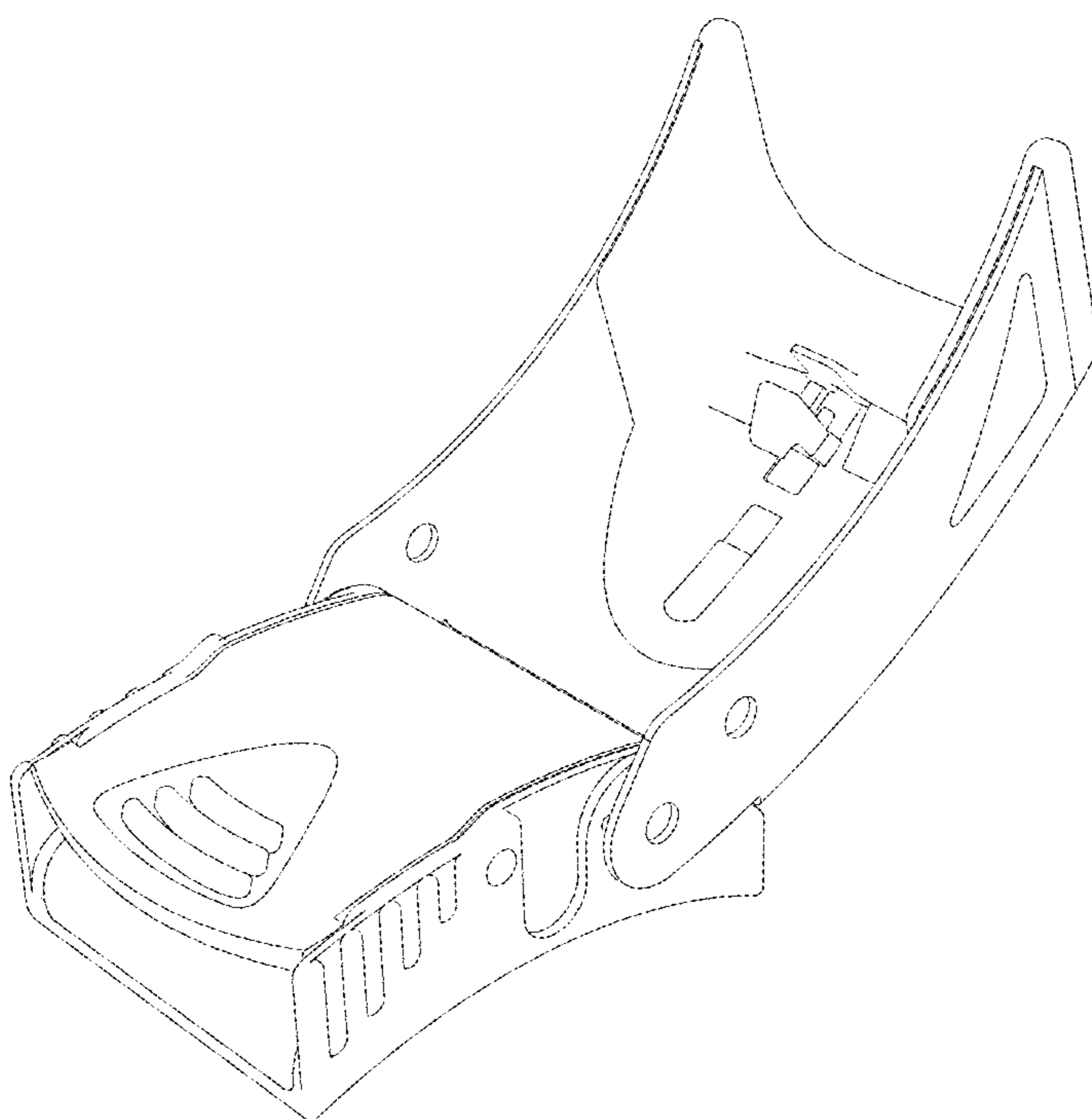

Fig. 12

