

US00D686882S

(12) **United States Design Patent**
Chiu et al.

(10) **Patent No.:** **US D686,882 S**
(45) **Date of Patent:** **** Jul. 30, 2013**

(54) **INSULATED BEVERAGE CONTAINER**
(75) Inventors: **Jeffrey Chiu**, Woodridge, IL (US);
David Starr, Woodridge, IL (US); **David Purcell**, Woodridge, IL (US); **Stephen Melamed**, Chicago, IL (US); **Luc Heiligenstein**, Chicago, IL (US)

6,053,345 A 4/2000 Jones
D424,371 S * 5/2000 Delmonte D7/607
6,059,153 A 5/2000 Olson et al.
6,119,888 A 9/2000 Goto et al.
D434,326 S 11/2000 Smorch
D434,608 S 12/2000 Hansen
6,209,781 B1 * 4/2001 Sylvester et al. 229/110
D452,798 S 1/2002 Nixon

(73) Assignee: **Wilton Industries, Inc.**, Woodridge, IL (US)

(Continued)

(**) Term: **14 Years**

OTHER PUBLICATIONS

Box O'Joe® Dunkin Donuts, 2 pages, published at least prior to Jul. 25, 2012, <http://www.dunkindonuts.com/content/dunkindonuts/en/menu/beverages/hotbeverages/cof...>

(21) Appl. No.: **29/428,057**

Primary Examiner — Terry Wallace

(22) Filed: **Jul. 25, 2012**

(74) *Attorney, Agent, or Firm* — Foley & Lardner LLP

(51) **LOC (9) Cl.** **07-01**

(52) **U.S. Cl.**
USPC **D7/605**

(57) **CLAIM**

We claim the ornamental design for a insulated beverage container, as shown and described.

(58) **Field of Classification Search**
USPC D7/601–608, 300, 312, 313; 220/915.1, 220/915.2, 592.2, 592.01, 592.03, 592.16, 220/592.17; 222/113, 129.1, 146.1, 146.6, 222/183, 185.1, 325, 469, 153.03, 105, 465.1; 229/117.27, 125.15

DESCRIPTION

See application file for complete search history.

FIG. 1 is a perspective front view of the insulated beverage container;
FIG. 2 is a first side view of the design embodiment shown in FIG. 1;
FIG. 3 is a second side view of the design embodiment shown in FIG. 1;
FIG. 4 is a third side view of the design embodiment shown in FIG. 1;
FIG. 5 is a top view of the design embodiment shown in FIG. 1; and,
FIG. 6 is a bottom view of the design embodiment shown in FIG. 1.

The ornamental design which is claimed is shown in solid lines in the drawings. The broken lines in the drawings are for illustrative purposes only and form no part of the claimed design.

(56) **References Cited**

U.S. PATENT DOCUMENTS

4,811,858 A 3/1989 Augur
4,865,208 A 9/1989 Lax et al.
4,892,207 A 1/1990 Cullis
4,969,571 A 11/1990 Bartz
5,183,169 A 2/1993 Grzych
D376,876 S 12/1996 McInnes
D378,651 S 4/1997 Marion
5,715,992 A * 2/1998 Andrews et al. 229/125.15
D394,209 S 5/1998 Millet
D406,989 S * 3/1999 Rausch D7/624.3
5,884,802 A 3/1999 Leibowitz
5,950,831 A 9/1999 Millet
D417,369 S * 12/1999 Rausch D7/624.3

1 Claim, 6 Drawing Sheets

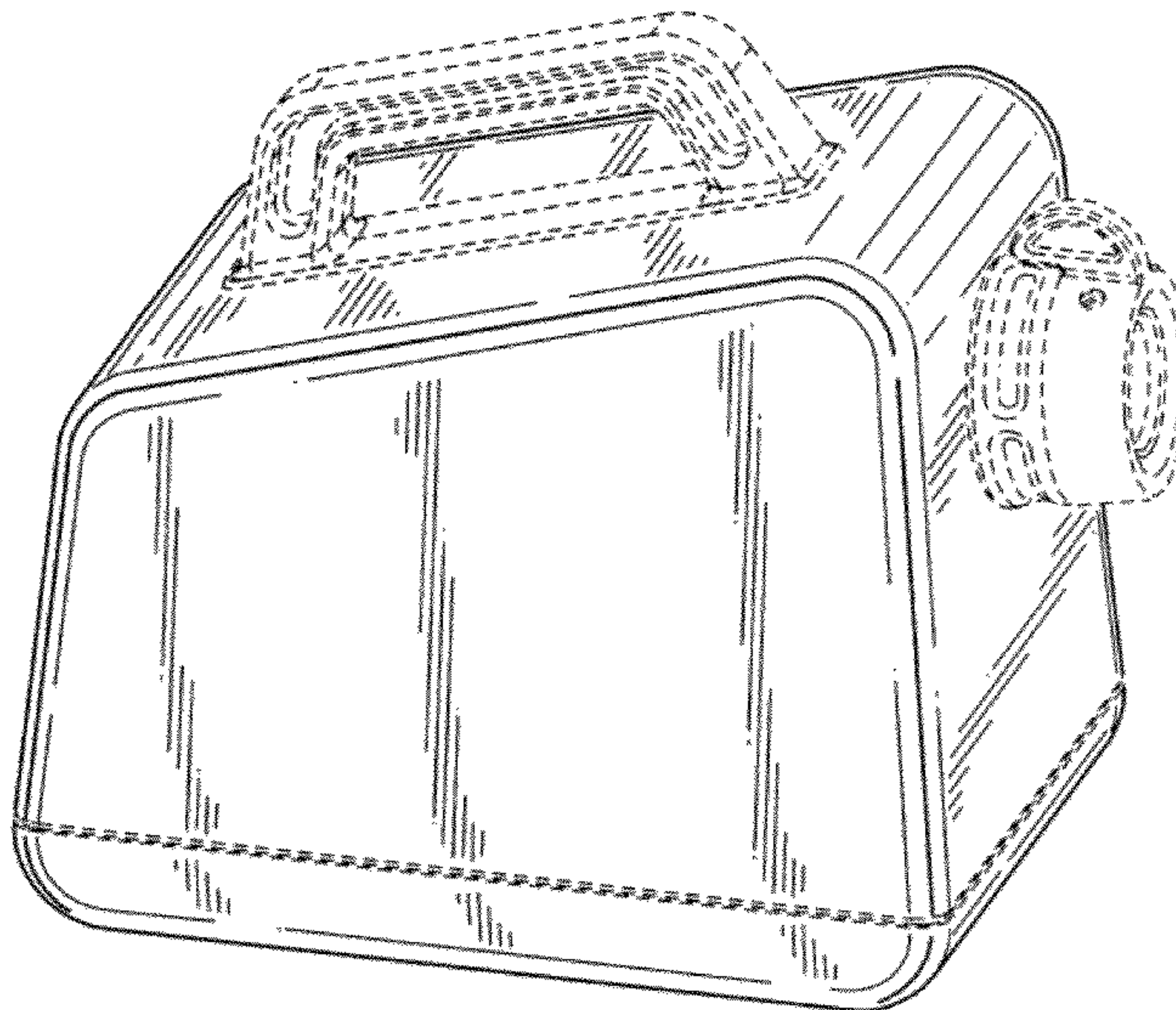

US D686,882 S

Page 2

U.S. PATENT DOCUMENTS

6,401,964 B1	6/2002	Goto et al.	D618,966 S *	7/2010	Koehler et al.	D7/607
D466,413 S	12/2002	Justice	7,770,752 B2	8/2010	Gruskin et al.	
D469,019 S	1/2003	Schlueter	D626,846 S	11/2010	Schlies	
D514,940 S	2/2006	Darr et al.	D629,694 S	12/2010	Heisner	
D522,868 S	6/2006	Bowen et al.	7,913,874 B2	3/2011	Gruskin et al.	
7,156,265 B2	1/2007	Walsh et al.	2001/0010313 A1	8/2001	Goto et al.	
7,182,214 B2	2/2007	Darr et al.	2002/0066735 A1	6/2002	Hewlitt et al.	
D541,594 S	5/2007	Fleishour	2004/0065636 A1	4/2004	Thibodeau et al.	
D547,662 S	7/2007	Hankins et al.	2006/0037929 A1	2/2006	Darr et al.	
D580,768 S	11/2008	Ferguson et al.	2007/0158300 A1	7/2007	Young et al.	
D581,277 S	11/2008	Horstman et al.	2008/0023434 A1	1/2008	Takayama	
D589,351 S	3/2009	Caldwell	2010/0059536 A1	3/2010	Stolk	
D604,623 S	11/2009	Baker, III	2010/0237086 A1	9/2010	Matsumura et al.	
7,726,500 B2	6/2010	Young et al.				

* cited by examiner

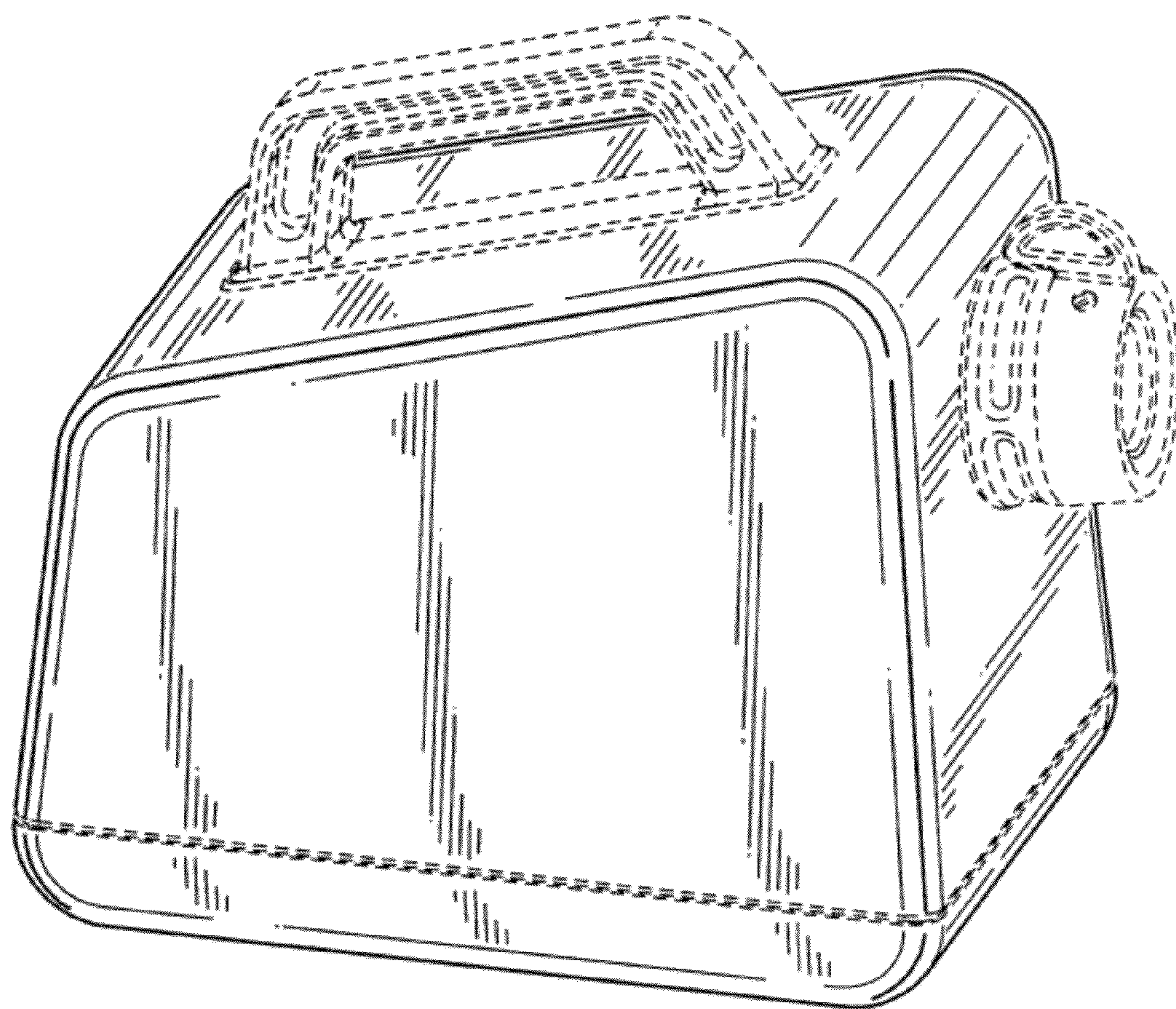

FIG. 1

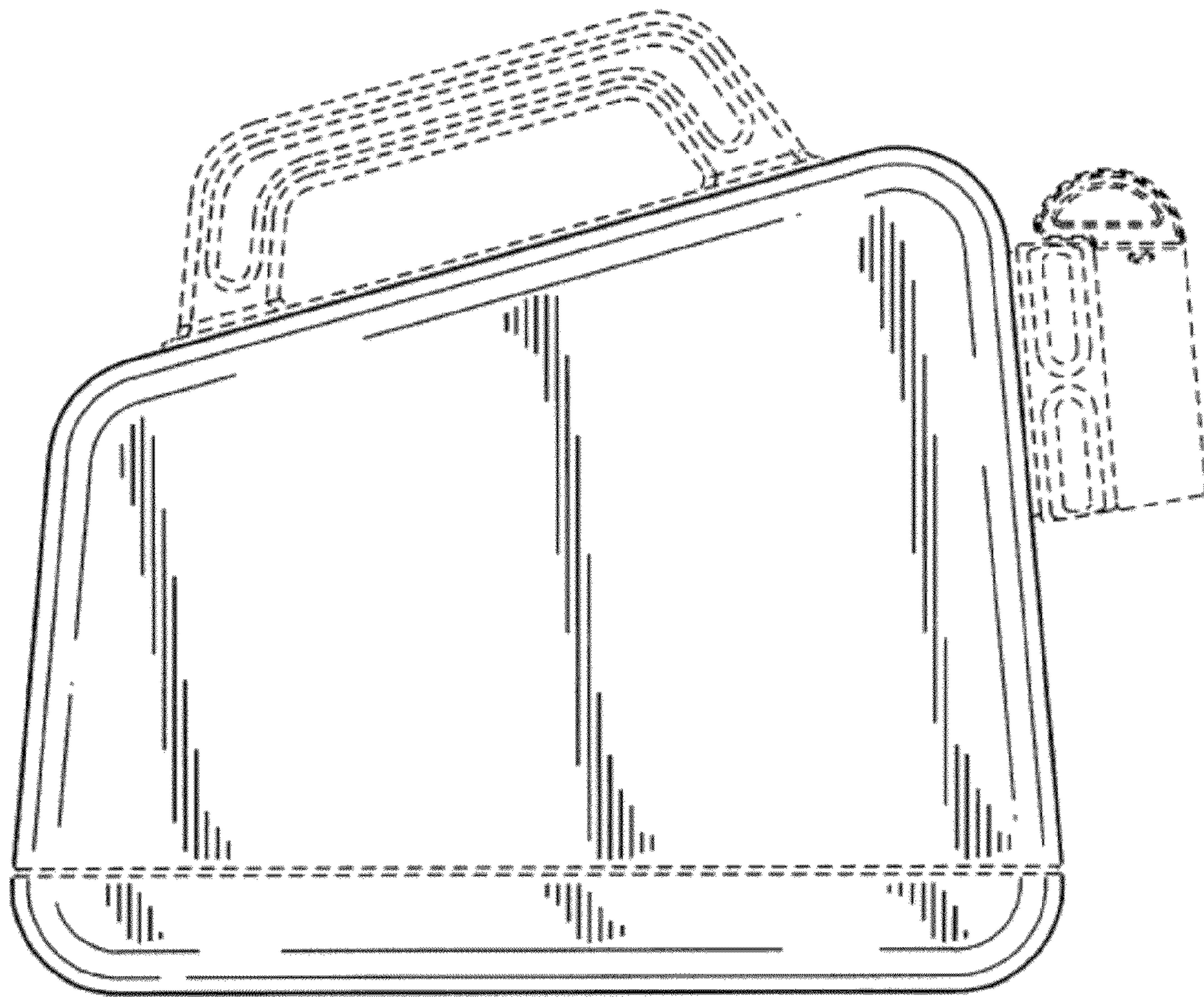

FIG. 2

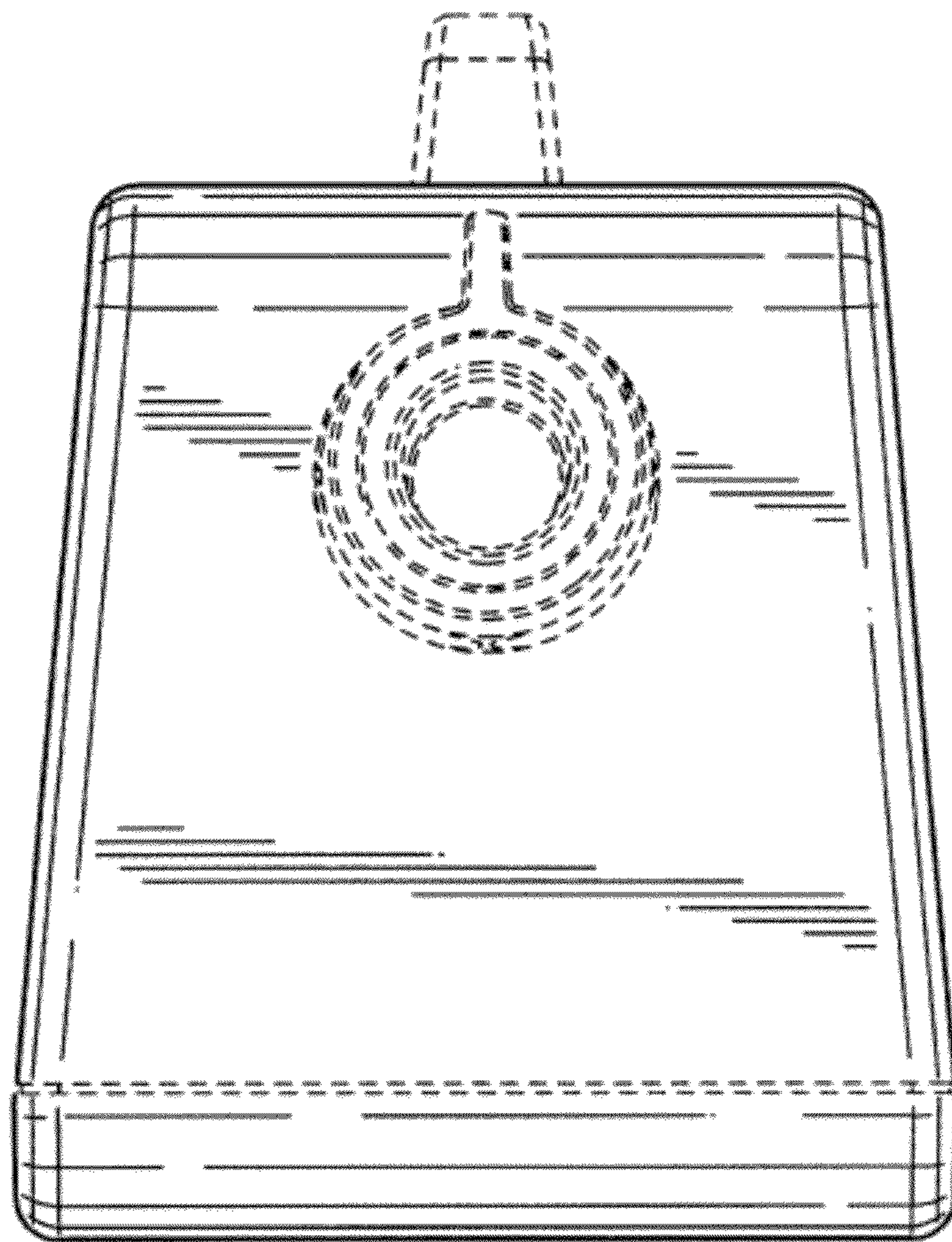

FIG. 3

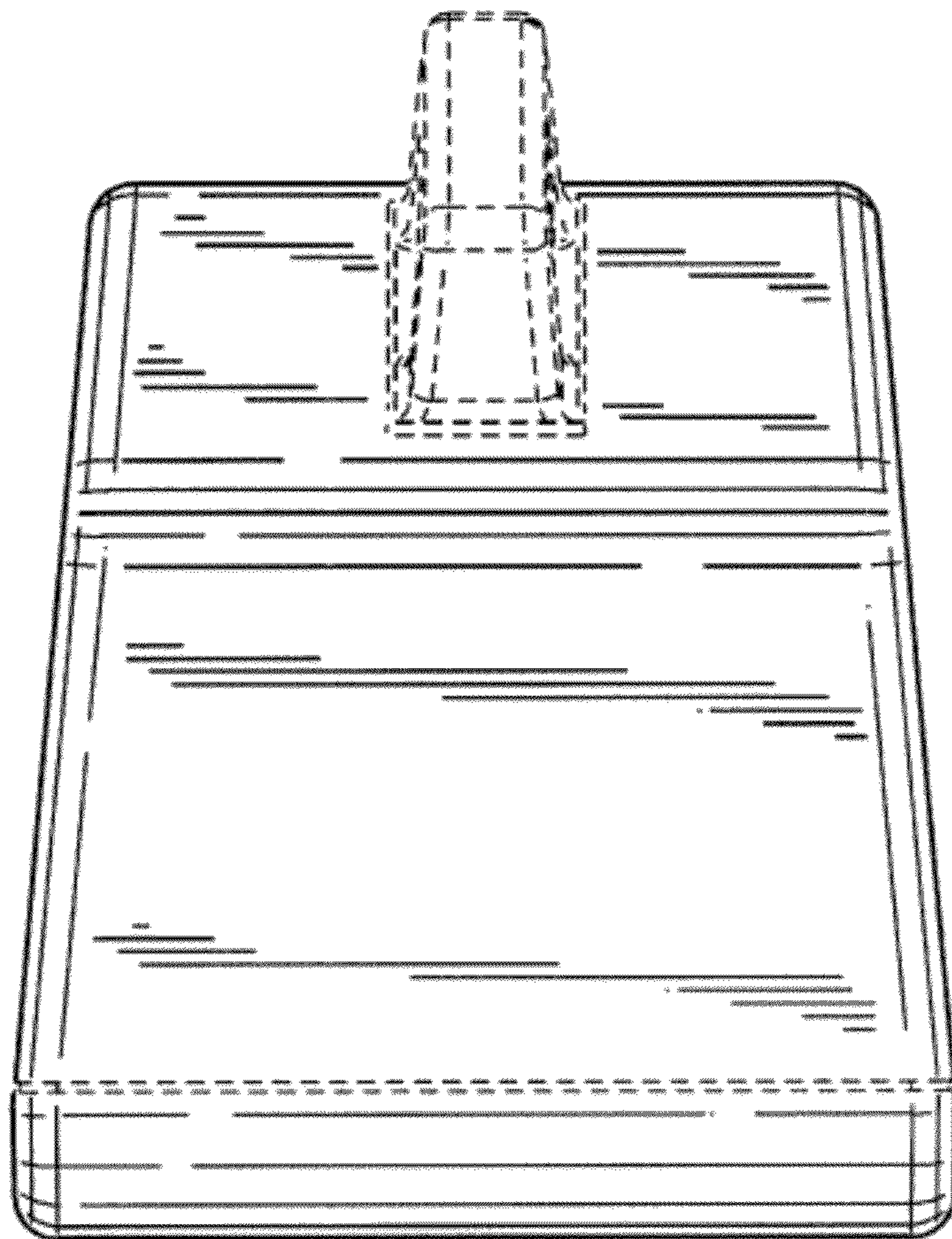

FIG. 4

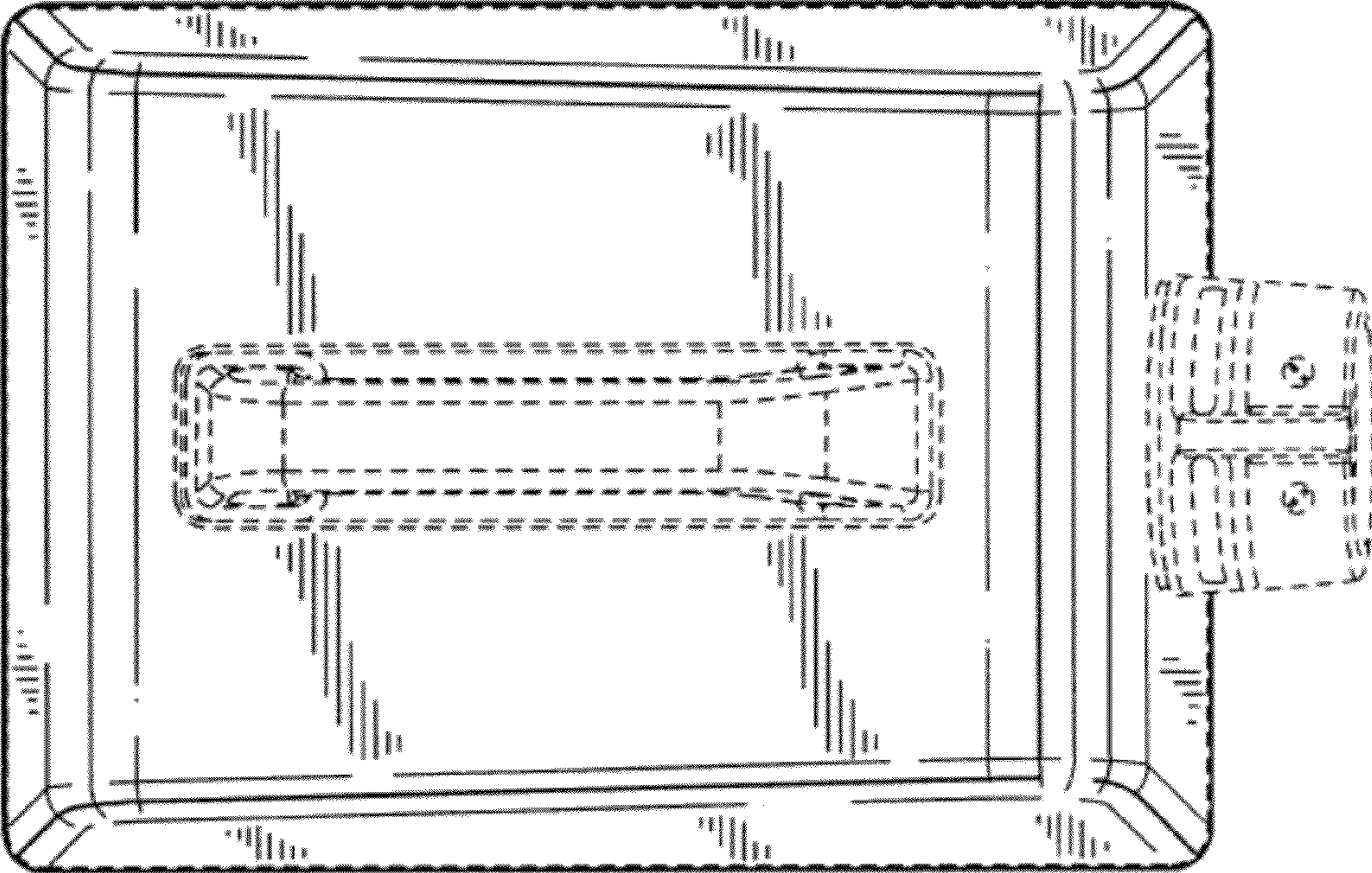

FIG. 5

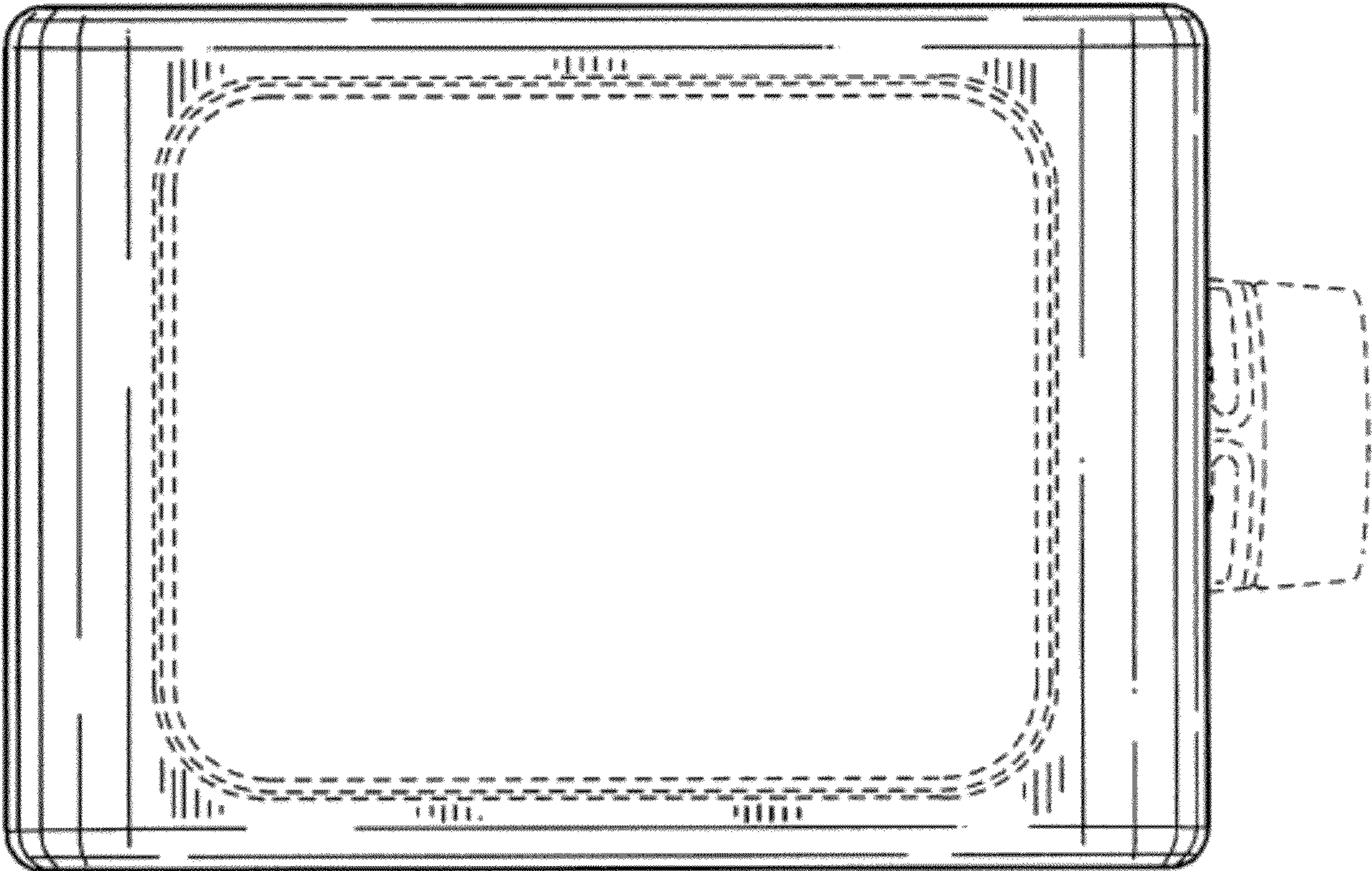

FIG. 6