



US00D686856S

(12) **United States Design Patent**
Krusin

(10) **Patent No.:** **US D686,856 S**

(45) **Date of Patent:** **** Jul. 30, 2013**

(54) **TABLE BASE**

D431,398 S * 10/2000 Luong et al. D6/484
D662,334 S * 6/2012 Schultz D6/484

(75) Inventor: **Marc Krusin**, London (GB)

* cited by examiner

(73) Assignee: **Knoll, Inc.**, East Greenville, PA (US)

Primary Examiner — Janice Seeger

(**) Term: **14 Years**

(74) *Attorney, Agent, or Firm* — Buchanan Ingersoll & Rooney PC

(21) Appl. No.: **29/423,927**

(57) **CLAIM**
The ornamental design for a table base, as shown and described.

(22) Filed: **Jun. 6, 2012**

DESCRIPTION

(51) **LOC (9) Cl.** **06-06**

(52) **U.S. Cl.**
USPC **D6/691.8**

(58) **Field of Classification Search**
USPC D6/691, 691.3, 691.8, 691.7; 108/150,
108/153.1, 156, 161, 50.01, 50.02; 248/188,
248/188.1, 188.7

FIG. 1 is a perspective view of a table base showing my new design;
FIG. 2 is a front elevational view thereof;
FIG. 3 is a rear elevational view thereof;
FIG. 4 is a top plan view thereof;
FIG. 5 is a right side elevational view thereof;
FIG. 6 is a left side elevational view thereof; and,
FIG. 7 is a perspective view to more fully illustrate the table base with a sample table top.

See application file for complete search history.

The phantom lines in FIG. 7 are for illustrative purposes only to show a sample table top and form no part of the claimed design. The phantom lines in FIGS. 1, 4 and 7 form no part of the claimed design. The bottom of the table base is not a part of the claimed design.

(56) **References Cited**

U.S. PATENT DOCUMENTS

D220,704 S * 5/1971 Kramer D6/484
D401,790 S * 12/1998 Buell D6/484

1 Claim, 5 Drawing Sheets

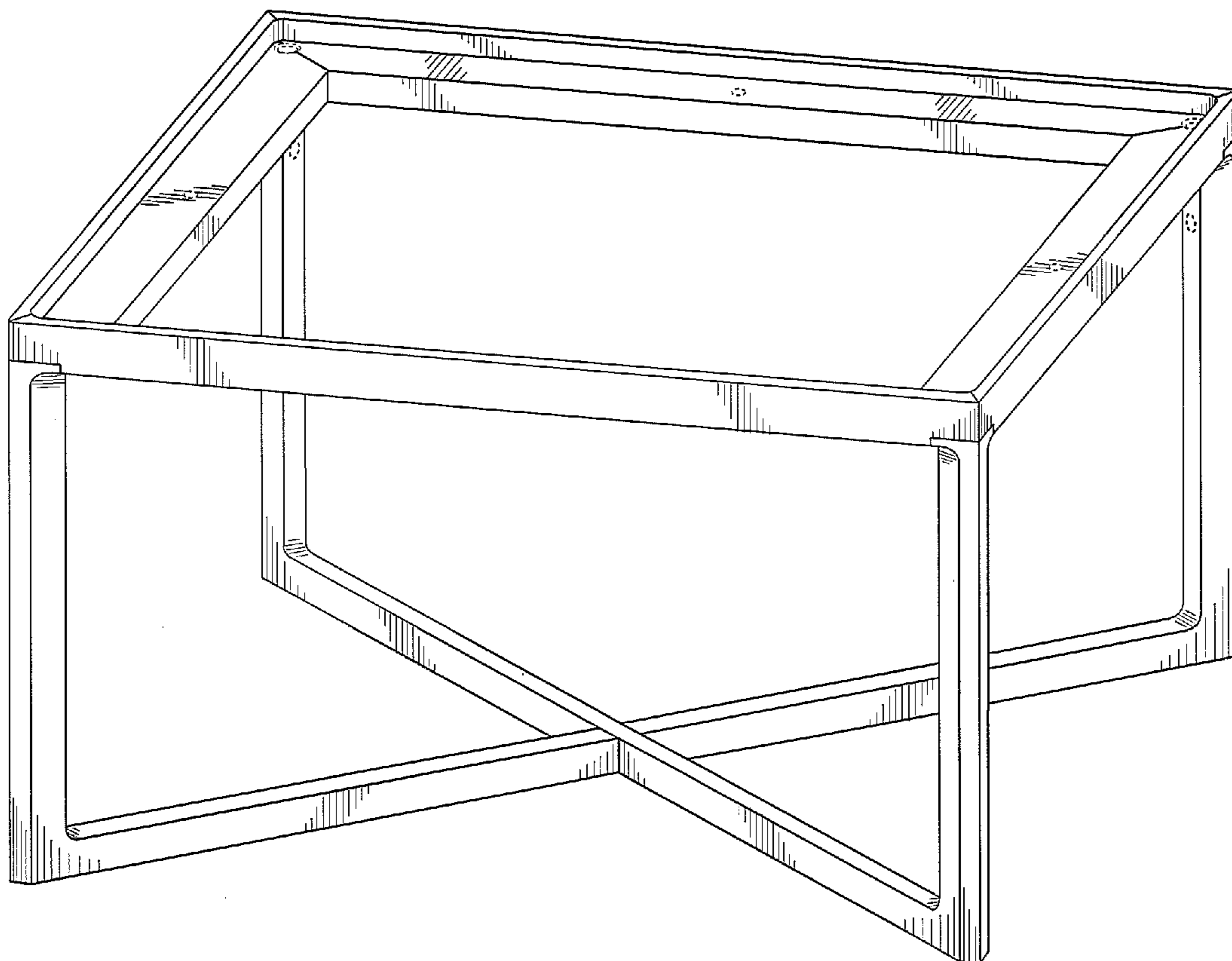

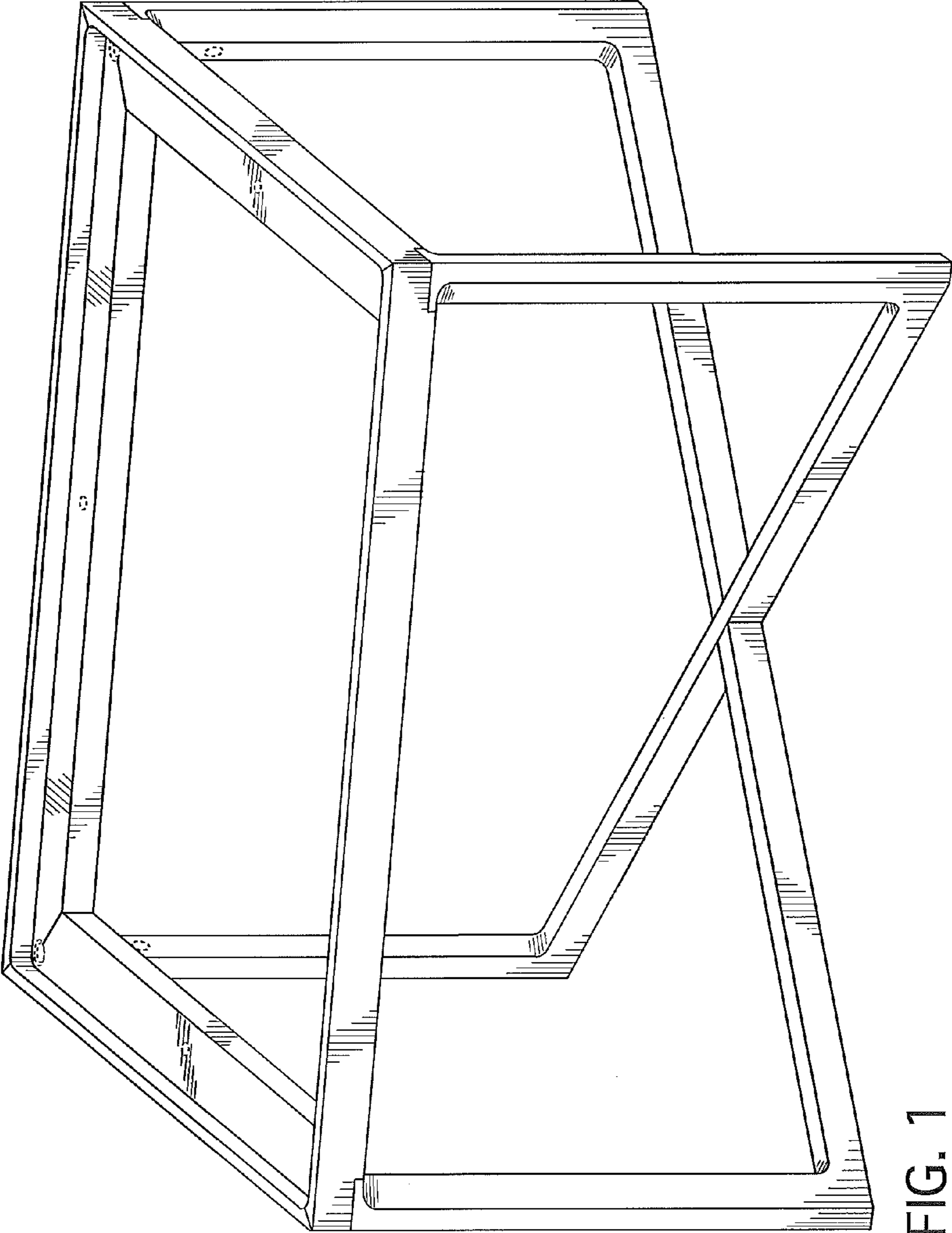

FIG. 1

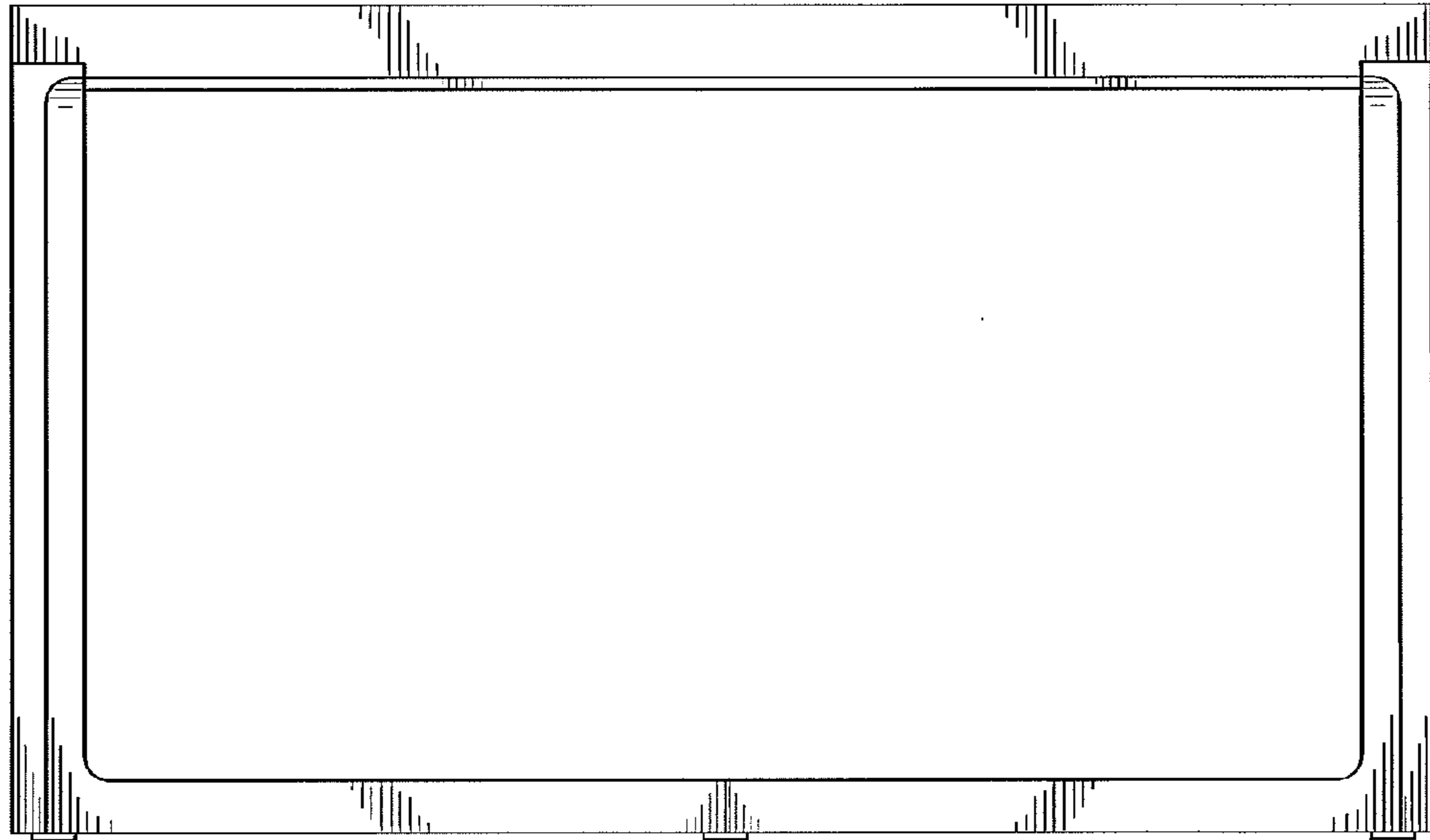

FIG. 2

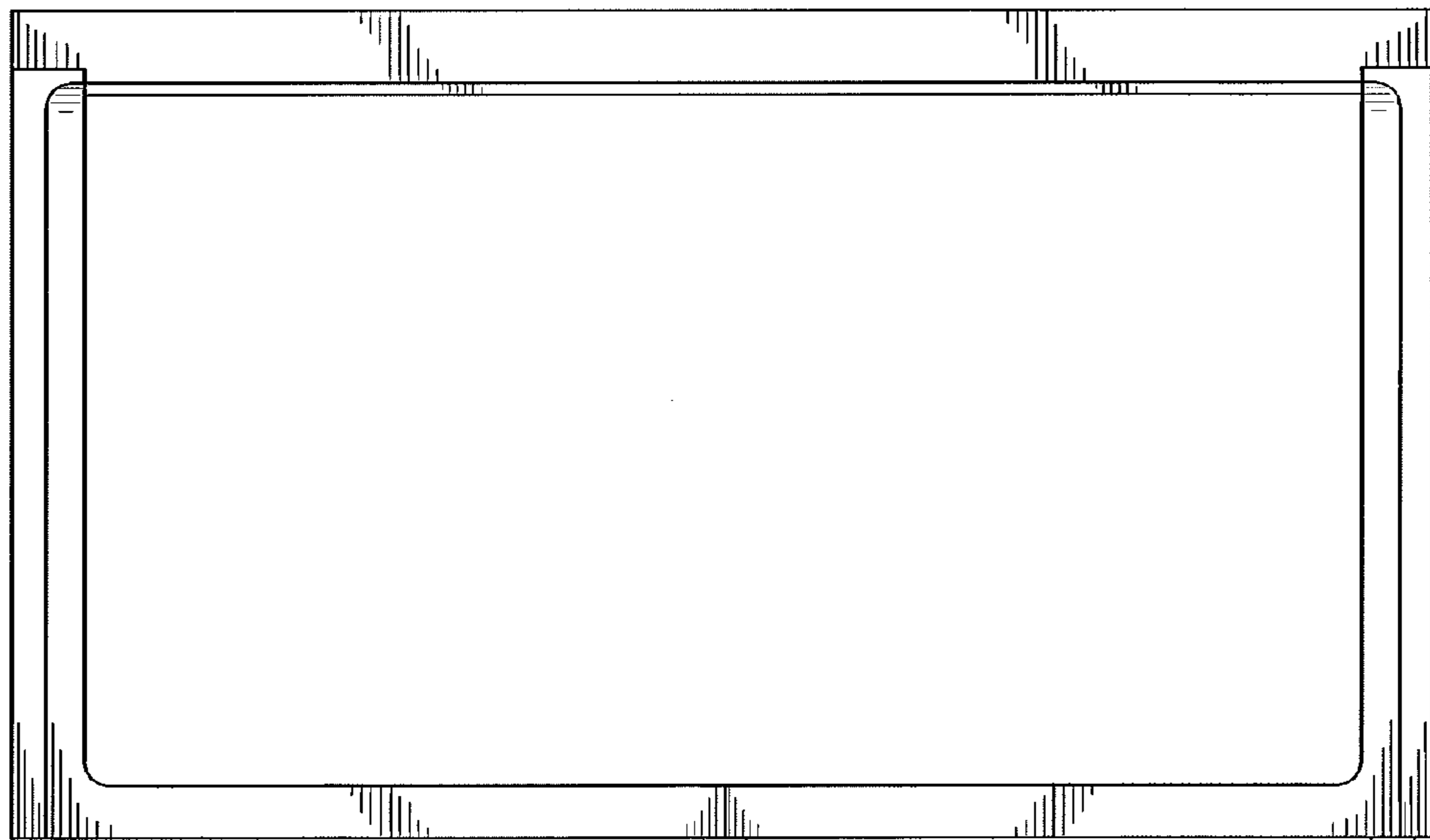

FIG. 3

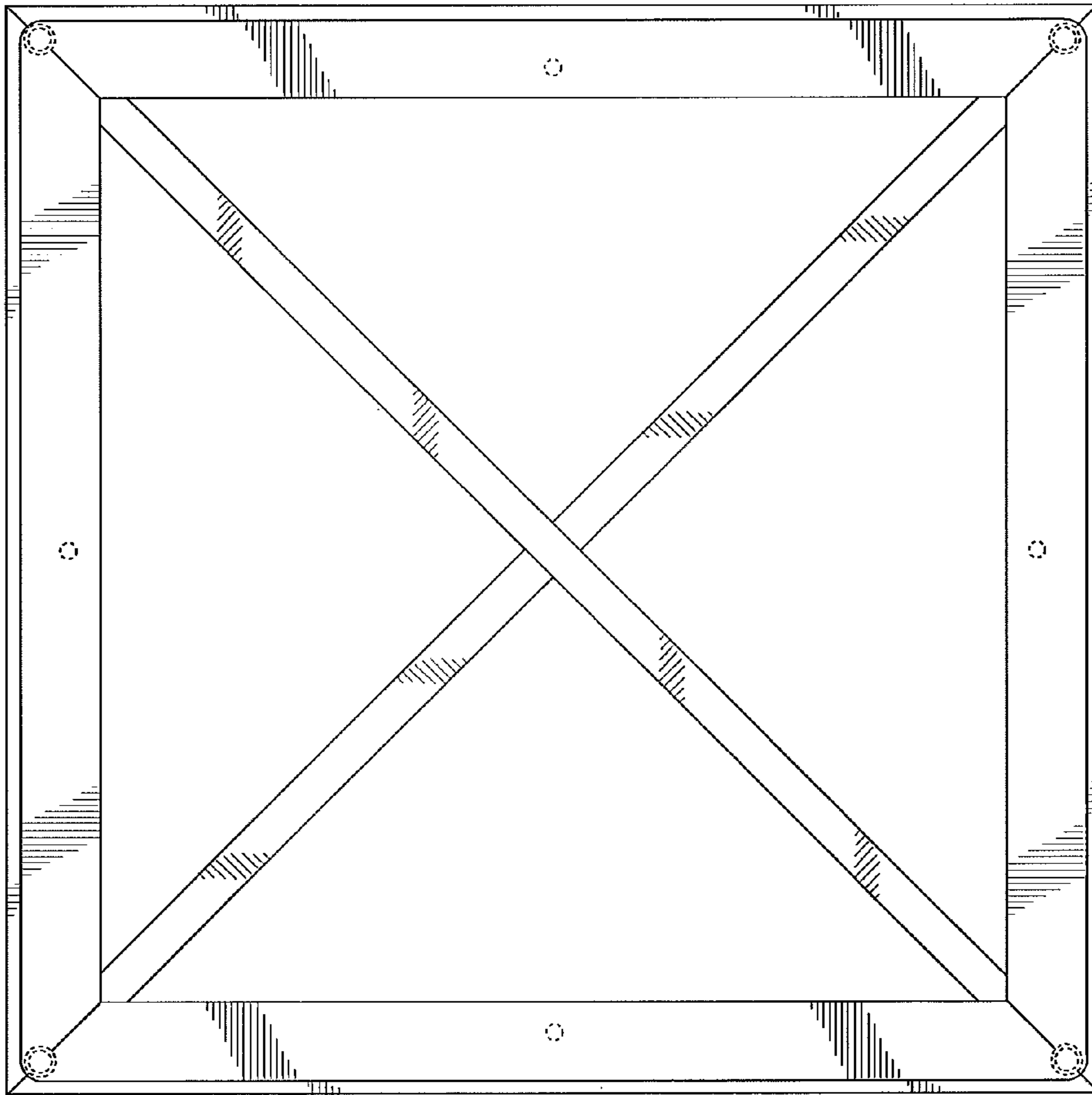

FIG. 4

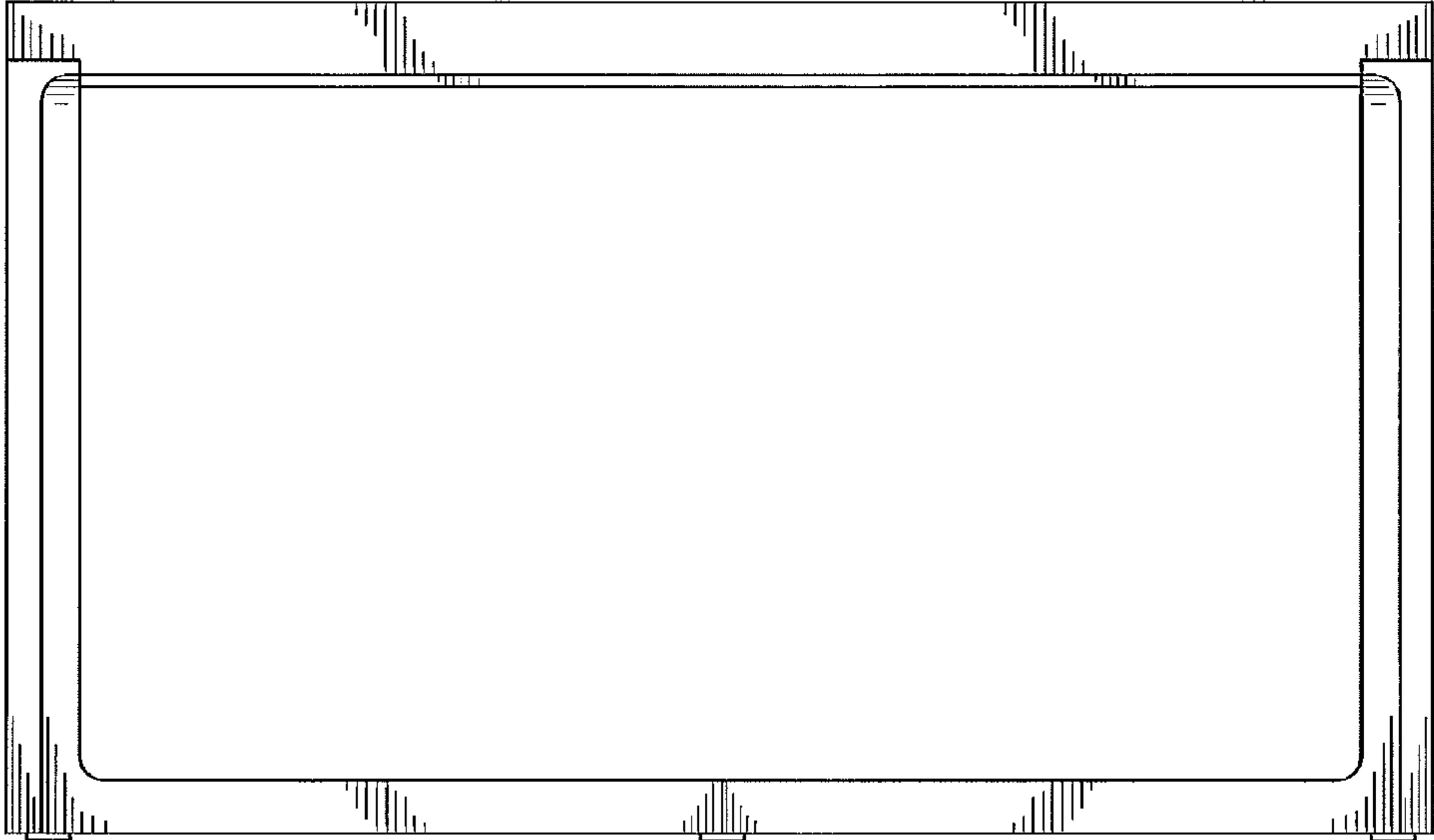

FIG. 5

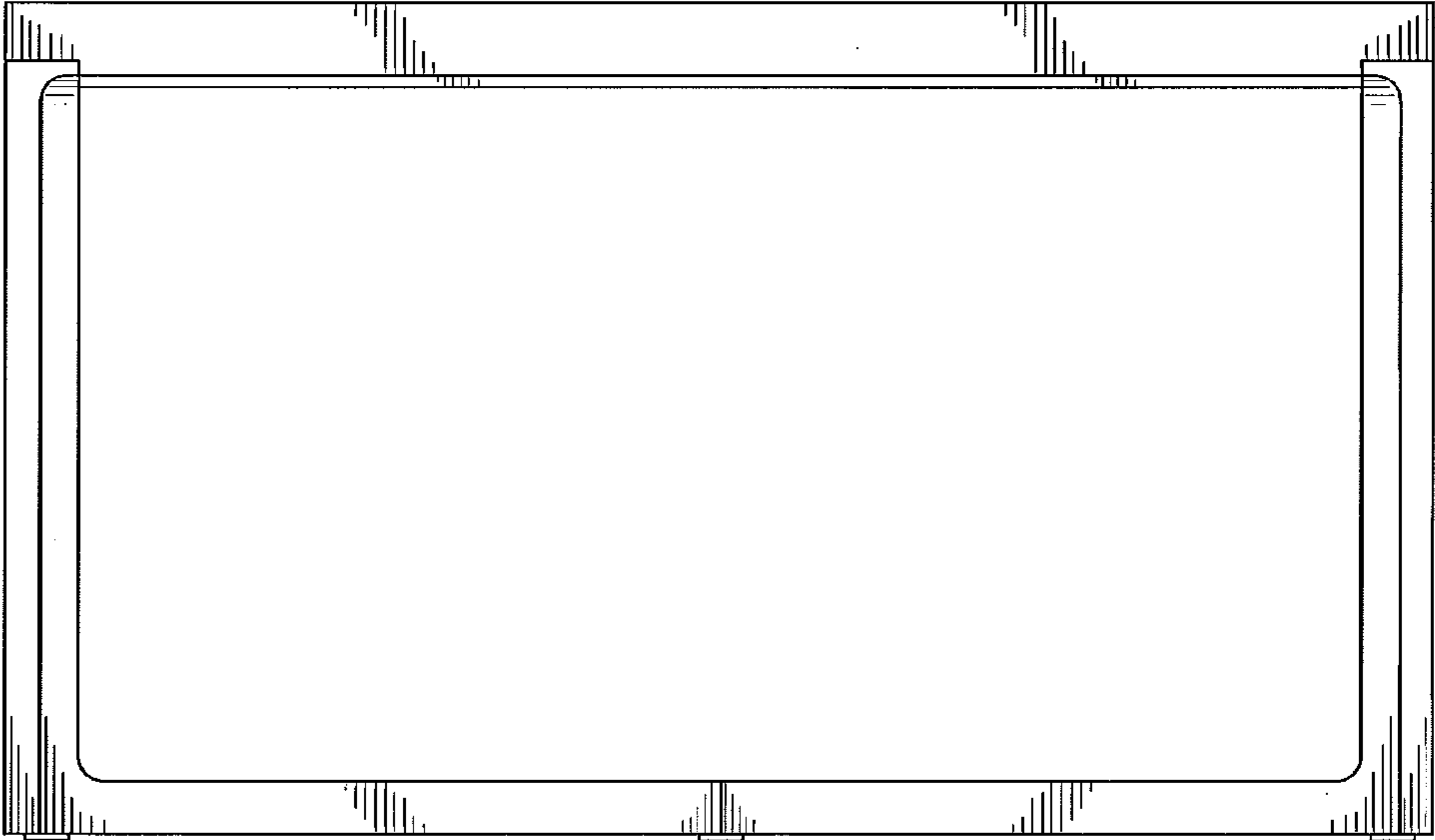

FIG. 6

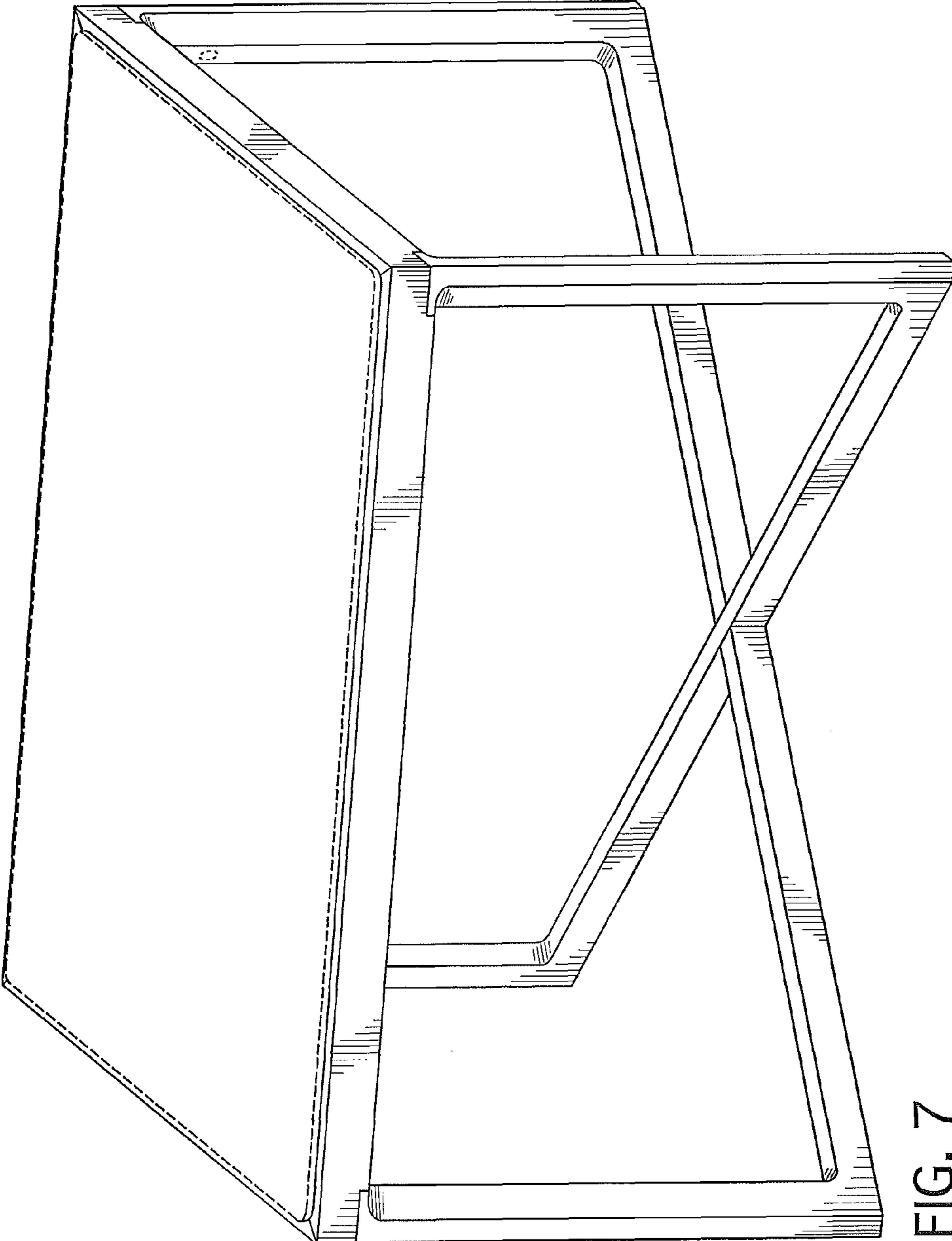

FIG. 7