



US00D686810S

(12) **United States Design Patent**  
**Weitzman**

(10) **Patent No.:** **US D686,810 S**

(45) **Date of Patent:** **\*\* Jul. 30, 2013**

(54) **FOUNDATION OF A WOMAN'S SHOE**

(71) Applicant: **Stuart Weitzman IP, LLC**, Ft. Lauderdale, FL (US)

(72) Inventor: **Stuart Weitzman**, Greenwich, CT (US)

(73) Assignee: **Stuart Weitzman IP, LLC**, Ft. Lauderdale, FL (US)

(\*\*) Term: **14 Years**

(21) Appl. No.: **29/442,023**

(22) Filed: **Oct. 26, 2012**

(51) **LOC (9) Cl.** ..... **02-04**

(52) **U.S. Cl.**  
USPC ..... **D2/950; D2/947**

(58) **Field of Classification Search**  
USPC ..... D2/902, 906, 908, 916, 918, 925,  
D2/946-962, 977; 36/3 B, 22 R, 24.5, 25 R,  
36/28, 32 R, 34 R, 59 C, 67 A, 103  
See application file for complete search history.

(56) **References Cited**

**U.S. PATENT DOCUMENTS**

413,693 A \* 10/1889 Walker ..... 36/28  
D112,076 S \* 11/1938 Levin ..... D2/950

(Continued)

**FOREIGN PATENT DOCUMENTS**

CA 24532 1/1962  
CZ 21786 5/1991

(Continued)

*Primary Examiner* — T. Chase Nelson

(74) *Attorney, Agent, or Firm* — Gottlieb, Rackman & Reisman, PC

(57) **CLAIM**

The ornamental design for the foundation of a woman's shoe, as shown and described.

**DESCRIPTION**

FIG. 1 is a top left frontal perspective view of a foundation of a woman's shoe showing my design;

FIG. 2 is a top plan view of the foundation of a woman's shoe thereof;

FIG. 3 is a left side view thereof;

FIG. 4 is a front plan view thereof;

FIG. 5 is a right side view thereof; and

FIG. 6 is a back view thereof;

FIG. 7 is a bottom plan view thereof.

FIG. 8 is a top left frontal perspective view of the second embodiment of the foundation of a woman's shoe;

FIG. 9 is a top plan view of the second embodiment thereof;

FIG. 10 is a left side view of the second embodiment thereof;

FIG. 11 is a front plan view of the second embodiment thereof;

FIG. 12 is a right side view of the second embodiment thereof; and

FIG. 13 is a back view of the second embodiment thereof;

FIG. 14 is a bottom plan view of the second embodiment thereof.

FIG. 15 is a top left frontal perspective view of the third embodiment;

FIG. 16 is a top plan view of the third embodiment thereof;

FIG. 17 is a left side view of the third embodiment thereof;

FIG. 18 is a front plan view of the third embodiment thereof;

FIG. 19 is a right side view of the third embodiment thereof; and

FIG. 20 is a back view of the third embodiment thereof; and,

FIG. 21 is a bottom plan view of the third embodiment thereof.

Any broken lines in the figures are for purposes of illustrating portions of the foundation of a woman's shoe that form no part of the claimed design.

**1 Claim, 21 Drawing Sheets**

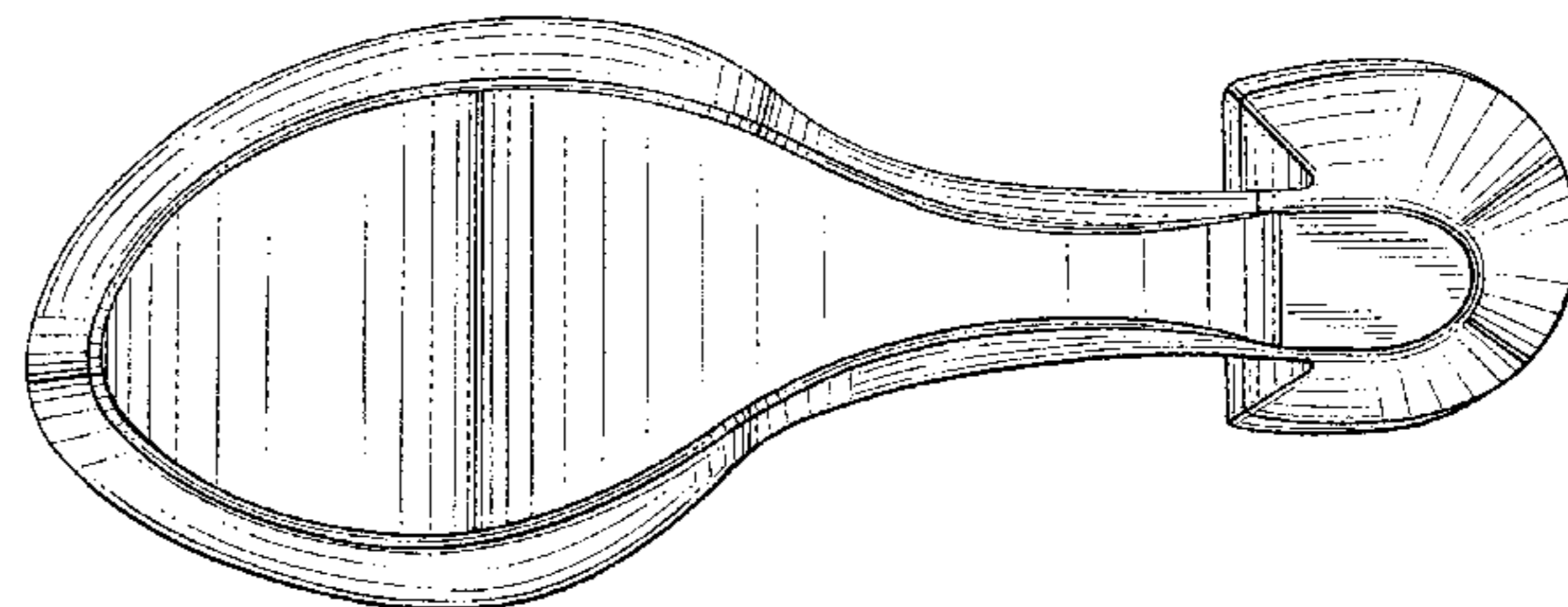
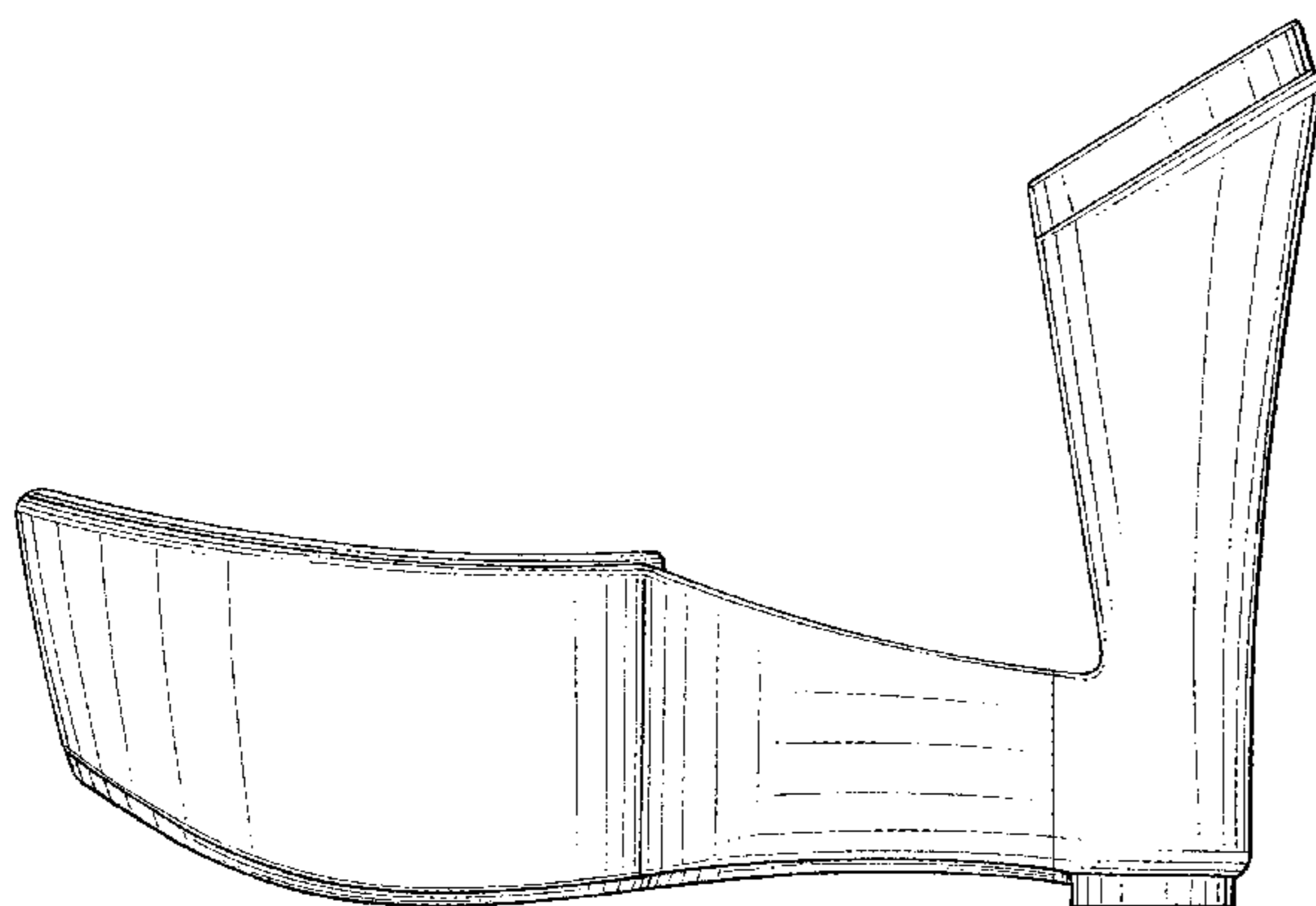

# US D686,810 S

Page 2

## U.S. PATENT DOCUMENTS

D119,397 S 12/1939 Perugia  
D119,326 S 1/1940 Fein et al.  
D120,313 S 3/1940 Hubbard  
D120,248 S \* 4/1940 Sbicca ..... D2/950  
D120,314 S \* 4/1940 Levin ..... D2/965  
D121,193 S \* 6/1940 Nutt ..... D2/965  
D121,467 S 6/1940 Calderazzo  
D123,241 S 9/1940 Johnson  
D124,896 S 1/1941 Fein  
2,258,322 A \* 10/1941 Frolich ..... 36/7.7  
2,382,559 A \* 8/1945 Goldstein ..... 36/3 A  
2,386,269 A \* 10/1945 Ryan ..... 36/59 B  
2,412,808 A \* 12/1946 Goldstein ..... 36/11.5  
2,424,609 A \* 7/1947 Friedmann, Jr. .... 36/91  
D205,882 S \* 10/1966 Post ..... D2/939  
D205,883 S \* 10/1966 Post ..... D2/939  
D247,074 S \* 1/1978 Henry ..... D2/947  
D252,836 S \* 9/1979 Picker ..... D2/950  
D261,946 S \* 11/1981 Trask ..... D2/950  
D263,094 S 2/1982 Mazabras  
D268,376 S 3/1983 Scharf  
D268,966 S \* 5/1983 Smith ..... D2/916  
D307,608 S \* 5/1990 Shure ..... D21/413  
5,435,079 A \* 7/1995 Gallegos ..... 36/38  
5,765,295 A \* 6/1998 Srourian et al. .... 36/24.5  
D415,338 S 10/1999 Phillips  
D566,959 S 4/2008 Lamont

D568,592 S 5/2008 Choi  
D572,896 S 7/2008 Choi  
D644,825 S \* 9/2011 Kotoyan ..... D2/950  
D648,931 S \* 11/2011 Weitzman ..... D2/929  
D661,070 S \* 6/2012 Della Valle et al. .... D2/935  
D666,793 S \* 9/2012 Weitzman ..... D2/933  
D675,813 S \* 2/2013 Hayashi ..... D2/950  
2002/0133977 A1 \* 9/2002 Pan ..... 36/28  
2005/0138843 A1 \* 6/2005 Hayes ..... 36/27  
2006/0218820 A1 \* 10/2006 Baden et al. .... 36/34 R

## FOREIGN PATENT DOCUMENTS

EM 000755624-0152 7/2007  
EM 000755624-0153 7/2007  
ES D0513434-17 10/2011  
FR 964850 1/1997  
FR 974544 11/1997  
FR 042861 12/2004  
FR 053476 1/2006  
FR 074412 12/2008  
FR 090355 1/2009  
FR 20105183 12/2010  
FR 20102537 4/2011  
FR 20110952 5/2012  
GB 4008879 11/2008  
GR 9109 1/2011

\* cited by examiner

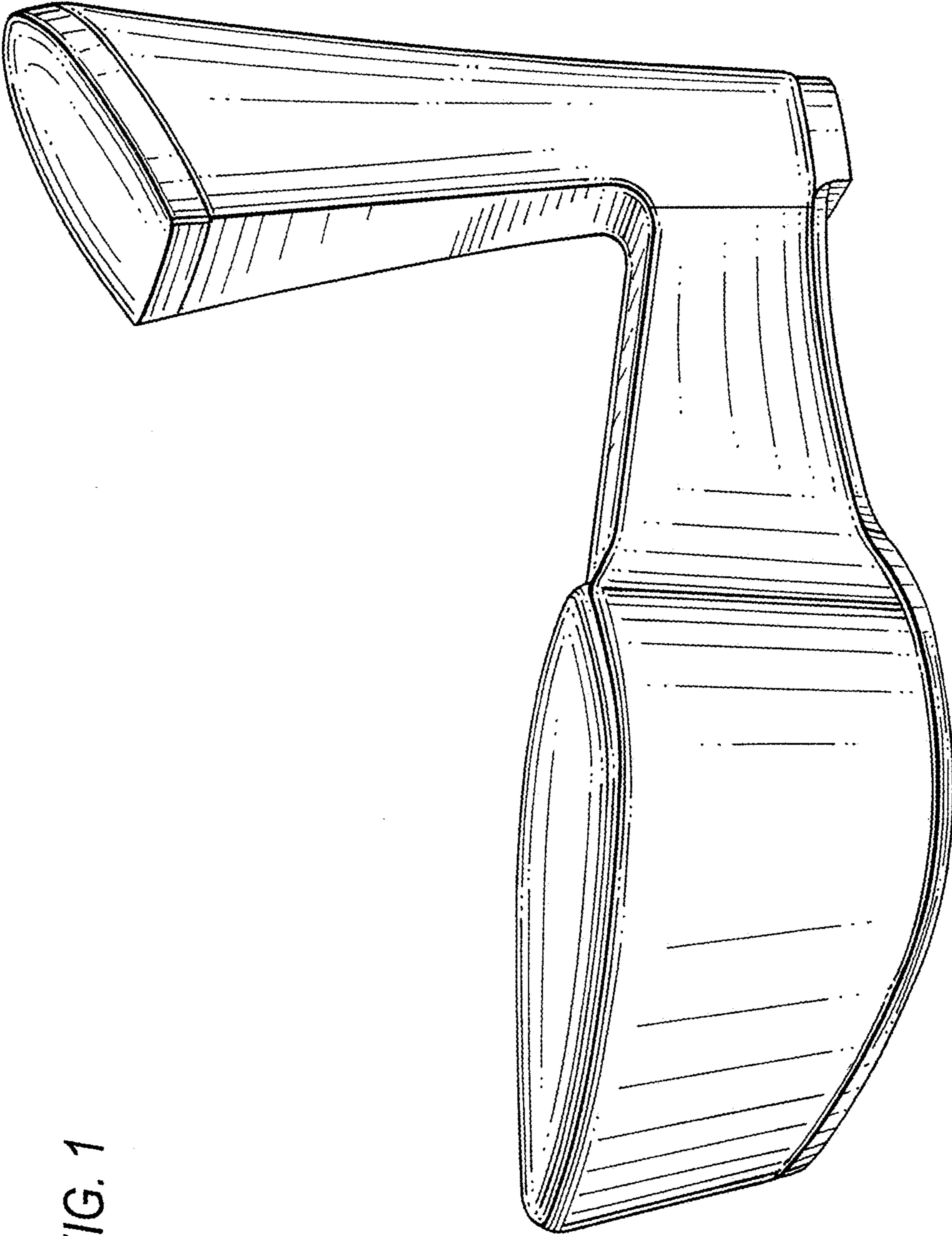
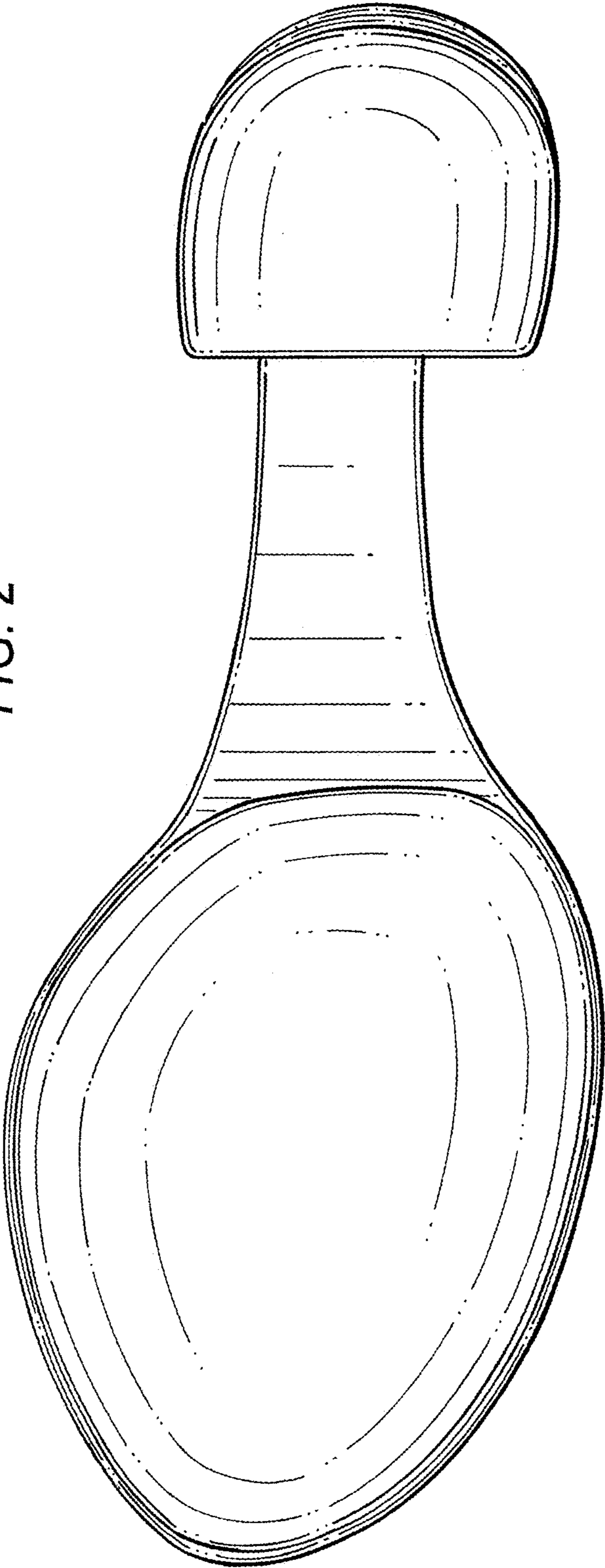

FIG. 1

FIG. 2



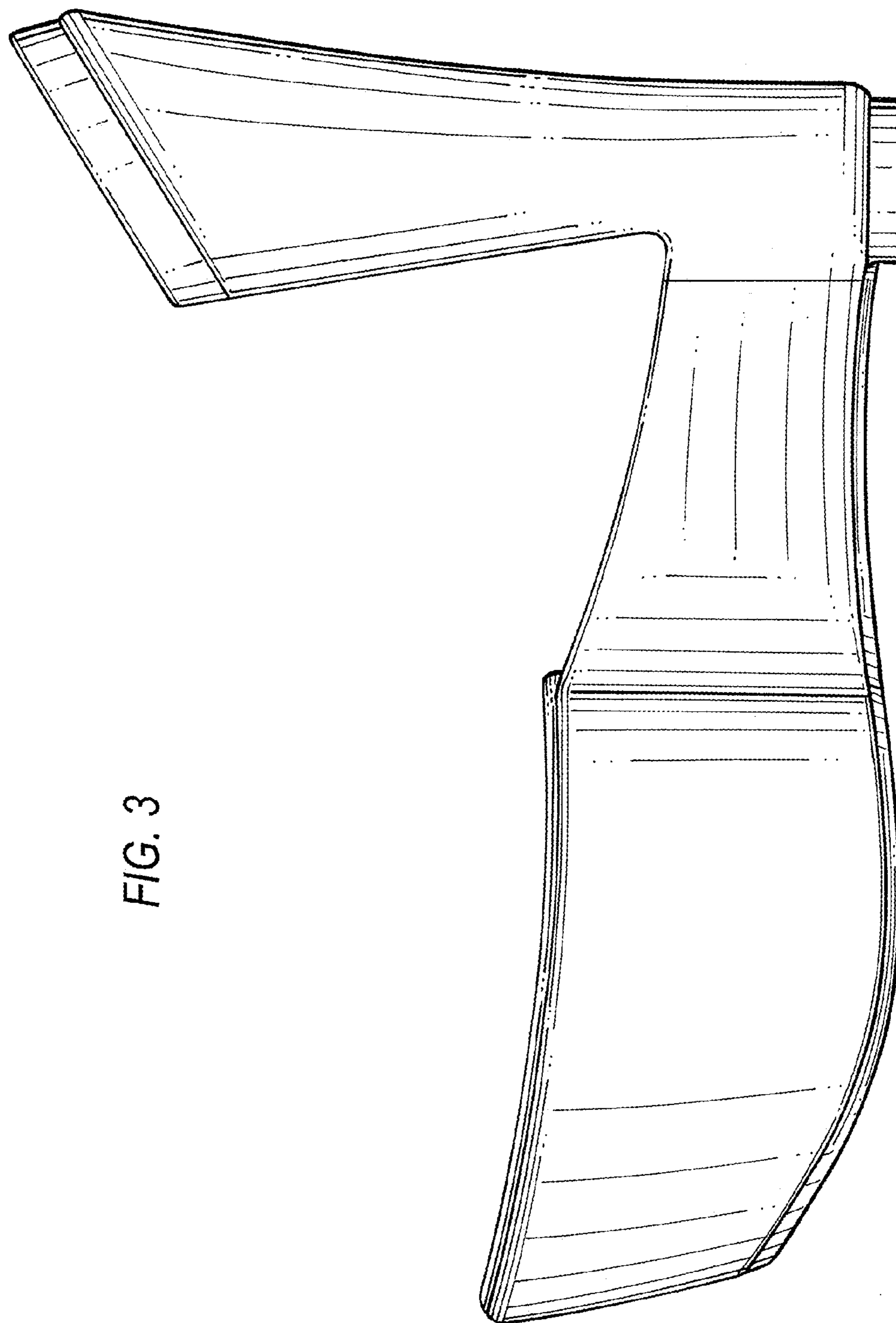

FIG. 3

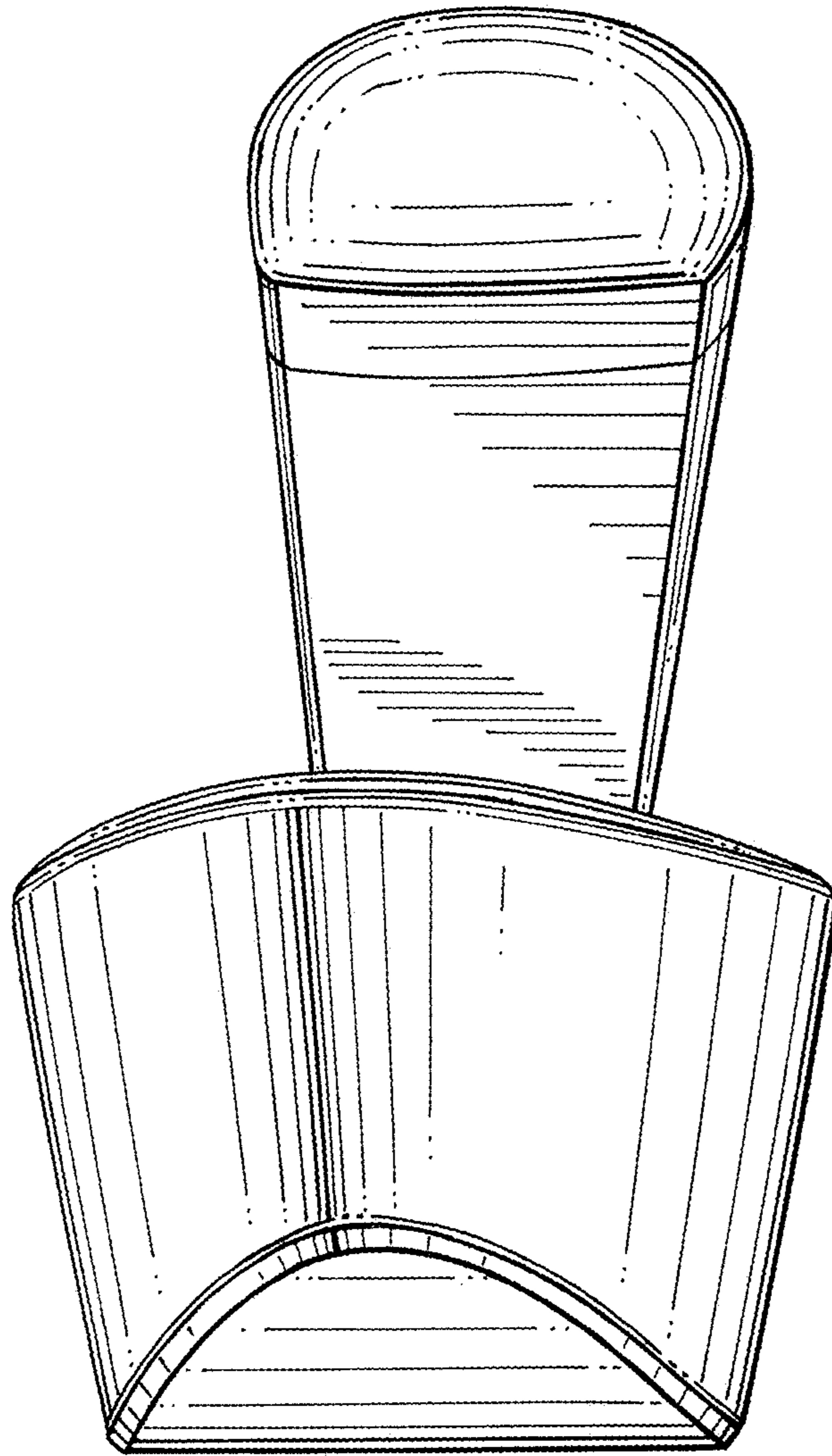
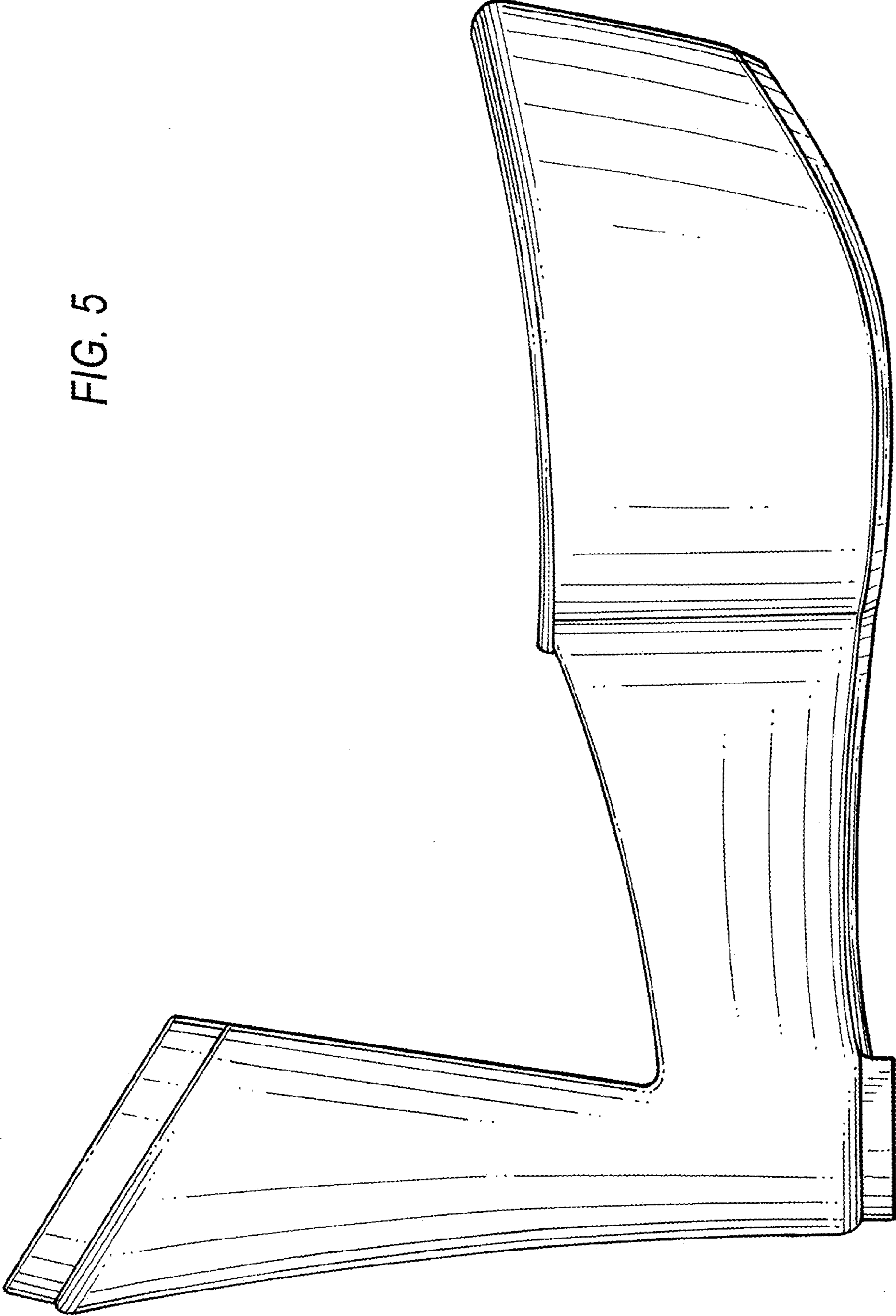

FIG. 4

FIG. 5



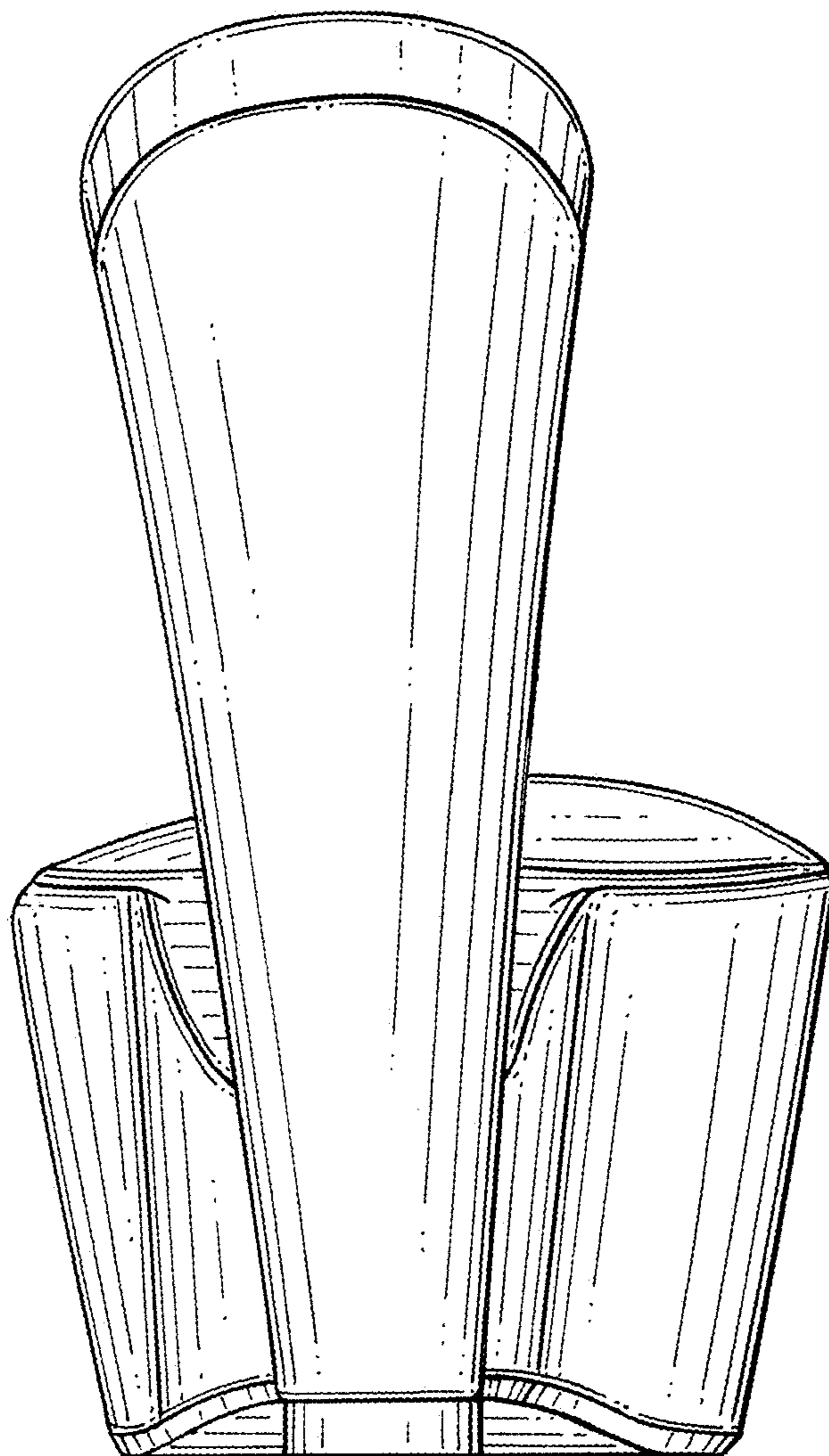

FIG. 6



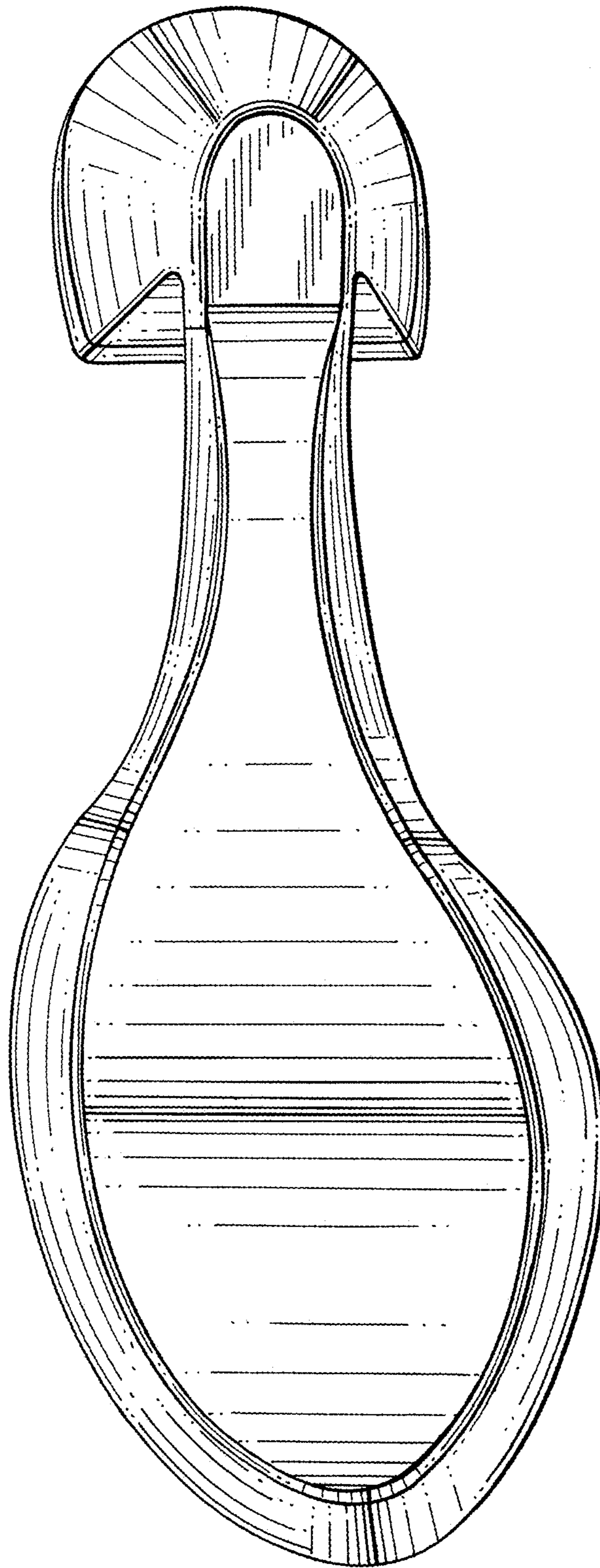

FIG. 7

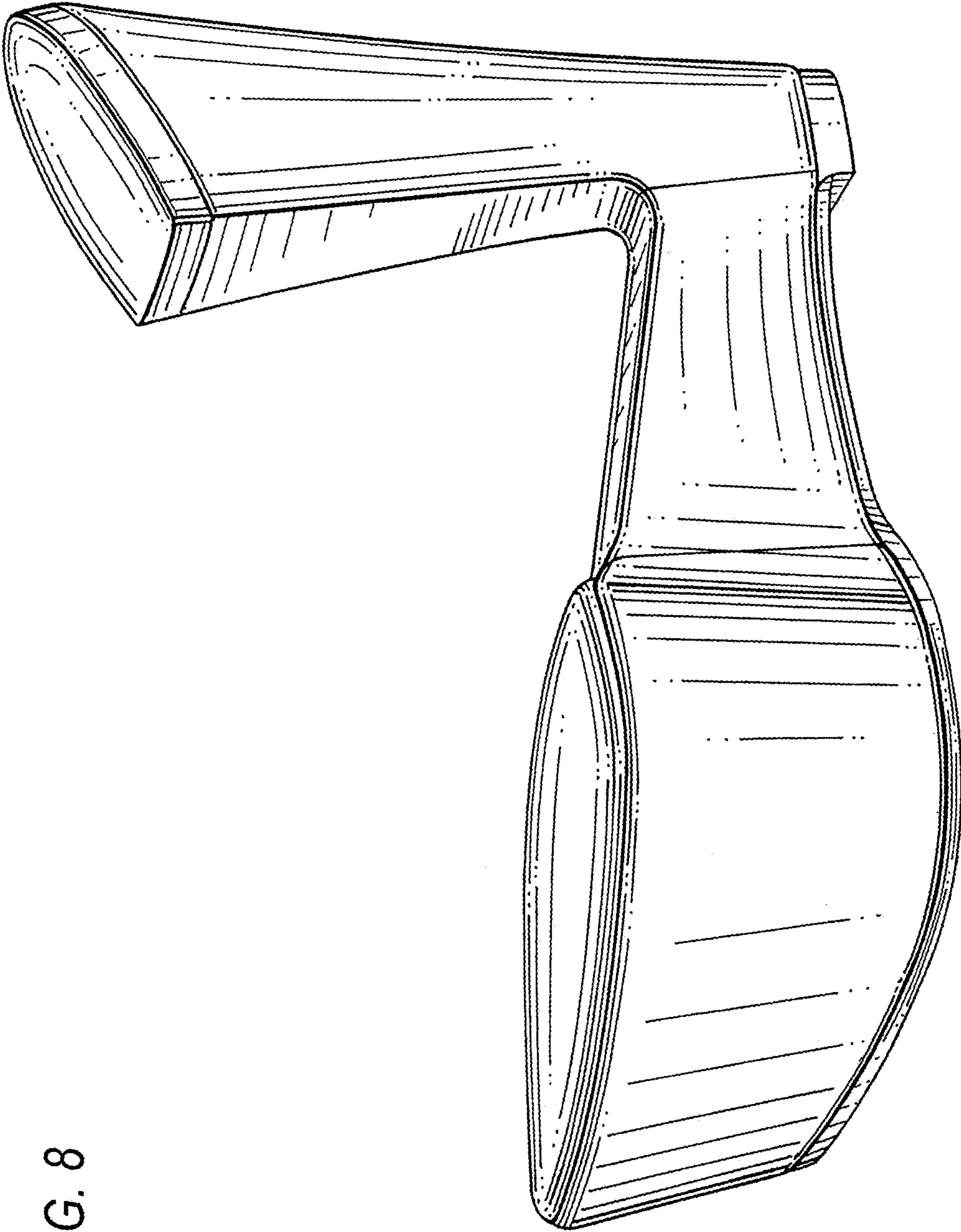
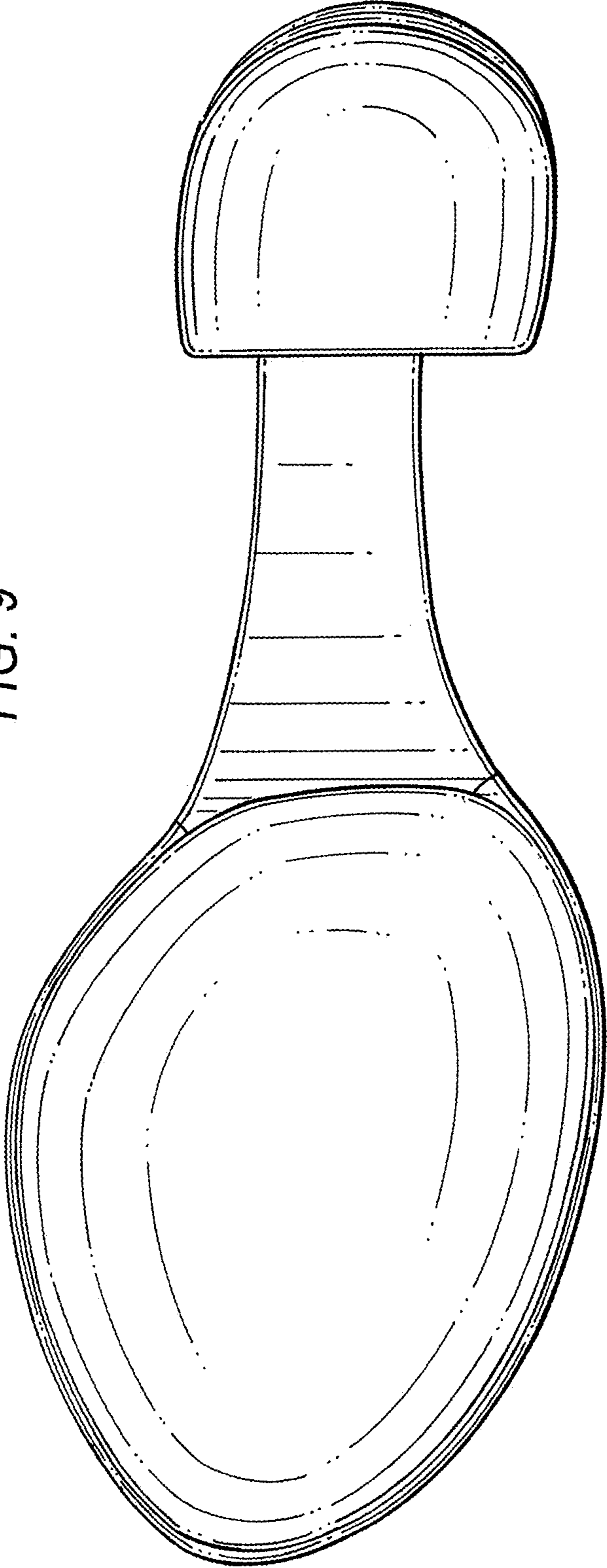

FIG. 8

FIG. 9



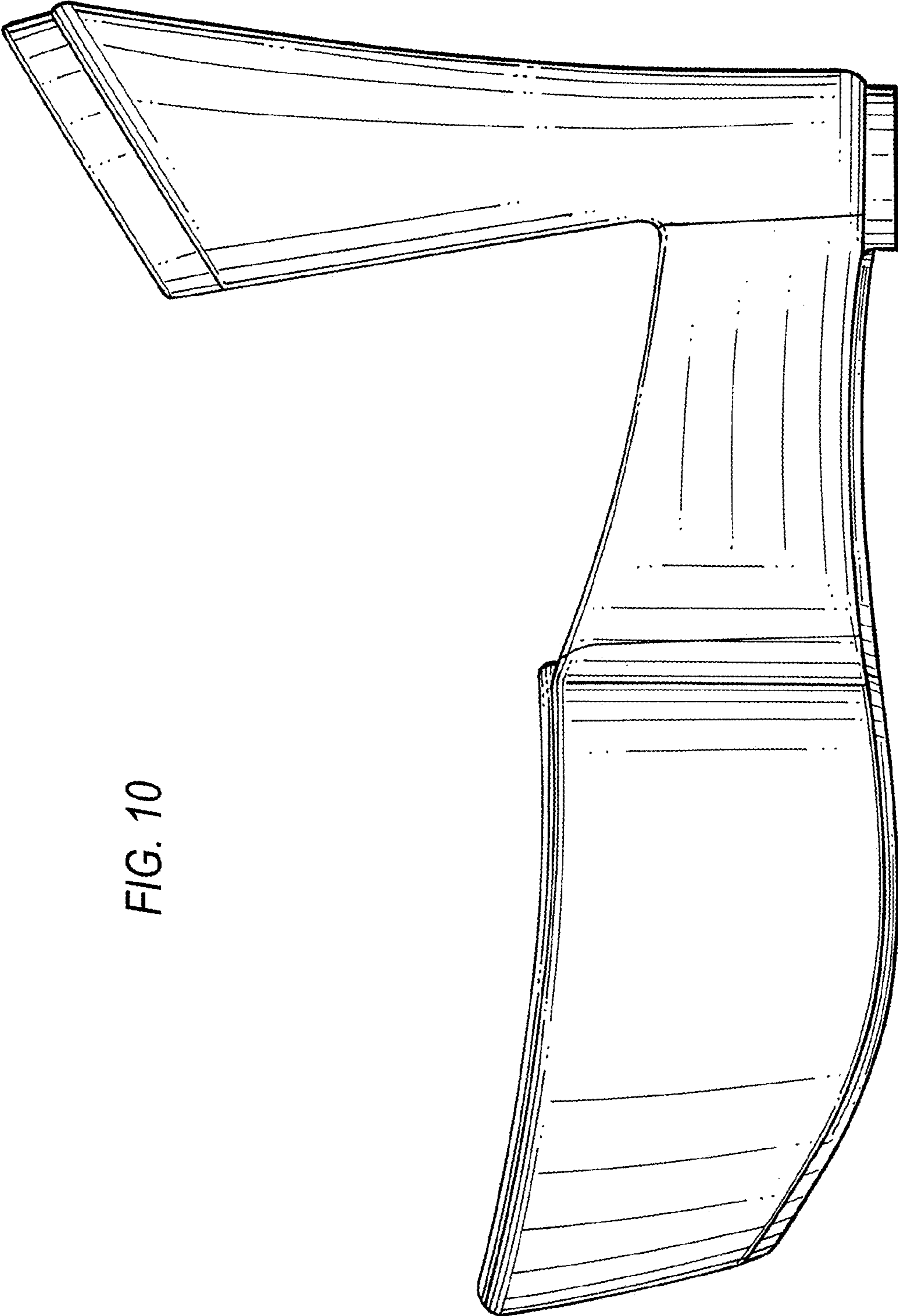

FIG. 10

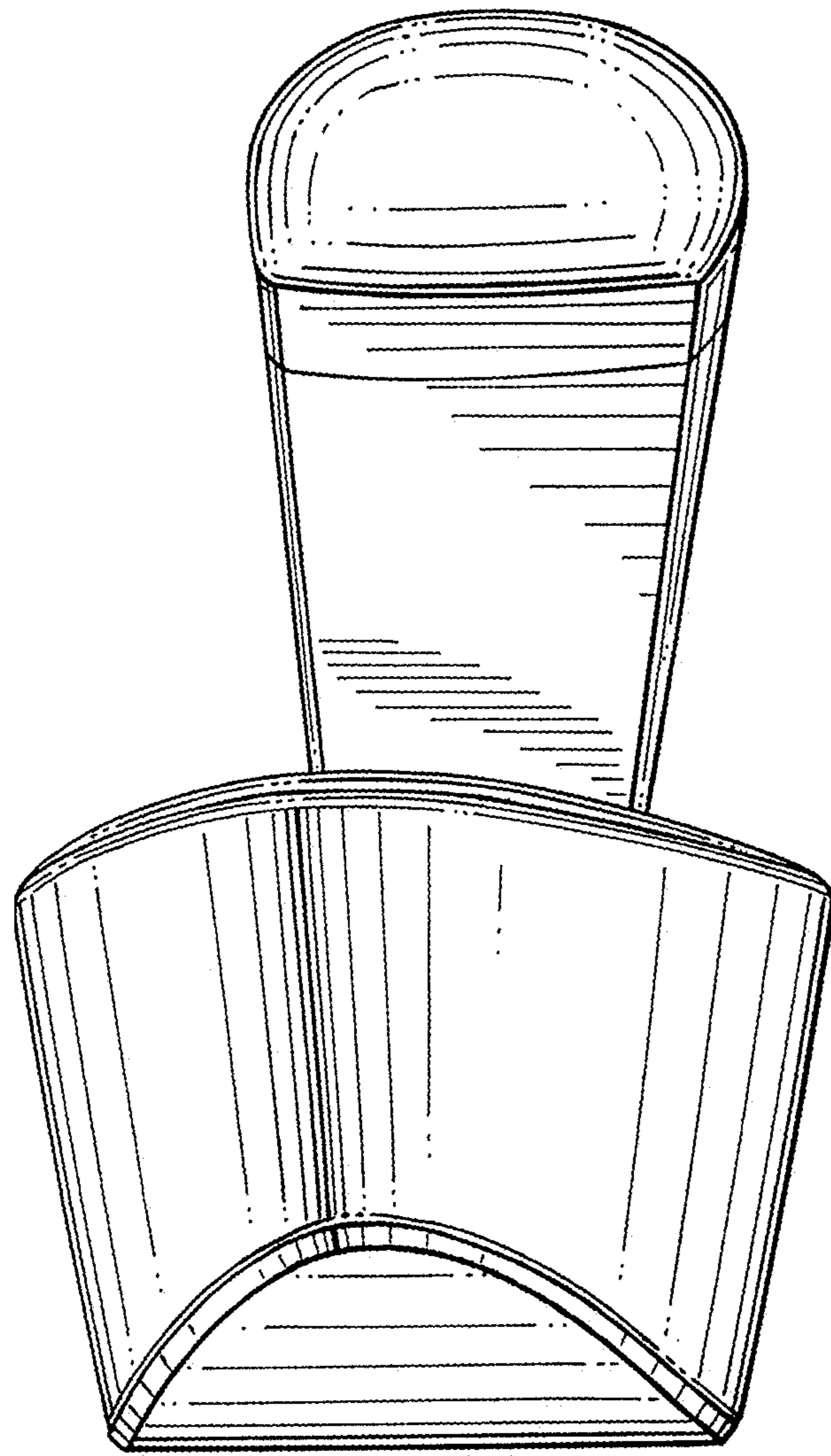
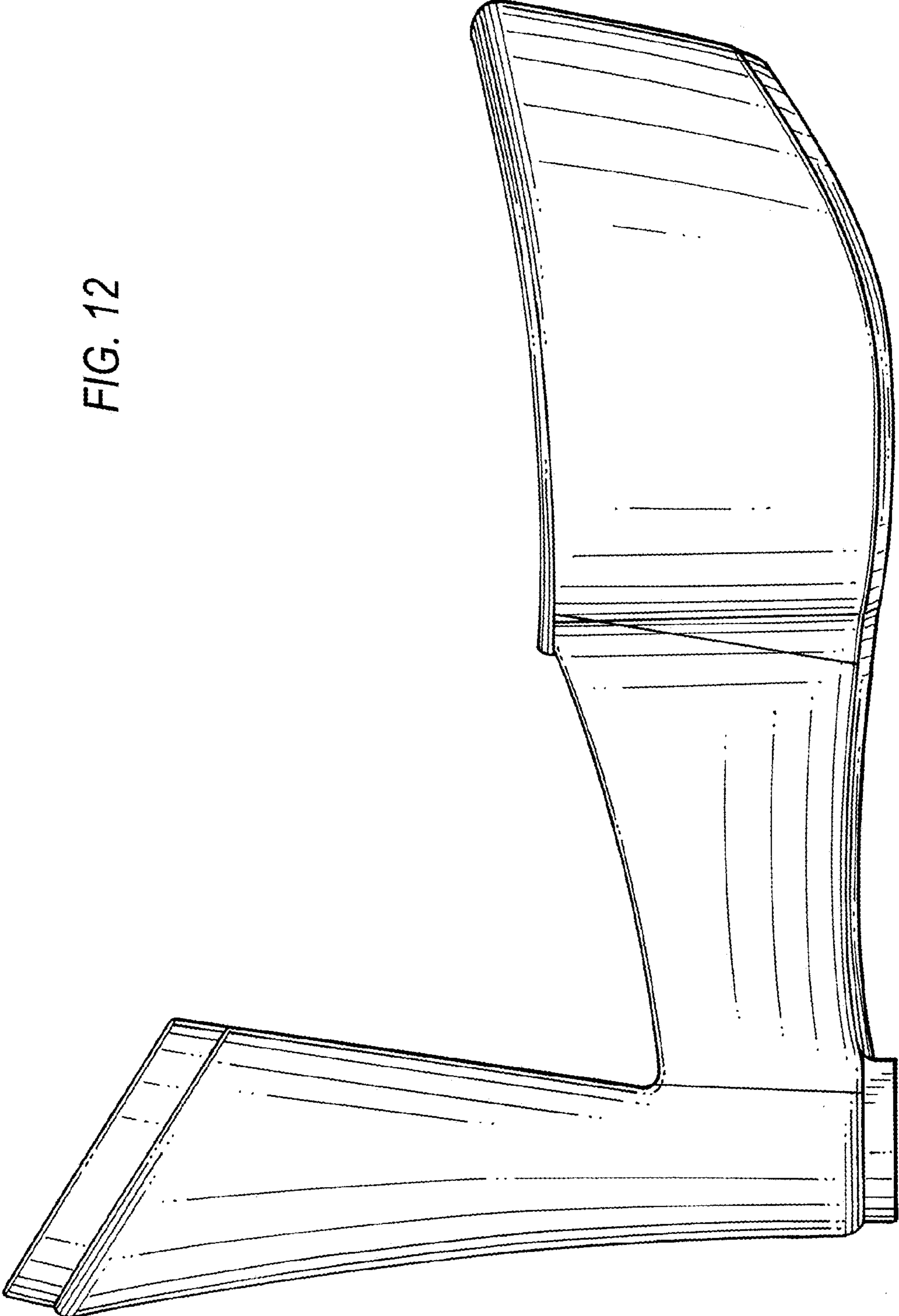

FIG. 11

FIG. 12



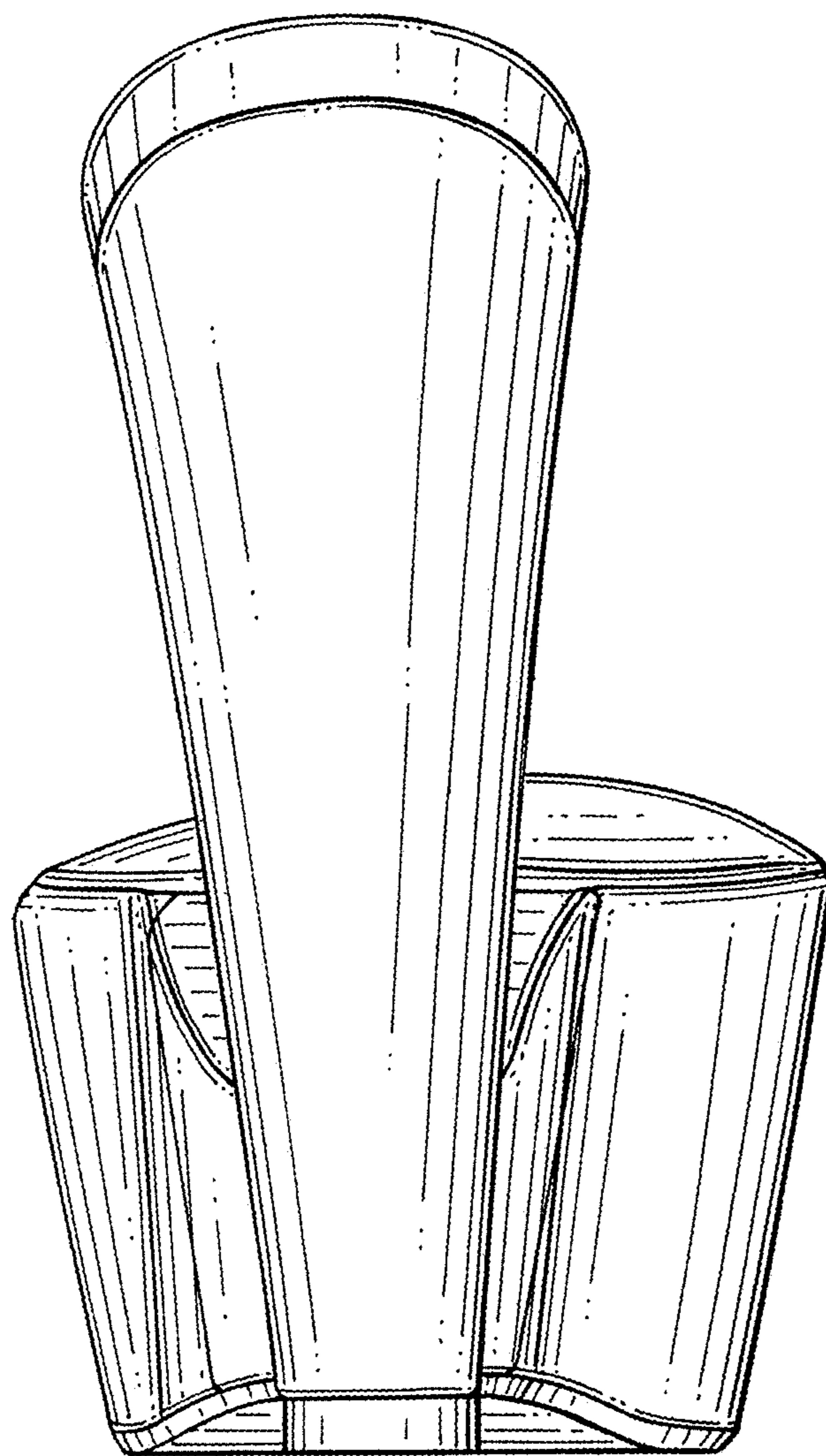

FIG. 13

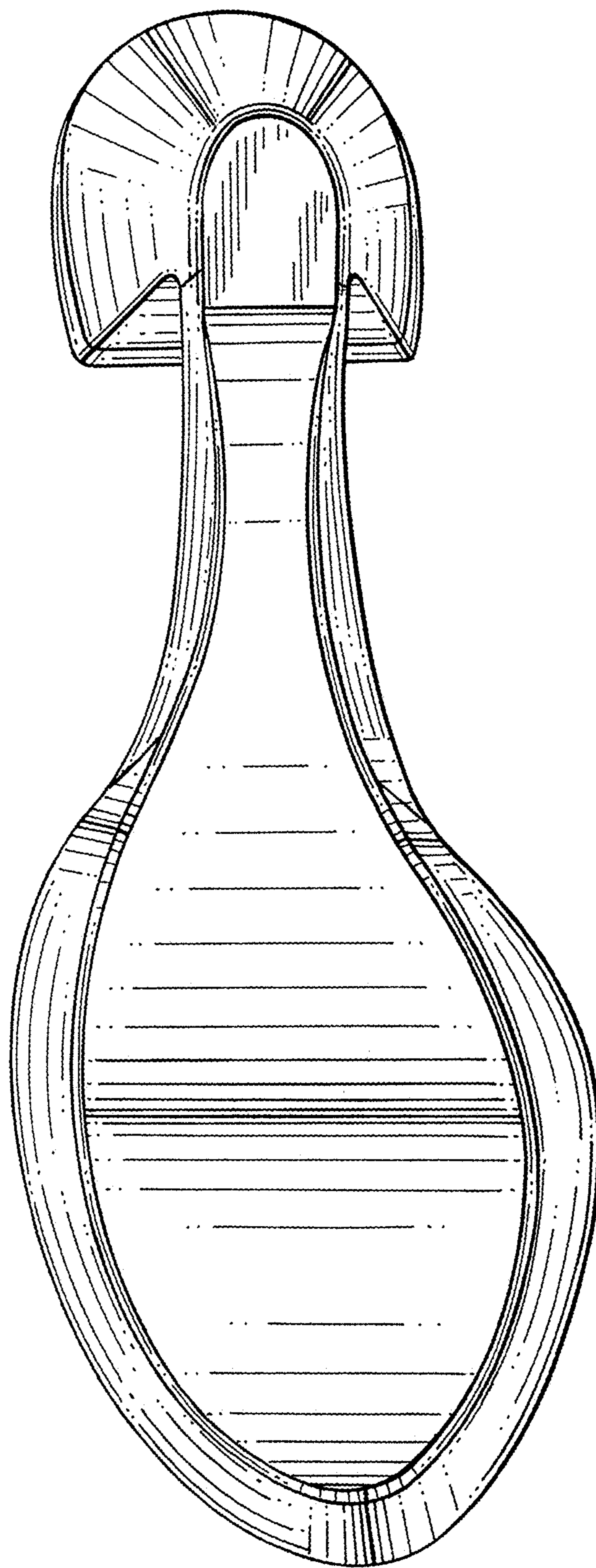

FIG. 14



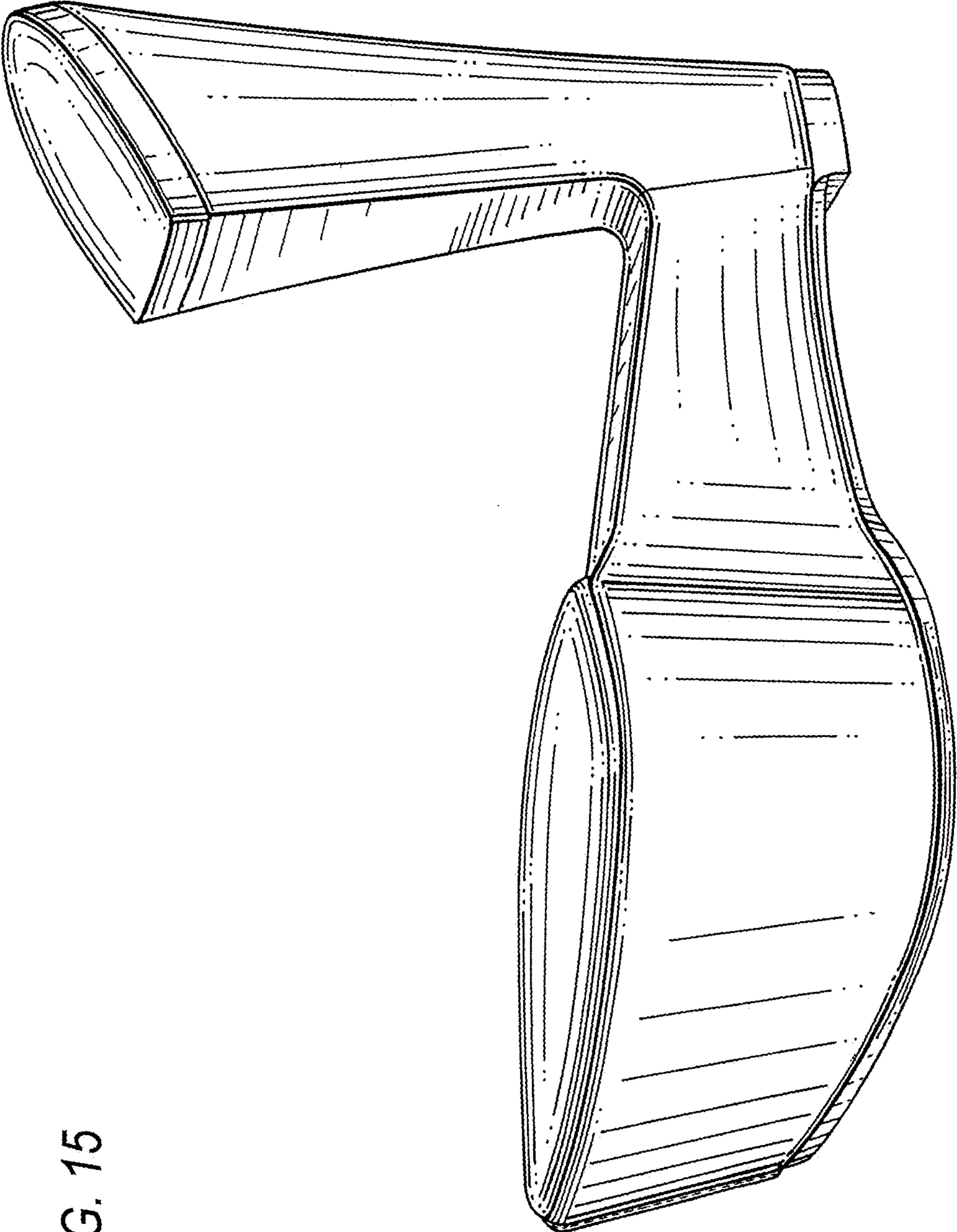

FIG. 15

FIG. 16



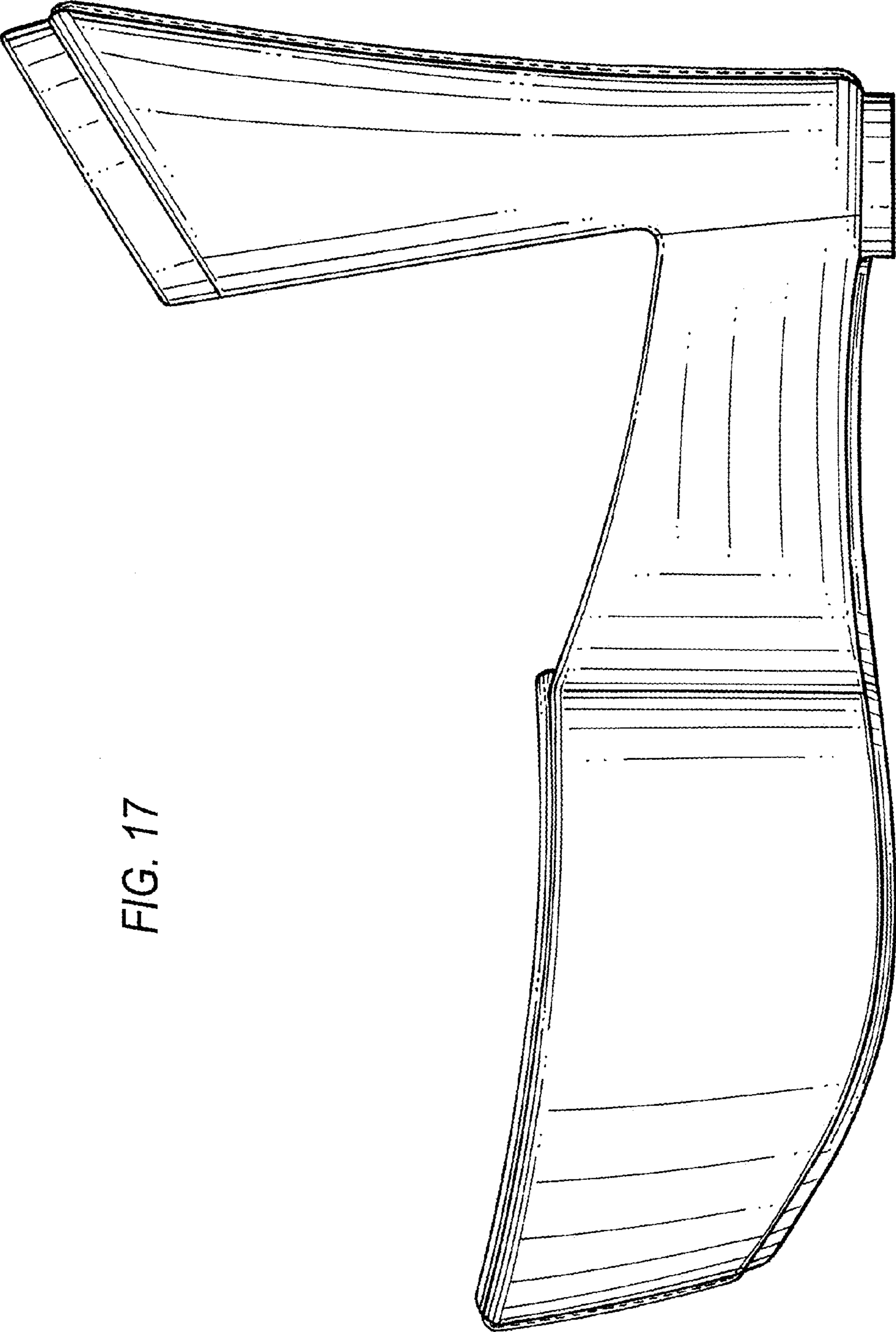

FIG. 17

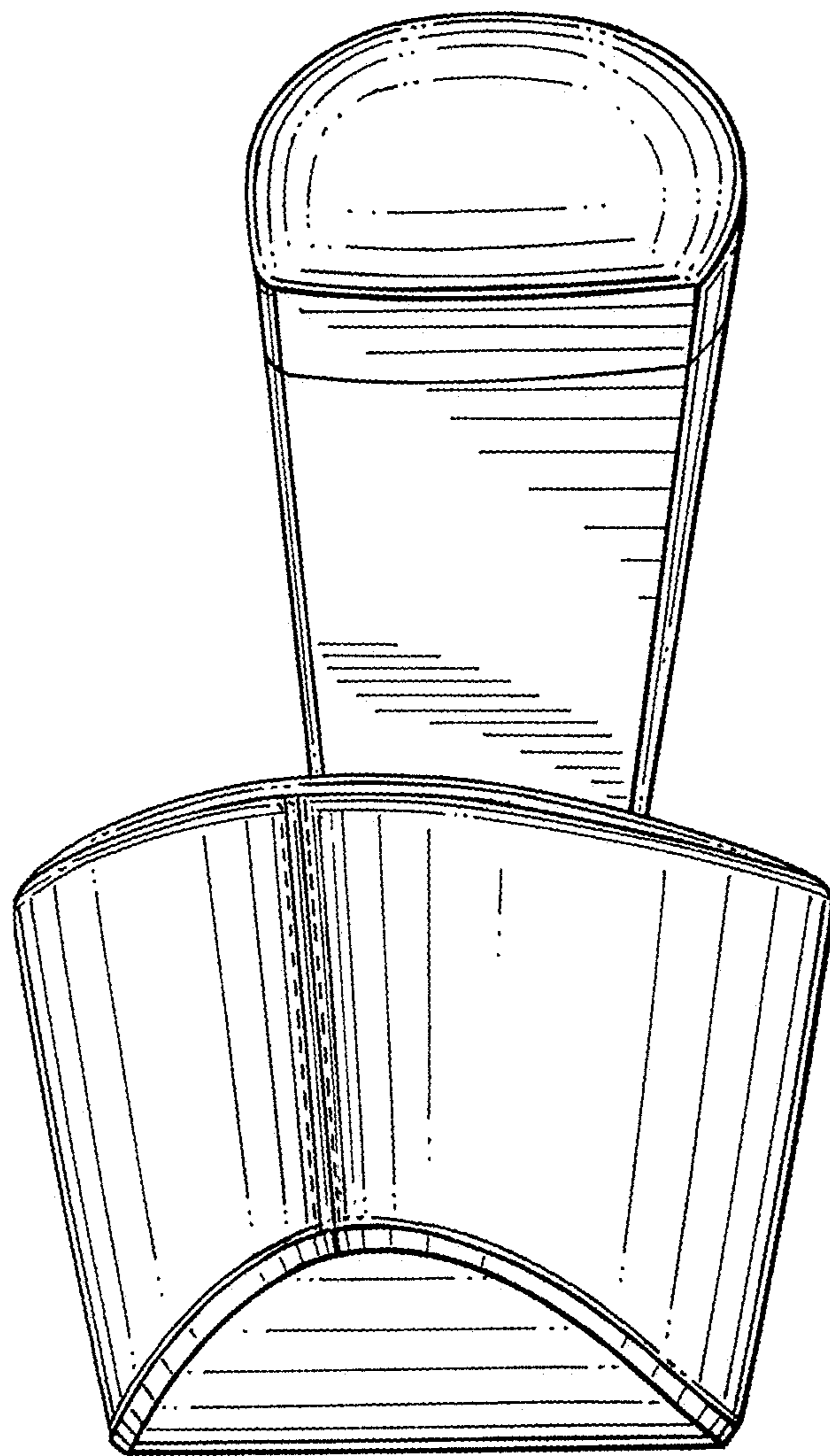
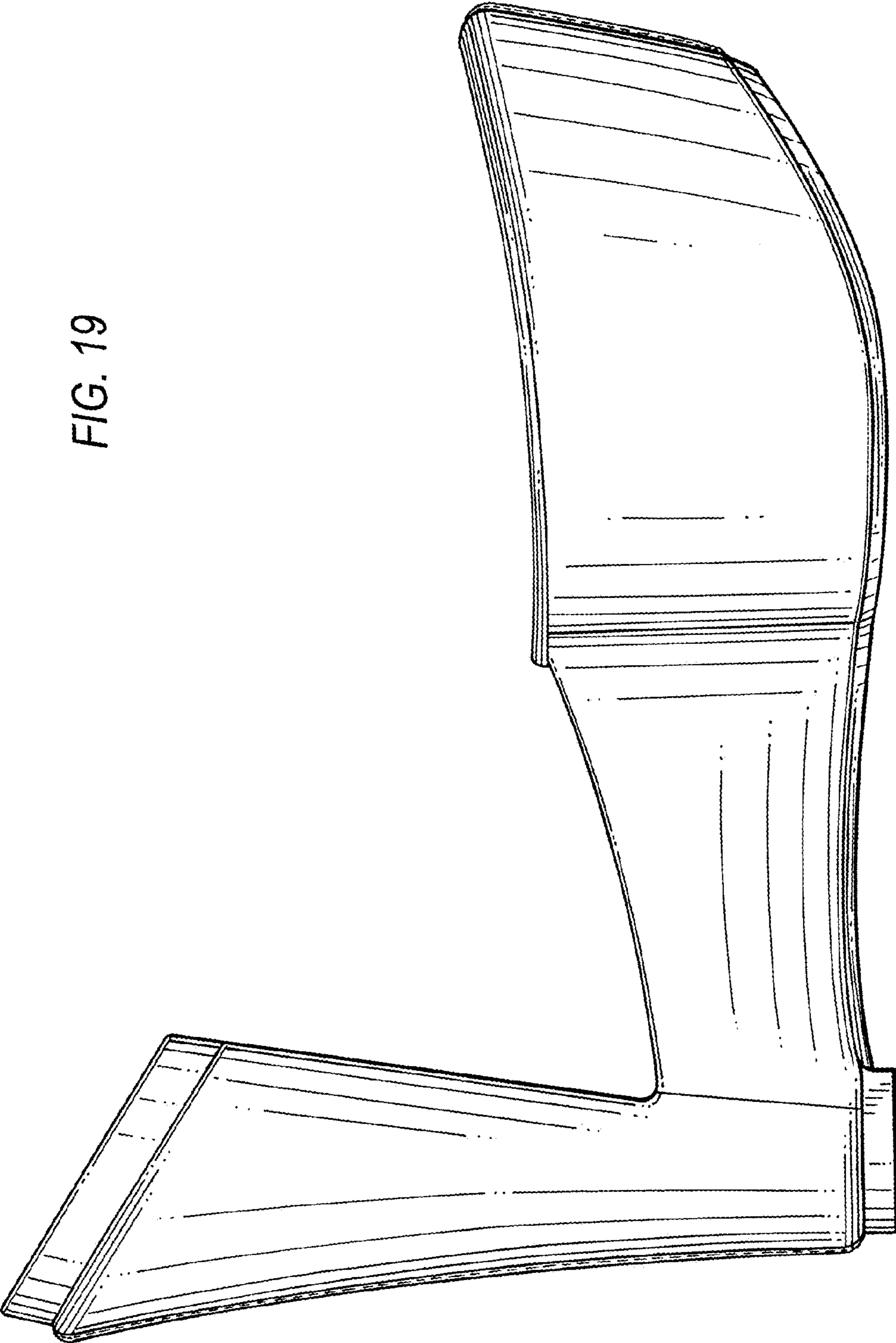

FIG. 18

FIG. 19



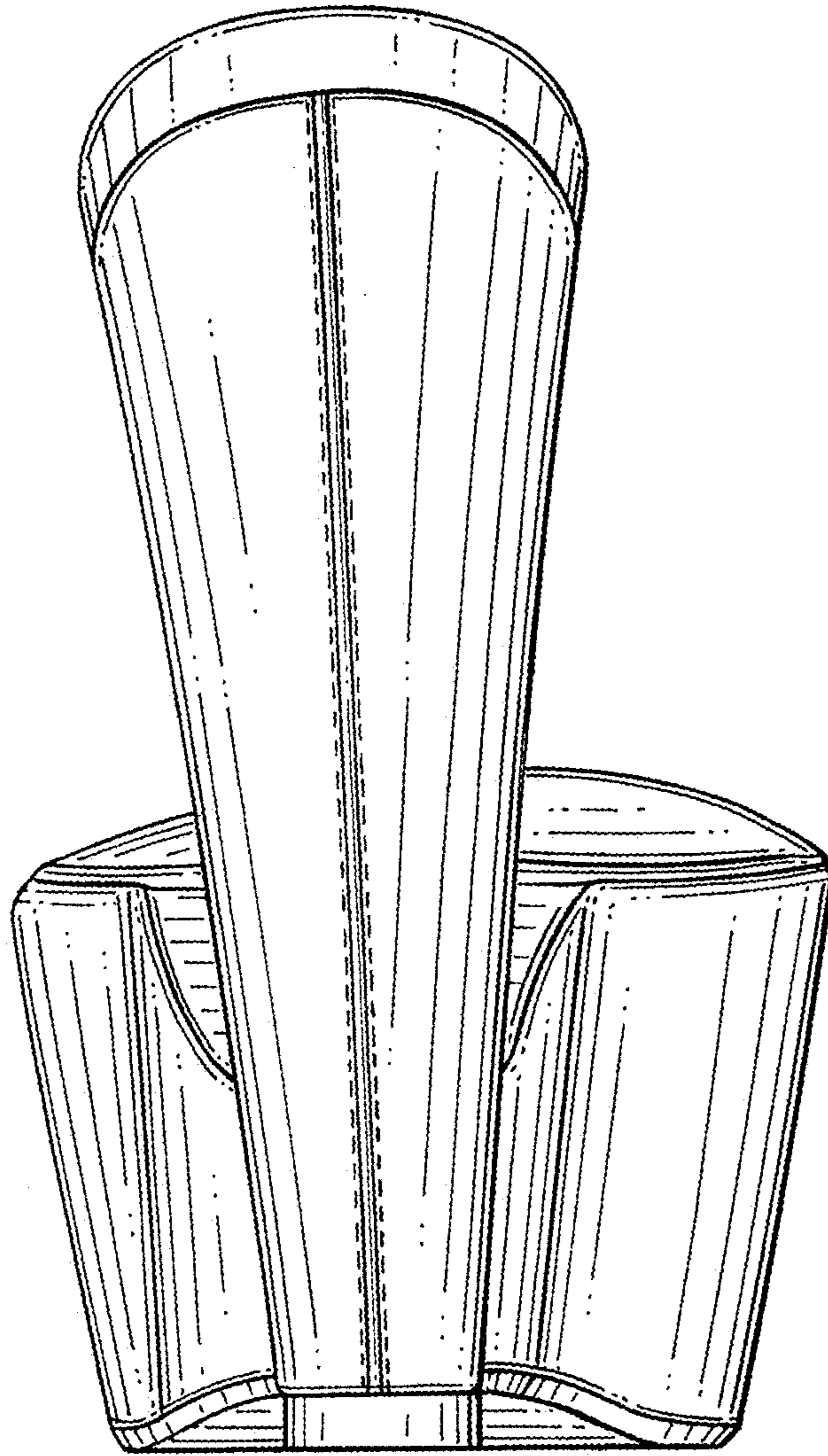

FIG. 20

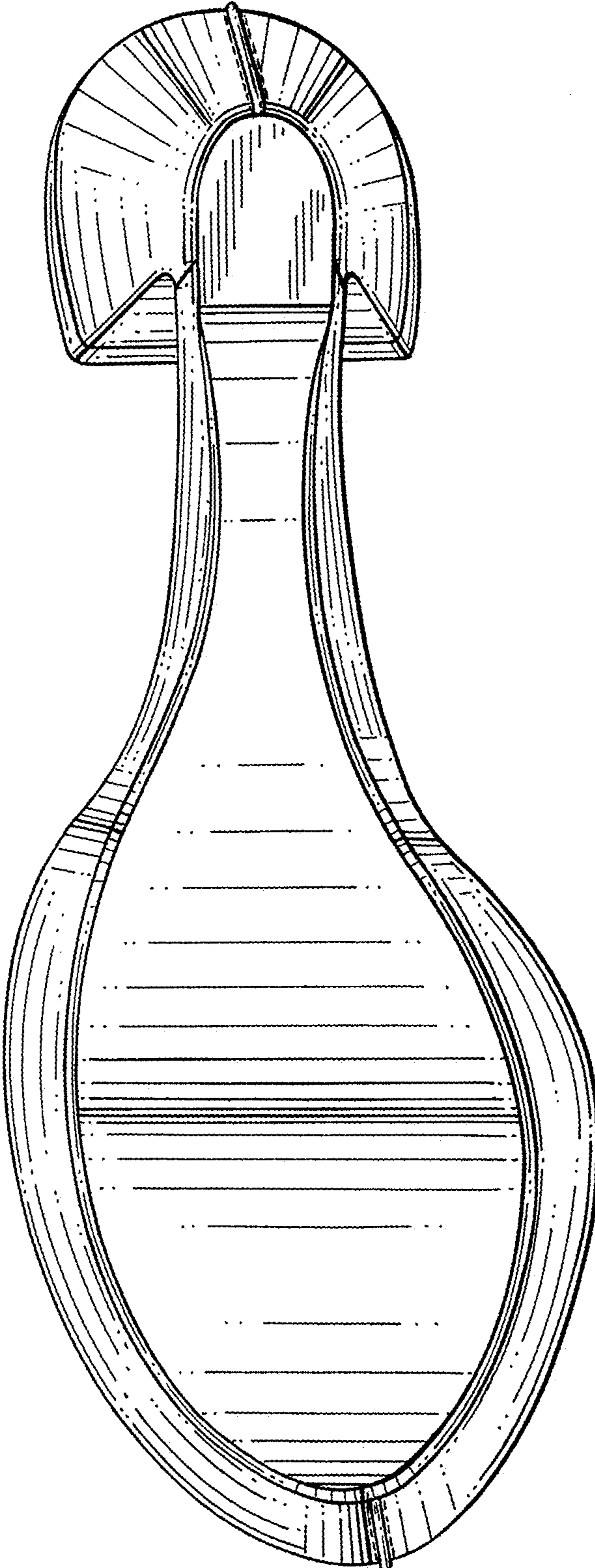

FIG. 21