



US00D686801S

(12) **United States Design Patent**
Farina

(10) **Patent No.:** **US D686,801 S**
(45) **Date of Patent:** **** Jul. 30, 2013**

(54) **GARMENT WAISTBAND**

(71) Applicant: **Under Armour, Inc.**, Baltimore, MD (US)

(72) Inventor: **Angela Farina**, Baltimore, MD (US)

(73) Assignee: **Under Armour, Inc.**, Baltimore, MD (US)

(**) Term: **14 Years**

(21) Appl. No.: **29/438,952**

(22) Filed: **Dec. 5, 2012**

(51) **LOC (9) Cl.** **02-02**

(52) **U.S. Cl.**
USPC **D2/853; D2/742**

(58) **Field of Classification Search**
USPC D2/712, 713, 731, 732, 737, 738,
D2/742, 853, 857, 983; 2/79, 227, 228,
235-238, 242, 247
See application file for complete search history.

(56) **References Cited**

U.S. PATENT DOCUMENTS

D235,937	S	*	7/1975	Froidh et al.	D24/126
D275,619	S	*	9/1984	Birring	D24/126
D281,540	S	*	12/1985	Ternstrom	D24/126
D284,036	S	*	6/1986	Birring	D24/126
5,954,564	A	*	9/1999	Ganz	450/99

D618,434	S	*	6/2010	Iamartino et al.	D2/742
D618,435	S	*	6/2010	Iamartino et al.	D2/742
D660,553	S	*	5/2012	Farina et al.	D2/742
D668,434	S	*	10/2012	Iamartino	D2/742
D673,756	S	*	1/2013	Agnew et al.	D2/742
2011/0131705	A1	*	6/2011	Waldman et al.	2/221
2012/0036615	A1	*	2/2012	Bradstreet et al.	2/236

* cited by examiner

Primary Examiner — Rashida Johnson

(74) *Attorney, Agent, or Firm* — Wesley W. Muller

(57) **CLAIM**

The ornamental design for a garment waistband, as shown and described.

DESCRIPTION

FIG. 1 is a perspective view of a garment waistband according to the present invention;
FIG. 2 is a front view of the garment waistband of FIG. 1;
FIG. 3 is a rear view of the garment waistband of FIG. 1;
FIG. 4 is a left side view of the garment waistband of FIG. 1;
FIG. 5 is a right side view of the garment waistband of FIG. 1;
and,
FIG. 6 is a top view of the garment waistband of FIG. 1.

The broken lines in the figures merely illustrate the environment for the garment waistband of the present design and therefore form no part of the claimed design.

1 Claim, 6 Drawing Sheets

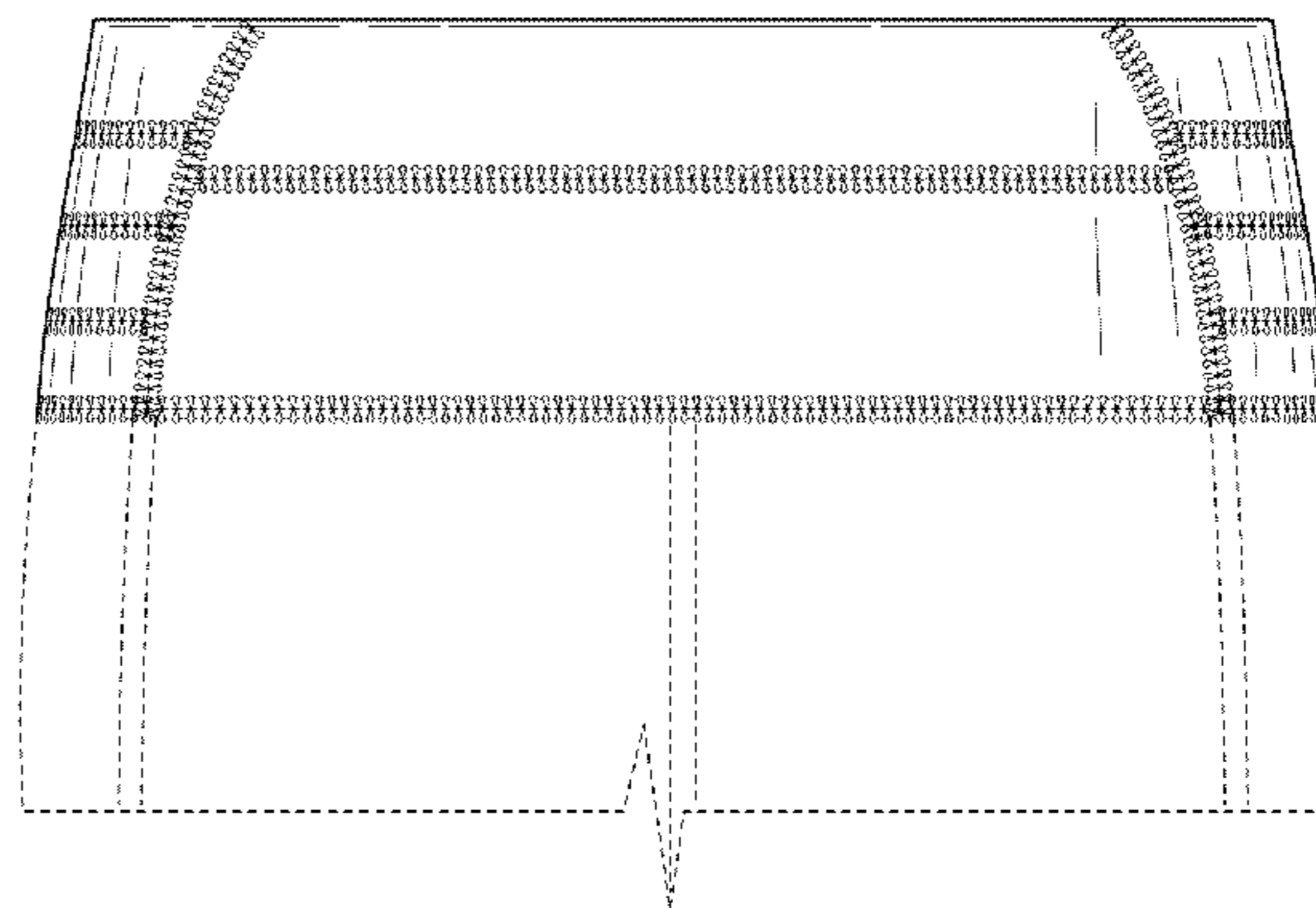
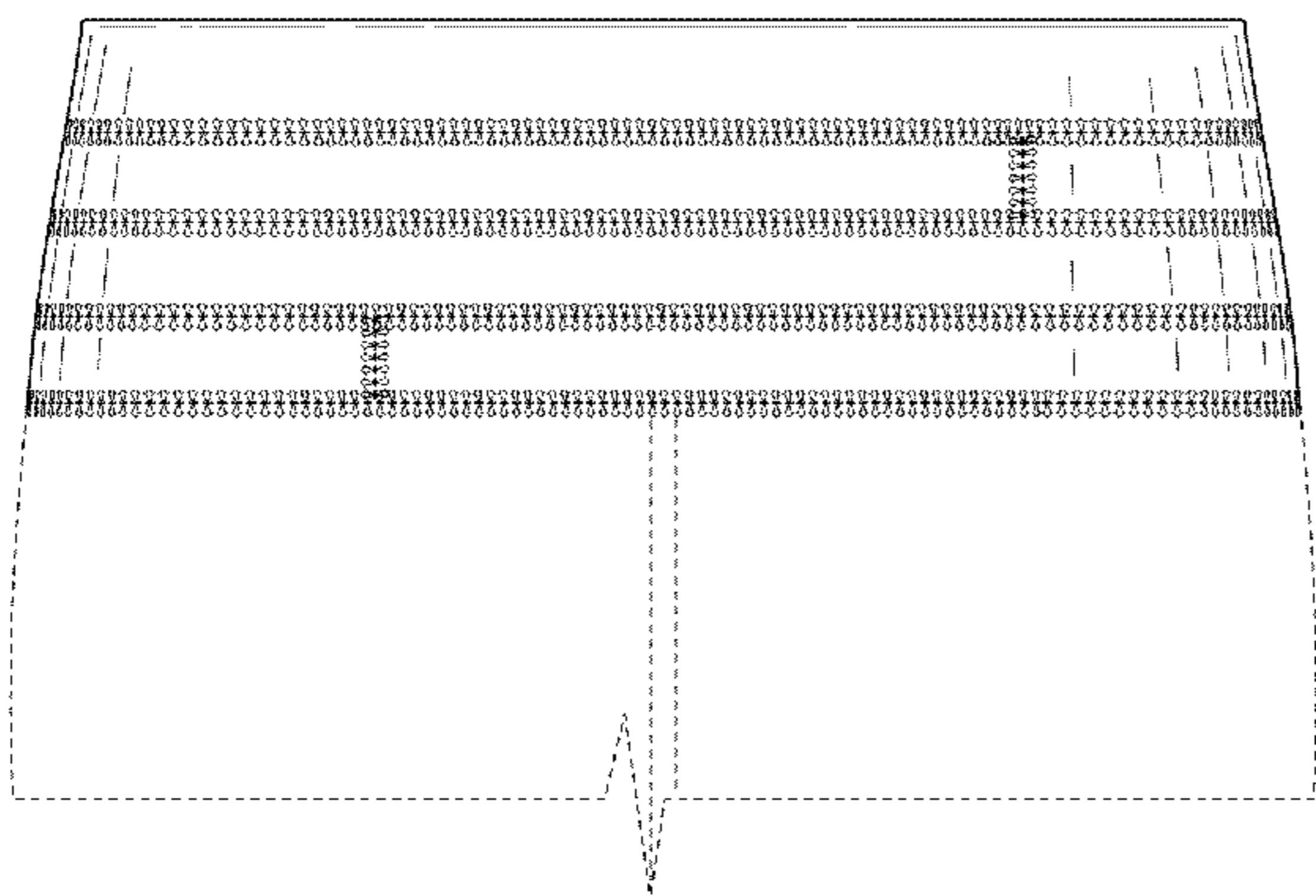

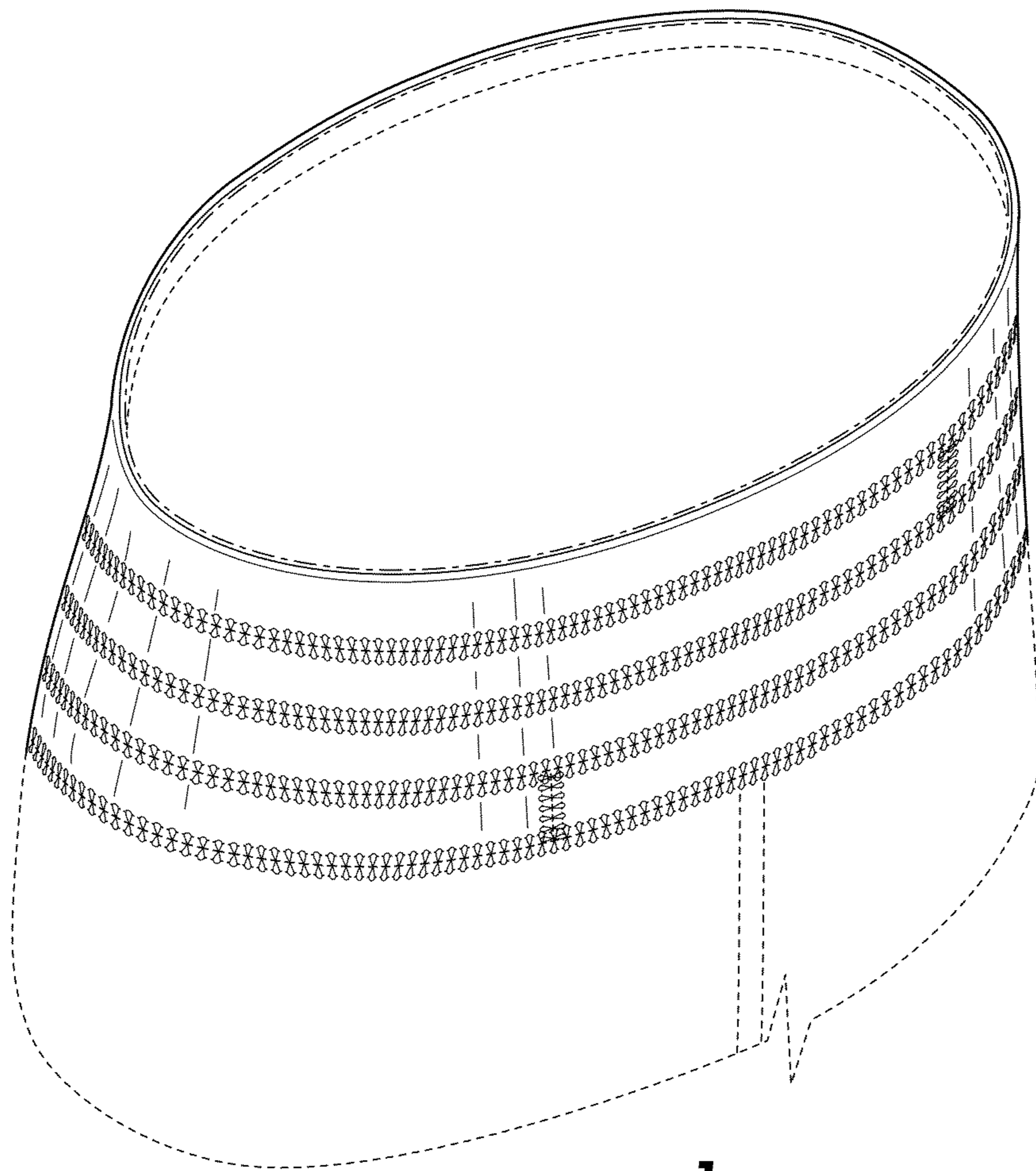

FIG. 1

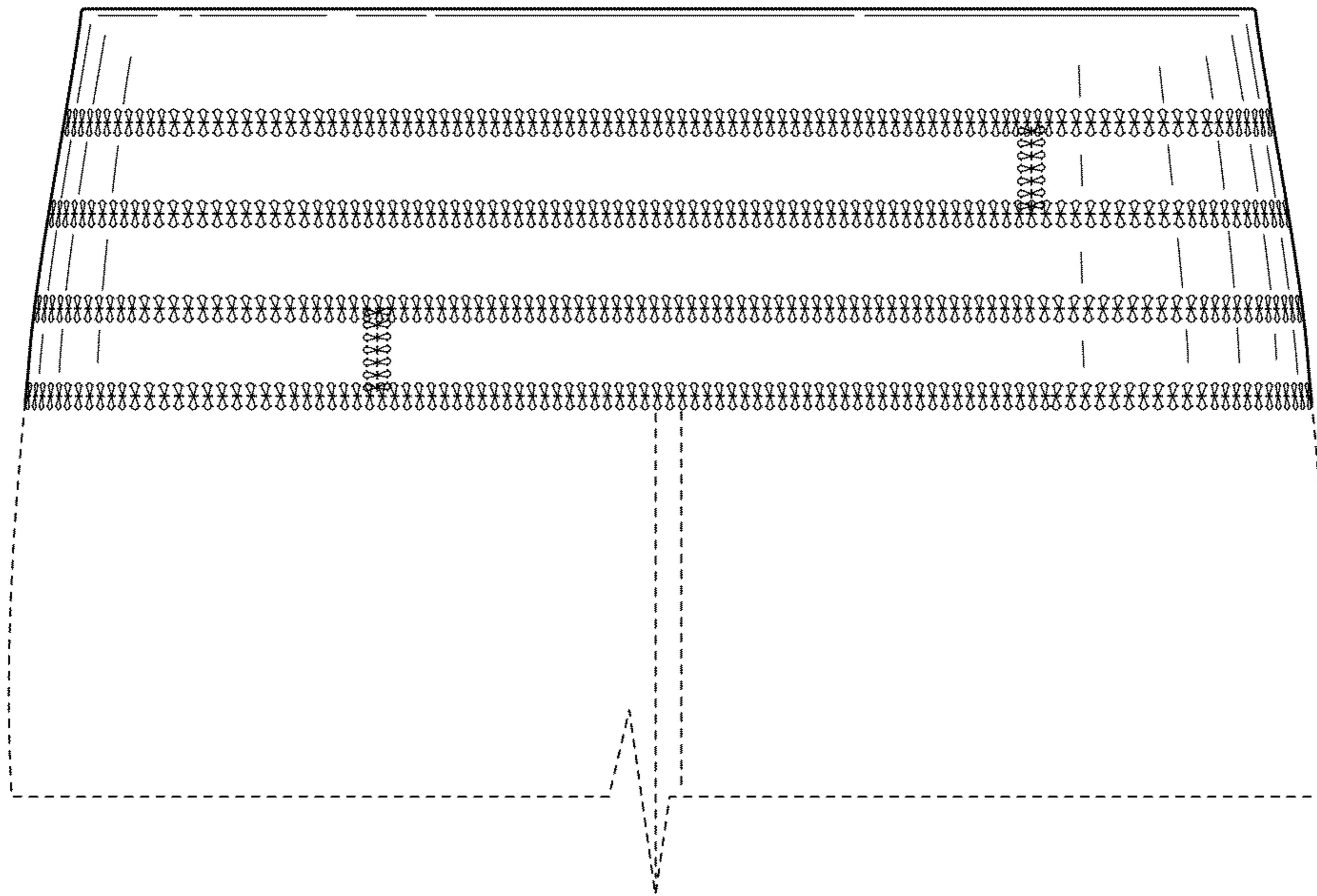

FIG. 2

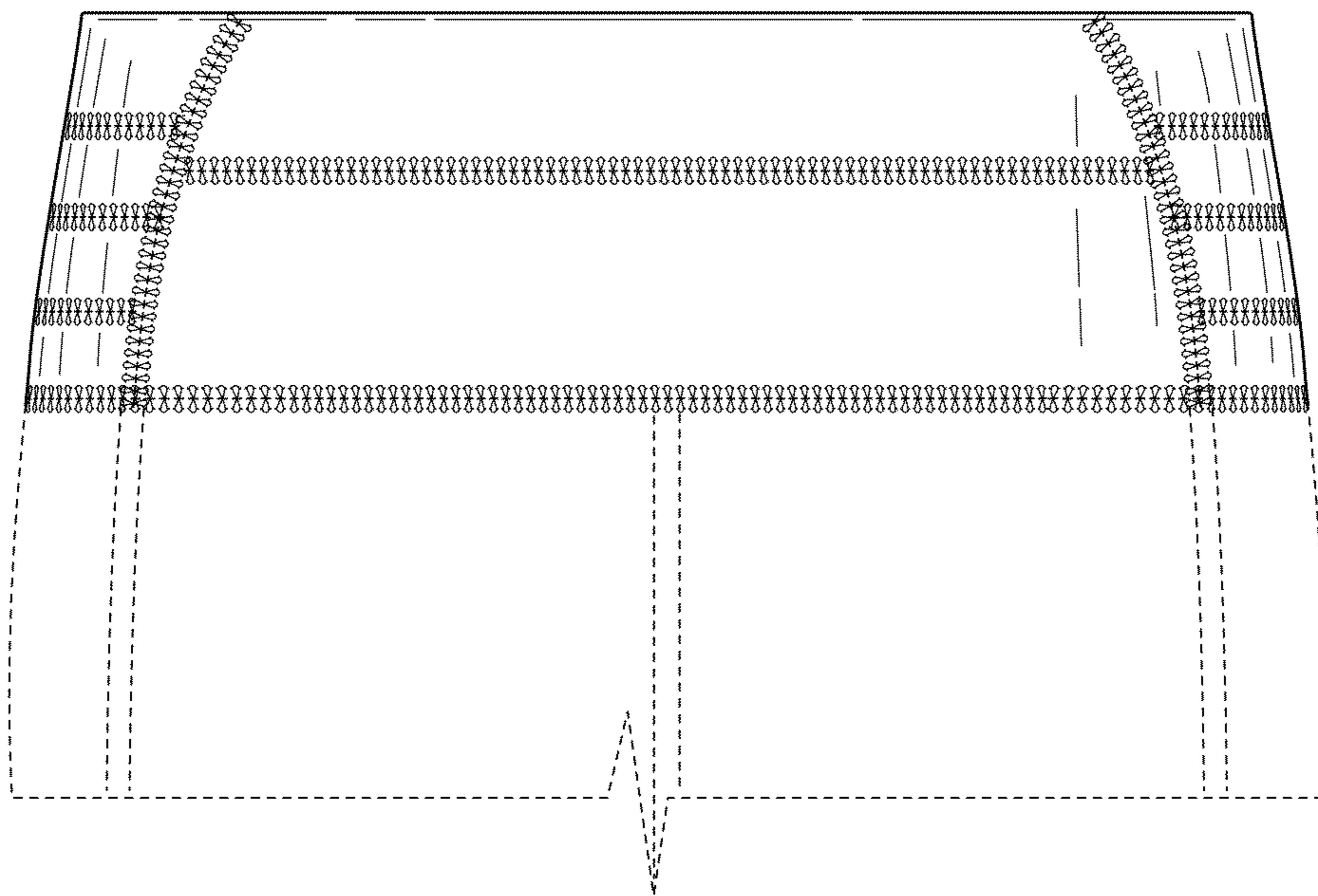

FIG. 3

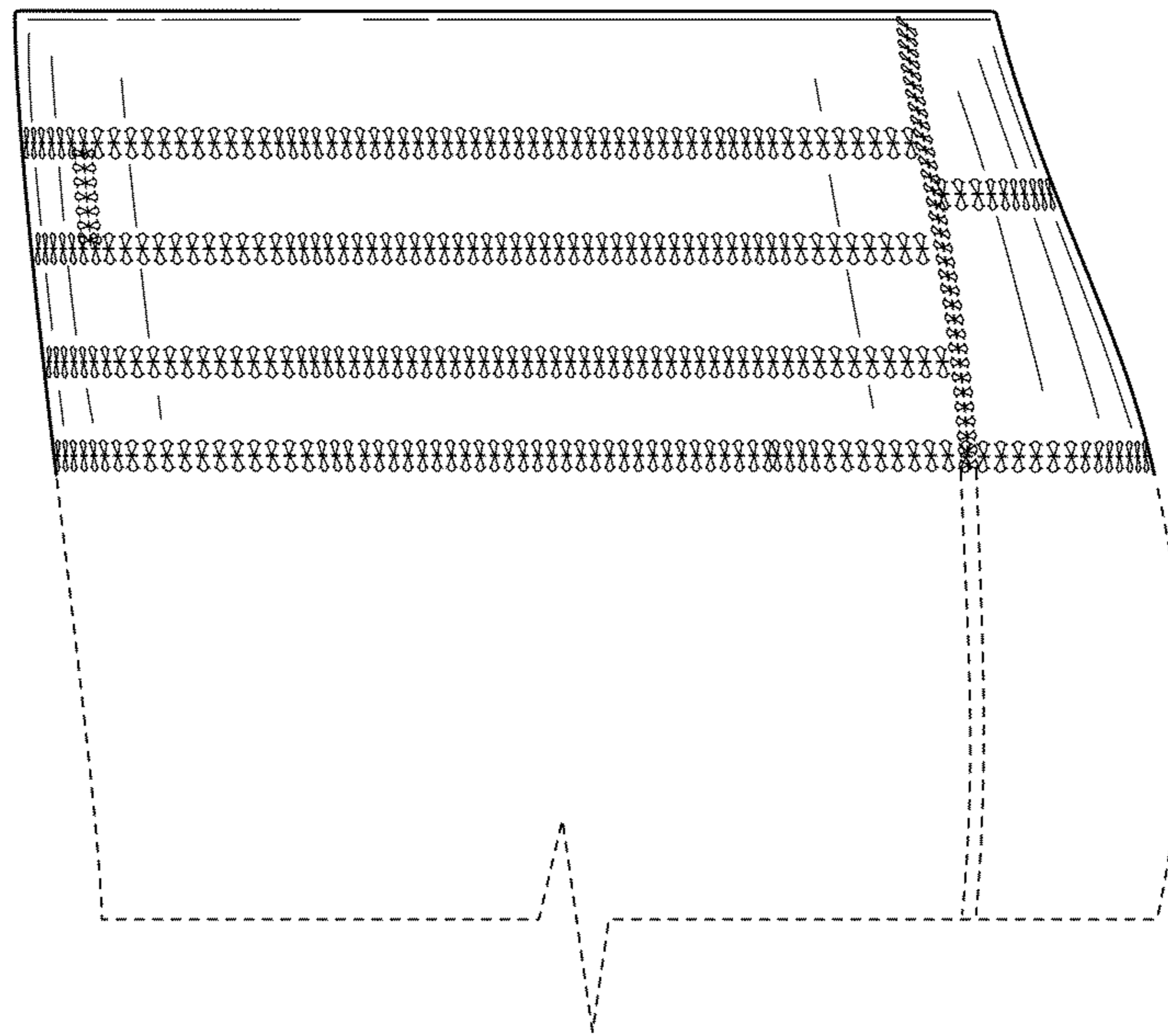

FIG. 4

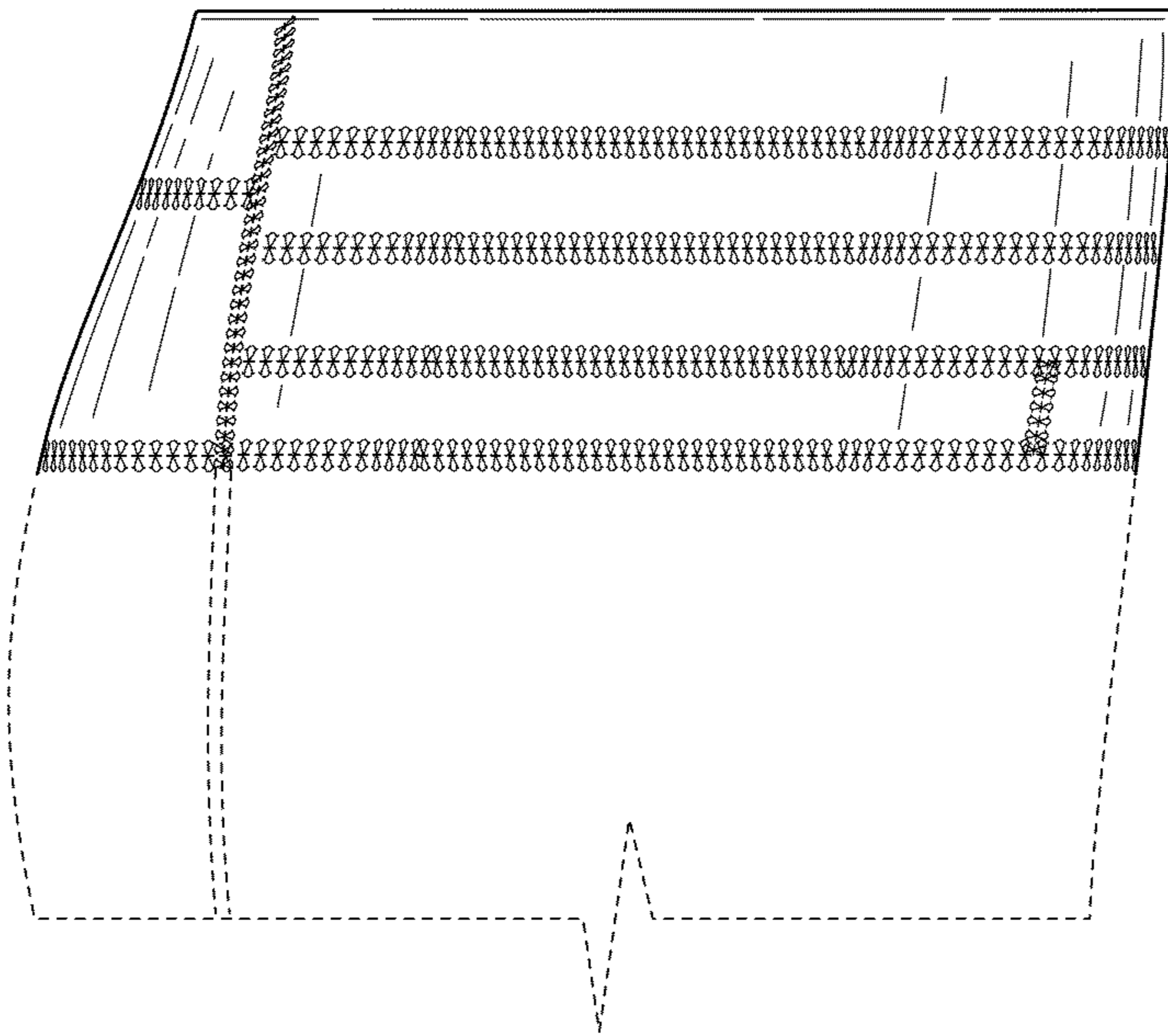

FIG. 5

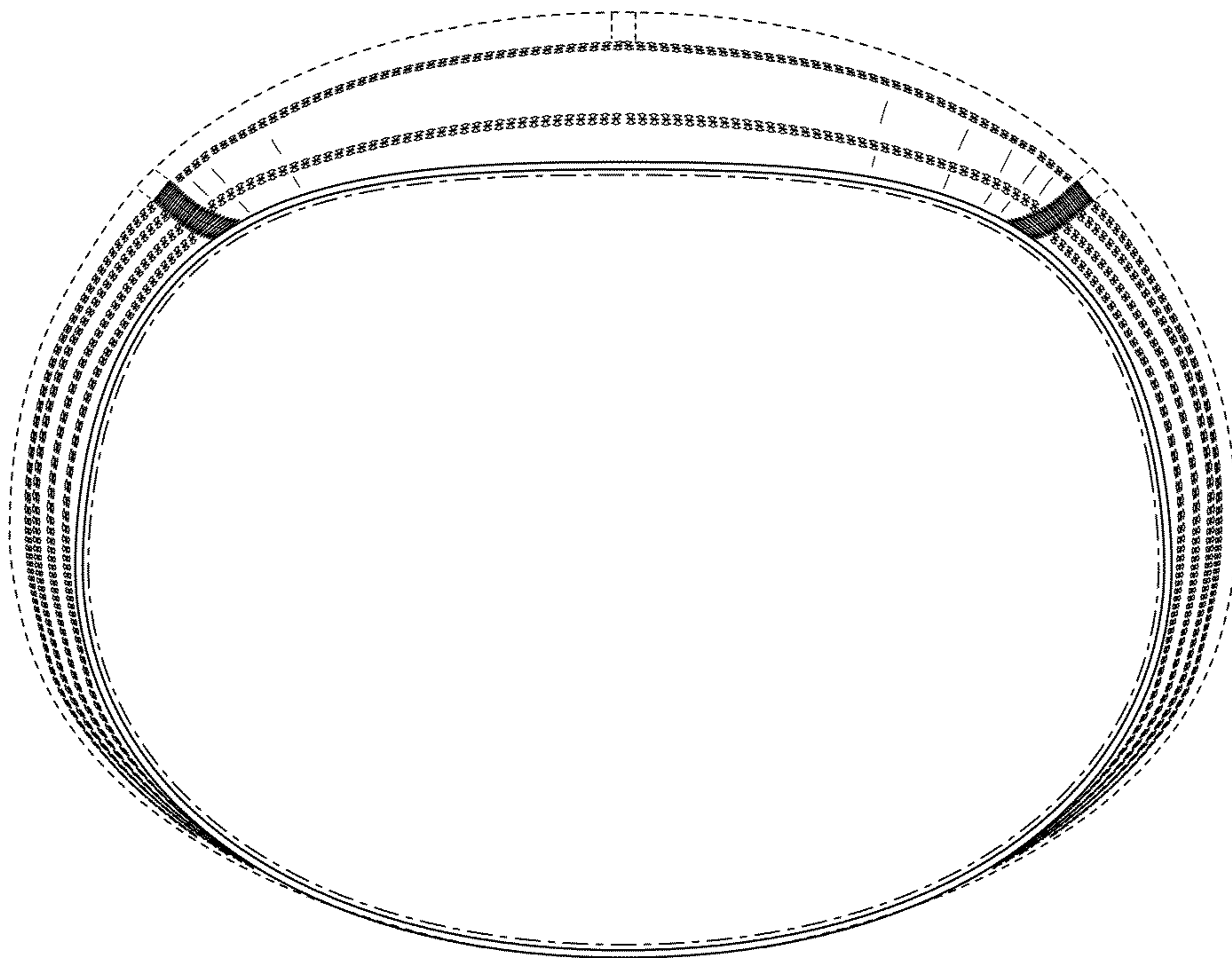

FIG. 6