



US00D686798S

(12) **United States Design Patent**
Sako et al.

(10) **Patent No.:** **US D686,798 S**
(45) **Date of Patent:** **** Jul. 30, 2013**

(54) **PANTS**

(75) Inventors: **Kagari Sako**, Kawasaki (JP); **Takashi Kuraoka**, Koganei (JP); **Shouhei Tamanaha**, Tokyo (JP)

(73) Assignee: **Midori Creative Apparel Co., Ltd.** (JP)

(**) Term: **14 Years**

(21) Appl. No.: **29/404,660**

(22) Filed: **Oct. 24, 2011**

(30) **Foreign Application Priority Data**

Apr. 22, 2011 (JP) D2011-009374

(51) **LOC (9) Cl.** **02-02**

(52) **U.S. Cl.**
USPC **D2/742**

(58) **Field of Classification Search**
USPC D2/712, 713, 731, 732, 737, 738,
D2/742, 853, 857, 983; 2/79, 227, 228,
235-238, 242, 247
See application file for complete search history.

(56) **References Cited**

U.S. PATENT DOCUMENTS

1,037,945 A * 9/1912 Lyles et al. 2/232
1,257,944 A * 2/1918 Knieriem 450/138
D160,221 S * 9/1950 Sinsley D2/712
D275,619 S * 9/1984 Birring D24/126
D284,036 S * 6/1986 Birring D24/126

D568,580 S * 5/2008 Lynch D2/742
D583,050 S * 12/2008 Scott Alston D24/126
D618,435 S * 6/2010 Iamartino et al. D2/742
D660,553 S * 5/2012 Farina et al. D2/742
D668,434 S * 10/2012 Iamartino D2/742
D673,756 S * 1/2013 Agnew et al. D2/742

FOREIGN PATENT DOCUMENTS

JP S53332 1/1978

* cited by examiner

Primary Examiner — Rashida Johnson

(74) *Attorney, Agent, or Firm* — Saidman DesignLaw Group

(57) **CLAIM**

The ornamental design for pants, as shown and described.

DESCRIPTION

FIG. 1 is a rear view of pants showing our new design;
FIG. 2 is a left side view thereof, the right side view being a mirror image;
FIG. 3 is a top plan view thereof;
FIG. 4 is a bottom view thereof;
FIG. 5 is a partial view thereof taken at portion 5-5 in FIG. 1;
FIG. 6 is a cross-sectional view thereof taken along line 6-6 in FIG. 5; and,
FIG. 7 is a front view thereof.
The dot-dash broken lines shown on the drawings illustrate portions of the pants, and the dotted broken lines represent stitching; the broken lines form no part of the claimed design. The crosshatch marks represent a fabric material and are not a surface decoration.

1 Claim, 5 Drawing Sheets

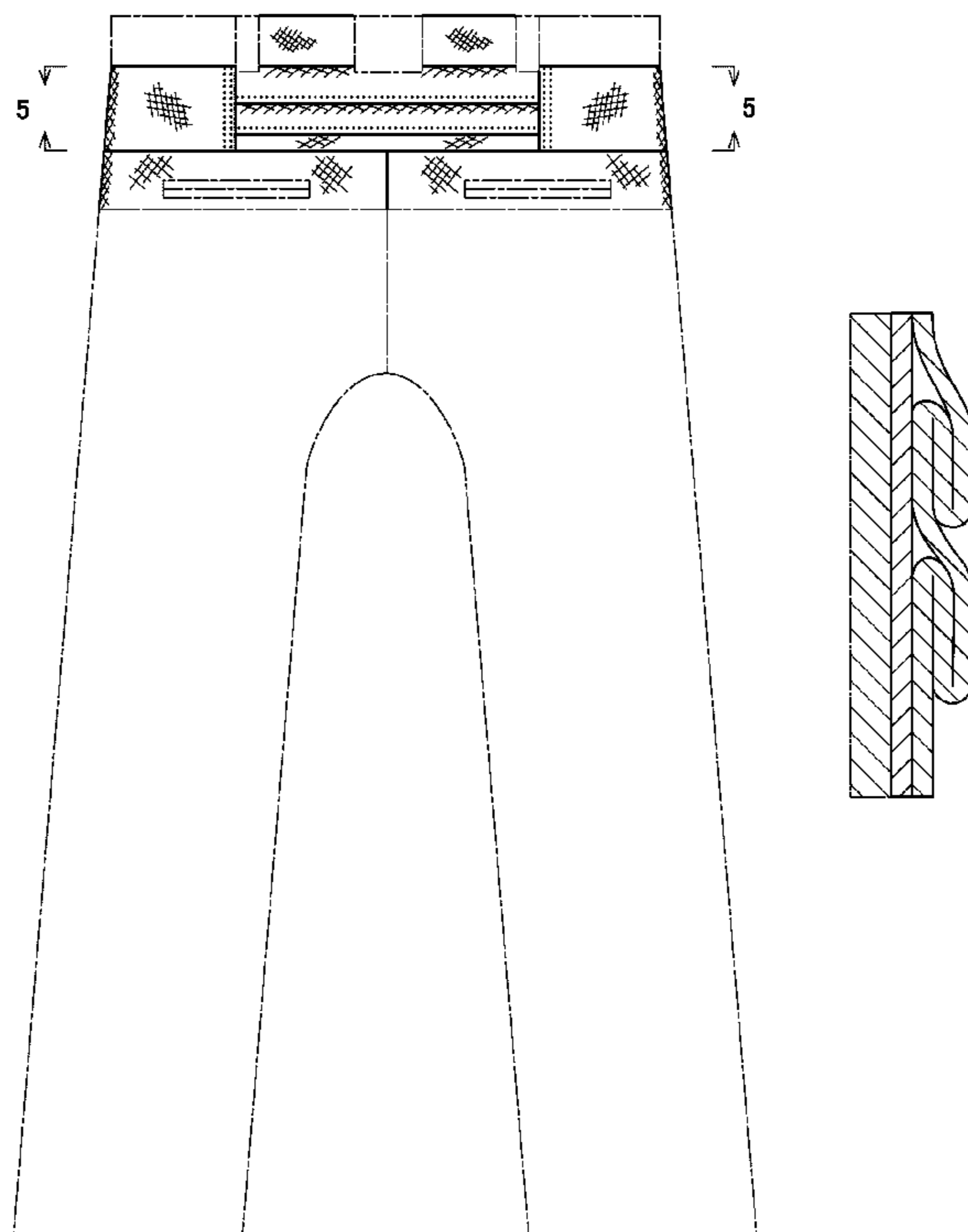

Fig. 1

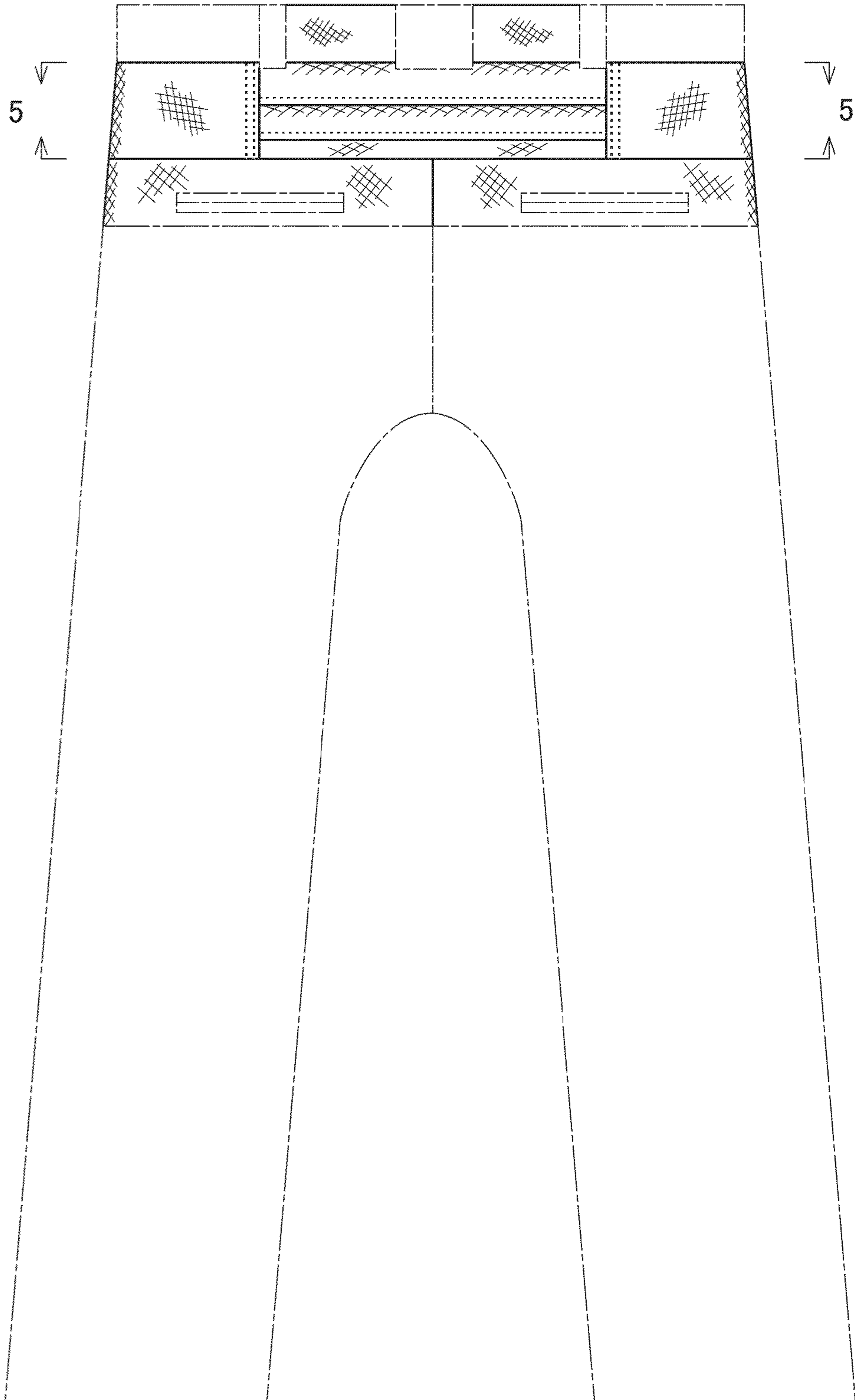

Fig.2

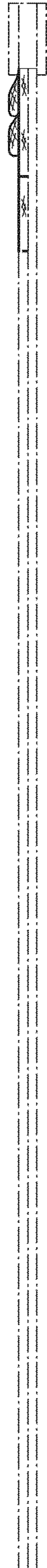

Fig.3

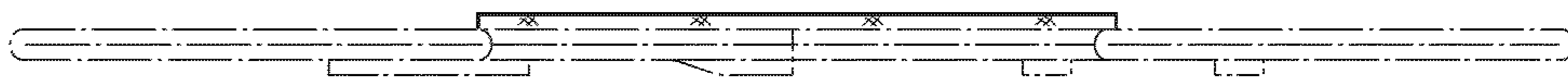
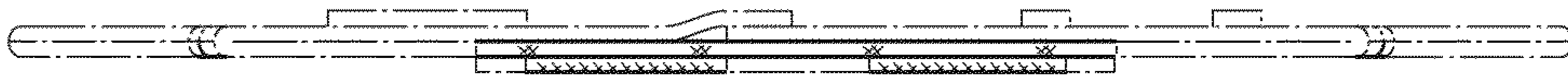

Fig.4

Fig.5

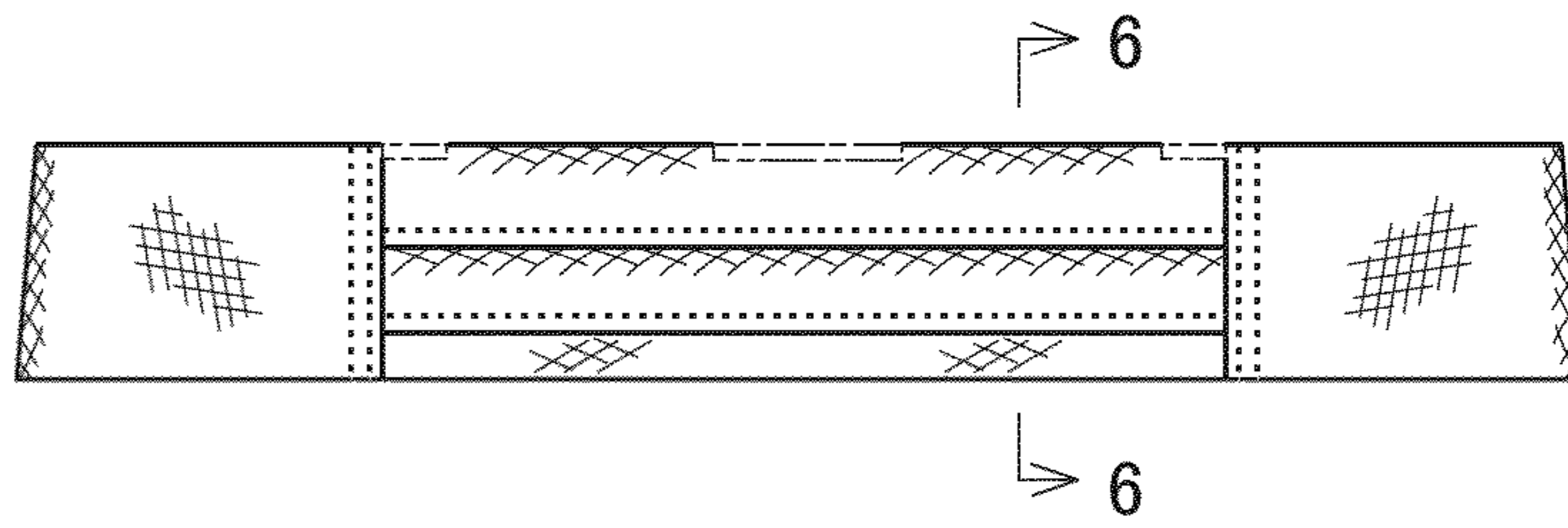

Fig.6

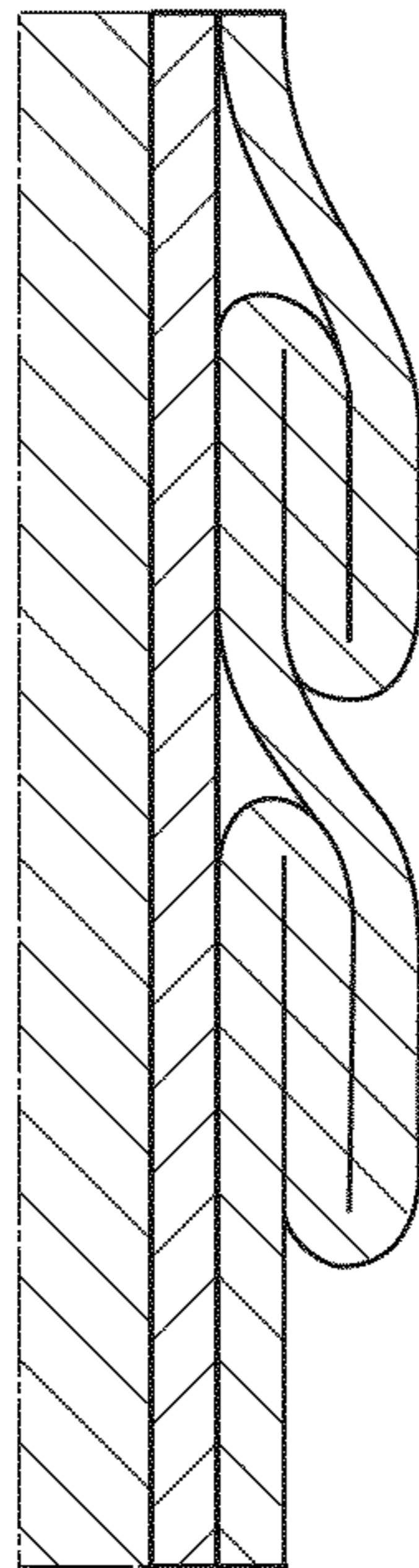

Fig. 7

