



US00D686755S

(12) **United States Design Patent**  
**Ahlander et al.**

(10) **Patent No.:** **US D686,755 S**

(45) **Date of Patent:** **\*\* \*Jul. 23, 2013**

(54) **MOBILE PLATFORM**

(76) Inventors: **James F. Ahlander**, Mesa, AZ (US);  
**Martin Guerrero**, Mesa, AZ (US)

(\* ) Notice: This patent is subject to a terminal disclaimer.

(\*\*) Term: **14 Years**

(21) Appl. No.: **29/385,358**

(22) Filed: **Feb. 11, 2011**

(51) **LOC (9) Cl.** ..... **25-02**

(52) **U.S. Cl.**  
USPC ..... **D25/66**

(58) **Field of Classification Search**  
USPC ..... D25/66; 182/101, 105, 128, 131  
See application file for complete search history.

(56) **References Cited**

**U.S. PATENT DOCUMENTS**

2,750,236	A *	6/1956	Middendorf	.....	182/101
3,910,439	A *	10/1975	Ross et al.	.....	414/503
D403,783	S *	1/1999	Takai	.....	D25/66

\* cited by examiner

*Primary Examiner* — Doris Clark

(74) *Attorney, Agent, or Firm* — Mark F. Wright; Wright Law Group, PLLC

(57) **CLAIM**

The ornamental design for a mobile platform, as shown and described.

**DESCRIPTION**

FIG. 1 is a right side perspective view of a mobile platform in a collapsed orientation showing the new design;  
 FIG. 2 is a rear and left side perspective view of a mobile platform in a collapsed orientation showing the new design;  
 FIG. 3 is a front perspective view of a mobile platform in a collapsed orientation showing the new design;  
 FIG. 4 is a rear perspective view of a mobile platform in a collapsed orientation showing the new design;  
 FIG. 5 is a front and right side perspective view of a mobile platform in an extended orientation showing the new design;  
 FIG. 6 is a top view is a front perspective view of a mobile platform in an extended orientation showing the new design;  
 FIG. 7 is a front and left side perspective view of a mobile platform in an extended orientation showing the new design;  
 and,  
 FIG. 8 is a rear and right side perspective view of a mobile platform in an extended orientation showing the new design.

**1 Claim, 8 Drawing Sheets**

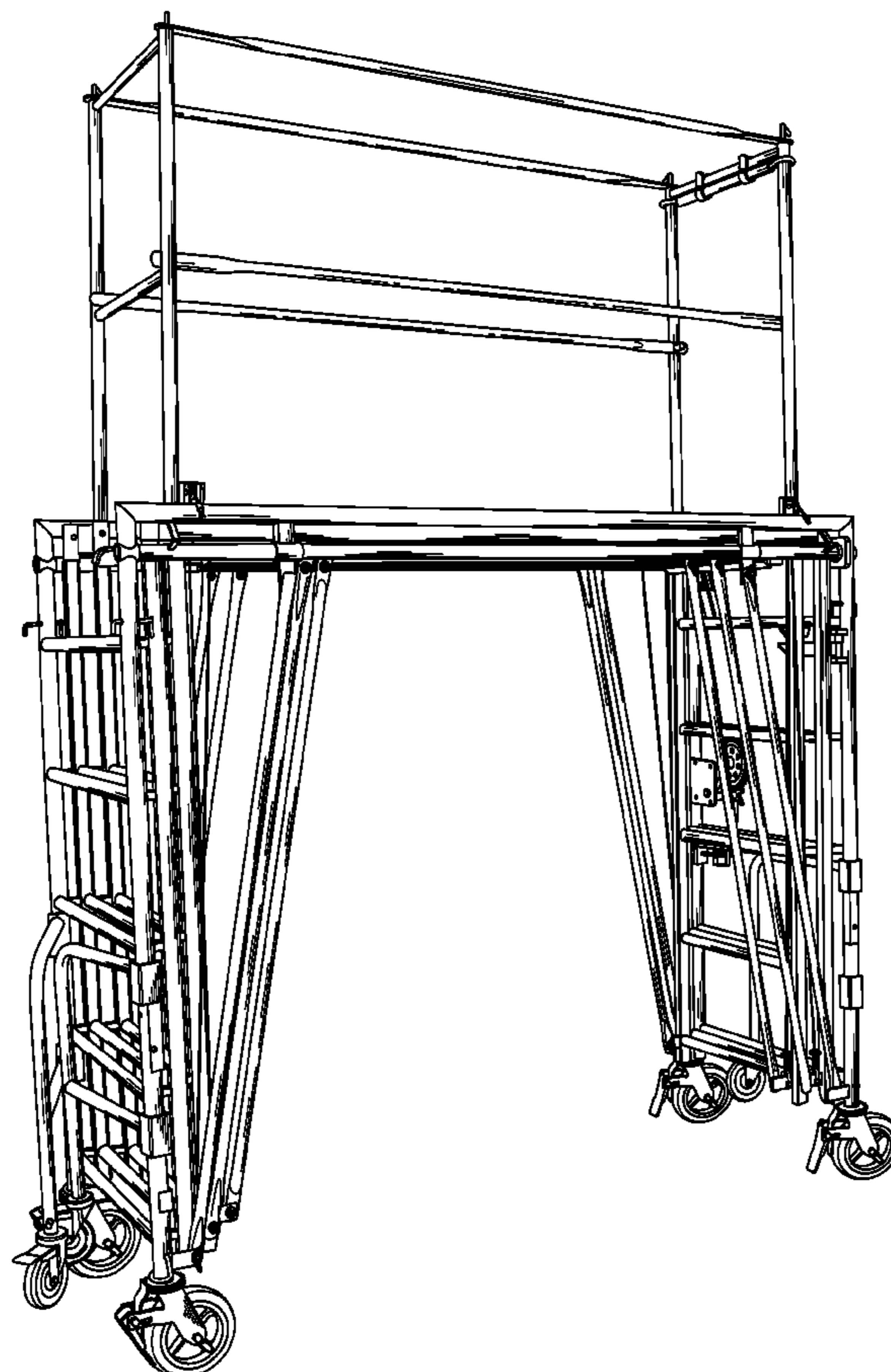

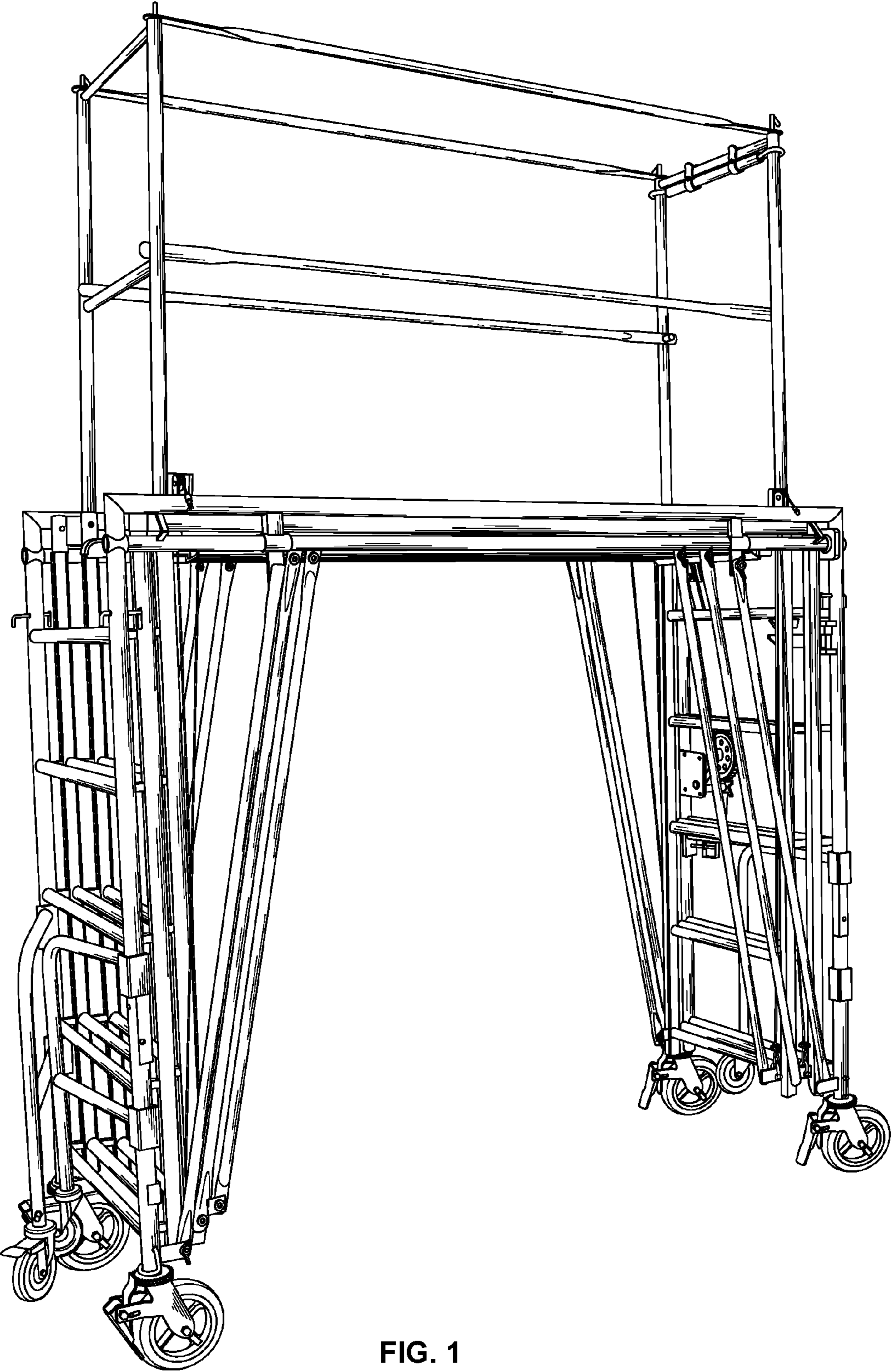

FIG. 1

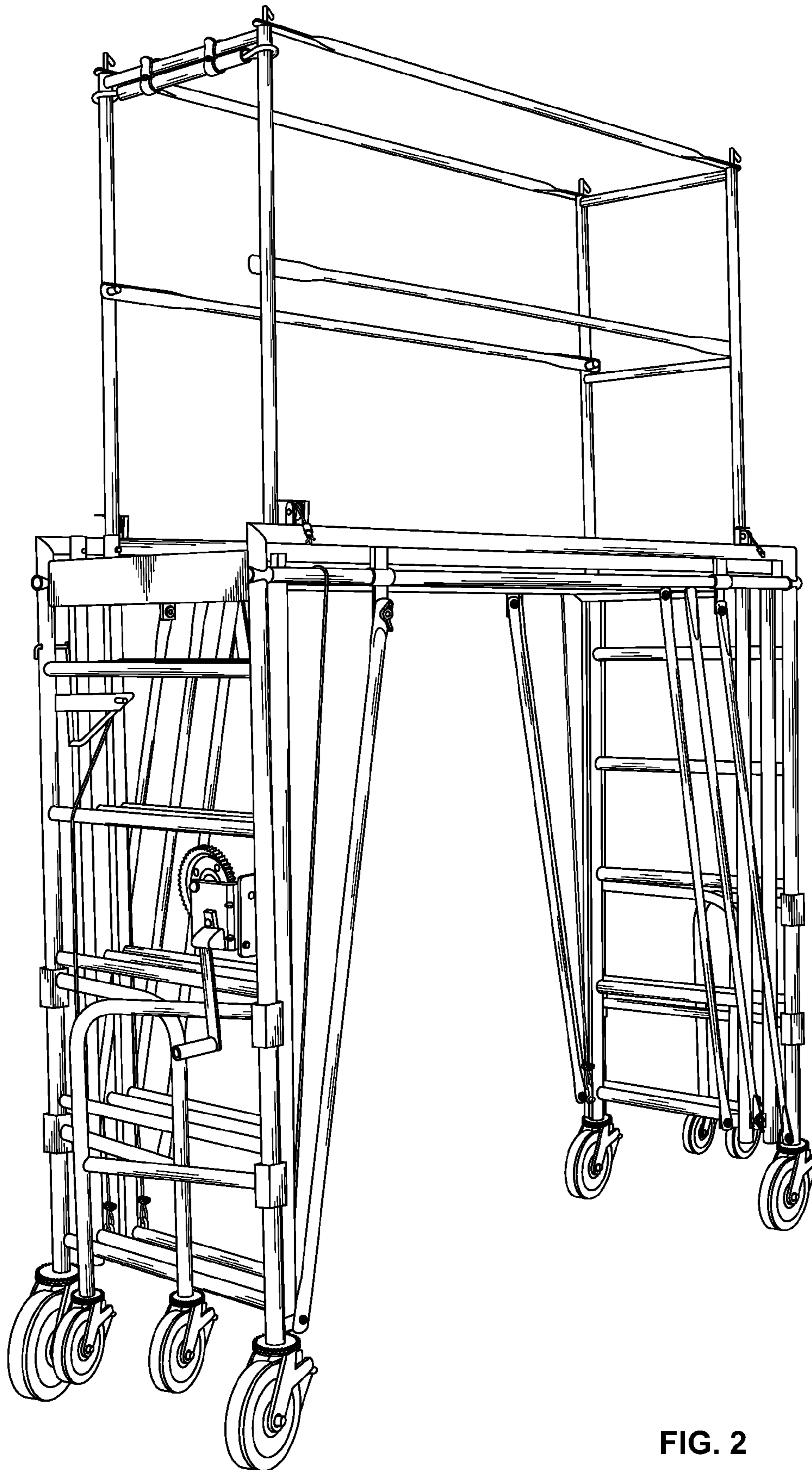

FIG. 2

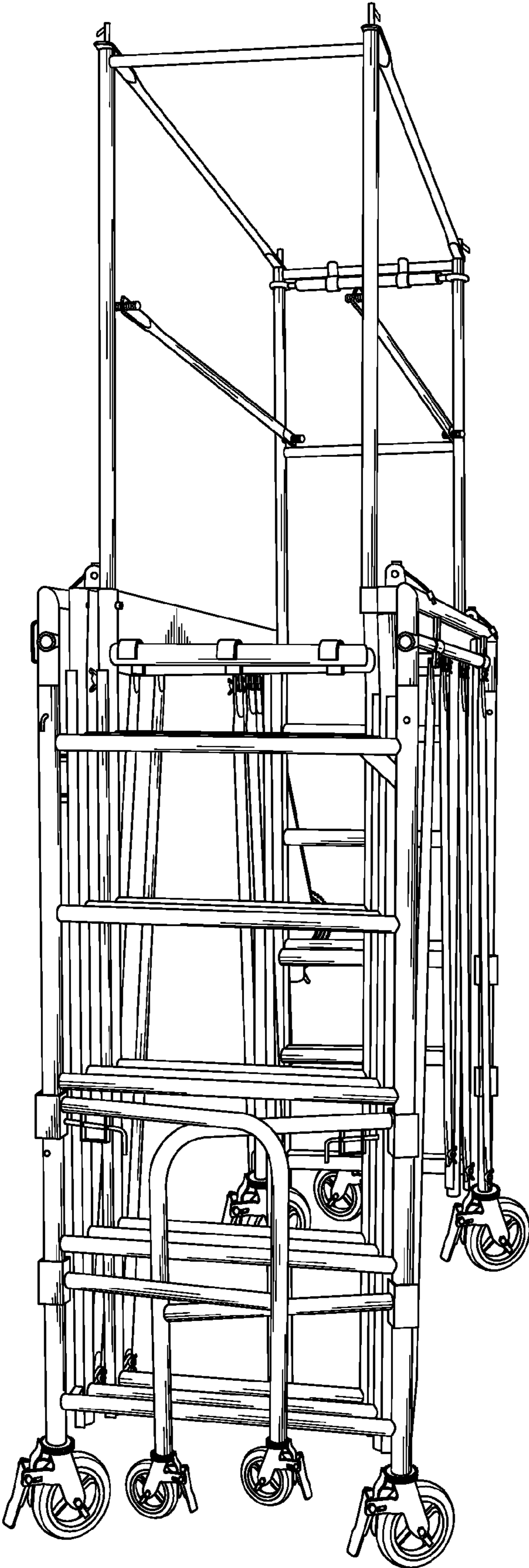

FIG. 3



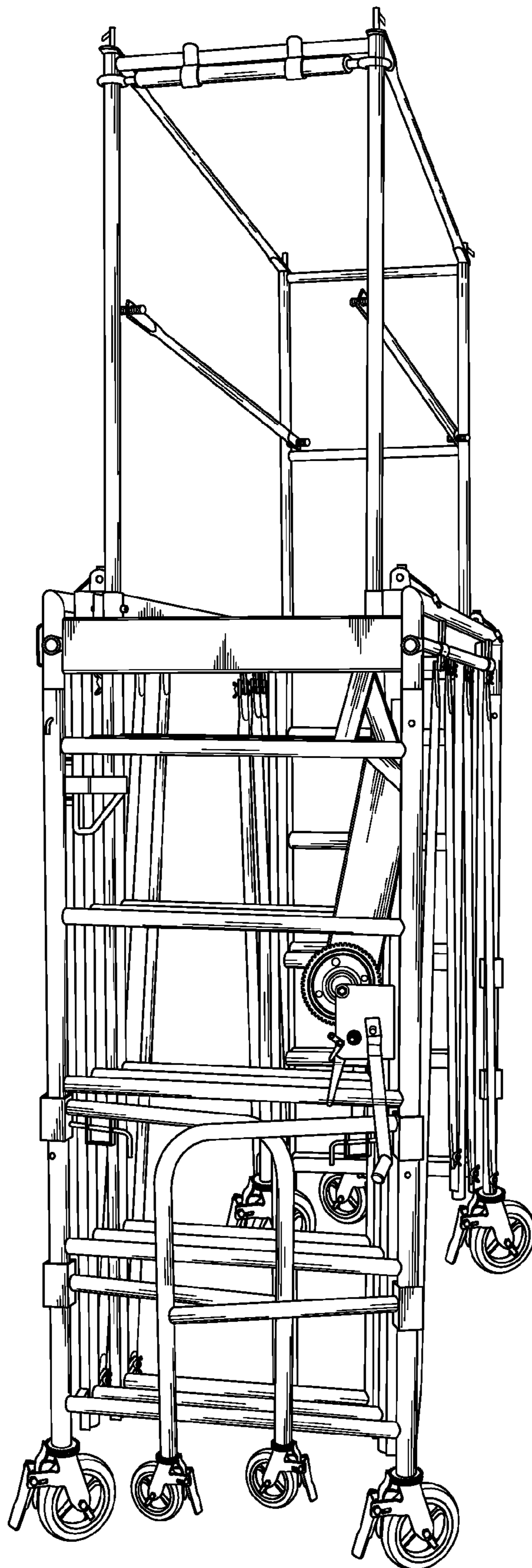

FIG. 4

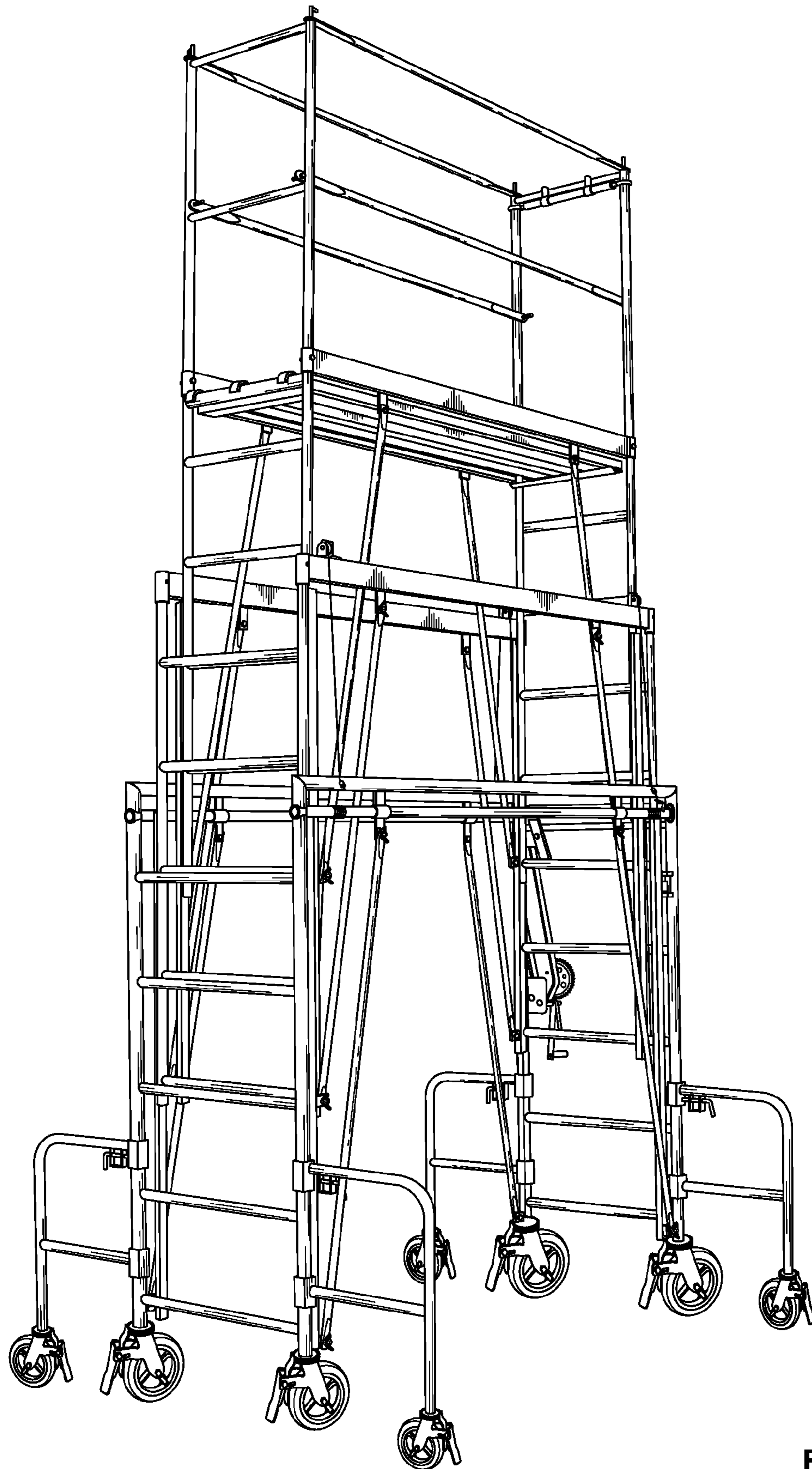

FIG. 5

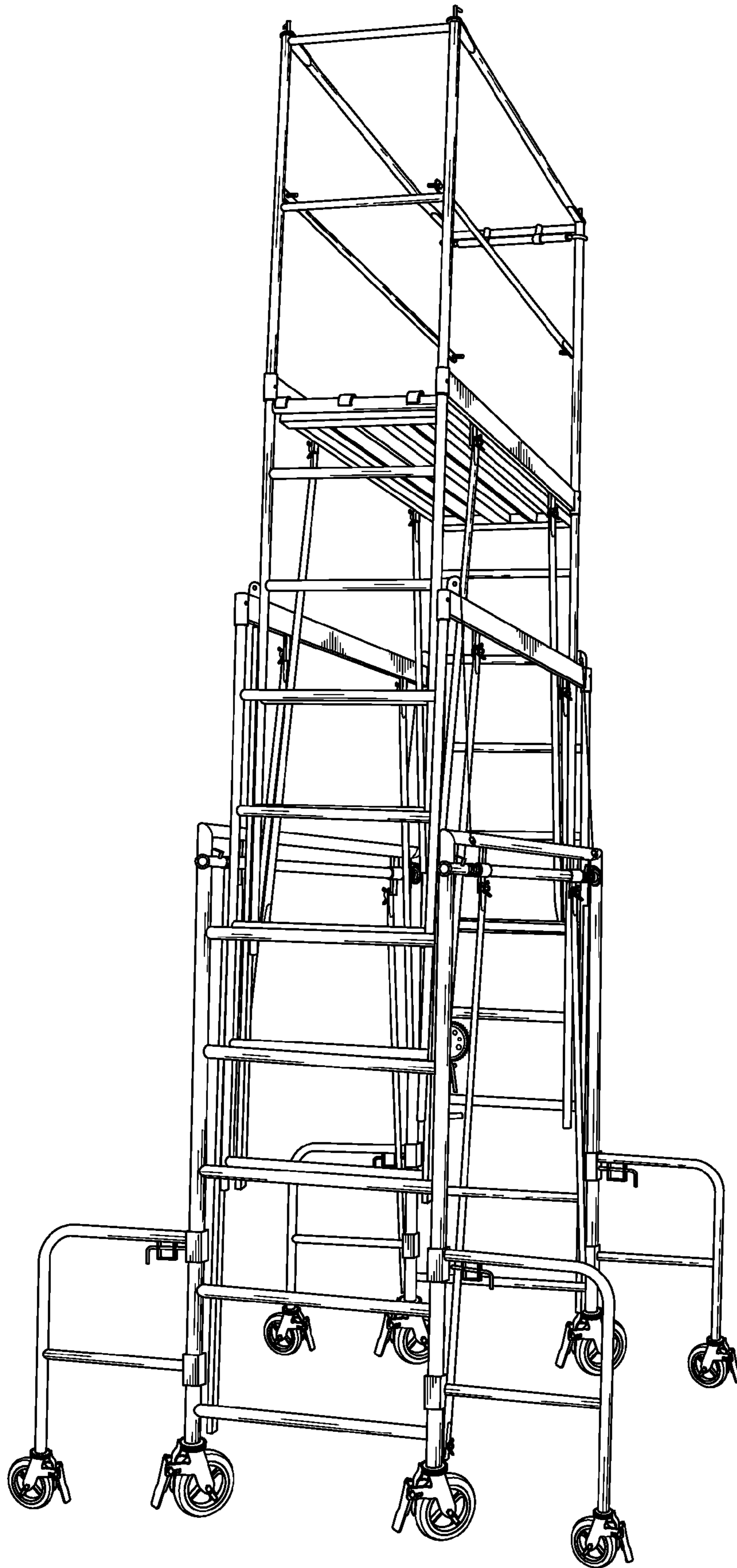

FIG. 6

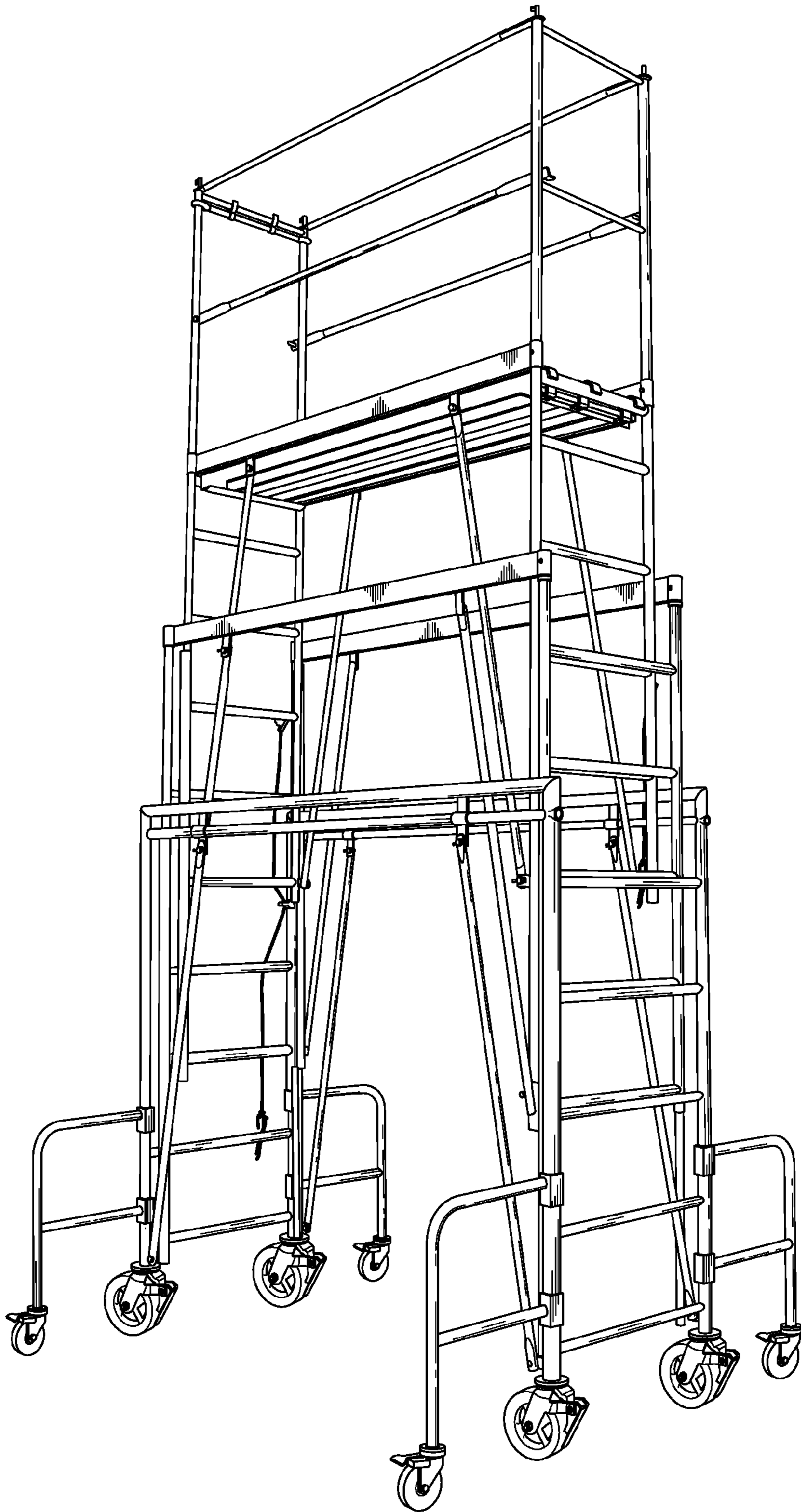

FIG. 7



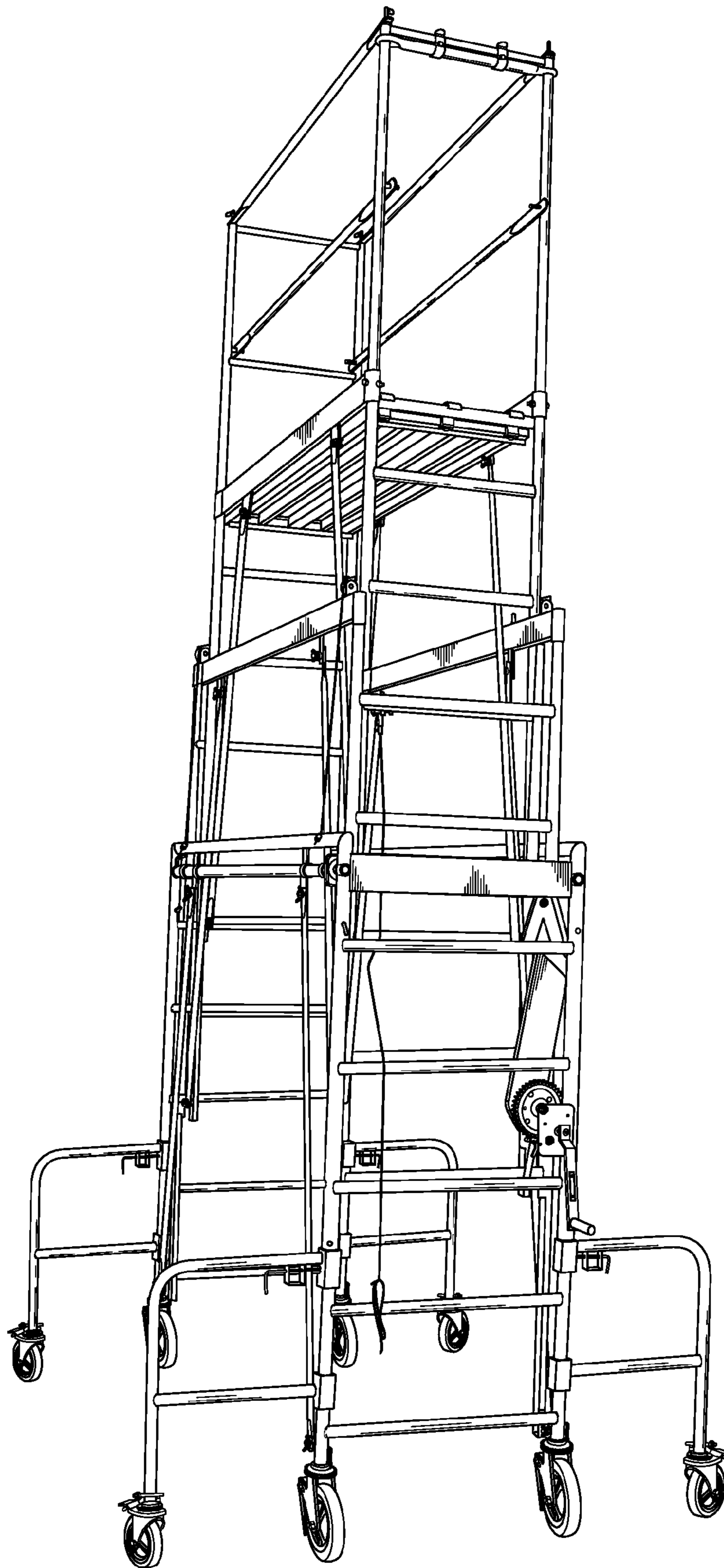

FIG. 8