

US00D686741S

(12) **United States Design Patent**
Boonprasop

(10) **Patent No.:** **US D686,741 S**
(45) **Date of Patent:** **** Jul. 23, 2013**

- (54) **BOTTLE**
- (75) Inventor: **Pruck Boonprasop**, Bangkok (TH)
- (73) Assignee: **Magic Love Limited**, Wanchai (HK)
- (**) Term: **14 Years**
- (21) Appl. No.: **29/402,382**
- (22) Filed: **Sep. 22, 2011**
- (51) **LOC (9) Cl.** **07-01**
- (52) **U.S. Cl.**
USPC **D24/197**
- (58) **Field of Classification Search**
USPC D24/193, 196, 197, 198; D7/509–511,
D7/516, 533–534; D9/500, 502–504, 516,
D9/538–540, 542, 551; 215/11.1–11.6, 381,
215/396; 220/288, 710.5
See application file for complete search history.

- D498,419 S 11/2004 Martin
- D501,133 S 1/2005 Schuller et al.
- D504,614 S 5/2005 Schuller et al.
- D511,836 S * 11/2005 Morano et al. D24/197
- D513,185 S 12/2005 Ruiz
- D514,945 S 2/2006 Busa, Jr. et al.
- D522,372 S 6/2006 Wang et al.
- D533,064 S 12/2006 Glynn et al.
- D533,069 S 12/2006 Archeny
- D565,422 S 4/2008 Cowan-Hughes et al.
- D577,958 S * 10/2008 Homma D7/510
- D580,764 S * 11/2008 Shale D9/500
- D590,267 S 4/2009 Oommen et al.

(Continued)

OTHER PUBLICATIONS

Co-pending U.S. Appl. No. 29/402,377, inventor Boonprasop, P., filed Sep. 22, 2011 (Not Published).

(Continued)

Primary Examiner — Susan E Krakower
(74) *Attorney, Agent, or Firm* — Sterne, Kessler, Goldstein & Fox P.L.L.C.

(56) **References Cited**

U.S. PATENT DOCUMENTS

- D195,368 S 6/1963 Koenigsberg
- D208,116 S 7/1967 Landor
- D210,571 S 3/1968 Vanderhyde
- D301,741 S * 6/1989 Barber D24/197
- D356,160 S * 3/1995 Cautereels D24/197
- D362,188 S 9/1995 Van Dyk
- D365,021 S 12/1995 Park
- D382,811 S 8/1997 Kotyuk, Jr. et al.
- D398,519 S 9/1998 Keene
- D420,448 S * 2/2000 Brown et al. D24/197
- D423,107 S * 4/2000 Brown et al. D24/197
- D437,229 S 2/2001 Andrew
- D447,693 S 9/2001 Warner et al.
- D460,560 S * 7/2002 Chomik et al. D24/197
- D478,669 S * 8/2003 Wear D24/197
- D482,571 S 11/2003 Leinenweber
- D483,611 S * 12/2003 Diak Ghanem D7/523
- D496,283 S 9/2004 Busa, Jr.
- D496,733 S * 9/2004 Morano et al. D24/197

(57) **CLAIM**

The ornamental design for a bottle, as shown and described.

DESCRIPTION

FIG. 1 is a front perspective view of a bottle showing my new design;
FIG. 2 is a front view thereof;
FIG. 3 is a rear view thereof;
FIG. 4 is a right side view thereof;
FIG. 5 is a left side view thereof;
FIG. 6 is a top plan view thereof; and,
FIG. 7 is a bottom plan view thereof.
The broken lines in FIGS. 1, 6, and 7 show portions of the bottle which form no part of the claimed design.

1 Claim, 7 Drawing Sheets

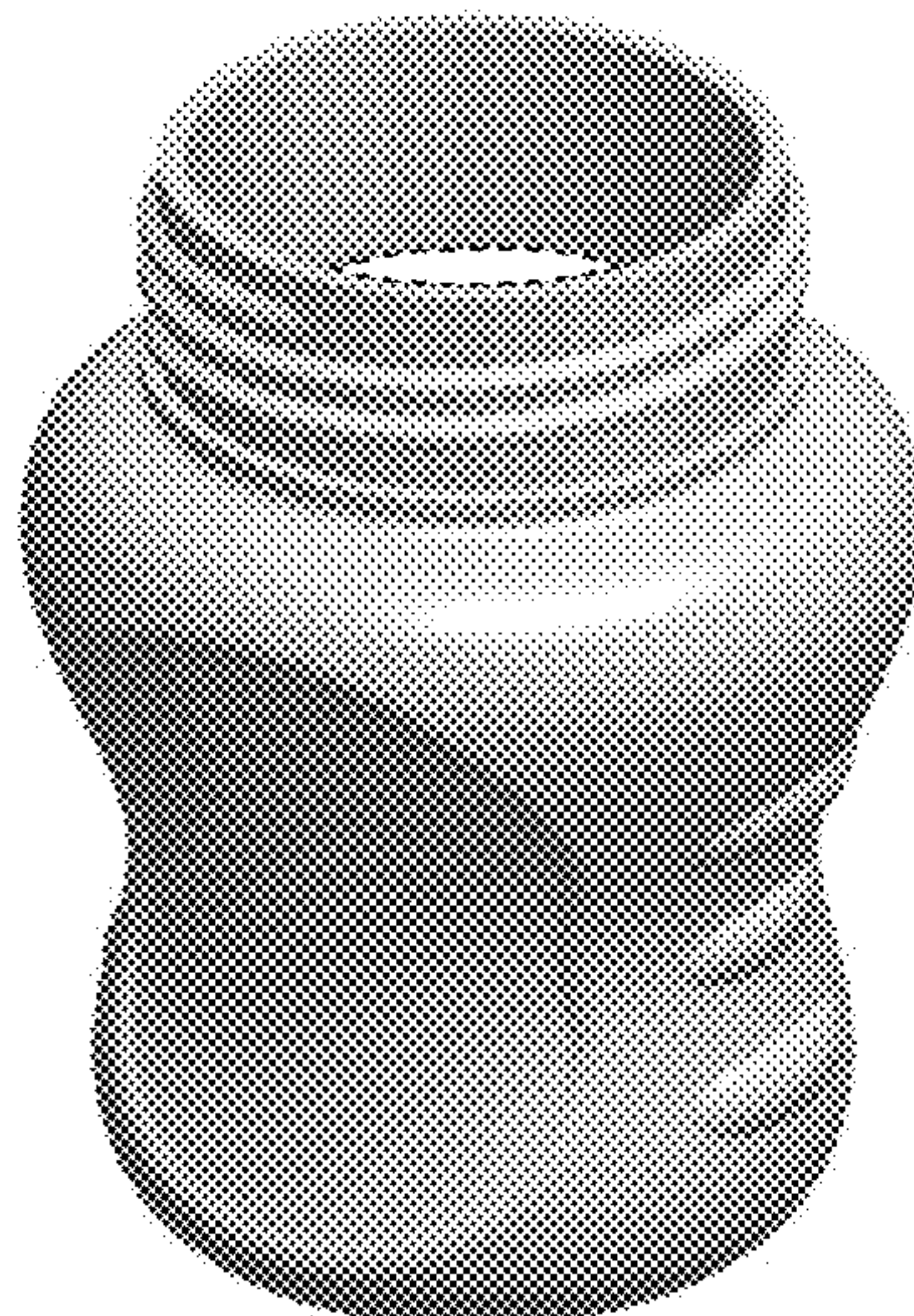

US D686,741 S

Page 2

U.S. PATENT DOCUMENTS

D592,523 S 5/2009 Padain et al.
D594,333 S 6/2009 Casey et al.
D594,334 S 6/2009 Casey et al.
D596,501 S * 7/2009 Diss et al. D9/776
D596,502 S * 7/2009 Diss et al. D9/776
7,568,588 B2 * 8/2009 Yourist 215/381
D612,250 S * 3/2010 Shah D9/538
D620,315 S * 7/2010 Boonprasop D7/509
D625,423 S * 10/2010 MacKay et al. D24/197
D626,849 S * 11/2010 Wilson et al. D9/538
D627,598 S * 11/2010 Boonprasop D7/509
D628,078 S * 11/2010 Valderrama et al. D9/542

D641,887 S * 7/2011 Sirota D24/197
D642,436 S * 8/2011 Schofield et al. D7/510
D642,437 S * 8/2011 Schofield et al. D7/510
D642,438 S * 8/2011 Schofield et al. D7/510
D648,857 S * 11/2011 Pheil et al. D24/197
D666,874 S * 9/2012 Sakulsacha D7/510

OTHER PUBLICATIONS

Co-pending U.S. Appl. No. 29/402,379, inventor Boonprasop, P.,
filed Sep. 22, 2011 (Not Published).

* cited by examiner

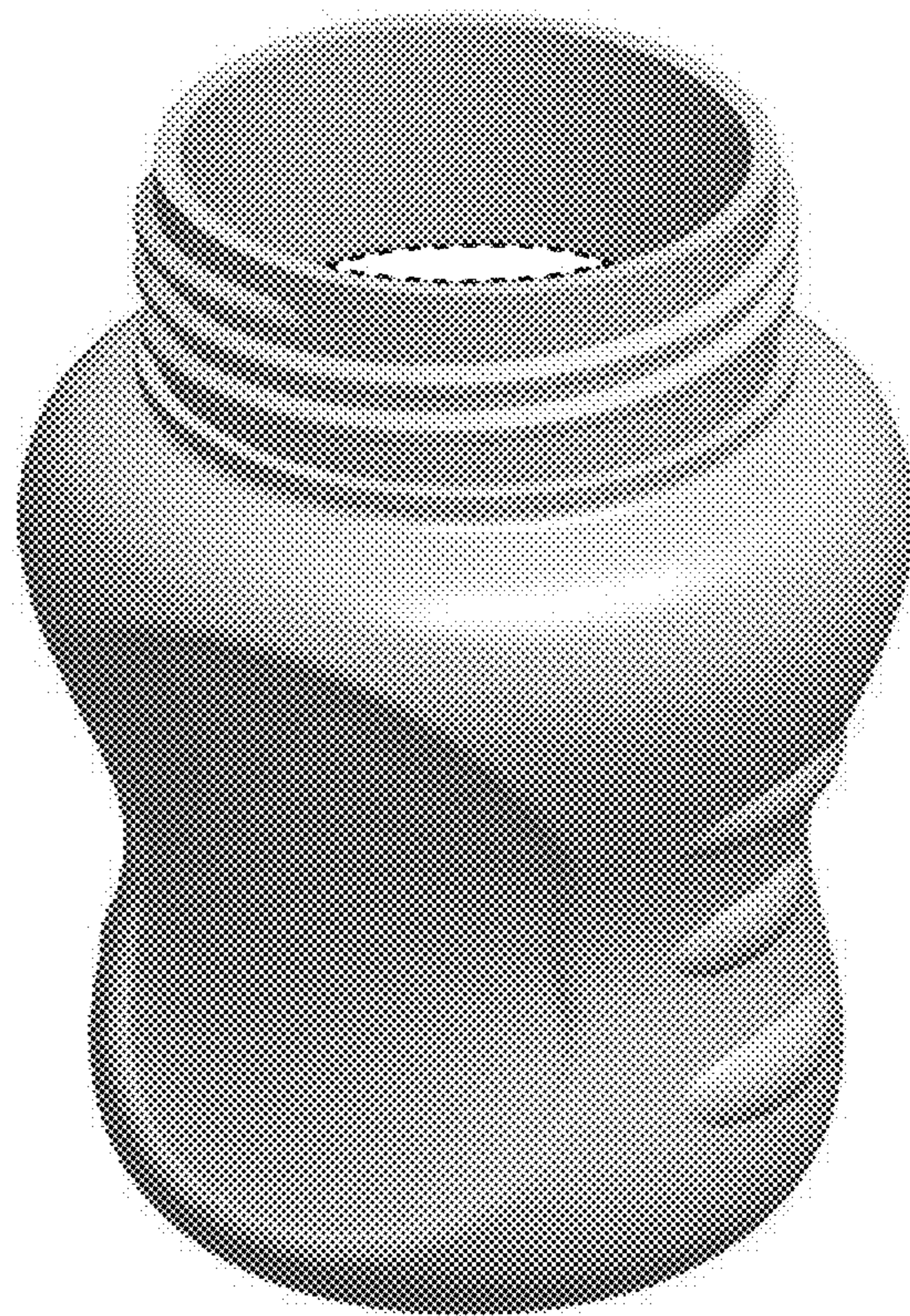

FIG. 1



FIG. 2

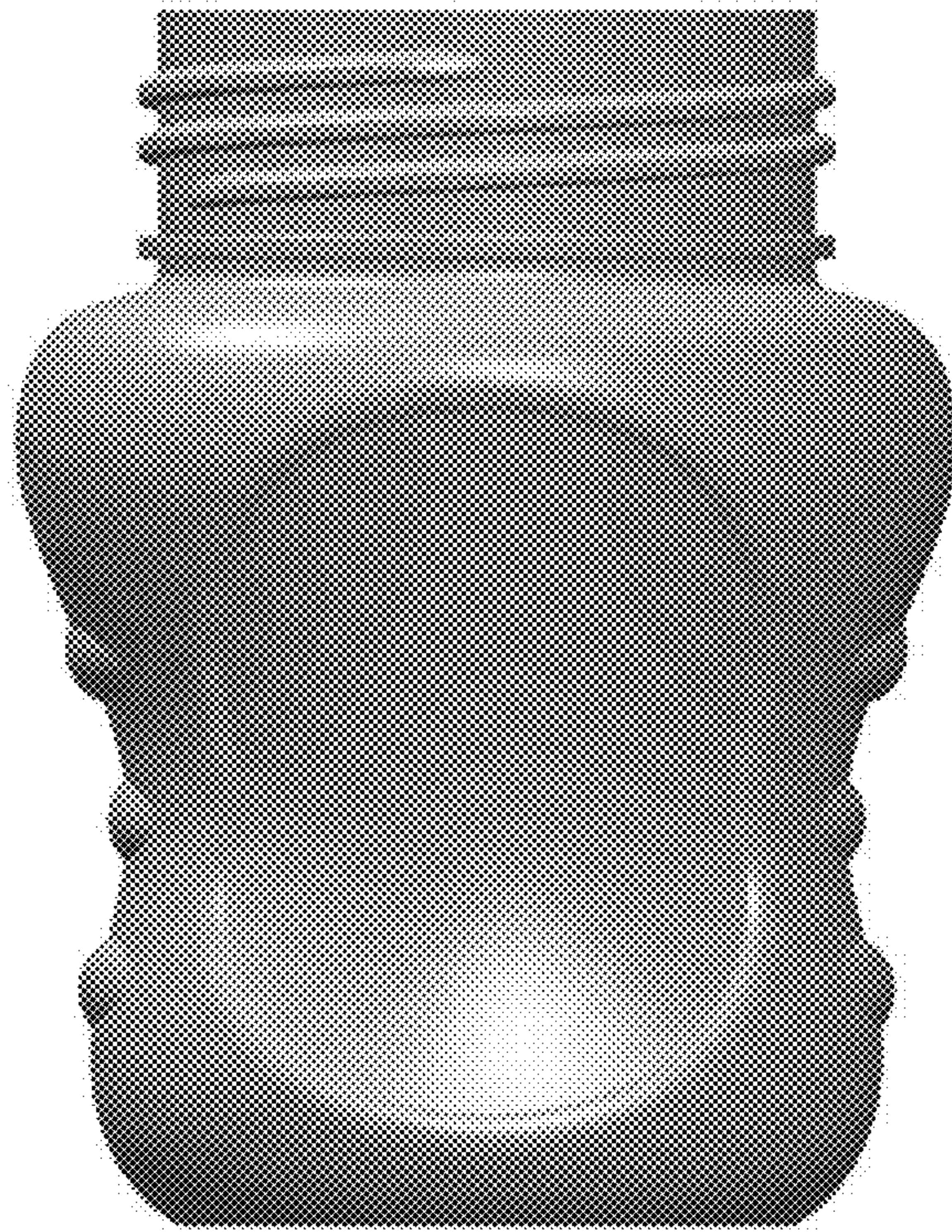

FIG. 3

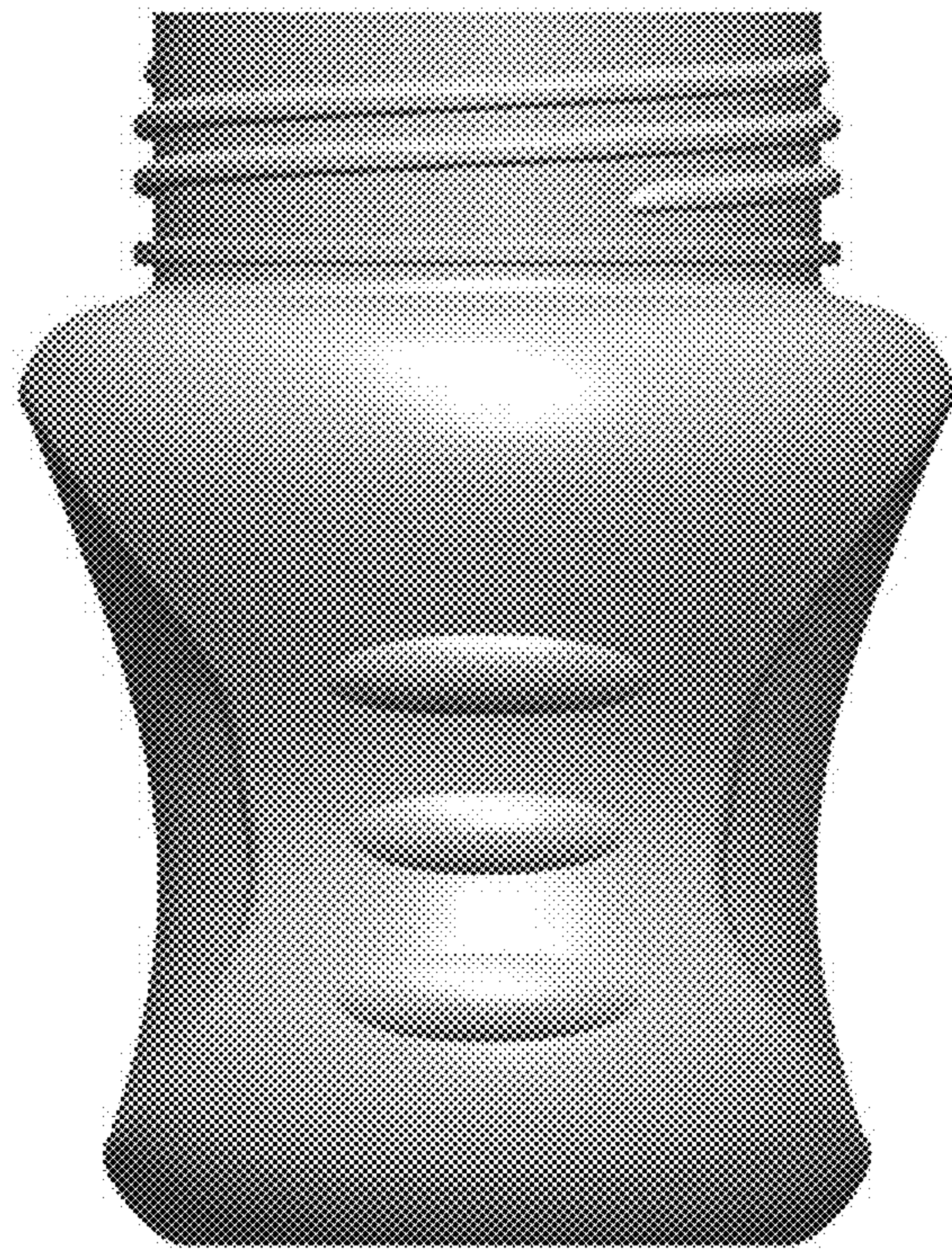

FIG. 4

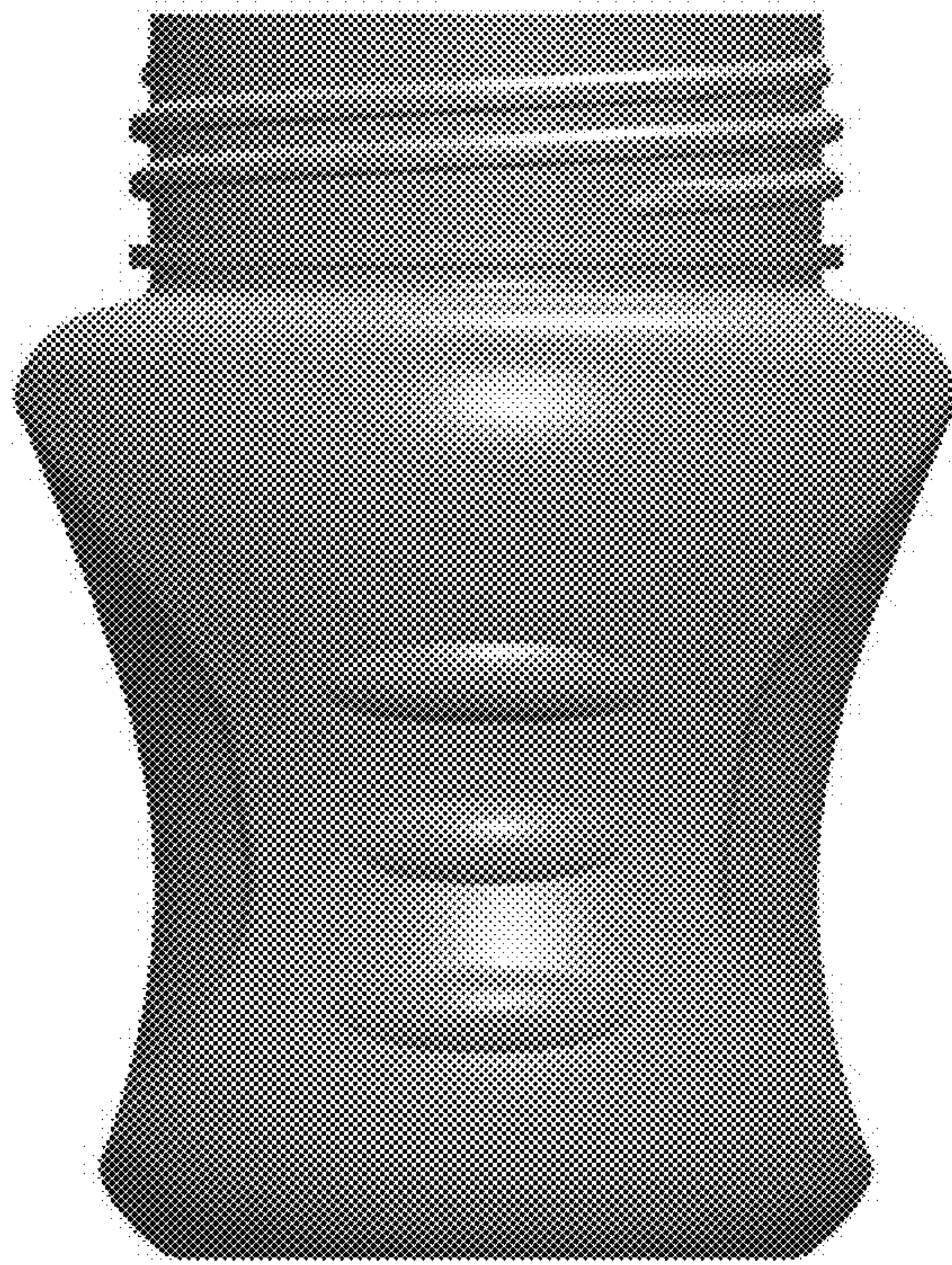

FIG. 5

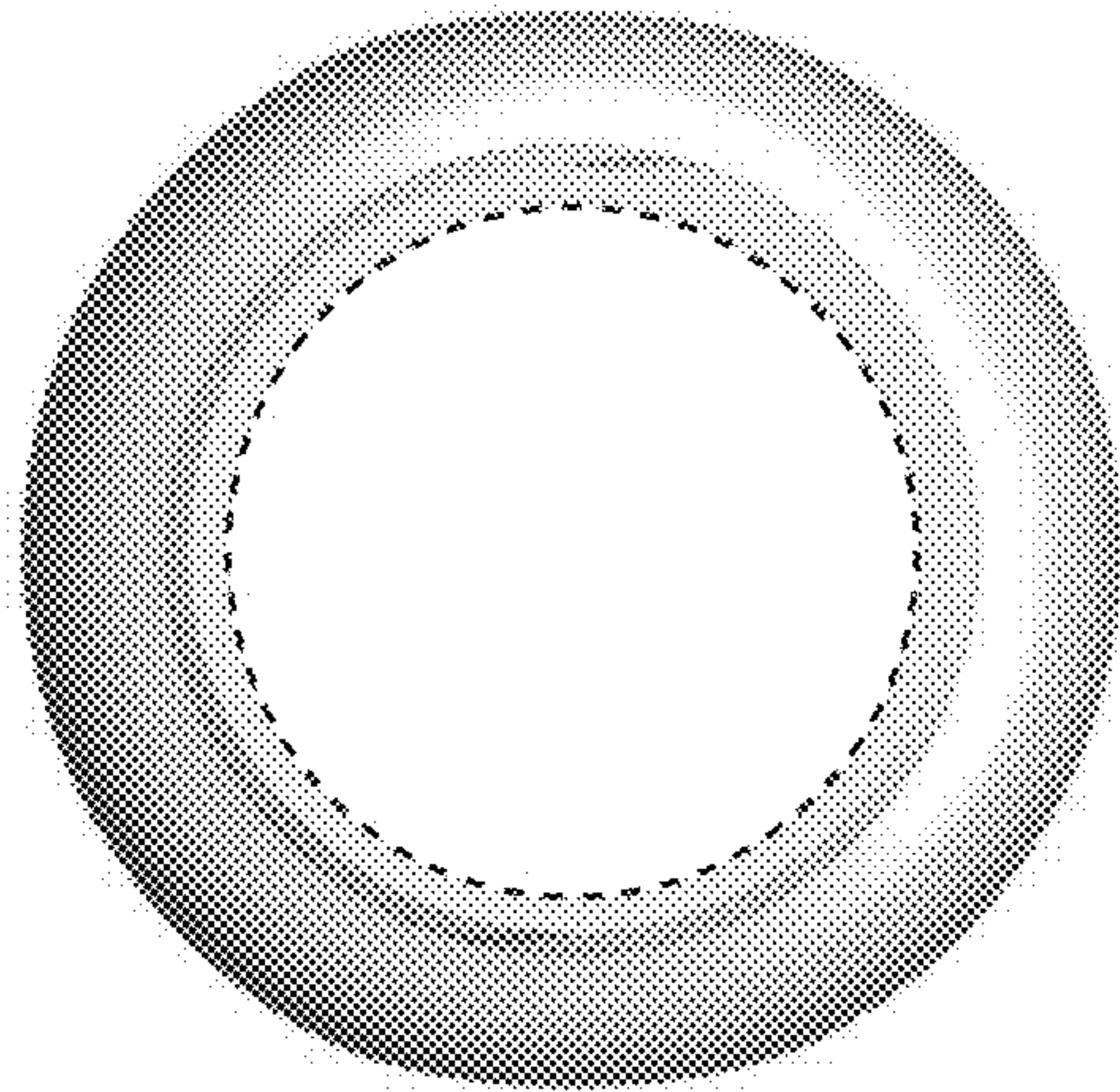

FIG. 6

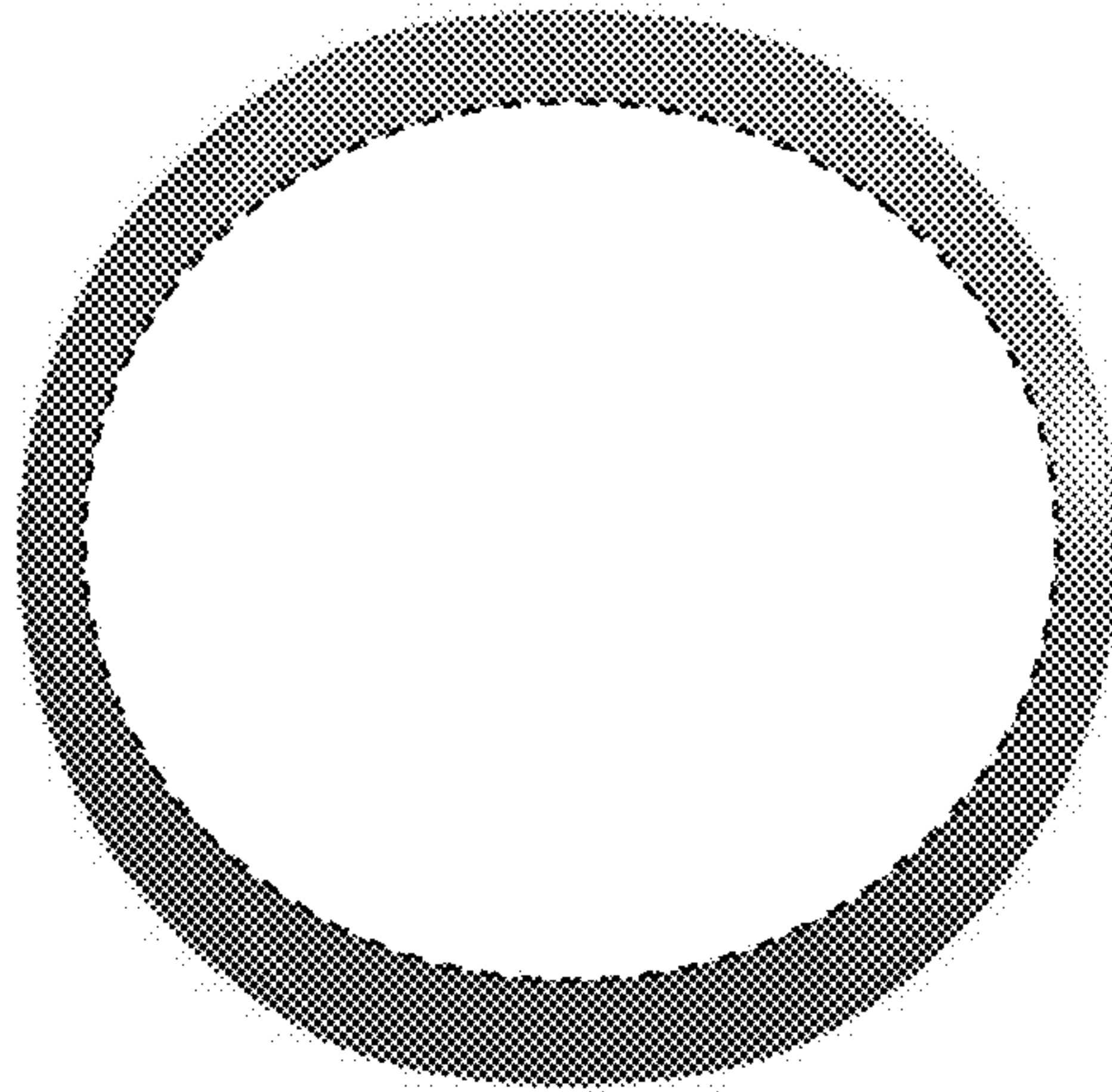

FIG. 7