



US00D686716S

(12) **United States Design Patent**
Smith

(10) **Patent No.:** **US D686,716 S**

(45) **Date of Patent:** **** Jul. 23, 2013**

- (54) **MOBILE RADIANT HEATER**
- (71) Applicant: **Bromic Pty Ltd.**, New South Wales (AU)
- (72) Inventor: **Scott Smith**, Silverwater (AU)
- (73) Assignee: **Bromic Pty. Ltd.** (AU)
- (**) Term: **14 Years**
- (21) Appl. No.: **29/439,853**
- (22) Filed: **Dec. 17, 2012**
- (51) **LOC (9) Cl.** **23-03**
- (52) **U.S. Cl.**
USPC **D23/332; D23/317**
- (58) **Field of Classification Search**
USPC D23/323, 328, 332, 336, 339, 342,
D23/386, 338, 314, 317; 126/25 R, 67, 92 A,
126/92 B, 9 A; 362/92, 217, 253; 431/331,
431/344
See application file for complete search history.

- D619,231 S * 7/2010 Yeung D23/317
- D627,450 S * 11/2010 Hall et al. D23/332
- D627,451 S * 11/2010 Hall et al. D23/332
- D627,868 S * 11/2010 Hall et al. D23/332
- D654,577 S * 2/2012 Smith et al. D23/332
- D654,579 S * 2/2012 Smith et al. D23/342
- 2006/0198084 A1 * 9/2006 Hall et al. 361/600

* cited by examiner

Primary Examiner — T. Chase Nelson

Assistant Examiner — Ania Aman

(74) *Attorney, Agent, or Firm* — Skinner and Associates

(57) **CLAIM**

The ornamental design for a mobile radiant heater, as shown and described.

DESCRIPTION

FIG. 1 is a perspective view of a mobile radiant heater showing the design of this invention.

FIG. 2 is a front view.

FIG. 3 is a top view thereof.

FIG. 4 is a right side view thereof.

FIG. 5 is a left side view thereof.

FIG. 6 is a rear view thereof; and,

FIG. 7 is a bottom view thereof.

(56) **References Cited**

U.S. PATENT DOCUMENTS

- D325,963 S * 5/1992 Anderson D23/342
- D532,500 S * 11/2006 Yeung D23/339
- D608,431 S * 1/2010 Wang D23/332

1 Claim, 6 Drawing Sheets

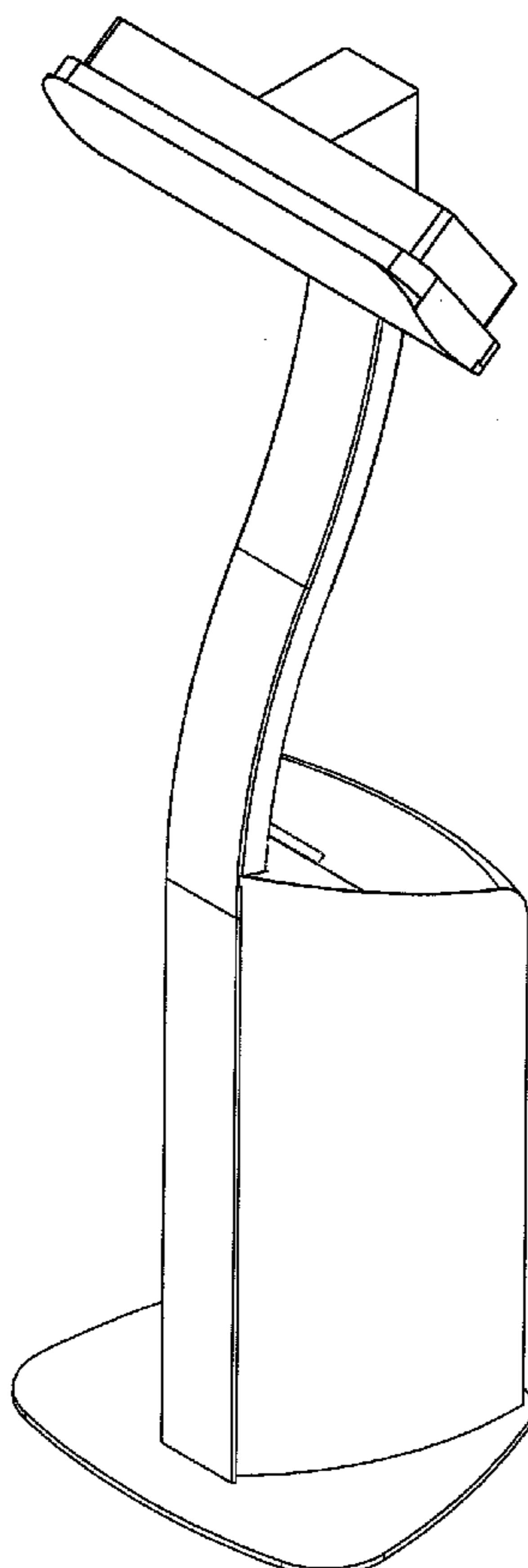

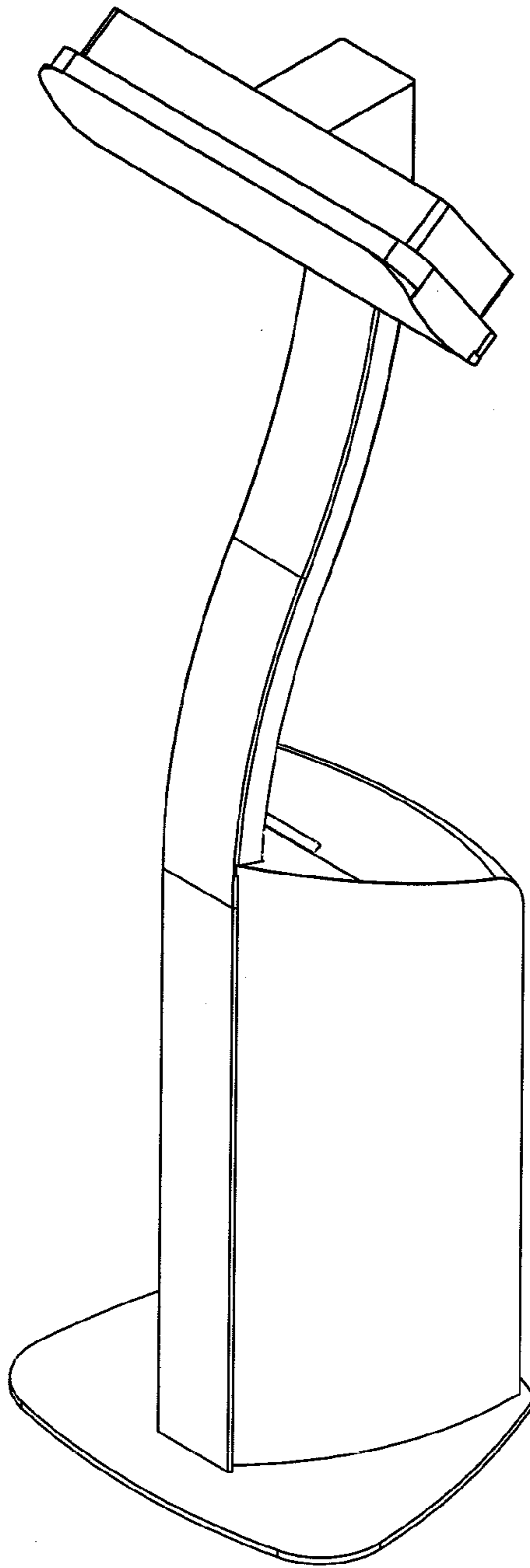

FIGURE 1

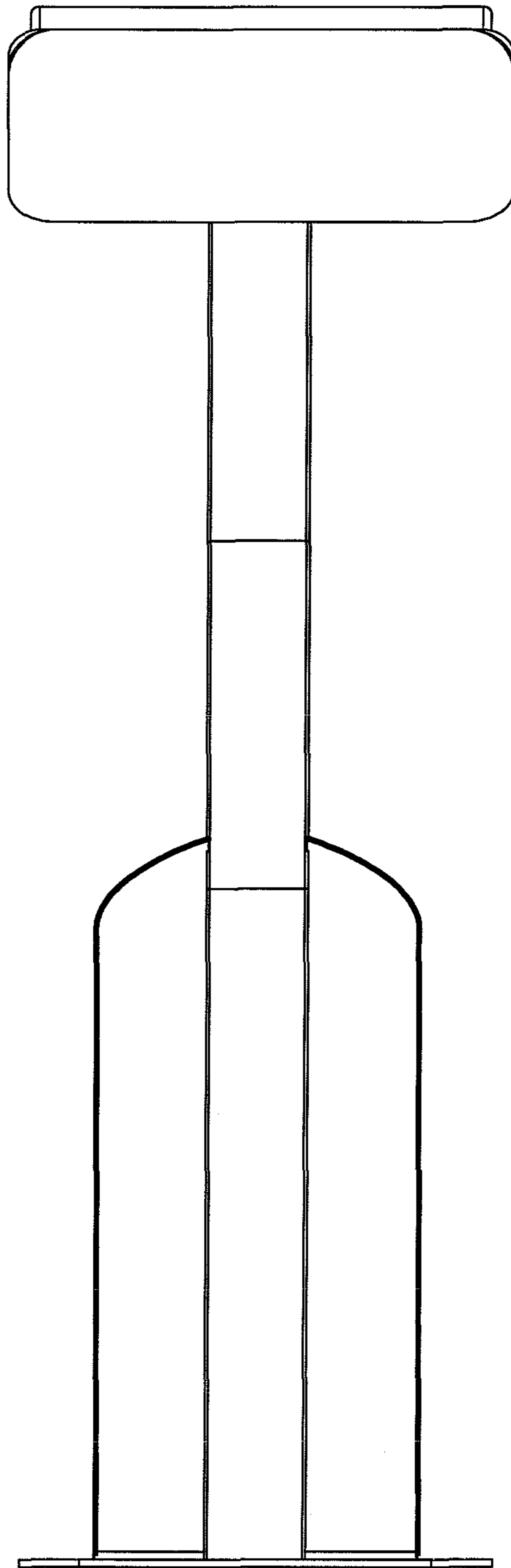

FIGURE 2

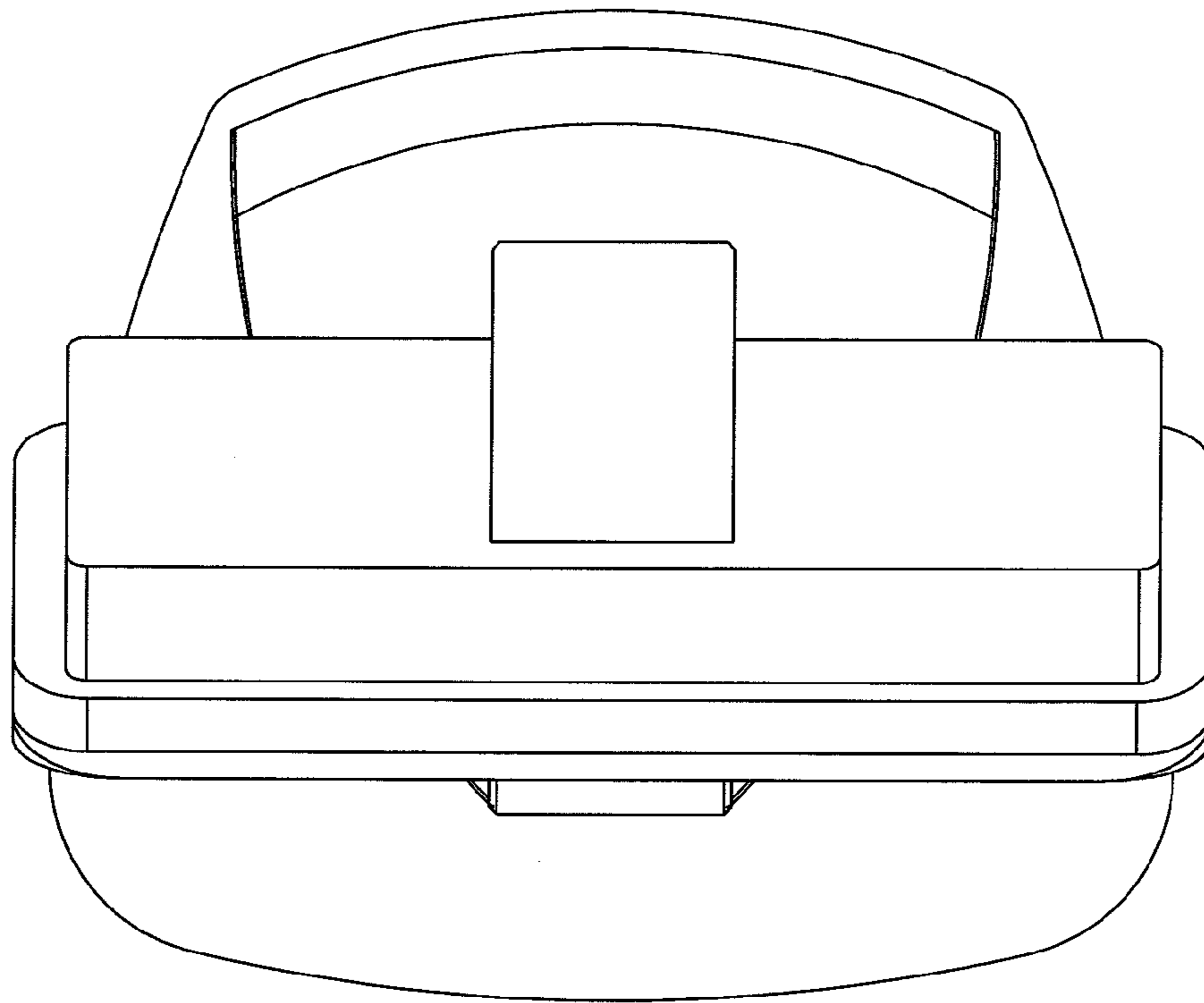

FIGURE 3

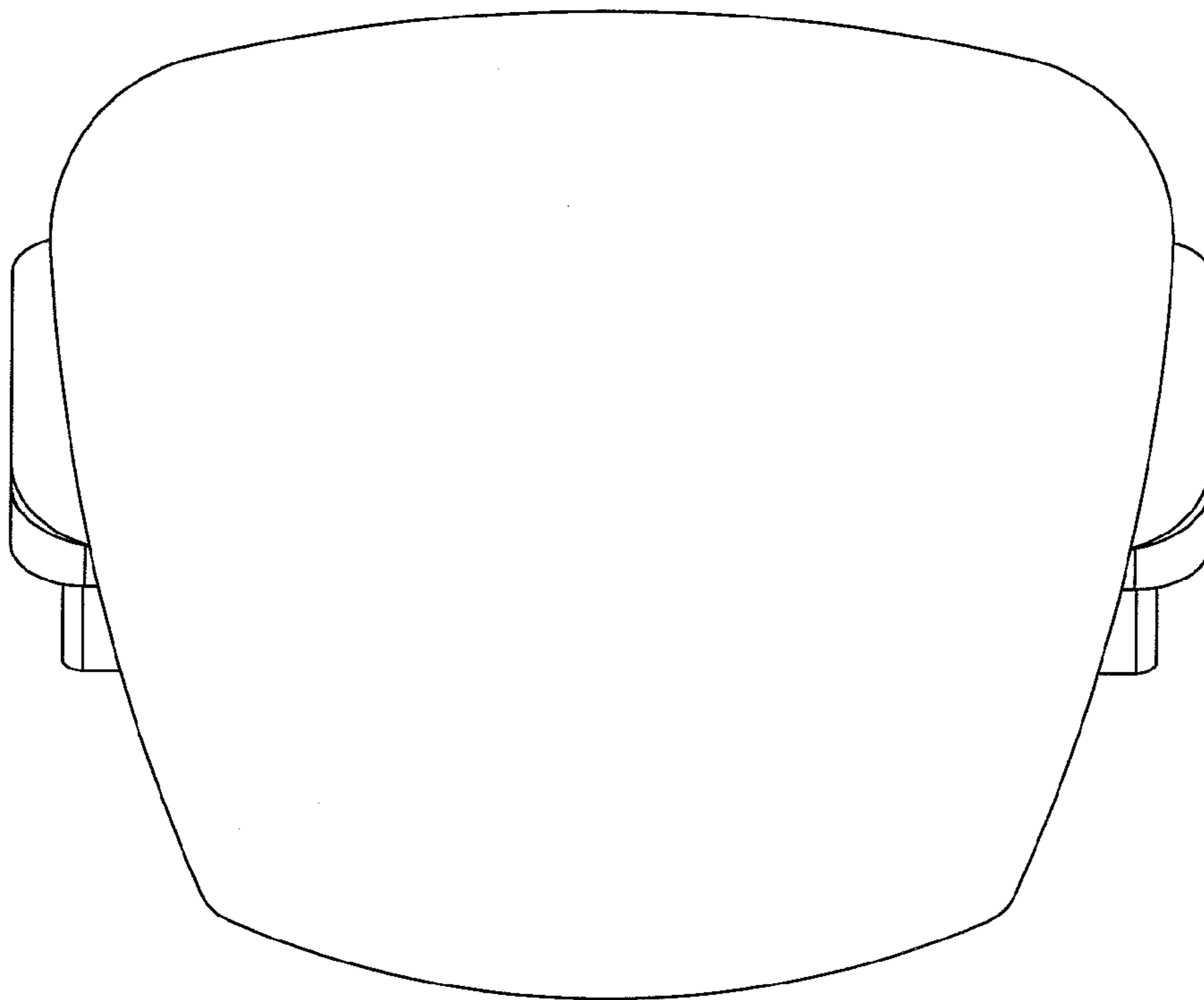

FIGURE 7

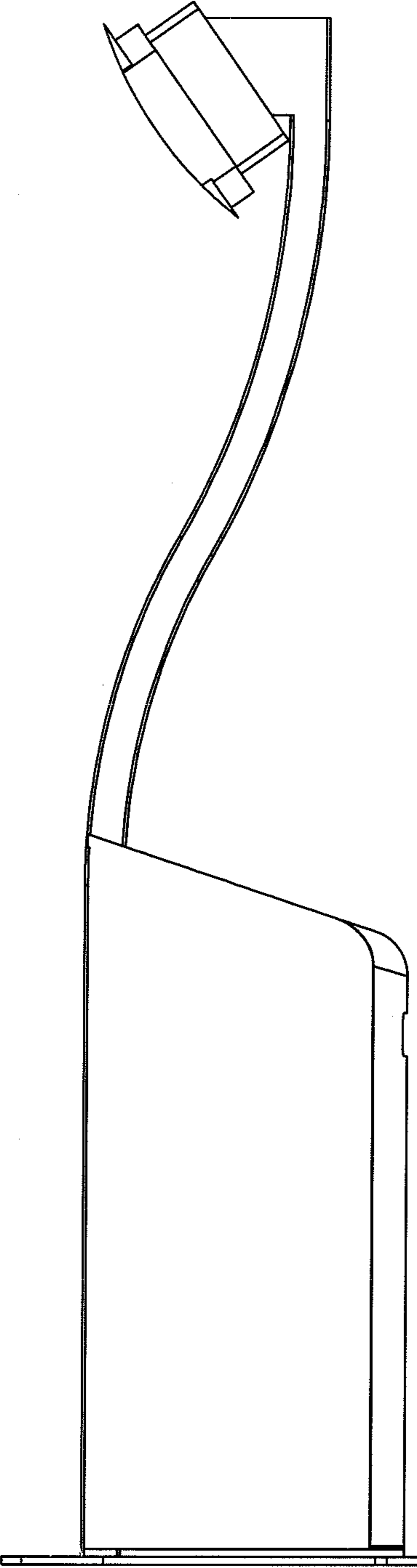

FIGURE 4

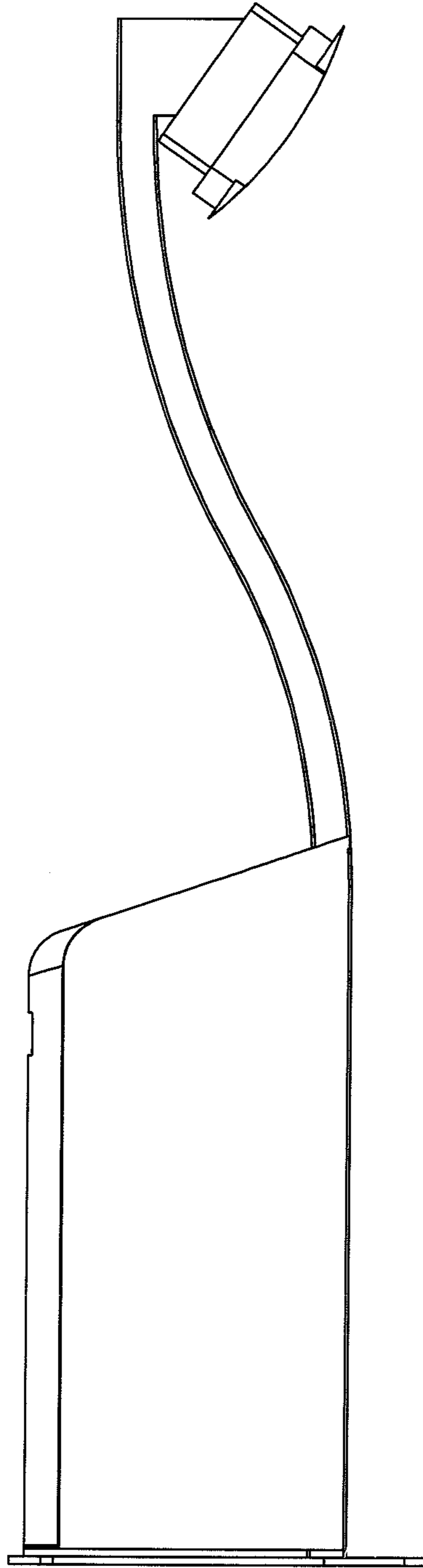

FIGURE 5

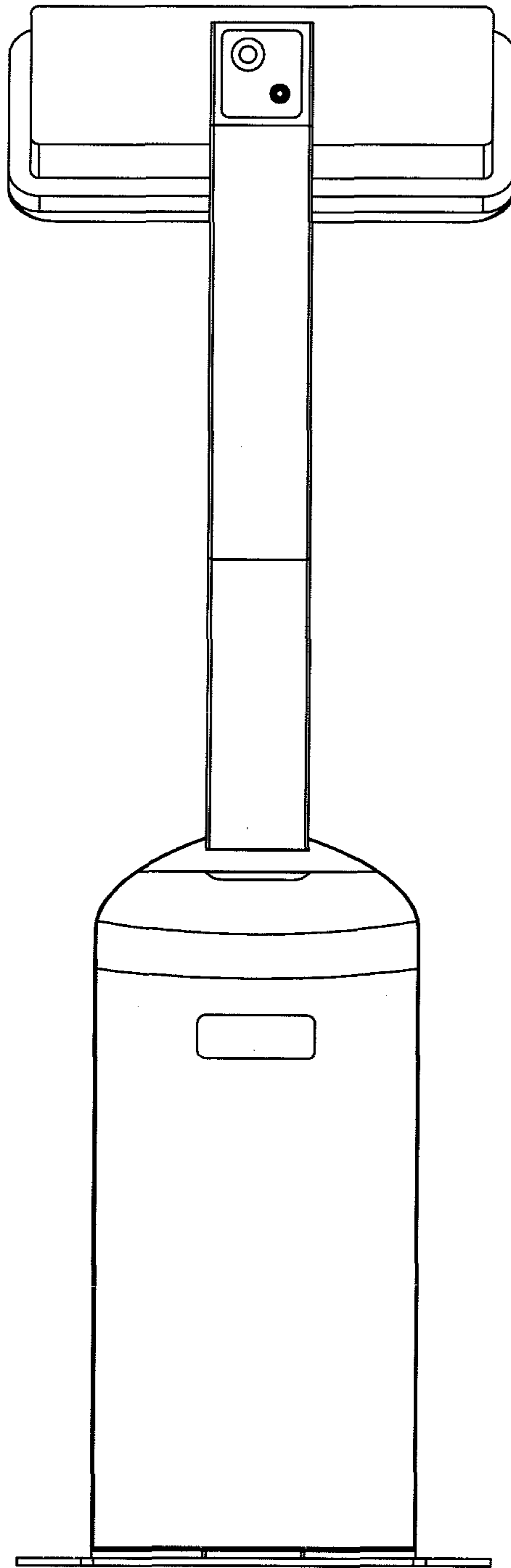

FIGURE 6