



US00D686682S

(12) **United States Design Patent**
Wilbur

(10) **Patent No.:** **US D686,682 S**
(45) **Date of Patent:** **** Jul. 23, 2013**

(54) **DUAL DIRECTIONAL HYBRID SURFBOARD**

Primary Examiner — Zenia Bennett

(71) Applicant: **Joshua Paul Wilbur**, Santa Cruz, CA
(US)

(72) Inventor: **Joshua Paul Wilbur**, Santa Cruz, CA
(US)

(**) Term: **14 Years**

(21) Appl. No.: **29/436,307**

(22) Filed: **Nov. 3, 2012**

(51) **LOC (9) Cl.** **21-02**

(52) **U.S. Cl.**
USPC **D21/769**

(58) **Field of Classification Search**
USPC D21/769–770, 801, 803, 809; 114/253,
114/345–346; 441/35, 66, 74, 40–42, 129–132;
472/128–129; D12/5, 6, 316
See application file for complete search history.

(56) **References Cited**

U.S. PATENT DOCUMENTS

D349,935 S *	8/1994	Simonson	D21/769
D410,515 S *	6/1999	Alexander	D21/769
D527,781 S *	9/2006	Walden	D21/769
D528,179 S *	9/2006	Stagnaro	D21/769
D534,231 S *	12/2006	Dosta Vidal	D21/769
D663,372 S *	7/2012	Wilbur	D21/769

* cited by examiner

(57) **CLAIM**

The ornamental design for a dual directional hybrid surfboard, as shown.

DESCRIPTION

FIG. 1 is an upper front perspective view of my dual directional hybrid surfboard showing my new design;
 FIG. 2 is a lower rear perspective view of my dual directional hybrid surfboard design;
 FIG. 3 is a front elevational view of my dual directional hybrid surfboard design;
 FIG. 4 is a side elevational view of my dual directional hybrid surfboard design, the opposite side is identical thereto;
 FIG. 5 is a rear elevational view of my dual directional hybrid surfboard design;
 FIG. 6 is a top plan view of my dual directional hybrid surfboard design;
 FIG. 7 is a bottom plan view of my dual directional hybrid surfboard design;
 FIG. 8 is a cross sectional view taken along line 8-8 in FIG. 4 of my dual directional hybrid surfboard design; and,
 FIG. 9 is a cross sectional view taken along line 9-9 in FIG. 4 of my dual directional hybrid surfboard design.

1 Claim, 4 Drawing Sheets

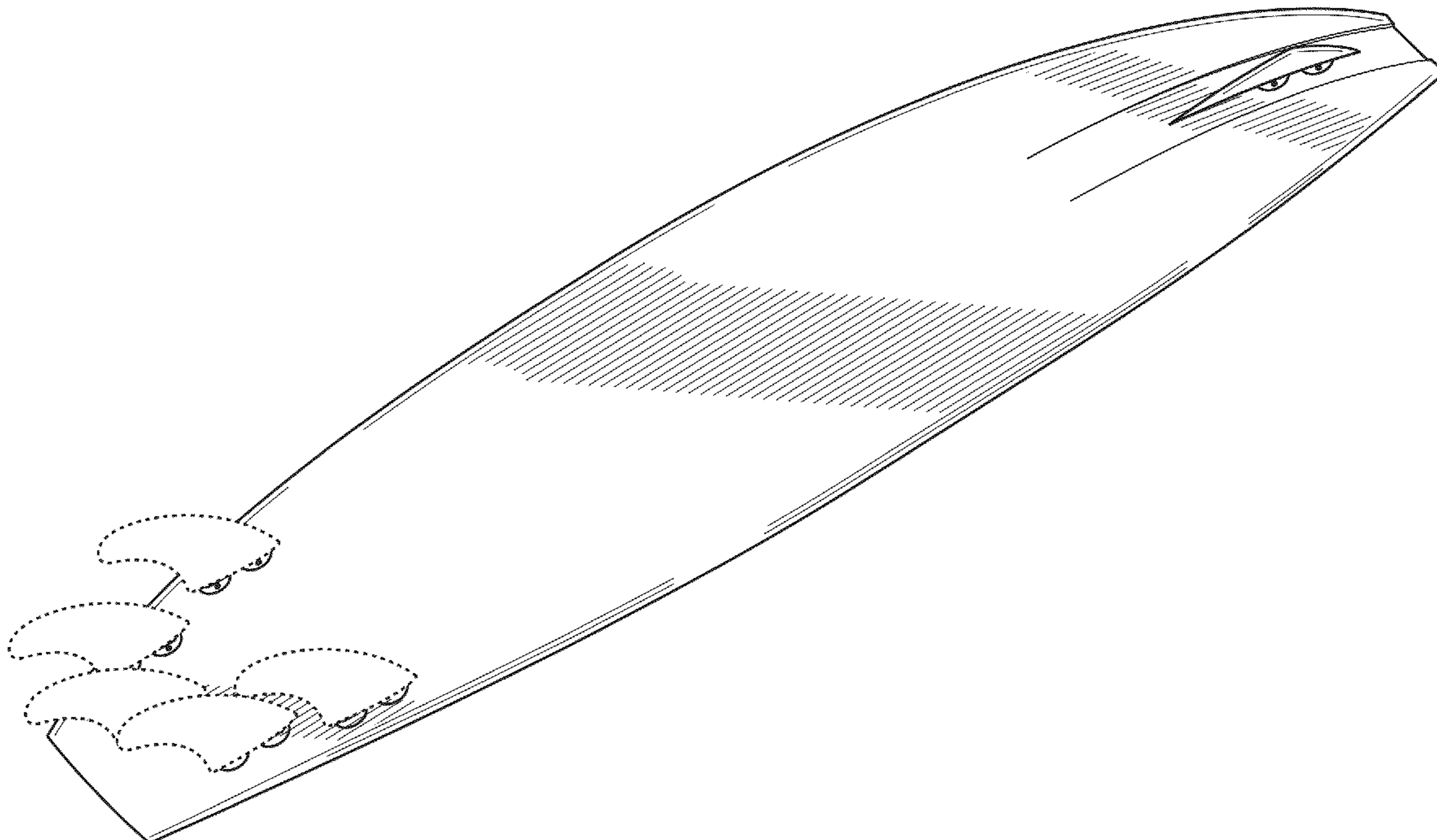

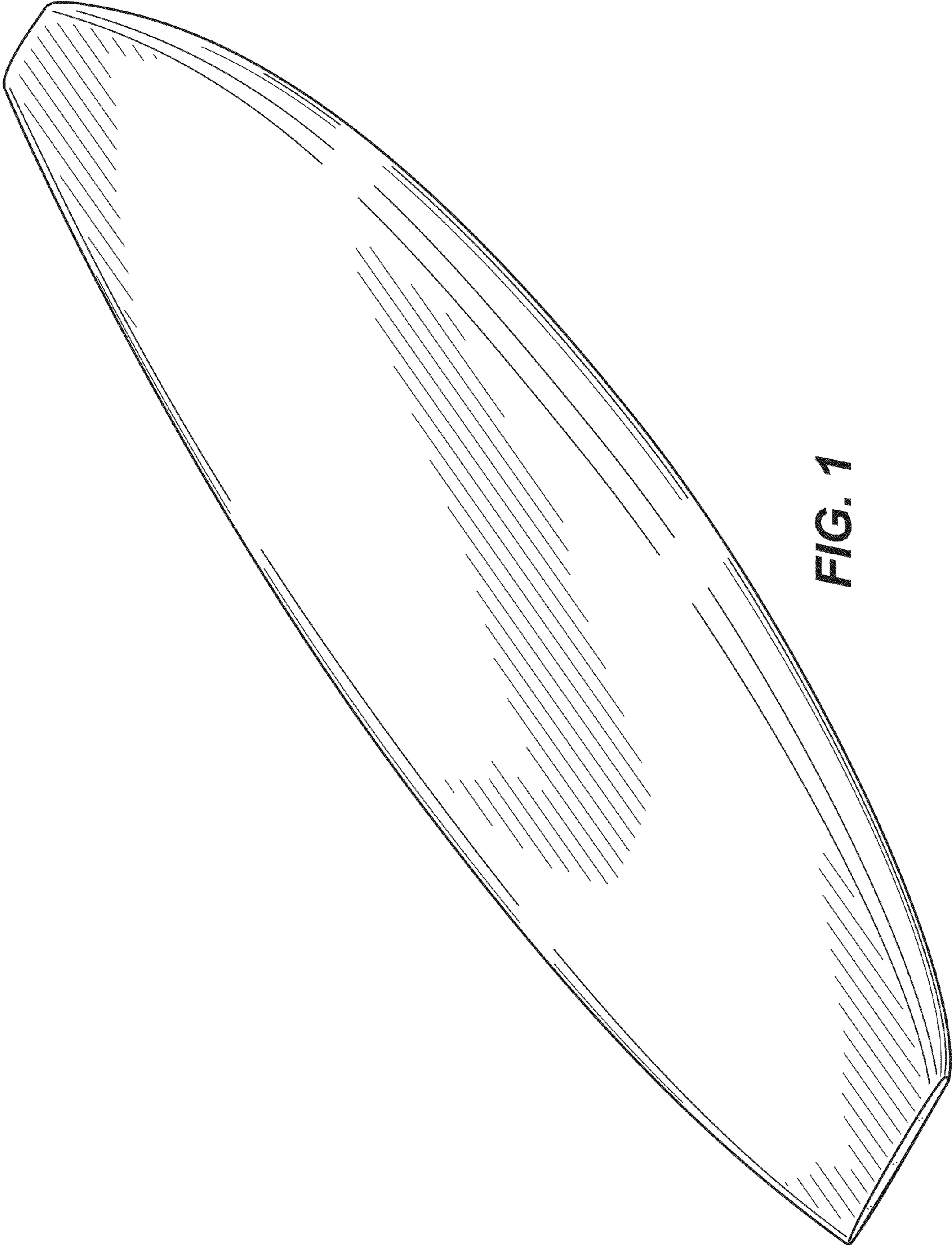

FIG. 1

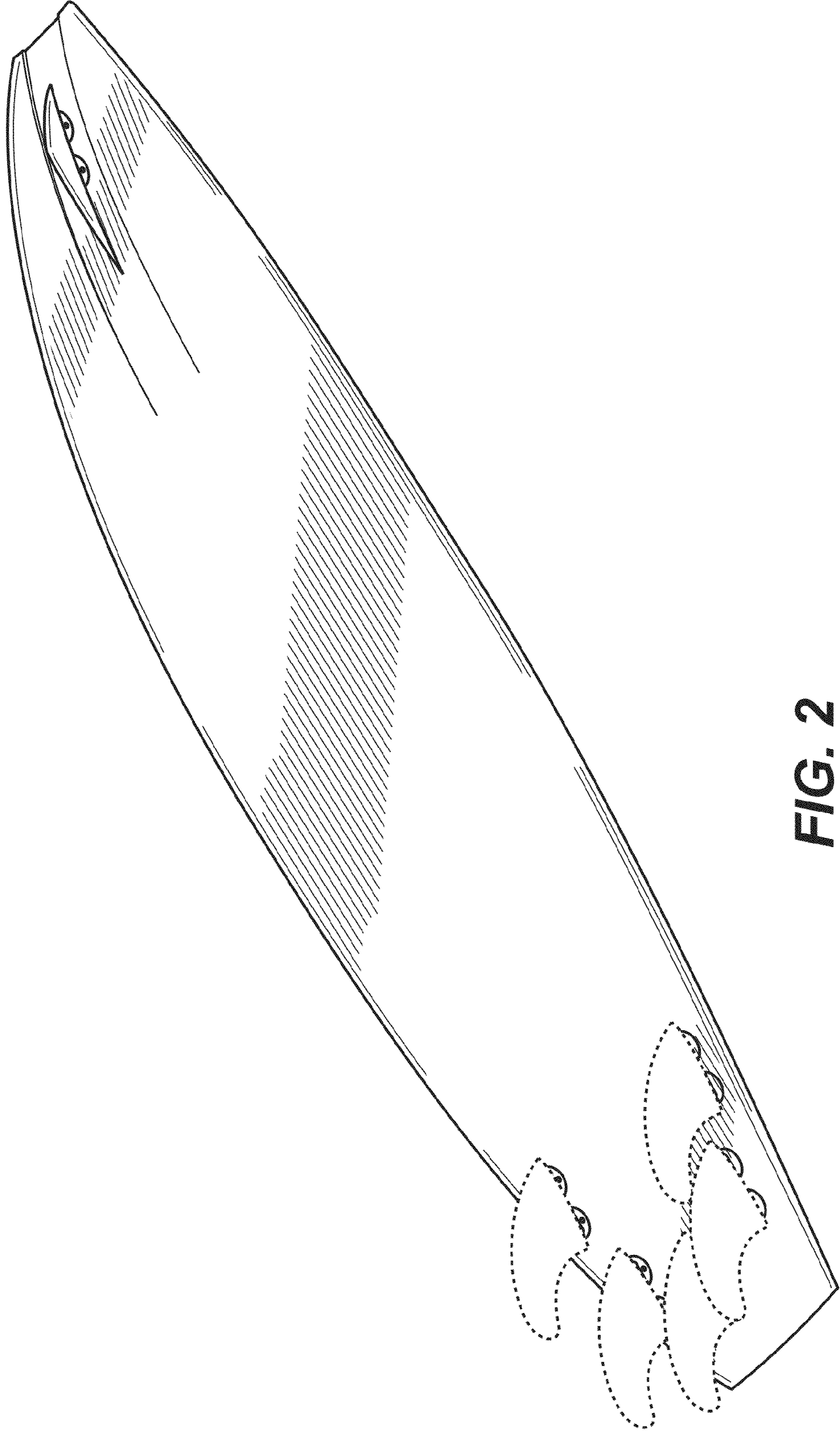

FIG. 2

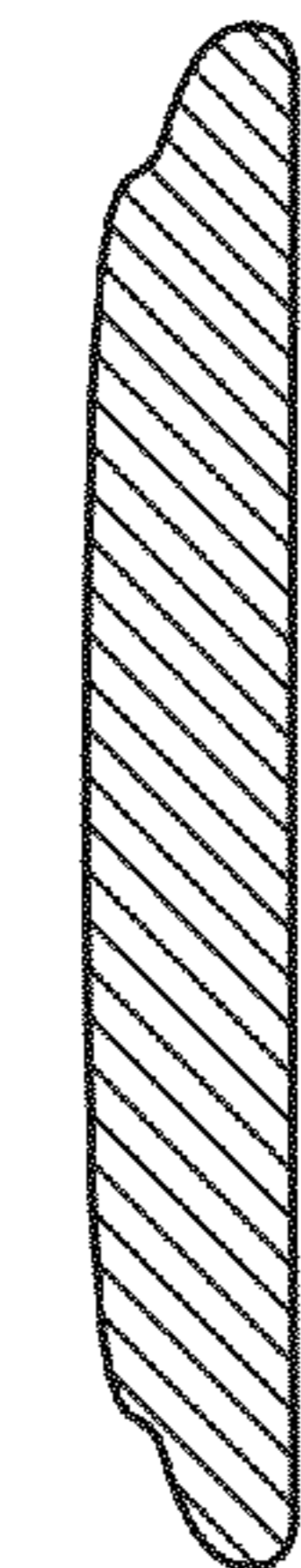

FIG. 8

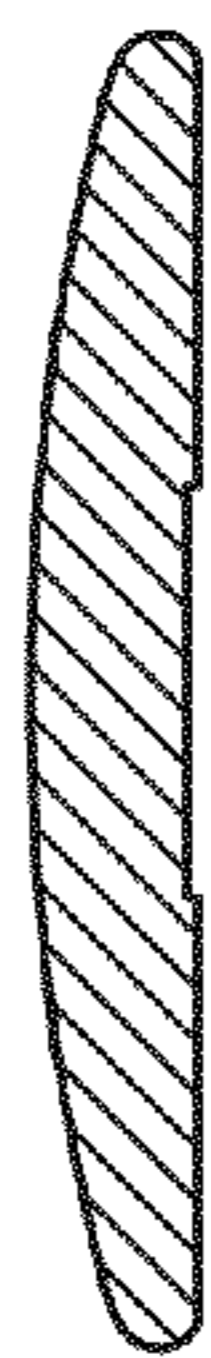

FIG. 9

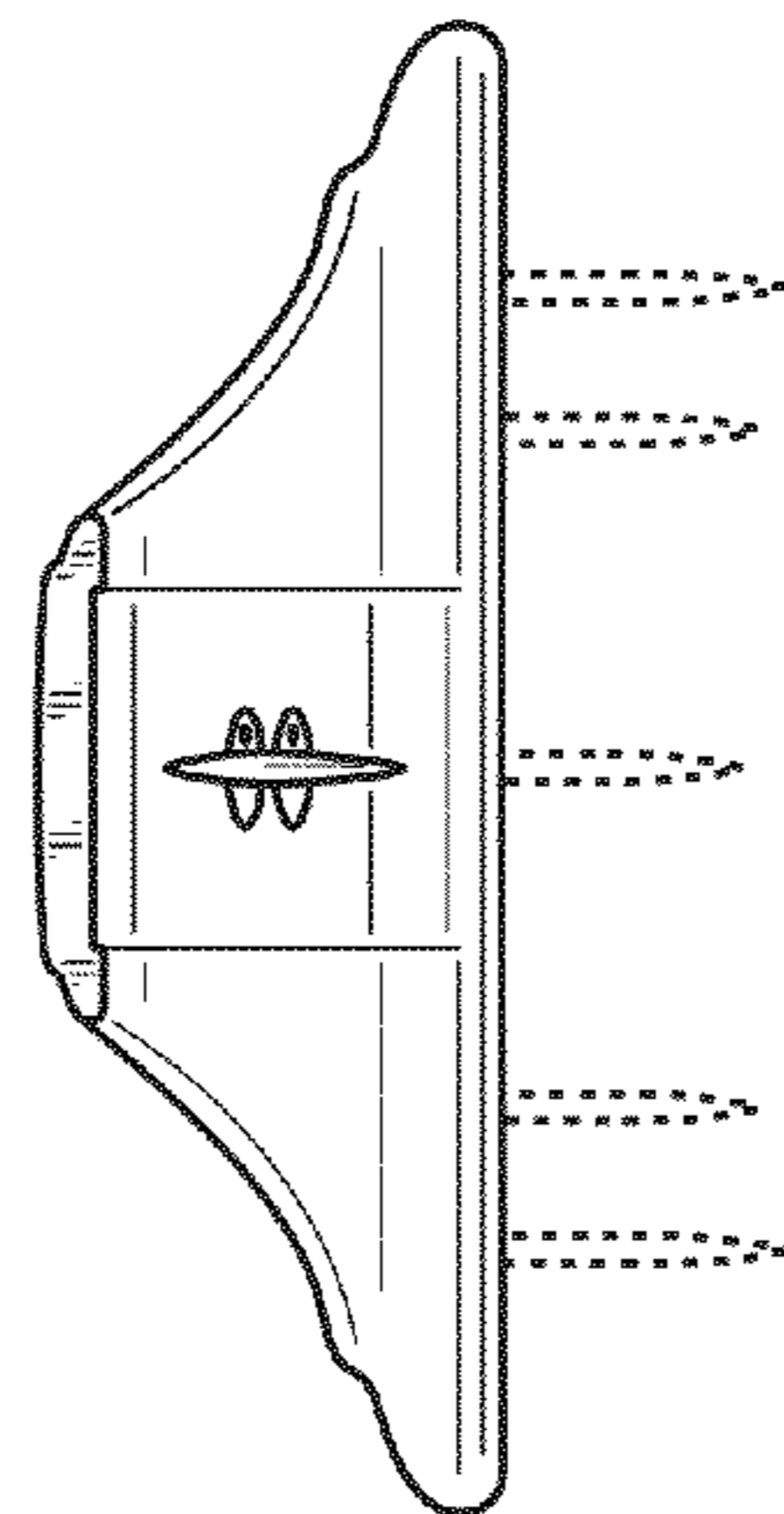

FIG. 3

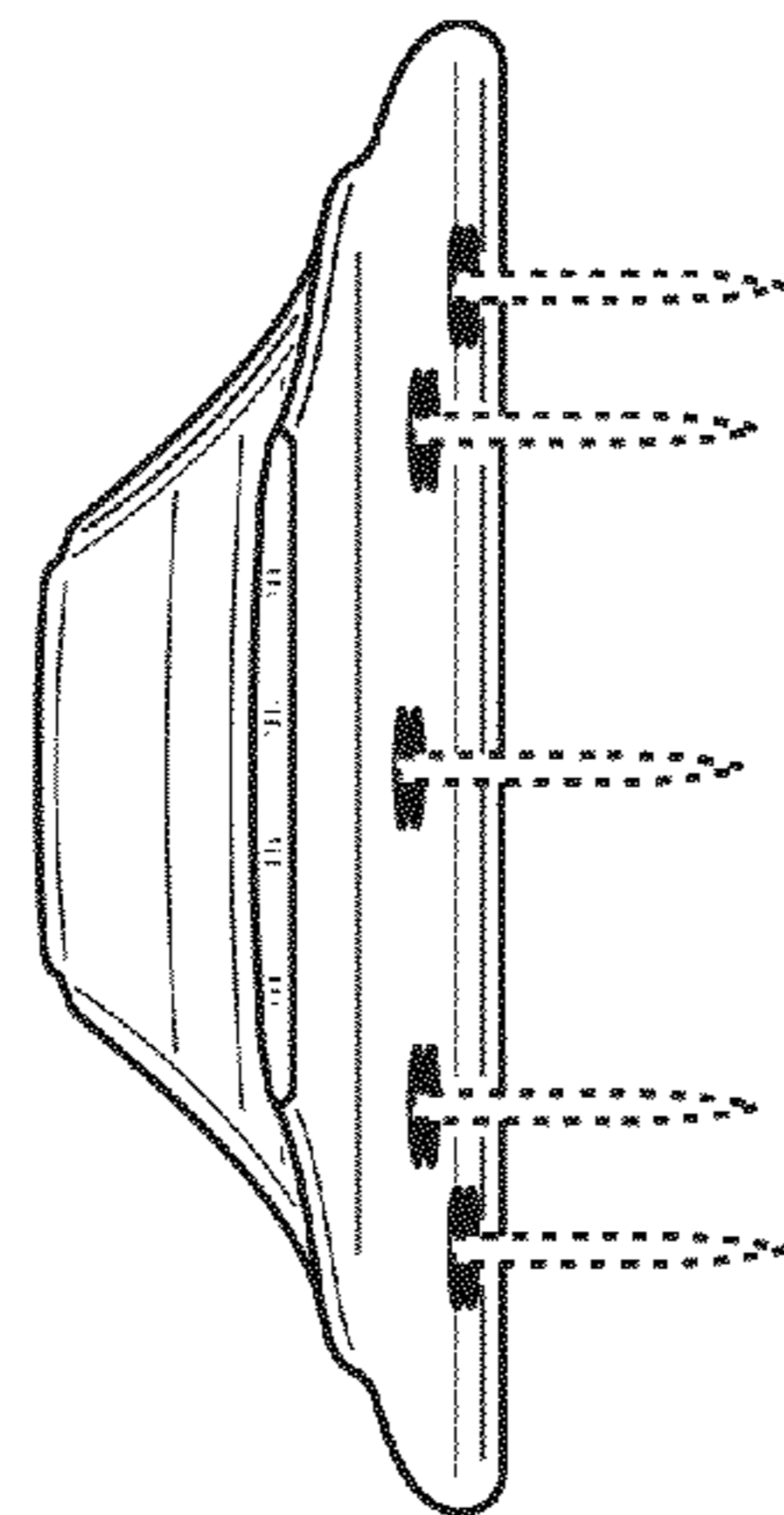

FIG. 5

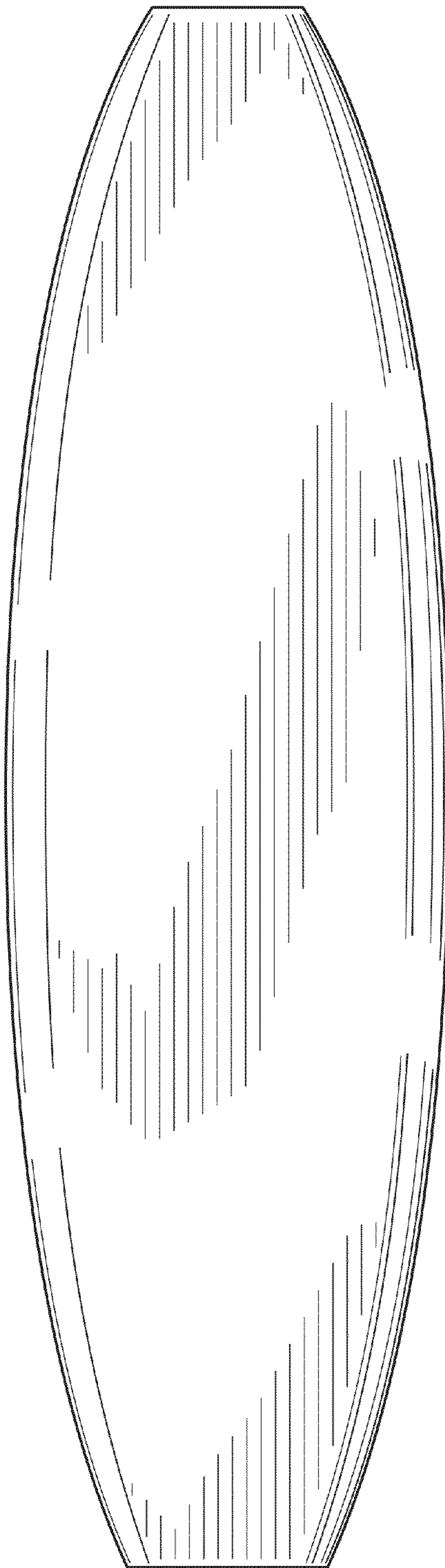

FIG. 6

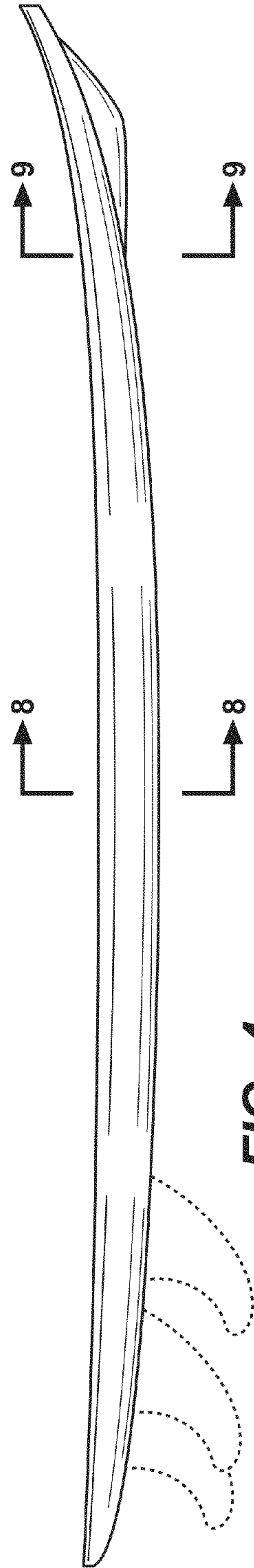

FIG. 4

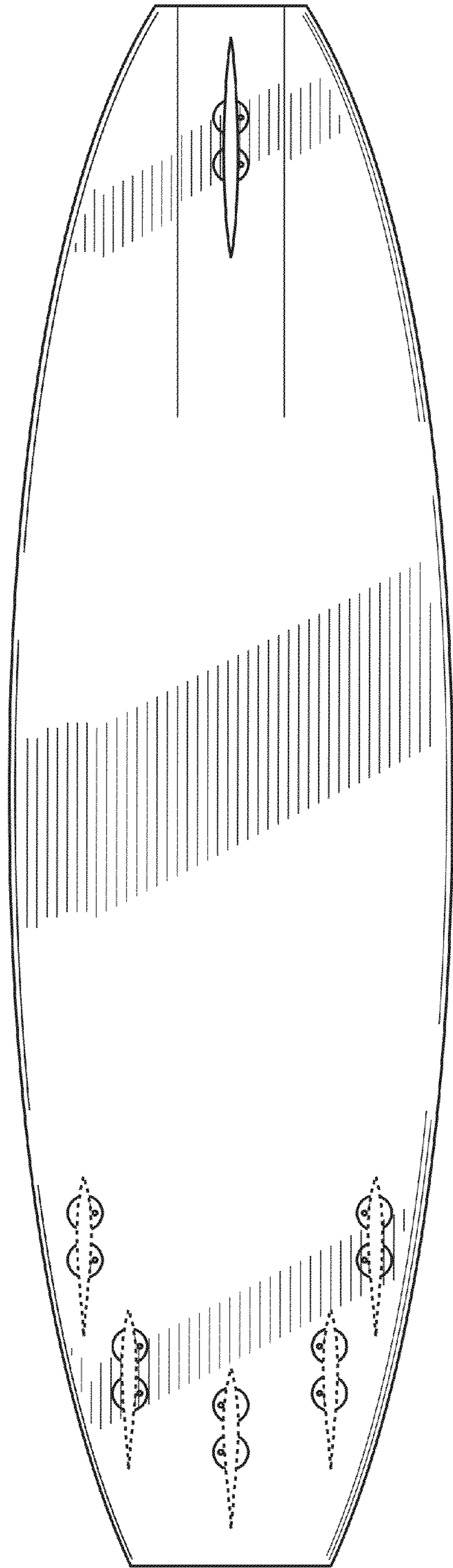

FIG. 7