



US00D686653S

(12) **United States Design Patent**  
**Tomasi et al.**

(10) **Patent No.:** **US D686,653 S**  
(45) **Date of Patent:** **\*\* Jul. 23, 2013**

(54) **FLUTE**

(76) Inventors: **Werner Tomasi**, Vienna (AT); **Barbara Gisler**, Vienna (AT)

(\*\*) Term: **14 Years**

(21) Appl. No.: **29/363,414**

(22) Filed: **Jun. 9, 2010**

(30) **Foreign Application Priority Data**

Dec. 10, 2009 (EM) ..... 001645581-0001

(51) **LOC (9) Cl.** ..... **17-02**

(52) **U.S. Cl.**  
USPC ..... **D17/10**

(58) **Field of Classification Search**  
USPC ..... D17/10, 11, 13; 84/395-396, 398,  
84/399, 453, 387 R, 384, 380 R, 621, 615,  
84/653

See application file for complete search history.

(56) **References Cited**

U.S. PATENT DOCUMENTS

3,888,154	A *	6/1975	Wesley, Sr.	84/384
4,353,281	A *	10/1982	DeFord	84/384
4,763,556	A *	8/1988	Peplowski	84/384
4,819,538	A *	4/1989	Nelson	84/384
5,014,585	A *	5/1991	Wesley, Sr.	84/384
5,780,757	A *	7/1998	Valtchev et al.	84/380 R
7,985,916	B2 *	7/2011	Shibata	84/621
2002/0139237	A1 *	10/2002	Momchilovich	84/400

2006/0283312	A1 *	12/2006	Shibata	84/724
2007/0017352	A1 *	1/2007	Masuda	84/658
2008/0072746	A1 *	3/2008	Shibata	84/671
2008/0083315	A1 *	4/2008	Wasser et al.	84/380 R
2012/0048094	A1 *	3/2012	Gisler et al.	84/384

FOREIGN PATENT DOCUMENTS

BE	1012659	A7	2/2001
DE	49789	C	3/1889
DE	9317027	U1	4/1994
DE	29907789	U1	7/1999
FR	624703	A	7/1927
JP	56123395	U	9/1981
KR	20080104949	A	3/2008

\* cited by examiner

*Primary Examiner* — Ian Simmons

*Assistant Examiner* — Carissa C Fitts

(74) *Attorney, Agent, or Firm* — Abelman, Frayne & Schwab

(57) **CLAIM**

The ornamental design for a flute, as shown and described.

**DESCRIPTION**

FIG. 1 is a front elevational view of the flute showing the new design;

FIG. 2 is a right side elevational view thereof;

FIG. 3 is a rear elevational view thereof;

FIG. 4 is a left side elevational view thereof;

FIG. 5 is a top plan view thereof;

FIG. 6 is a bottom plan view thereof; and,

FIG. 7 is a front, left side perspective view thereof.

**1 Claim, 7 Drawing Sheets**

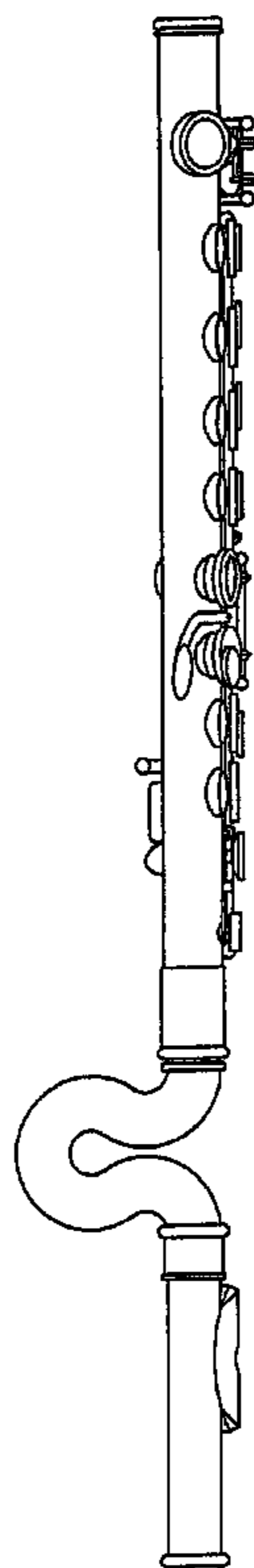
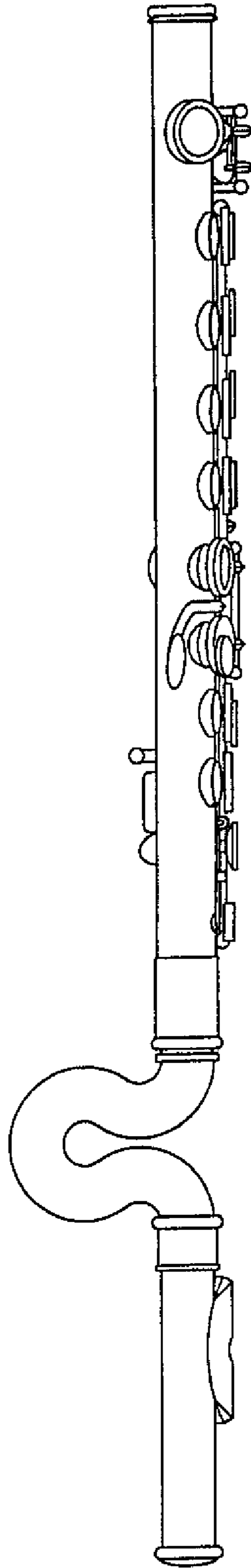

FIG. 1



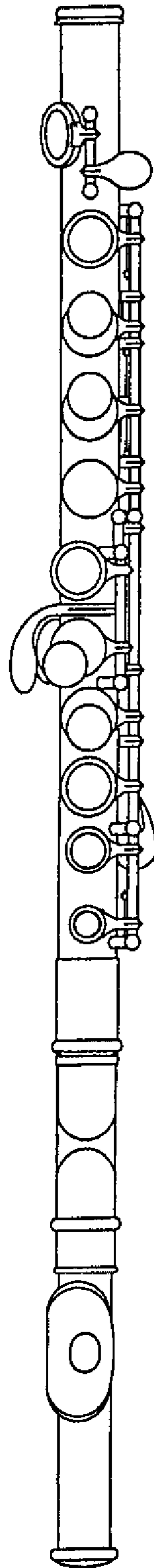

FIG. 2

FIG. 3

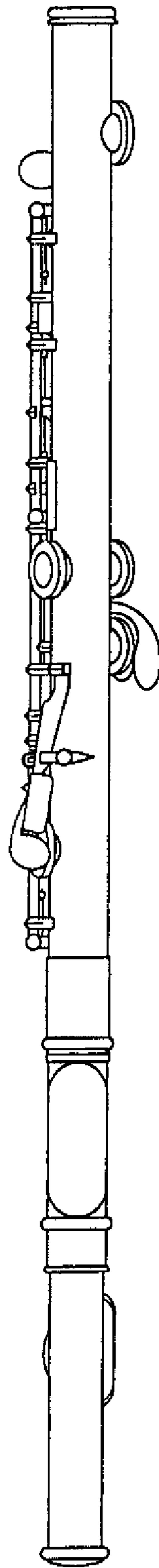
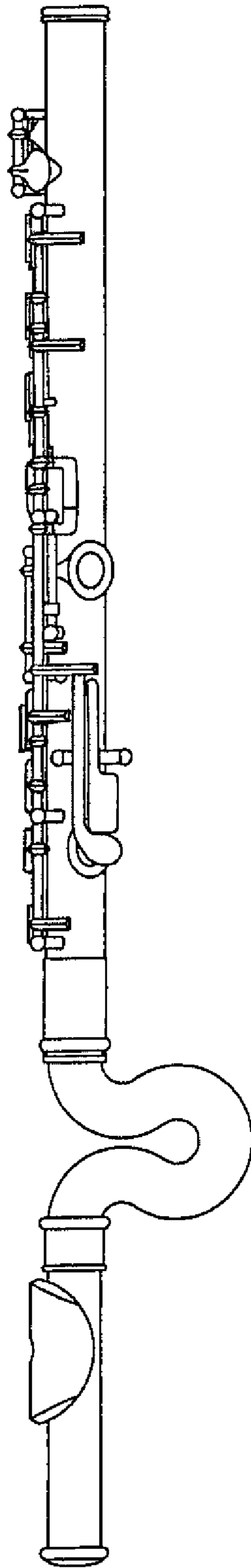
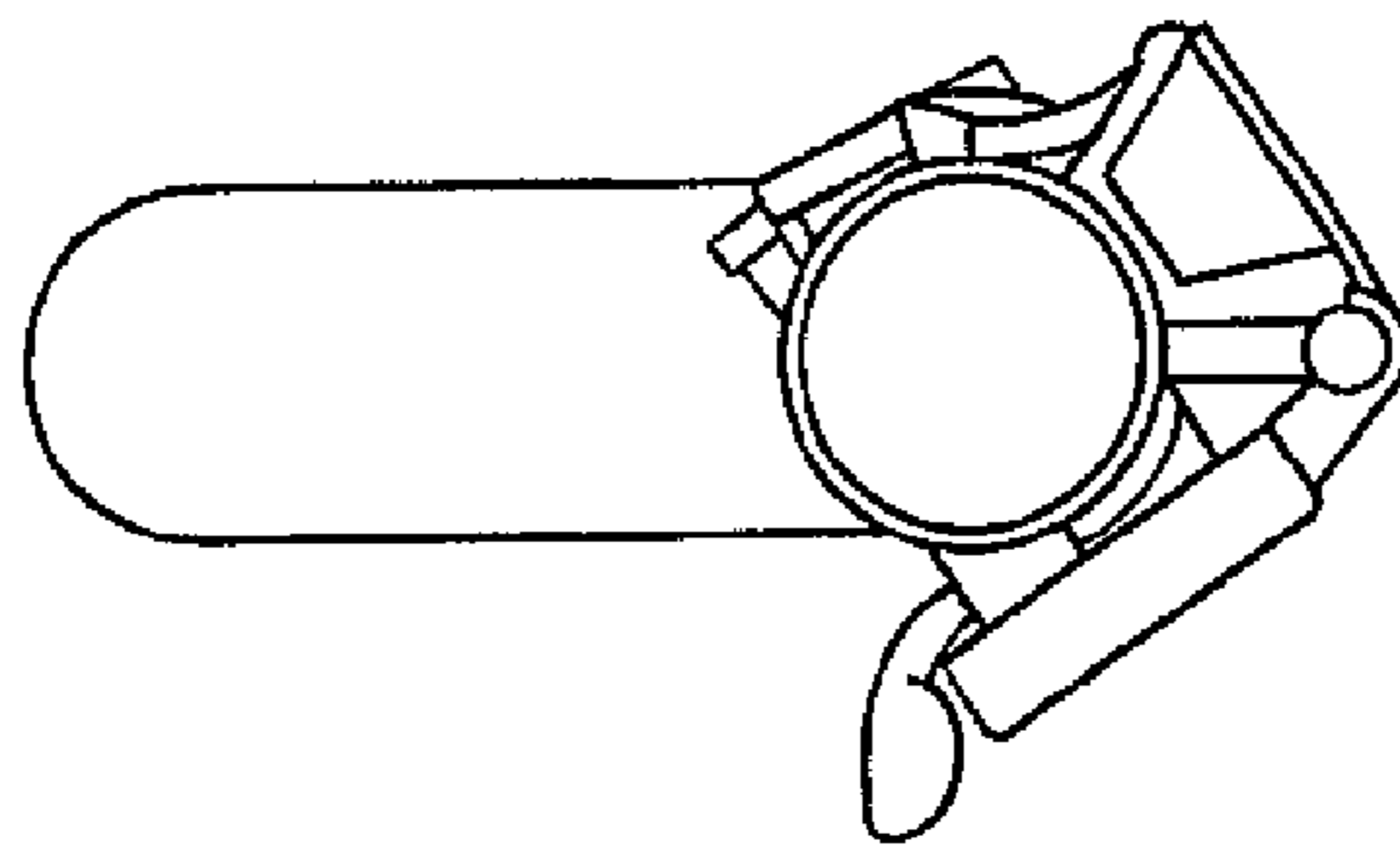
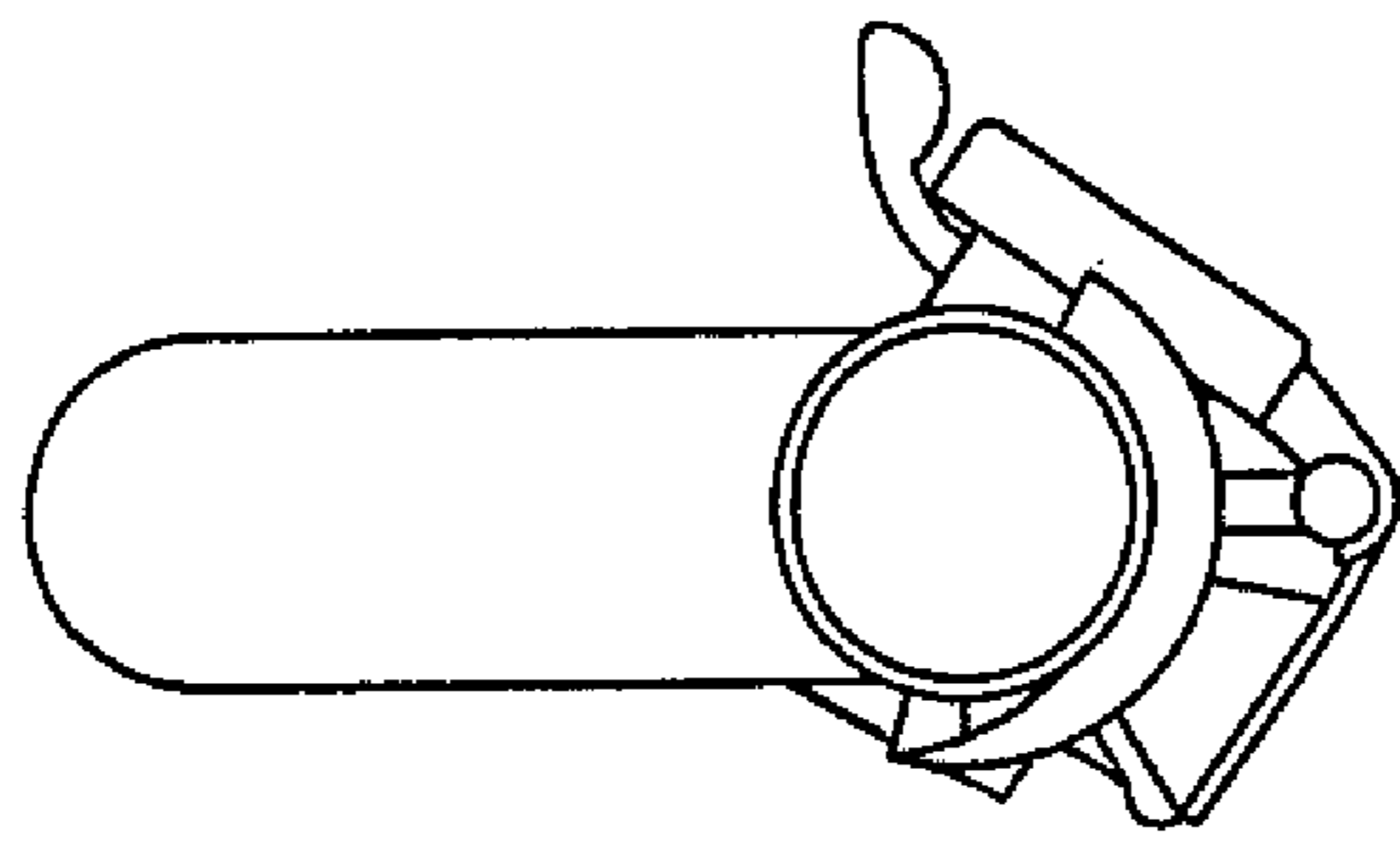

FIG. 4





*FIG. 5*



*FIG. 6*

FIG. 7

