



US00D686606S

(12) **United States Design Patent**  
**Hong**

(10) **Patent No.:** **US D686,606 S**

(45) **Date of Patent:** **\*\* Jul. 23, 2013**

(54) **PORTABLE ELECTRONIC DEVICE CASE**

(75) Inventor: **John Hong**, Chicago, IL (US)

(73) Assignee: **Uncommon LLC**, Chicago, IL (US)

(\*\*) Term: **14 Years**

(21) Appl. No.: **29/431,900**

(22) Filed: **Sep. 12, 2012**

(51) **LOC (9) Cl.** ..... **14-03**

(52) **U.S. Cl.**

USPC ..... **D14/250**

(58) **Field of Classification Search**

USPC ..... D14/250–253, 440, 203.3–203.7,  
D14/217, 496, 248, 238.1, 240, 447; D13/103,  
D13/107–108, 119; 220/4.02; 248/309.1,  
248/371, 176.3, 668; 361/679.56, 679.3,  
361/679.25, 816; 379/426, 433.11, 455;  
455/575.1, 575.8; 206/305, 320; 345/173;  
D3/201, 218, 247, 269, 273, 301, 303

See application file for complete search history.

(56) **References Cited**

**U.S. PATENT DOCUMENTS**

D575,056 S *	8/2008	Tan	.....	D3/218
D593,750 S *	6/2009	Song	.....	D3/269
D623,180 S *	9/2010	Diebel	.....	D14/250
D625,303 S *	10/2010	Kim	.....	D14/250
D649,539 S *	11/2011	Hong	.....	D14/250
D651,205 S *	12/2011	Soekoro	.....	D14/250
D653,655 S *	2/2012	Polito et al.	.....	D14/250
D659,132 S *	5/2012	Wen	.....	D14/250
D663,725 S *	7/2012	Polito et al.	.....	D14/250
8,297,440 B2 *	10/2012	Schmidt et al.	.....	206/320
D673,554 S *	1/2013	Simmer	.....	D14/250
D674,380 S *	1/2013	Soekoro	.....	D14/250

**OTHER PUBLICATIONS**

Review of Uncommon Customized Black Bezel Deflector Case for iPhone, posted Jan. 22, 2013, <URL:http://bayareamommy.net/2013/01/uncommon-customized-iphone-case-review/>, retrieved from internet on Mar. 9, 2013.\*

Review of Clearly Uncommon Deflector Case for iPhone, published on Jan. 19, 2013, <URL:http://www.youtube.com/watch?v=MACvP\_4DxwM>, retrieved from internet on Mar. 9, 2013.\*

\* cited by examiner

*Primary Examiner* — Carla Jobe Wright

(74) *Attorney, Agent, or Firm* — Bishop & Diehl, Ltd.

(57) **CLAIM**

The ornamental design for a portable electronic device case, as shown and described.

**DESCRIPTION**

FIG. 1 is a perspective back view of a portable electronic device case;

FIG. 2 is a perspective front view of the portable electronic device case of FIG. 1;

FIG. 3 is a back elevation view of the portable electronic device case of FIG. 1;

FIG. 4 is a front elevation view of the portable electronic device case of FIG. 1;

FIG. 5 is a right side elevation view of the portable electronic device case of FIG. 1;

FIG. 6 is a left side elevation view of the portable electronic device case of FIG. 1;

FIG. 7 is a top plan view of the portable electronic device case of FIG. 1; and,

FIG. 8 is a bottom plan view of the portable electronic device case of FIG. 1.

**1 Claim, 6 Drawing Sheets**

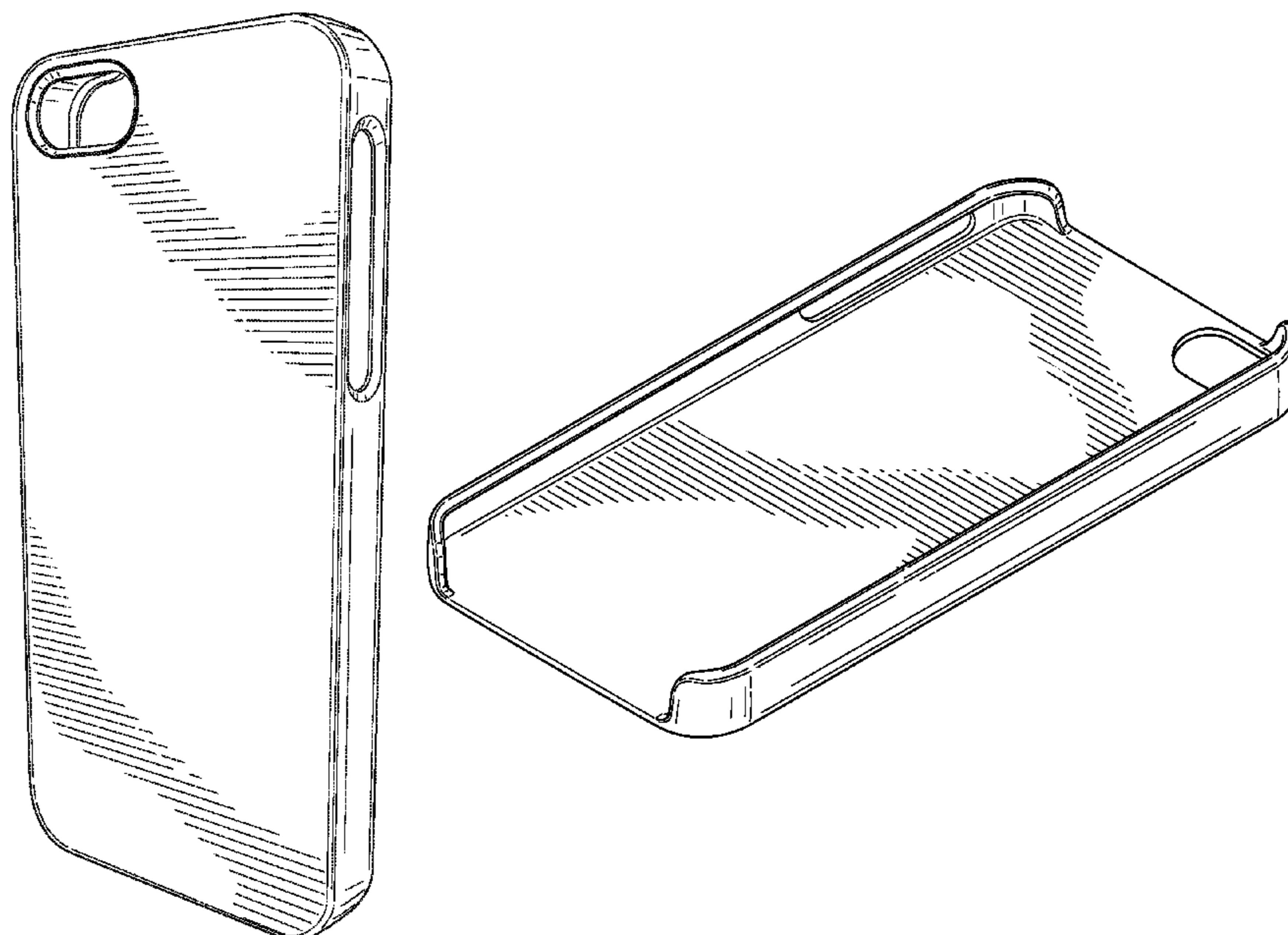

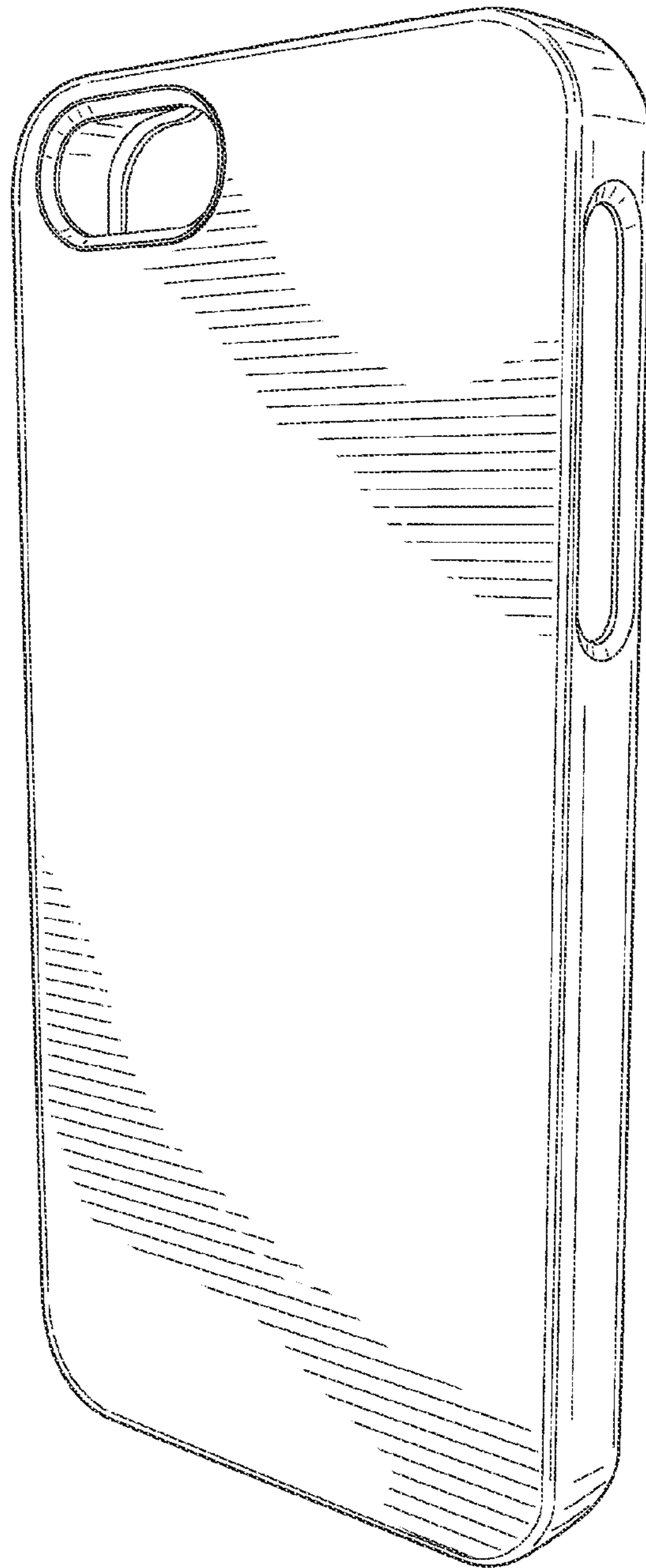
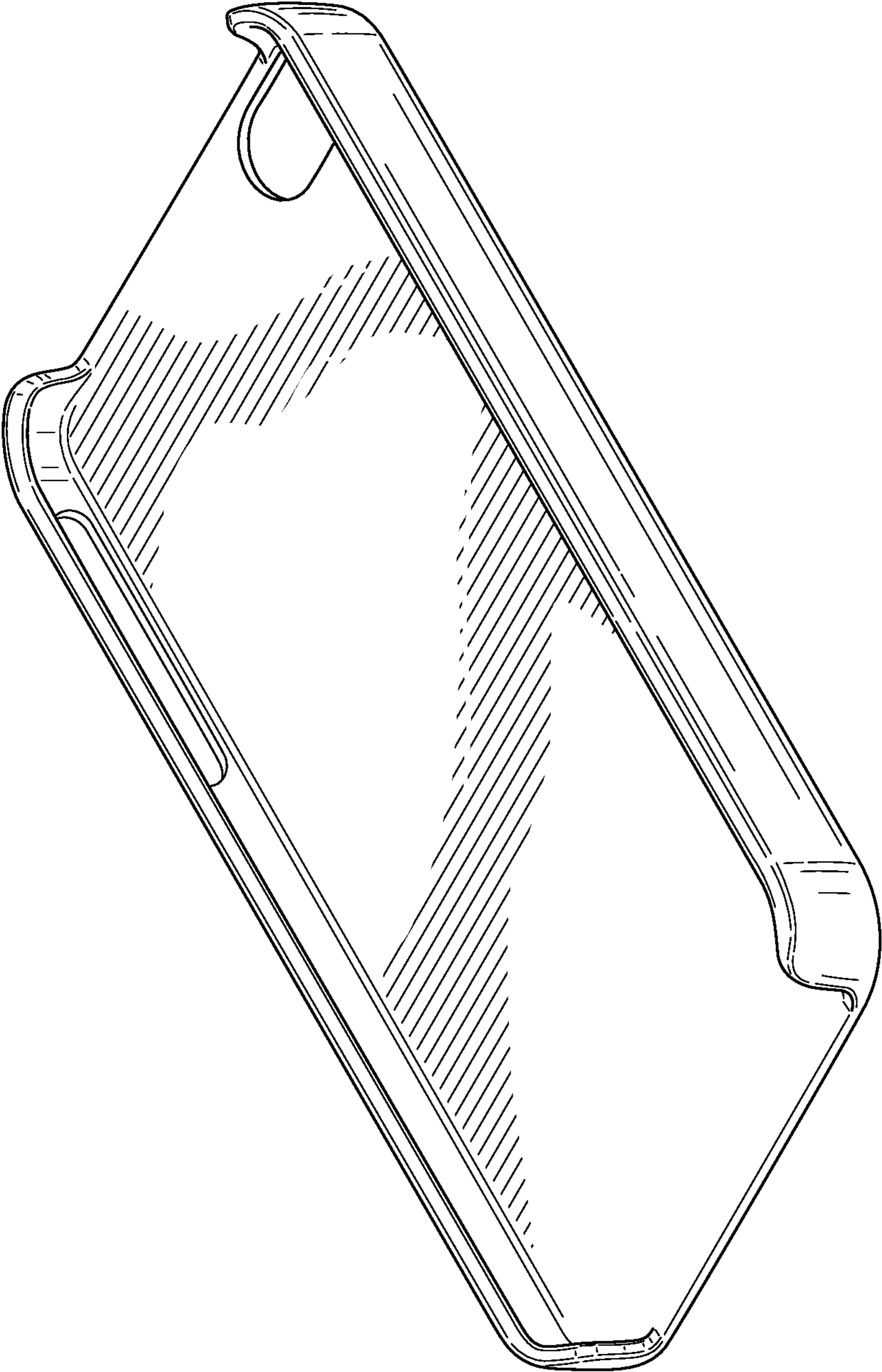
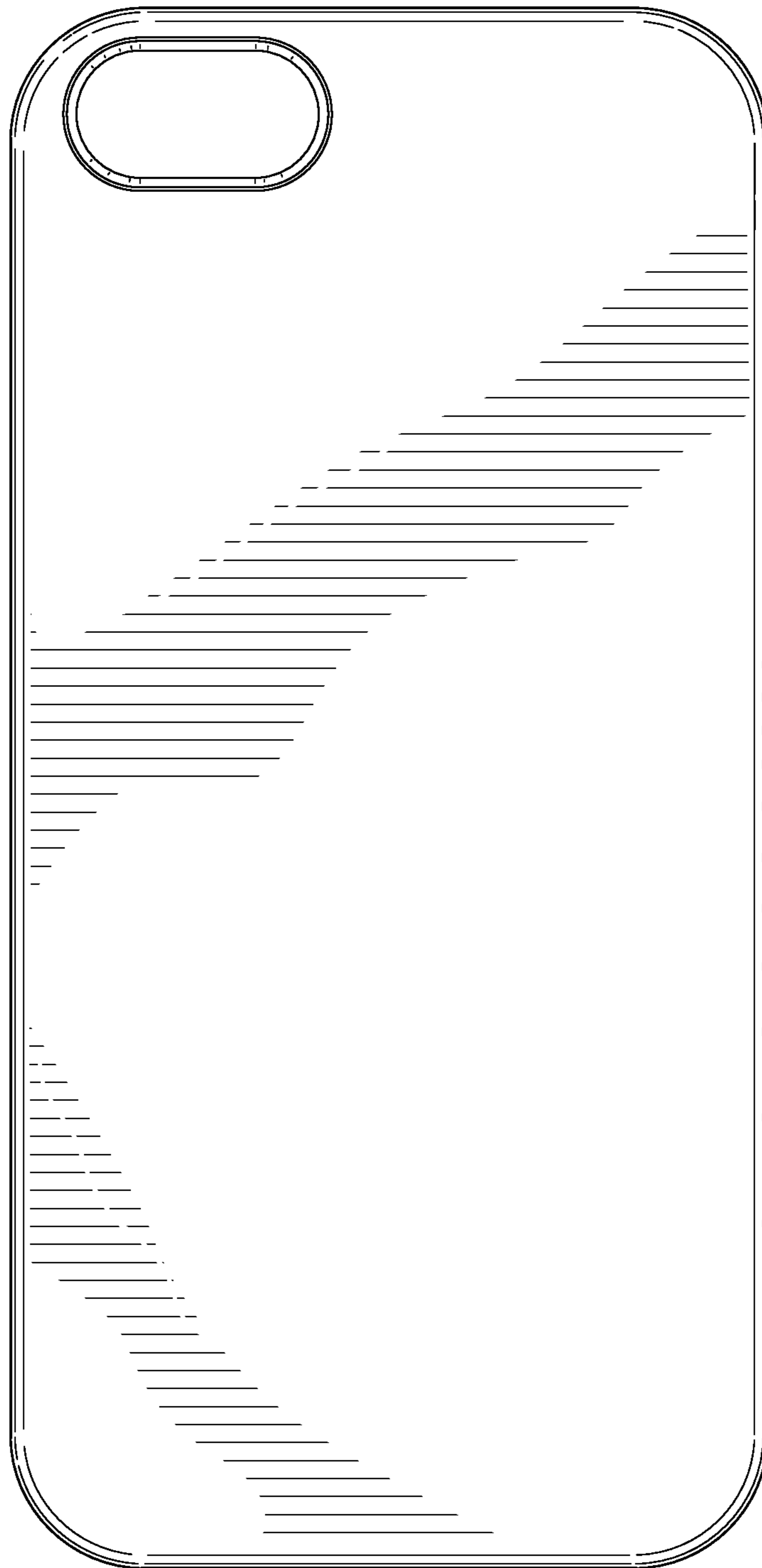

FIG. 1



**FIG. 2**



**FIG. 3**

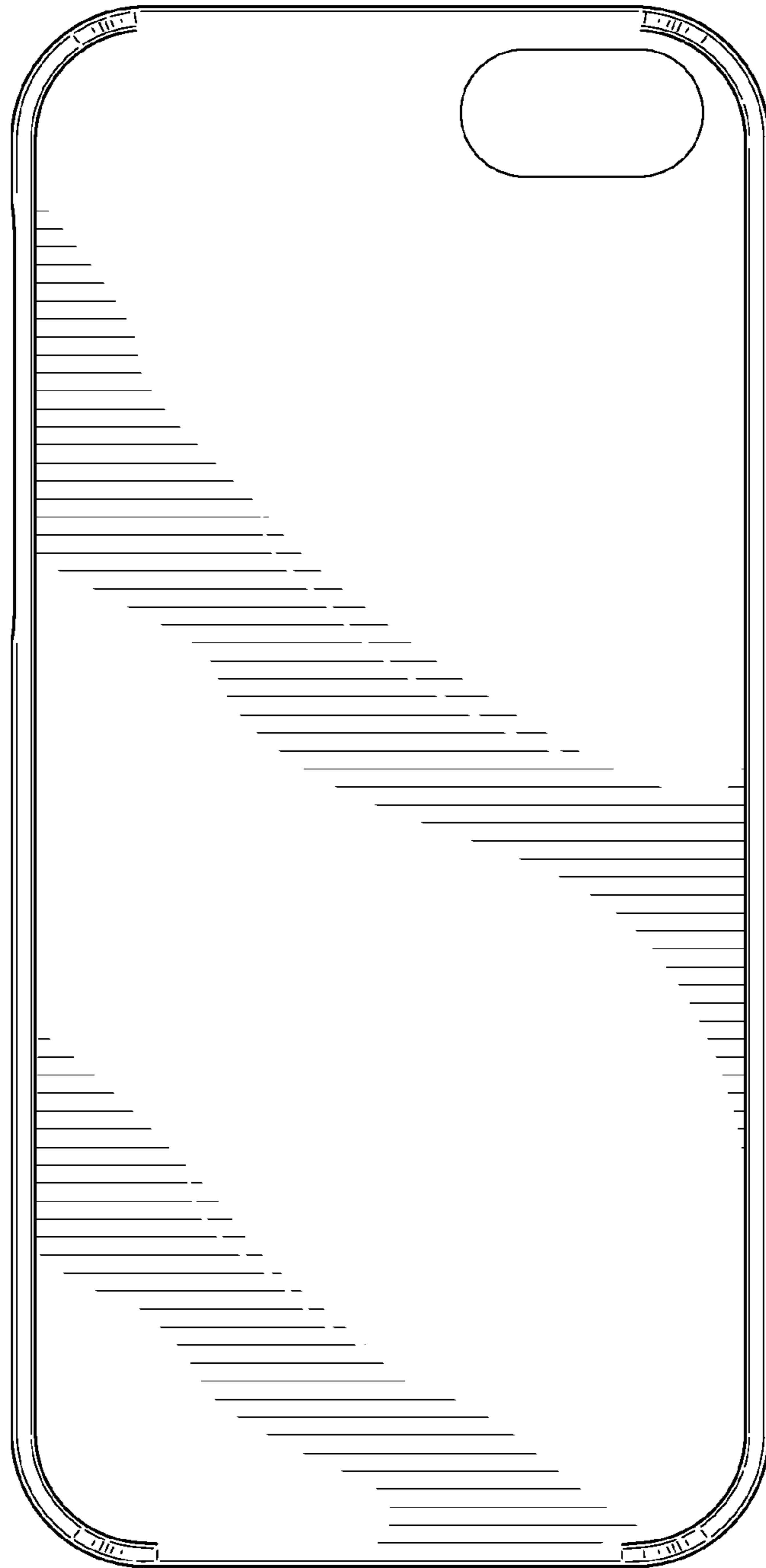

**FIG. 4**

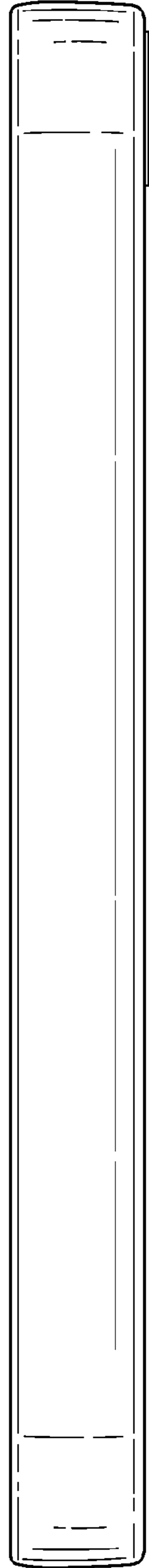

**FIG. 5**

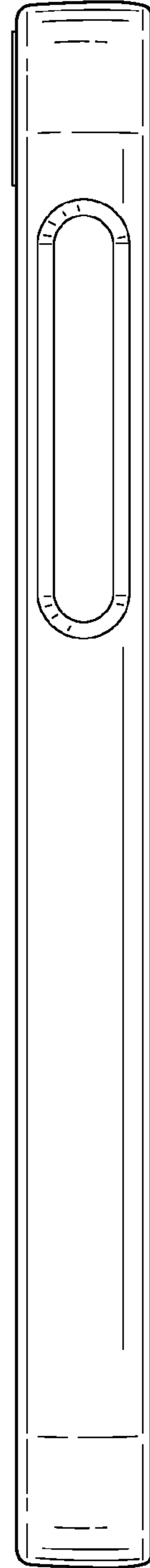
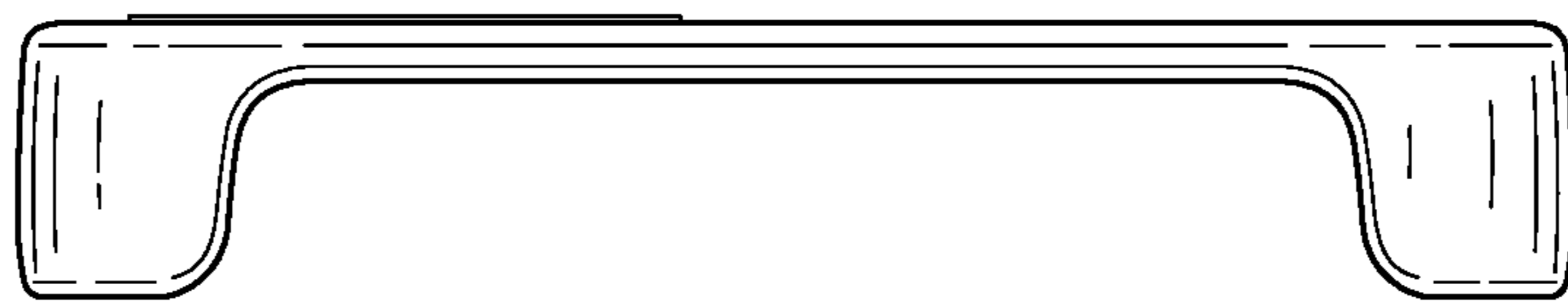

**FIG. 6**





**FIG. 7**



**FIG. 8**