



US00D686422S

(12) **United States Design Patent**
Robinson

(10) **Patent No.:** **US D686,422 S**
(45) **Date of Patent:** **** Jul. 23, 2013**

- (54) **SEAT**
- (76) Inventor: **Dominic James Robinson**, Addlestone (GB)
- (**) Term: **14 Years**
- (21) Appl. No.: **29/415,504**
- (22) Filed: **Mar. 12, 2012**
- (51) **LOC (9) Cl.** **06-01**
- (52) **U.S. Cl.**
USPC **D6/356**
- (58) **Field of Classification Search**
USPC D6/334-336, 356, 367, 371-373, D6/374, 375, 381, 716, 716.1, 716.2, 716.3, D6/716.4, 716.5; 297/163, 173, 216.1, 216.2, 297/232, 248, 344.1, 353, 354.1, 452.18, 297/452.19, 452.24, 452.35
See application file for complete search history.

- 6,793,282 B2 * 9/2004 Plant et al. 297/248
- D505,796 S * 6/2005 Johnson D6/356
- 7,066,551 B2 * 6/2006 Johnson 297/452.18
- D605,863 S * 12/2009 Aruga et al. D6/356
- 2003/0094838 A1 * 5/2003 Williamson 297/232
- 2003/0094842 A1 * 5/2003 Williamson 297/232
- 2004/0212228 A1 * 10/2004 Skelly et al. 297/232
- 2012/0292967 A1 * 11/2012 Cailleteau 297/354.1

* cited by examiner

Primary Examiner — Mimoso De

(74) *Attorney, Agent, or Firm* — Withrow & Terranova, PLLC

(57) **CLAIM**

The ornamental design for a seat, as shown and described.

DESCRIPTION

FIG. 1 is front perspective view of an exemplary seat;
 FIG. 2 is a front view of the seat of FIG. 1;
 FIG. 3 is a rear view of the seat of FIG. 1;
 FIG. 4 is a left side view of the seat of FIG. 1;
 FIG. 5 is a right side view of the seat of FIG. 1;
 FIG. 6 is a top view of the seat of FIG. 1;
 FIG. 7 is a bottom view of the seat of FIG. 1; and,
 FIG. 8 is a rear perspective view of the seat of FIG. 1.
 Broken lines in the drawings are for illustrative purposes only and do not form part of the claimed design.

1 Claim, 8 Drawing Sheets

(56) **References Cited**

U.S. PATENT DOCUMENTS

- D250,071 S * 10/1978 Dickerson D6/356
- D273,642 S * 5/1984 Marrujo D6/356
- D336,379 S * 6/1993 Veneruso D6/356
- 6,644,738 B2 * 11/2003 Williamson 297/232
- 6,669,143 B1 * 12/2003 Johnson 244/122 R



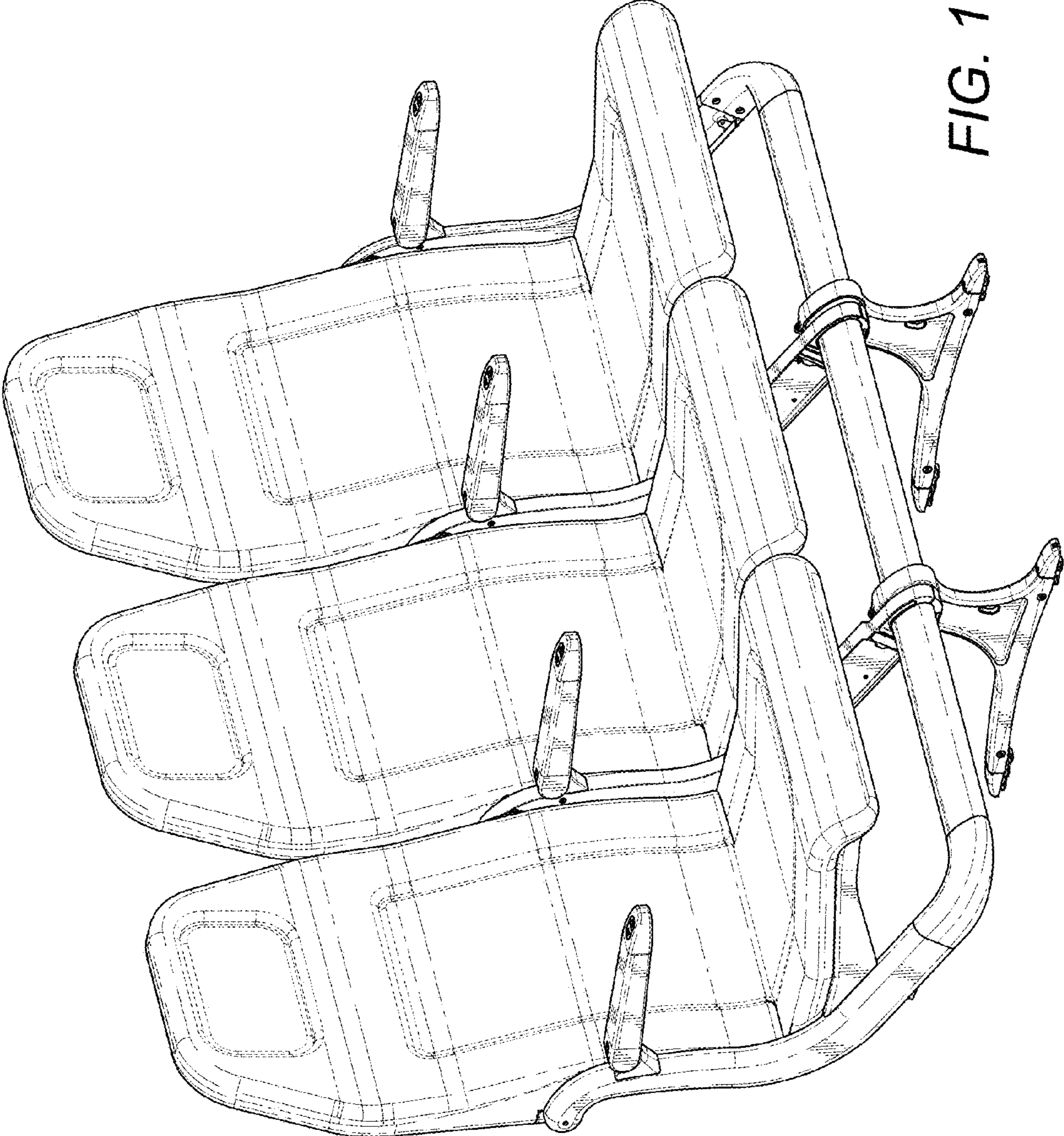

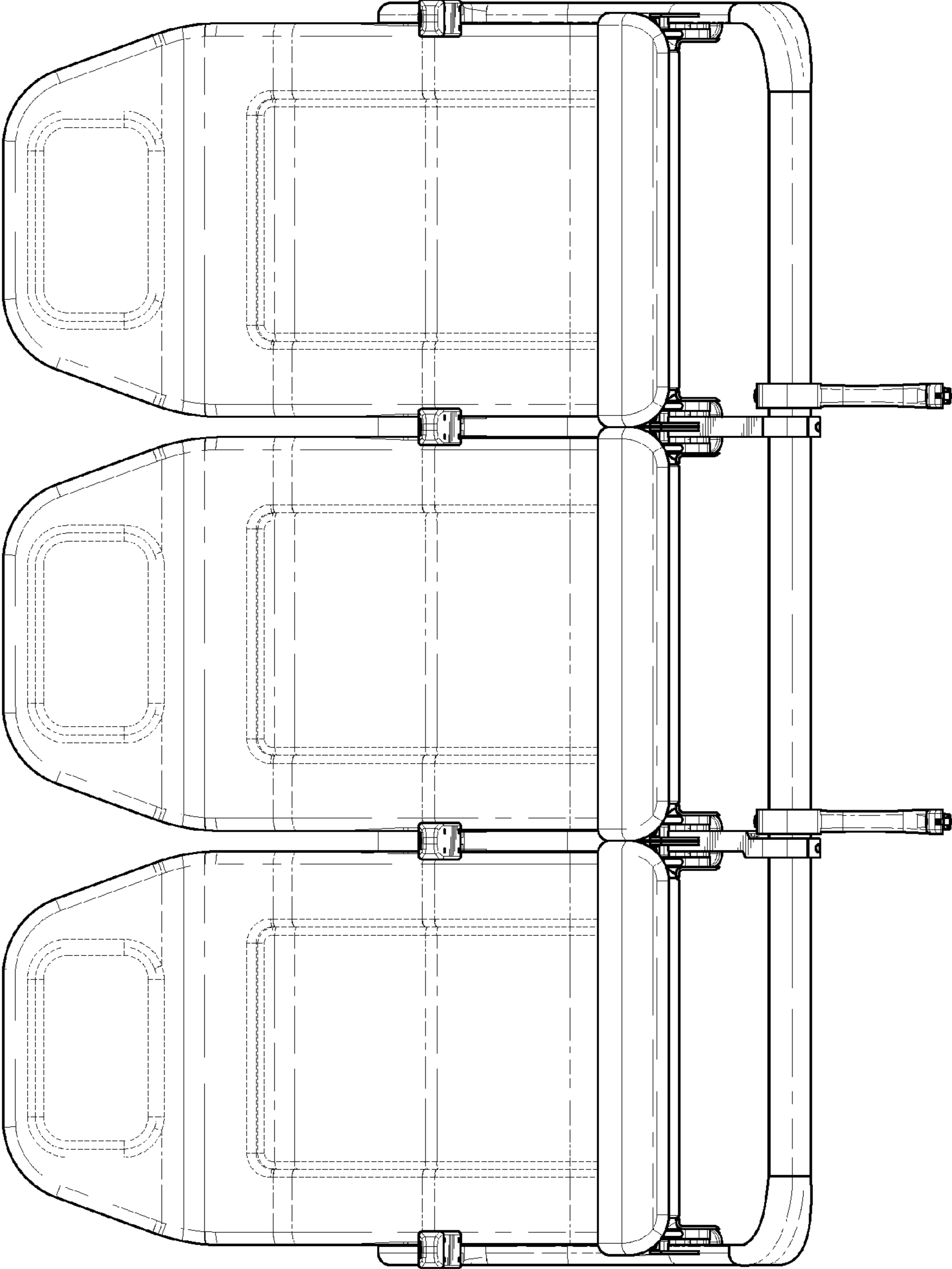

FIG. 2

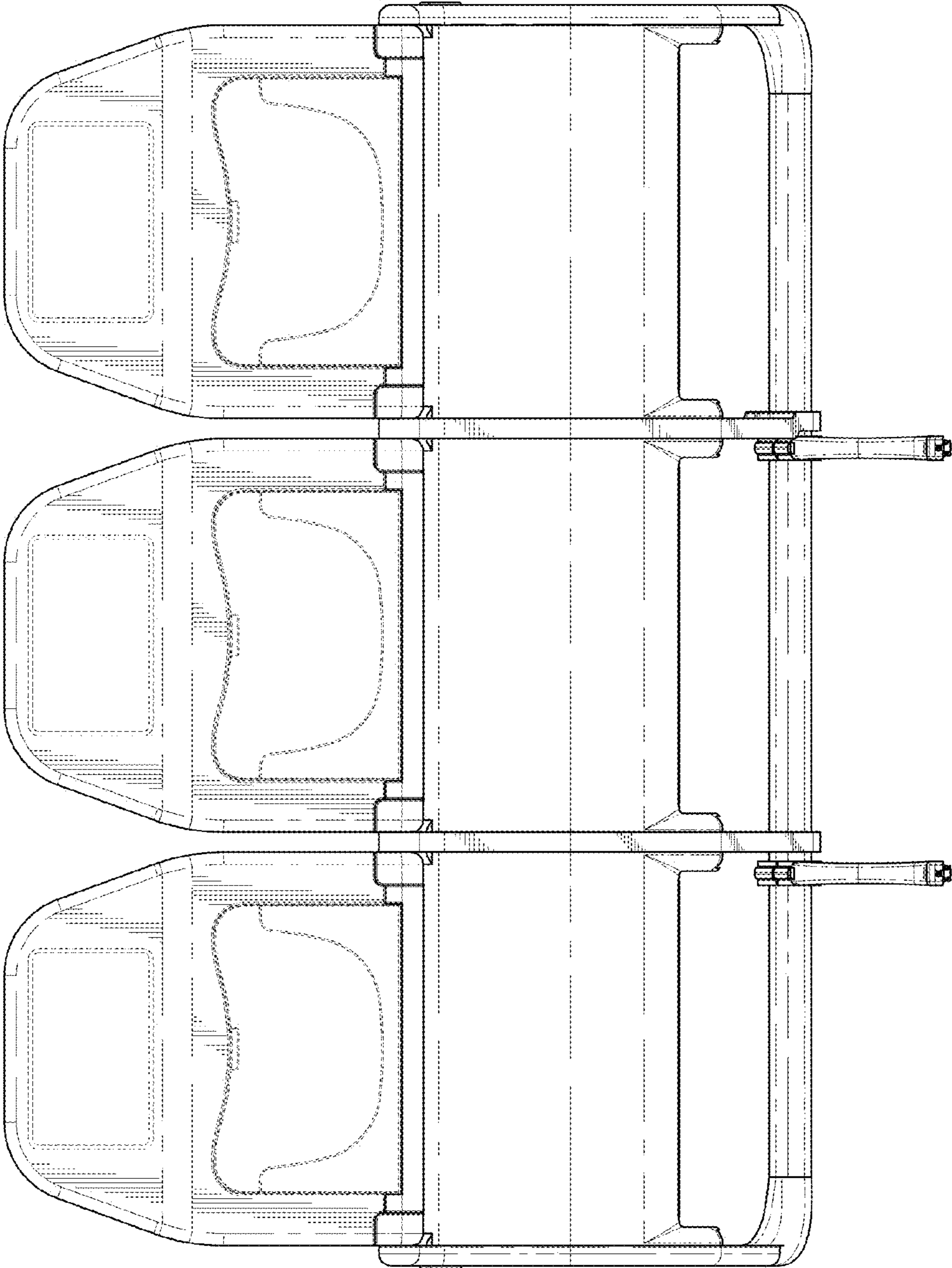

FIG. 3

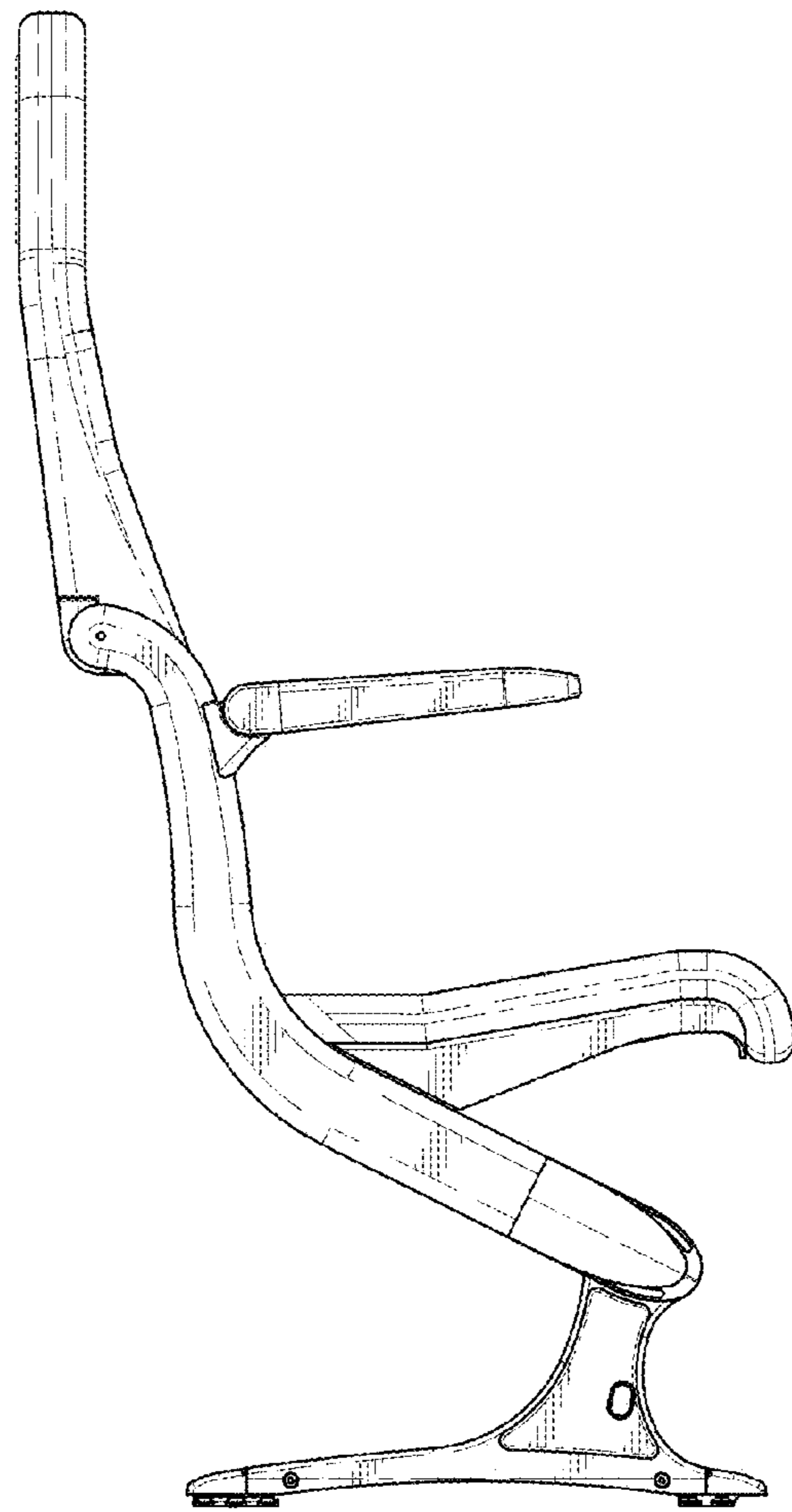

FIG. 4

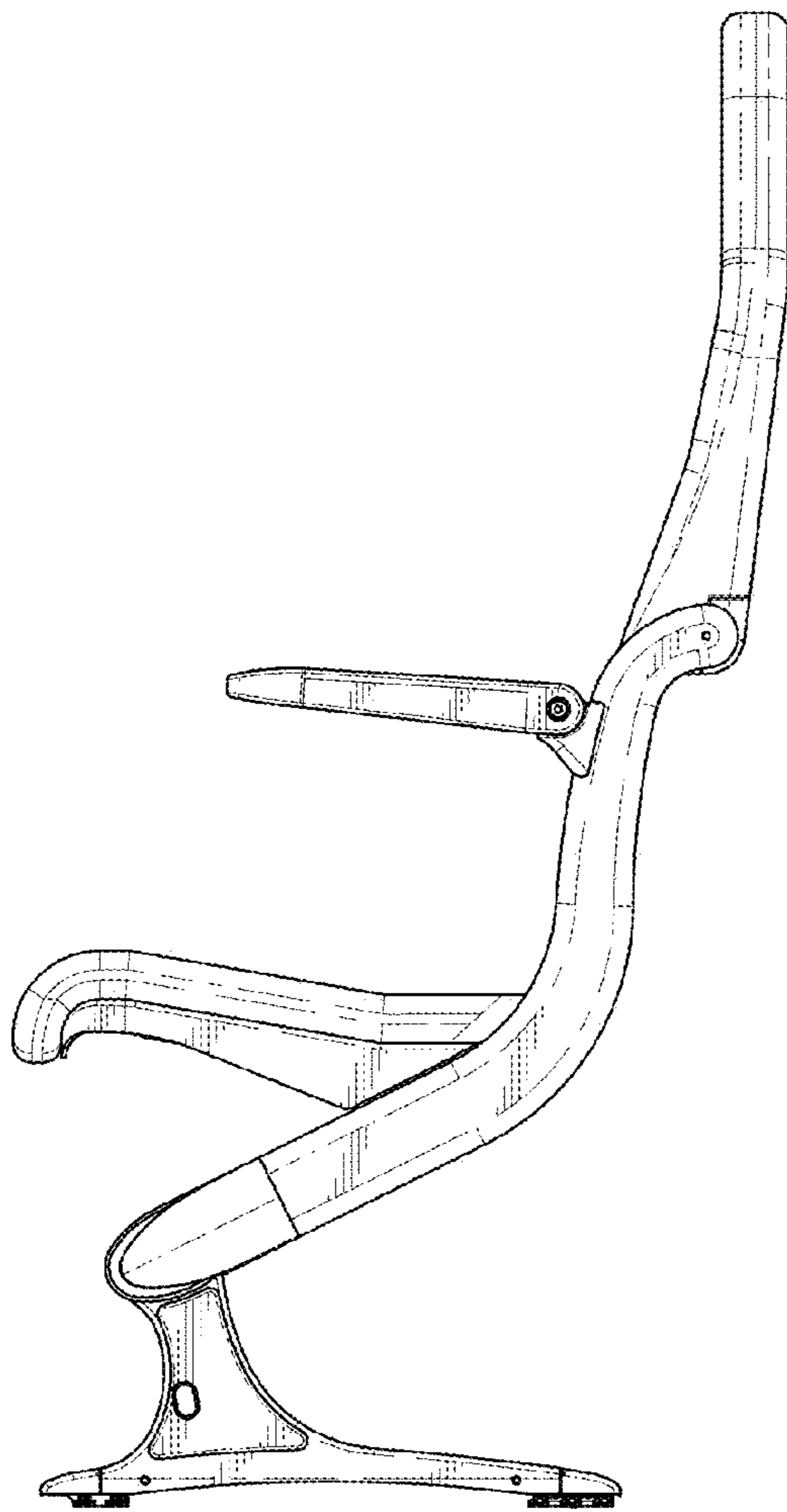

FIG. 5

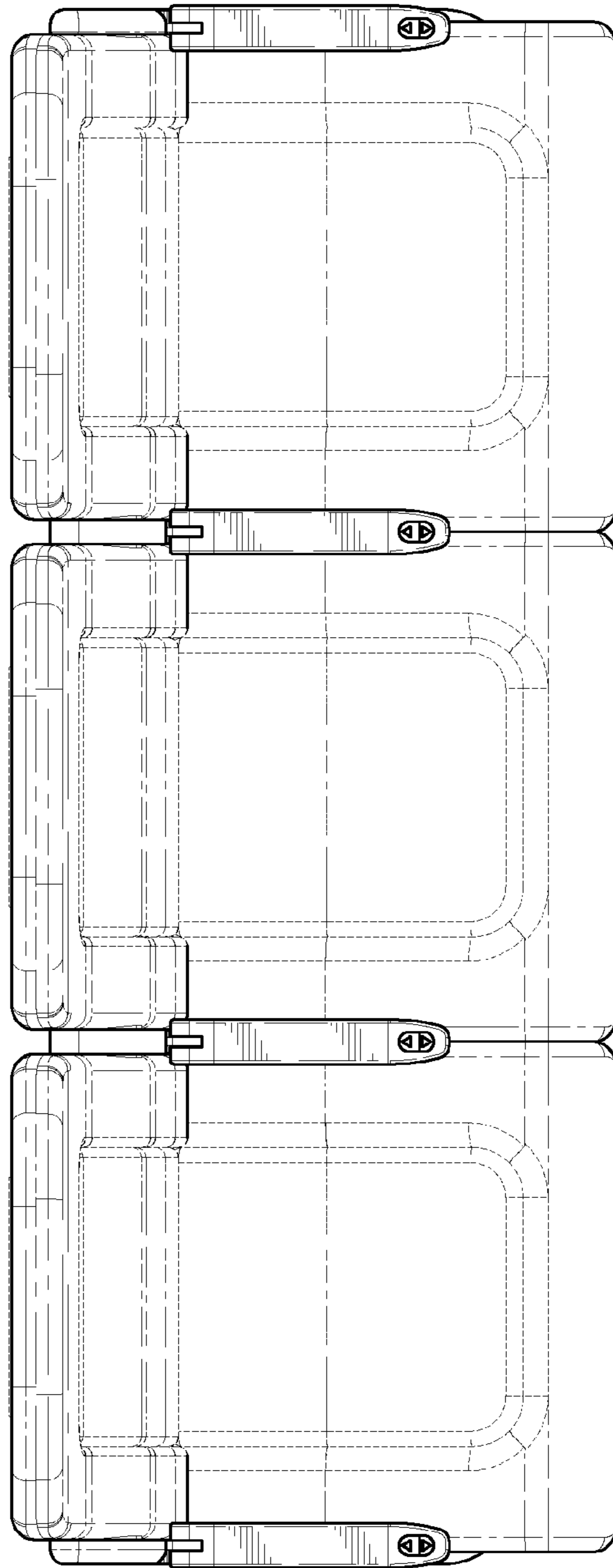

FIG. 6

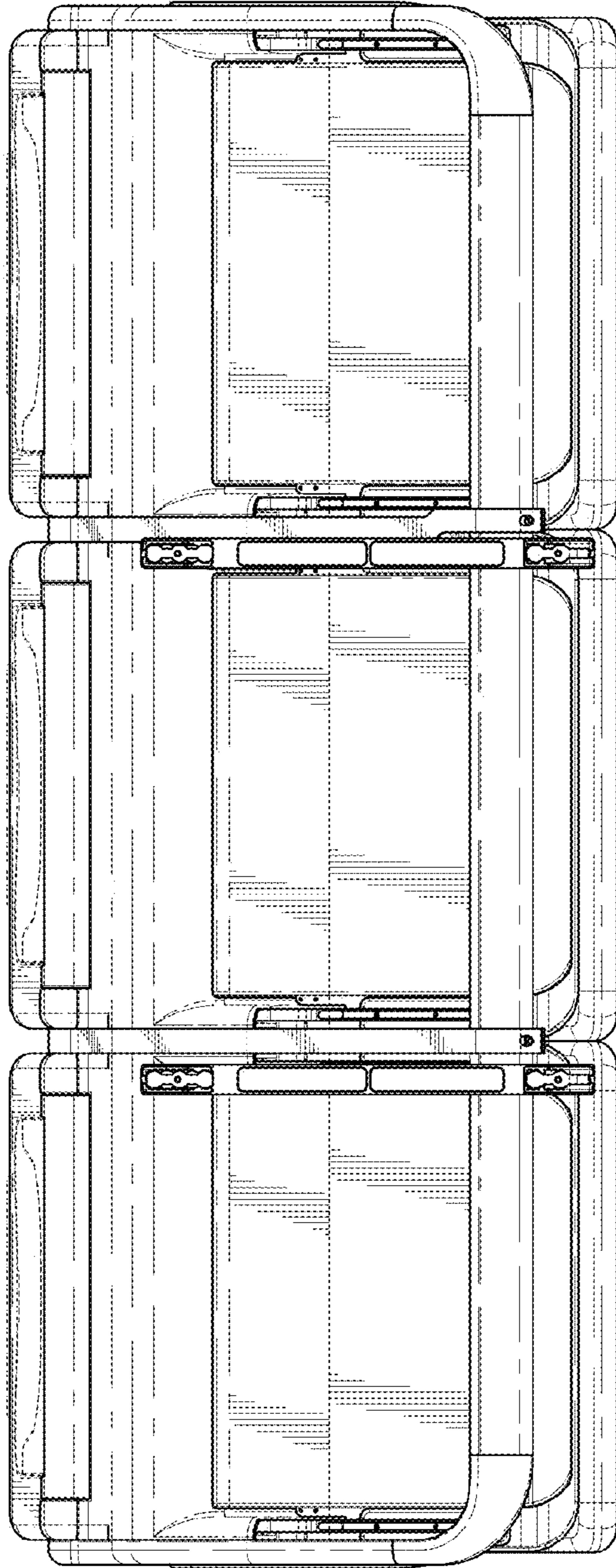

FIG. 7

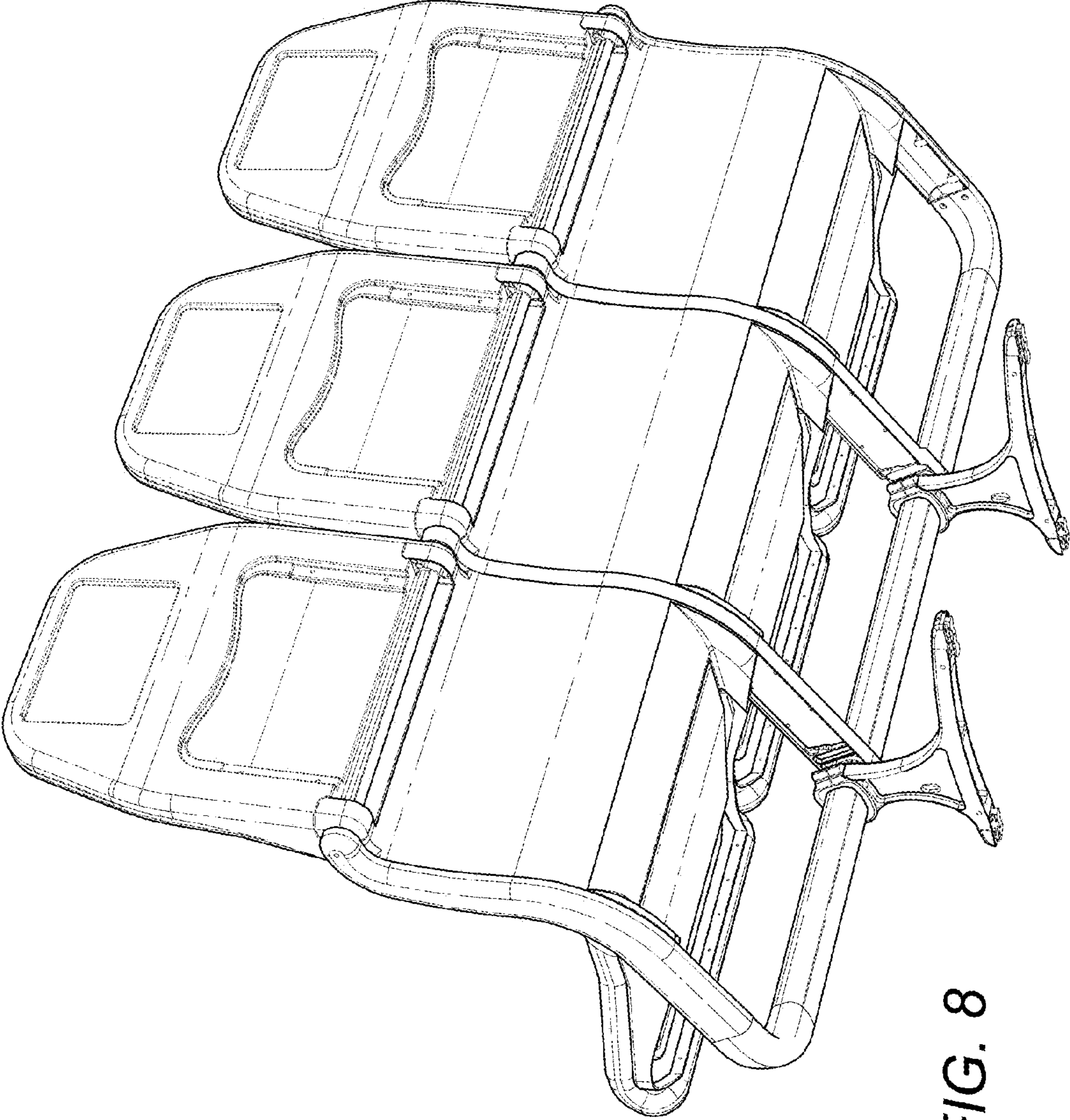

FIG. 8