



US00D686400S

(12) **United States Design Patent**  
**Portzline et al.**

(10) **Patent No.:** **US D686,400 S**  
(45) **Date of Patent:** **\*\* Jul. 23, 2013**

(54) **FOOTWEAR**

(75) Inventors: **William Scott Portzline**, Portland, OR (US); **John Joseph**, Portland, OR (US)

(73) Assignee: **Columbia Sportswear North America, Inc.**, Portland, OR (US)

(\*\*) Term: **14 Years**

(21) Appl. No.: **29/391,934**

(22) Filed: **May 13, 2011**

(51) **LOC (9) Cl.** ..... **02-04**

(52) **U.S. Cl.**  
USPC ..... **D2/957**; D2/951; D2/959; D2/960

(58) **Field of Classification Search**  
USPC ..... D2/902, 906, 908, 916, 918, 925,  
D2/946-962, 977; 36/3 B, 22 R, 24.5, 25 R,  
36/28, 32 R, 34 R, 59 C, 67 A, 103  
See application file for complete search history.

(56) **References Cited**

U.S. PATENT DOCUMENTS

D257,908 S *	1/1981	Inohara	.....	D2/962
D266,966 S *	11/1982	Inohara	.....	D2/908
4,375,728 A *	3/1983	Dassler	.....	36/32 R
D281,032 S *	10/1985	Austin	.....	D2/957
4,559,724 A *	12/1985	Norton	.....	36/129
D331,487 S *	12/1992	Arai	.....	D2/959
D334,654 S *	4/1993	May	.....	D2/954
D339,452 S *	9/1993	Hoshimi	.....	D2/954
D356,663 S *	3/1995	Ueda	.....	D2/902
D371,893 S *	7/1996	Kayano et al.	.....	D2/959
5,689,904 A *	11/1997	Kataoka et al.	.....	36/129
D400,346 S *	11/1998	Singer	.....	D2/959
5,906,872 A *	5/1999	Lyden et al.	.....	428/52
5,926,974 A *	7/1999	Friton	.....	36/28
D412,392 S *	8/1999	Singer	.....	D2/951
D416,670 S *	11/1999	Singer	.....	D2/955
D420,209 S *	2/2000	Singer	.....	D2/951

D420,496 S *	2/2000	Singer	.....	D2/951
D420,786 S *	2/2000	Ramer et al.	.....	D2/952
6,226,896 B1 *	5/2001	Friton	.....	36/28
6,289,611 B1 *	9/2001	Patterson et al.	.....	36/127
D477,129 S *	7/2003	Ramer	.....	D2/952
D509,950 S *	9/2005	Adams et al.	.....	D2/959
D558,434 S *	1/2008	Roth	.....	D2/959
D601,782 S *	10/2009	Cromley	.....	D2/906
D608,999 S *	2/2010	McClaskie	.....	D2/959
D643,196 S *	8/2011	Young	.....	D2/957
D644,826 S *	9/2011	Portzline	.....	D2/959
D662,695 S *	7/2012	Mcvicker et al.	.....	D2/902
D667,207 S *	9/2012	Funck	.....	D2/957
D667,621 S *	9/2012	Portzline	.....	D2/969
8,347,526 B2 *	1/2013	Goldston	.....	36/27
2009/0126230 A1 *	5/2009	McDonald et al.	.....	36/88
2011/0072687 A1 *	3/2011	Bobbett et al.	.....	36/127
2013/0019505 A1 *	1/2013	Borel	.....	36/103

\* cited by examiner

*Primary Examiner* — T. Chase Nelson

(74) *Attorney, Agent, or Firm* — Schwabe, Williamson & Wyatt, P.C.

(57) **CLAIM**

We claim the ornamental design for footwear, as shown and described.

**DESCRIPTION**

FIG. 1 is a perspective view of footwear, showing my new design;  
FIG. 2 is a front view thereof;  
FIG. 3 is a back view thereof;  
FIG. 4 is a left side view thereof;  
FIG. 5 is a right side view thereof;  
FIG. 6 is a top view thereof; and,  
FIG. 7 is a bottom thereof.

The dashed lines are included for illustrating environmental structure and form no part of the claimed design.

**1 Claim, 6 Drawing Sheets**

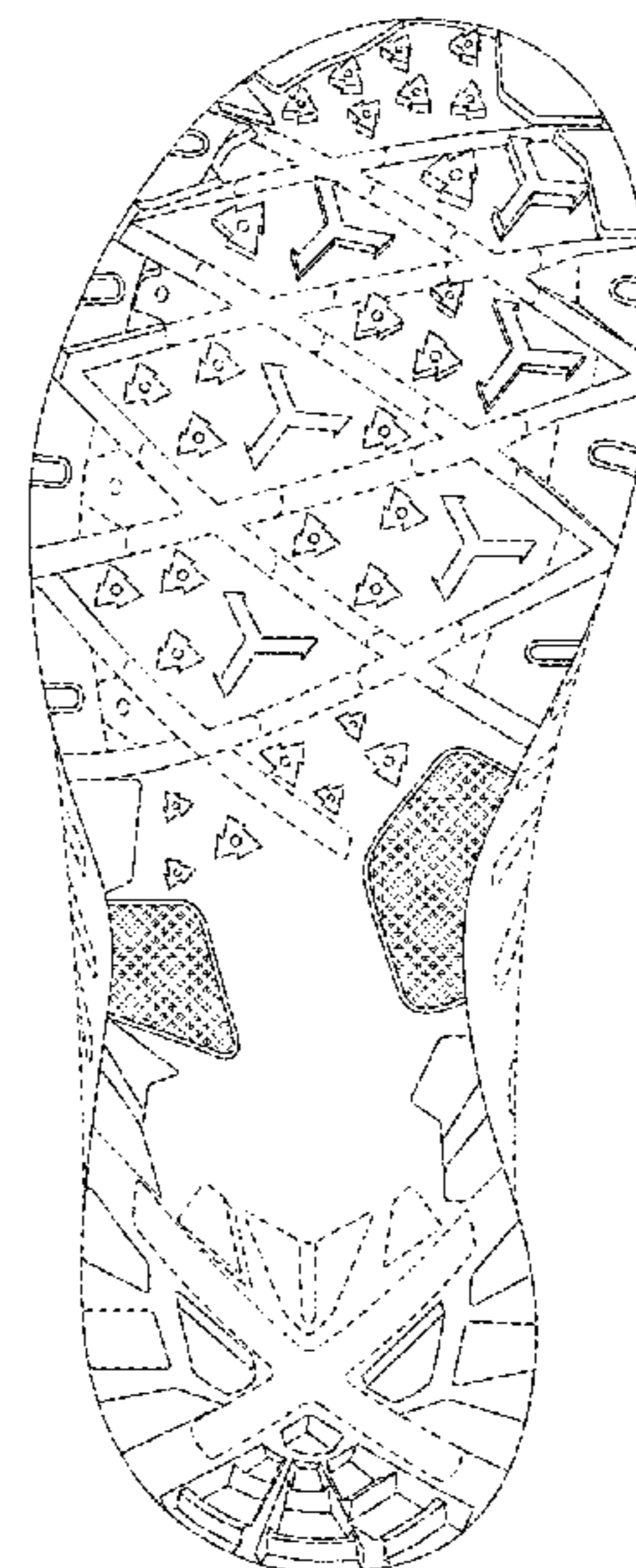
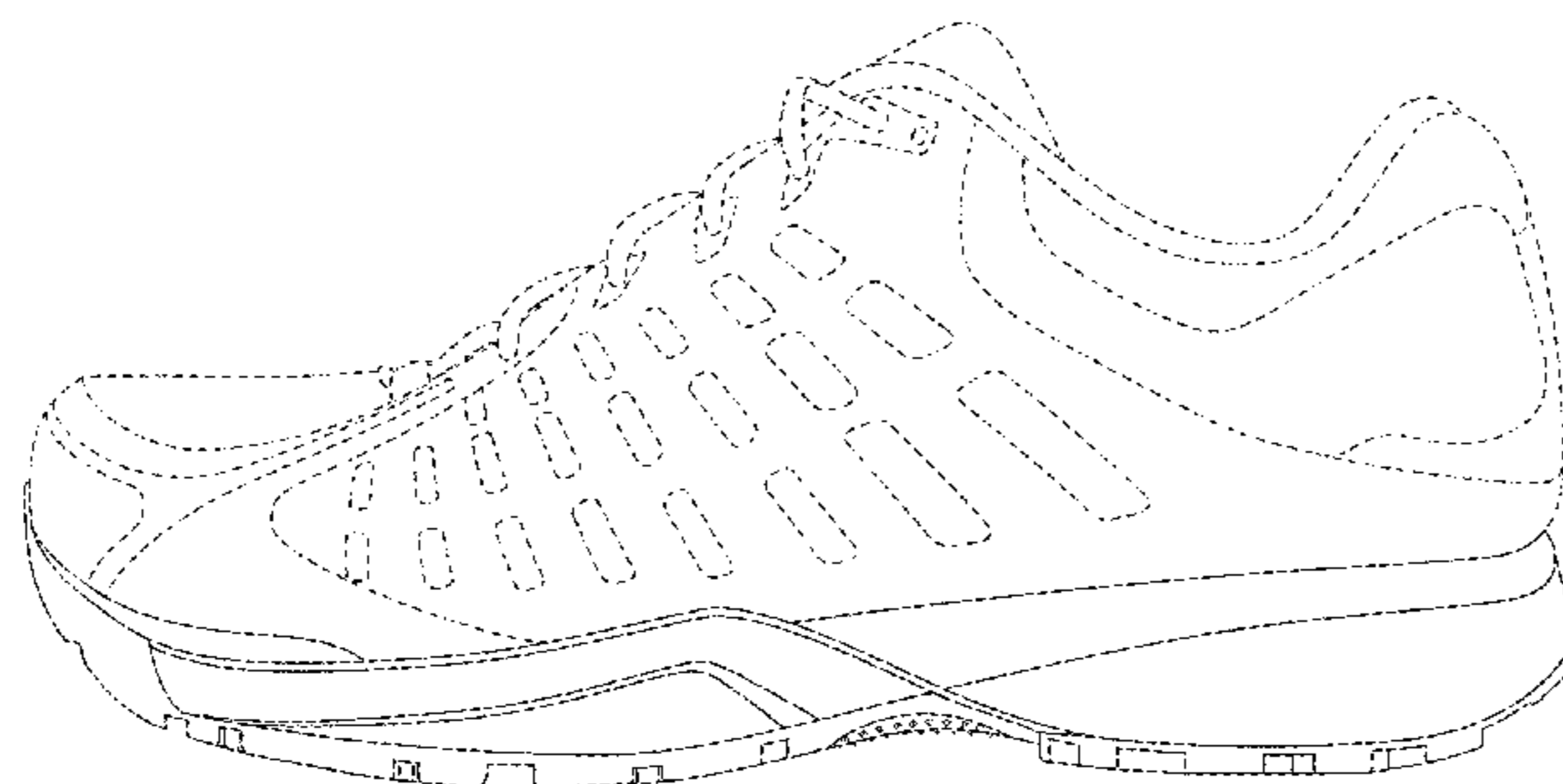

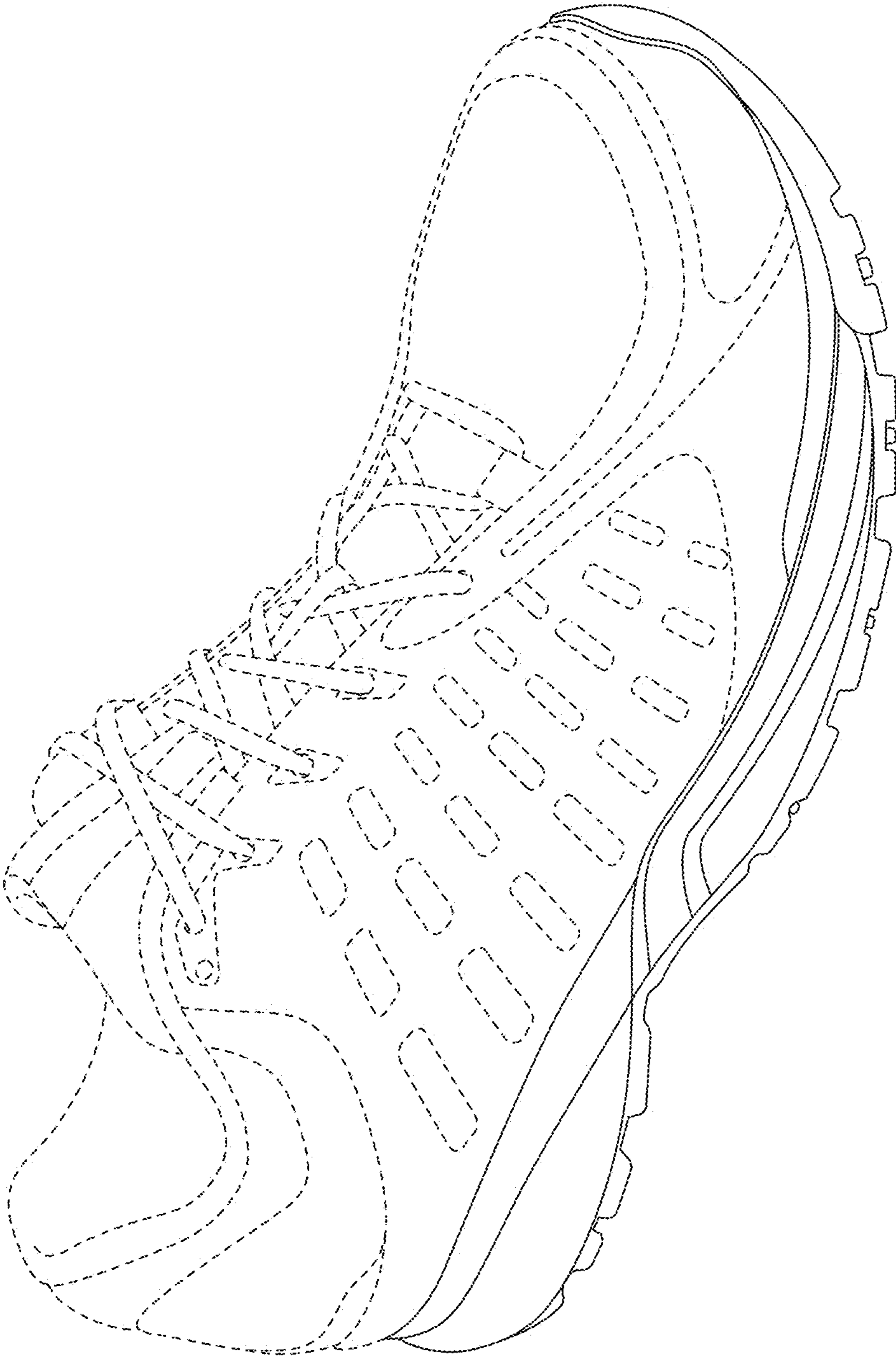

FIG. 1

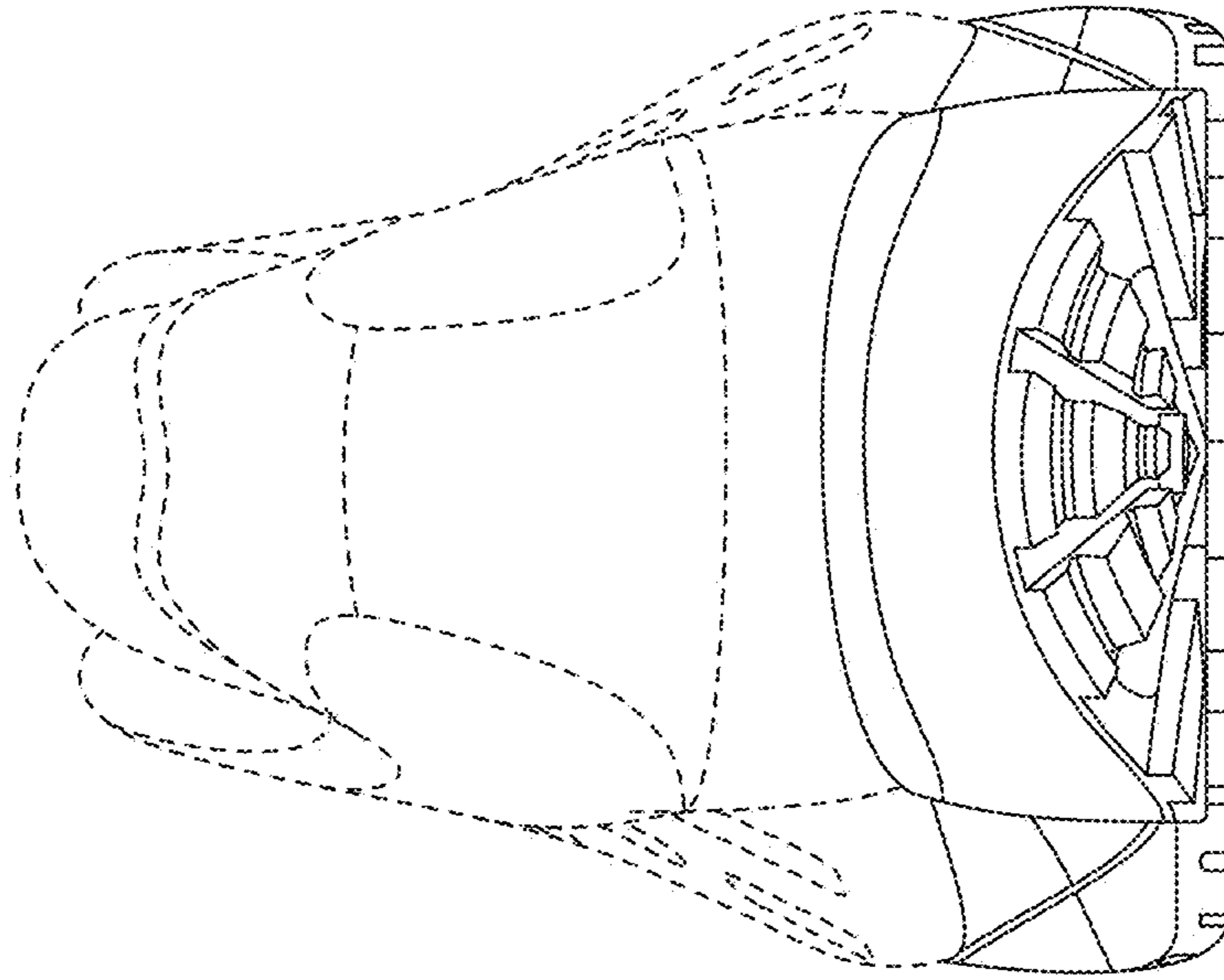

FIG. 2

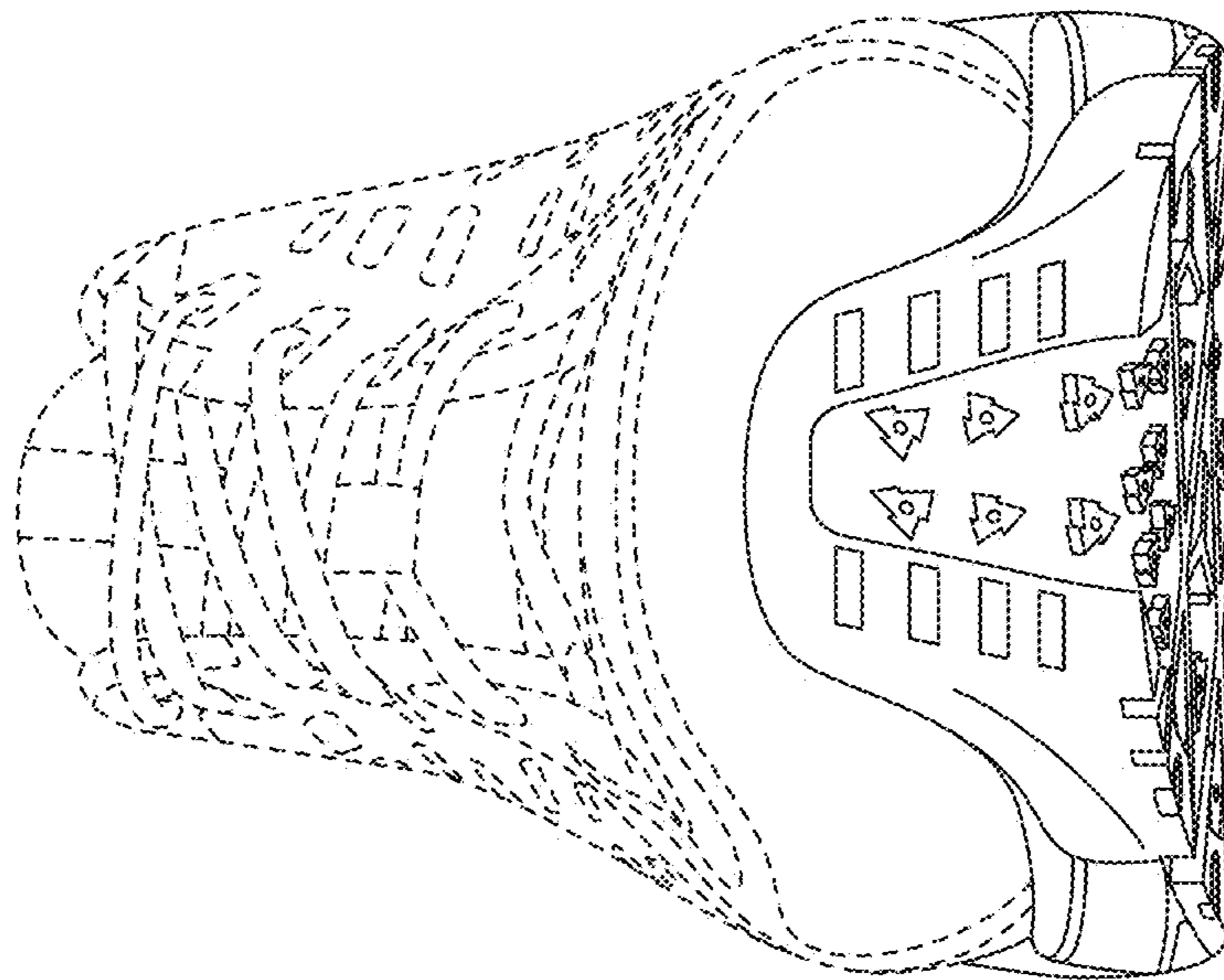

FIG. 3

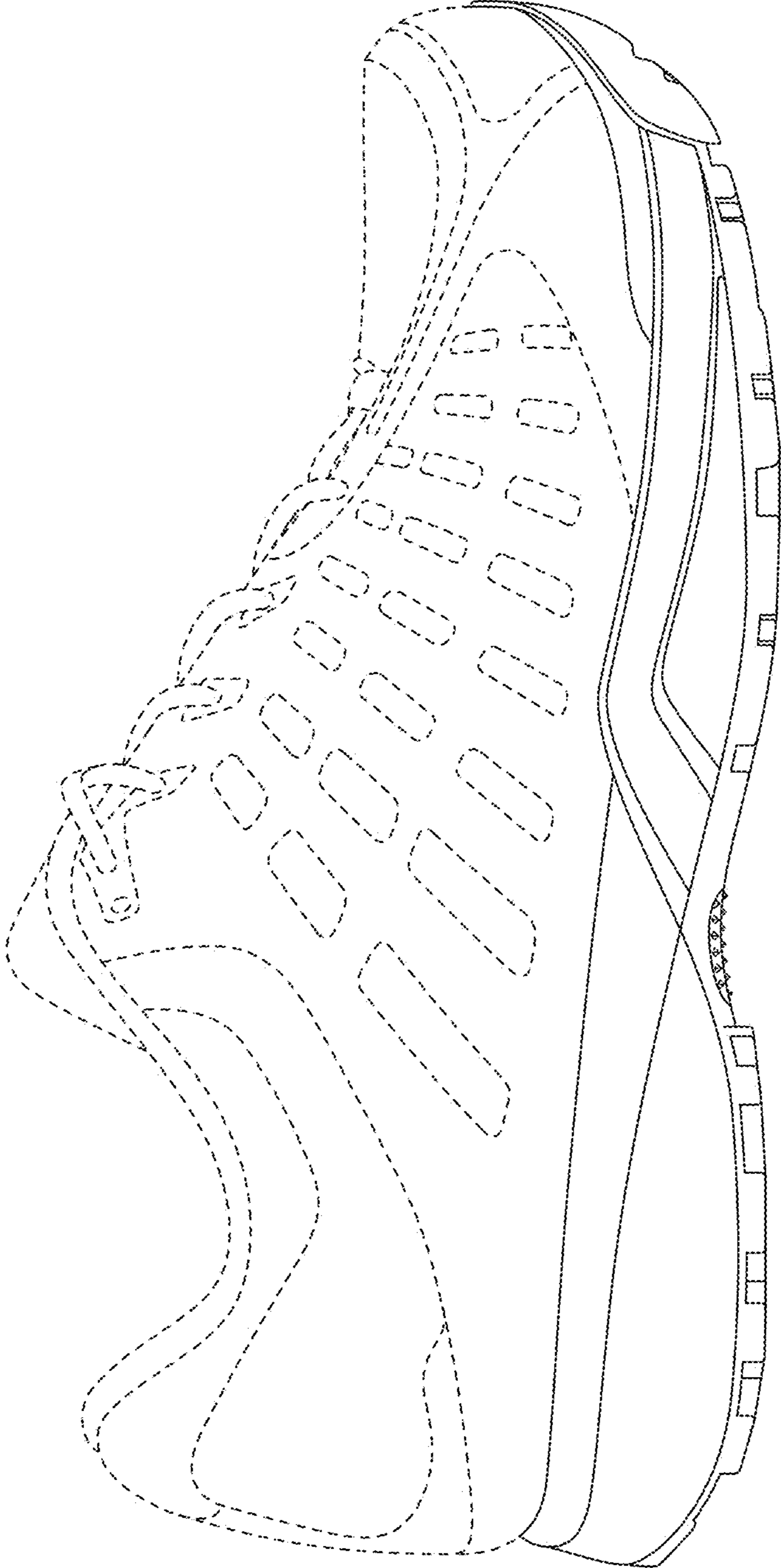

FIG. 4

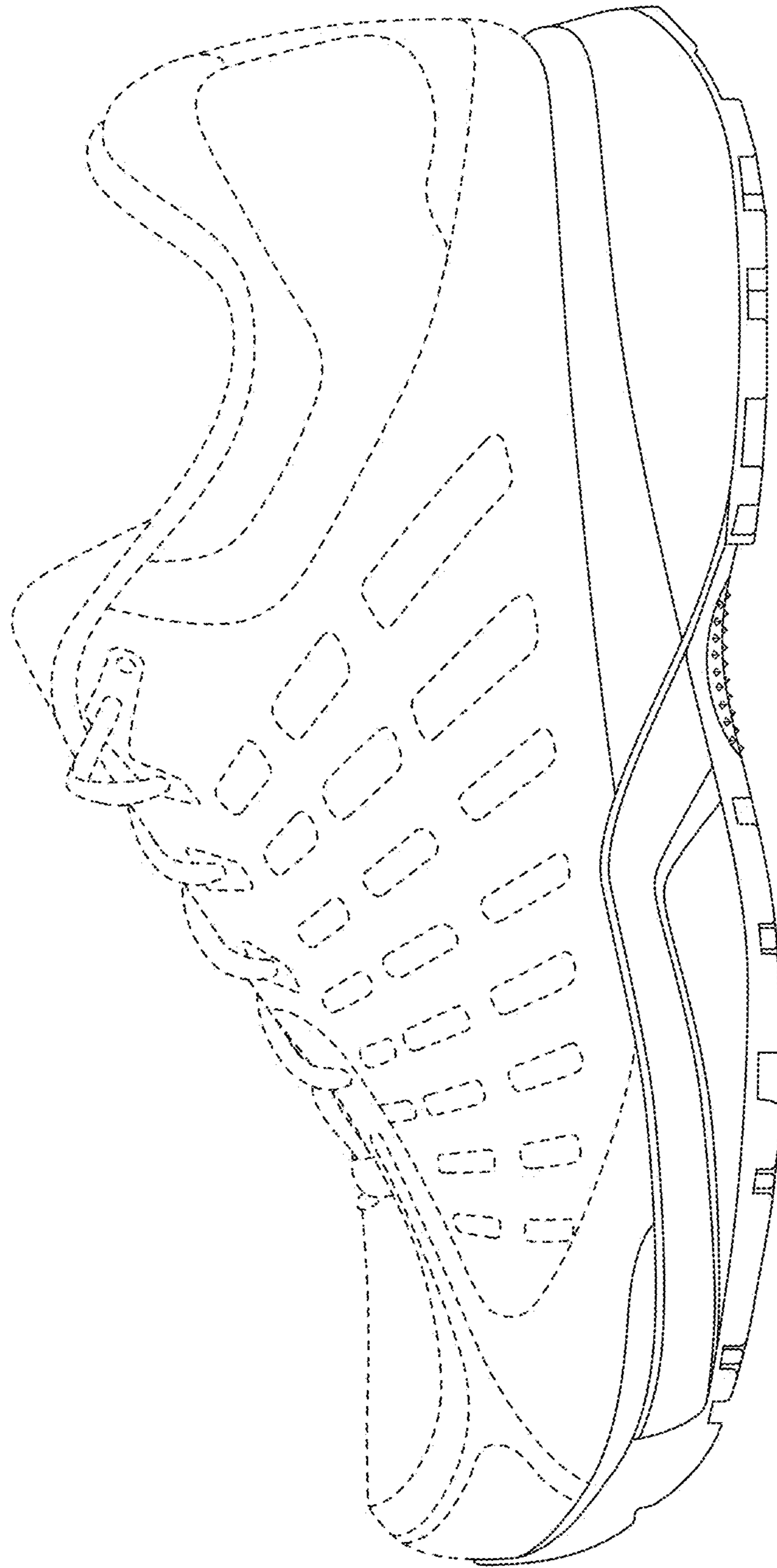

FIG. 5

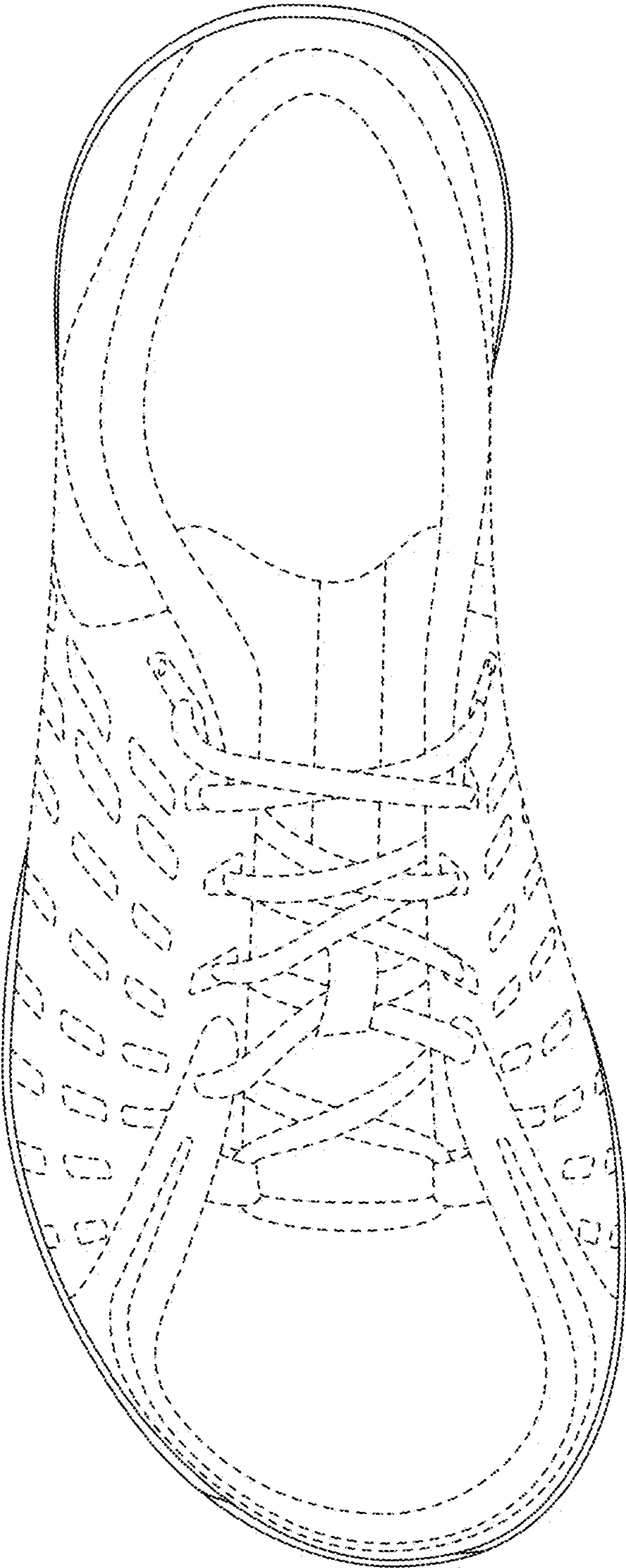

FIG. 6

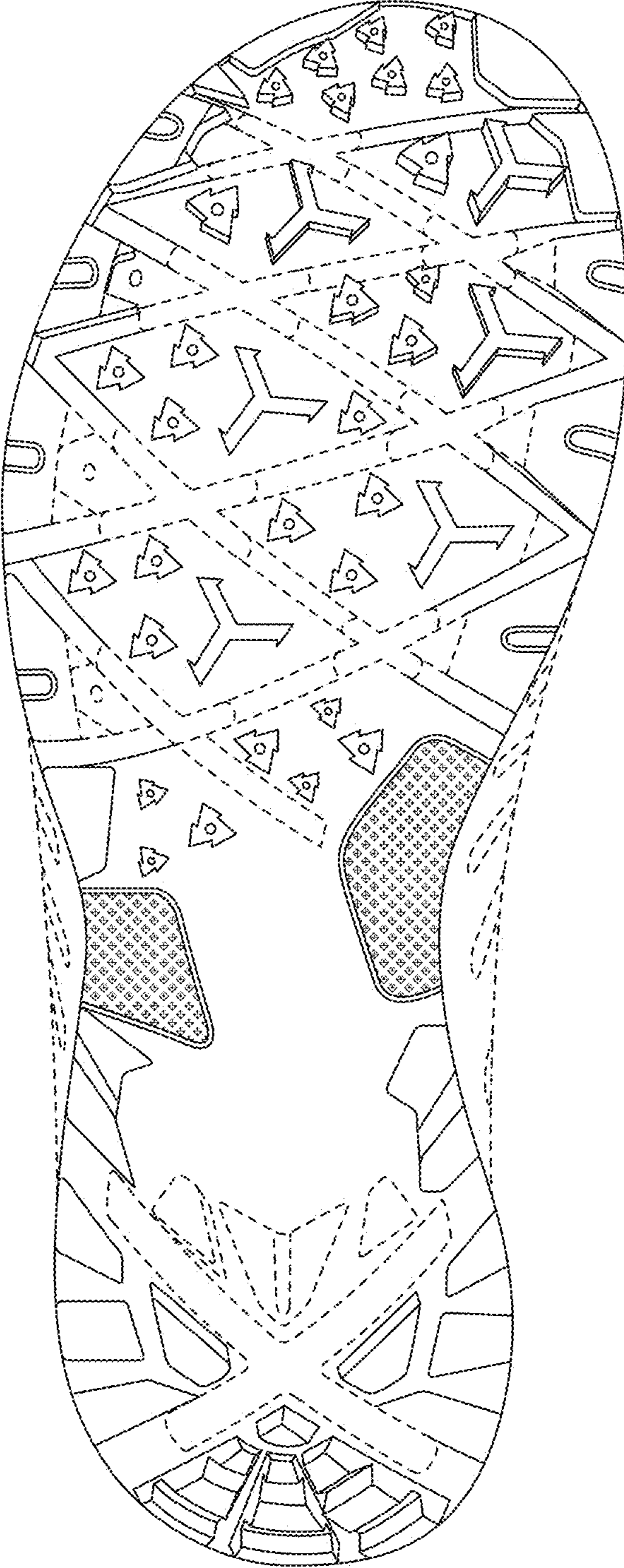

FIG. 7