



US00D686276S

(12) **United States Design Patent**
Kurihara et al.

(10) **Patent No.:** **US D686,276 S**
(45) **Date of Patent:** **** Jul. 16, 2013**

(54) **CREAM SOLDER PRINTER**
(75) Inventors: **Hirokuni Kurihara**, Inashiki (JP);
Takao Kawano, Shunan (JP); **Tomoyuki**
Yahagi, Ryugasaki (JP); **Makoto**
Homma, Katori (JP)

(73) Assignee: **Hitachi Plant Technologies, Ltd.**,
Tokyo (JP)

(**) Term: **14 Years**

(21) Appl. No.: **29/429,046**

(22) Filed: **Aug. 7, 2012**

(30) **Foreign Application Priority Data**

Feb. 13, 2012 (JP) 2012-002942

(51) **LOC (9) Cl.** **18-02**

(52) **U.S. Cl.**
USPC **D18/53**

(58) **Field of Classification Search**
USPC D18/53, 50, 55, 56, 59, 36-39, 46-49;
D14/301, 303; D15/122, 135, 136, 141,
144-144.2; 270/1.01; 271/8.1; 101/2; 358/1.1;
355/78; 399/361

See application file for complete search history.

(56) **References Cited**

U.S. PATENT DOCUMENTS

D312,267 S * 11/1990 Biggs et al. D18/39
5,372,066 A * 12/1994 Proctor 101/118
D363,735 S * 10/1995 Karafuji et al. D18/53
D370,496 S * 6/1996 Inoue et al. D18/50
D425,108 S * 5/2000 Kabumoto et al. D18/38

6,256,876 B1 * 7/2001 Ohe et al. 29/832
6,266,869 B1 * 7/2001 Tracy et al. 29/740
6,490,781 B2 * 12/2002 Kanai et al. 29/708
D493,808 S * 8/2004 Tanaka et al. D15/199
D494,988 S * 8/2004 Tanaka et al. D15/199
D588,188 S * 3/2009 Minakawa et al. D18/39
D614,233 S * 4/2010 Kemmochi et al. D18/53
D648,783 S * 11/2011 Mathea D18/53

FOREIGN PATENT DOCUMENTS

CN RGN 3628875 * 4/2007
CN RGN 301013463 * 9/2009
CN RGN 302300060 * 8/2012

* cited by examiner

Primary Examiner — Bridget L Eland

(74) *Attorney, Agent, or Firm* — Antonelli, Terry, Stout & Kraus, LLP.

(57) **CLAIM**

We claim the ornamental design for a cream solder printer, as shown and described.

DESCRIPTION

FIG. 1 is a front, top and left side perspective view of an cream solder printer showing our new design;
FIG. 2 is a front side elevational view thereof;
FIG. 3 is a rear side elevational view thereof;
FIG. 4 is a right side elevational view thereof;
FIG. 5 is a left side elevational view thereof.;
FIG. 6 is a top plan view thereof;
FIG. 7 is a bottom plan view thereof; and,
FIG. 8 is a right side view in which the door was opened.
The broken line showing is directed to environment and is for illustrative purposes only; the broken lines form no part of the claimed design.

1 Claim, 7 Drawing Sheets

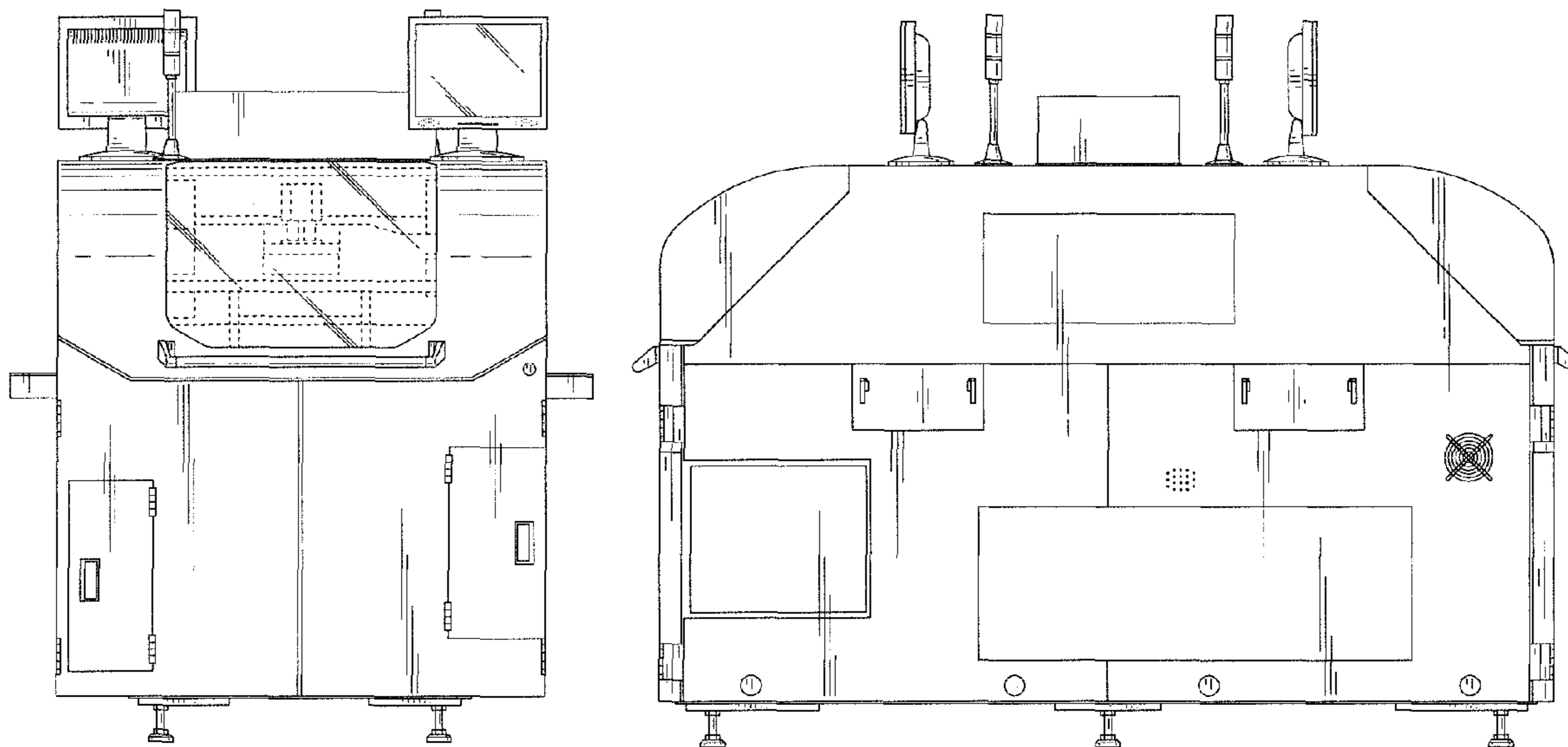

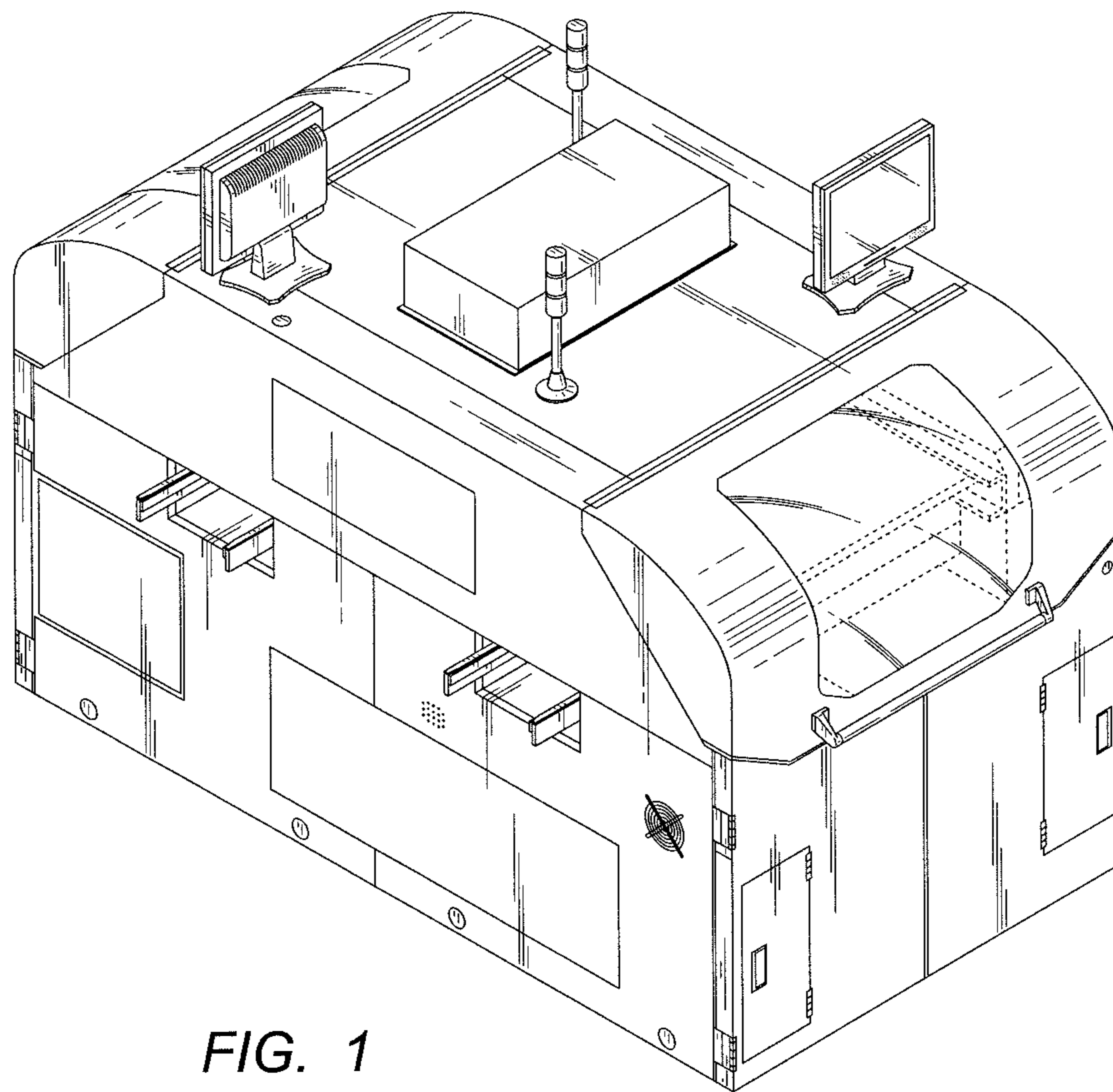

FIG. 1

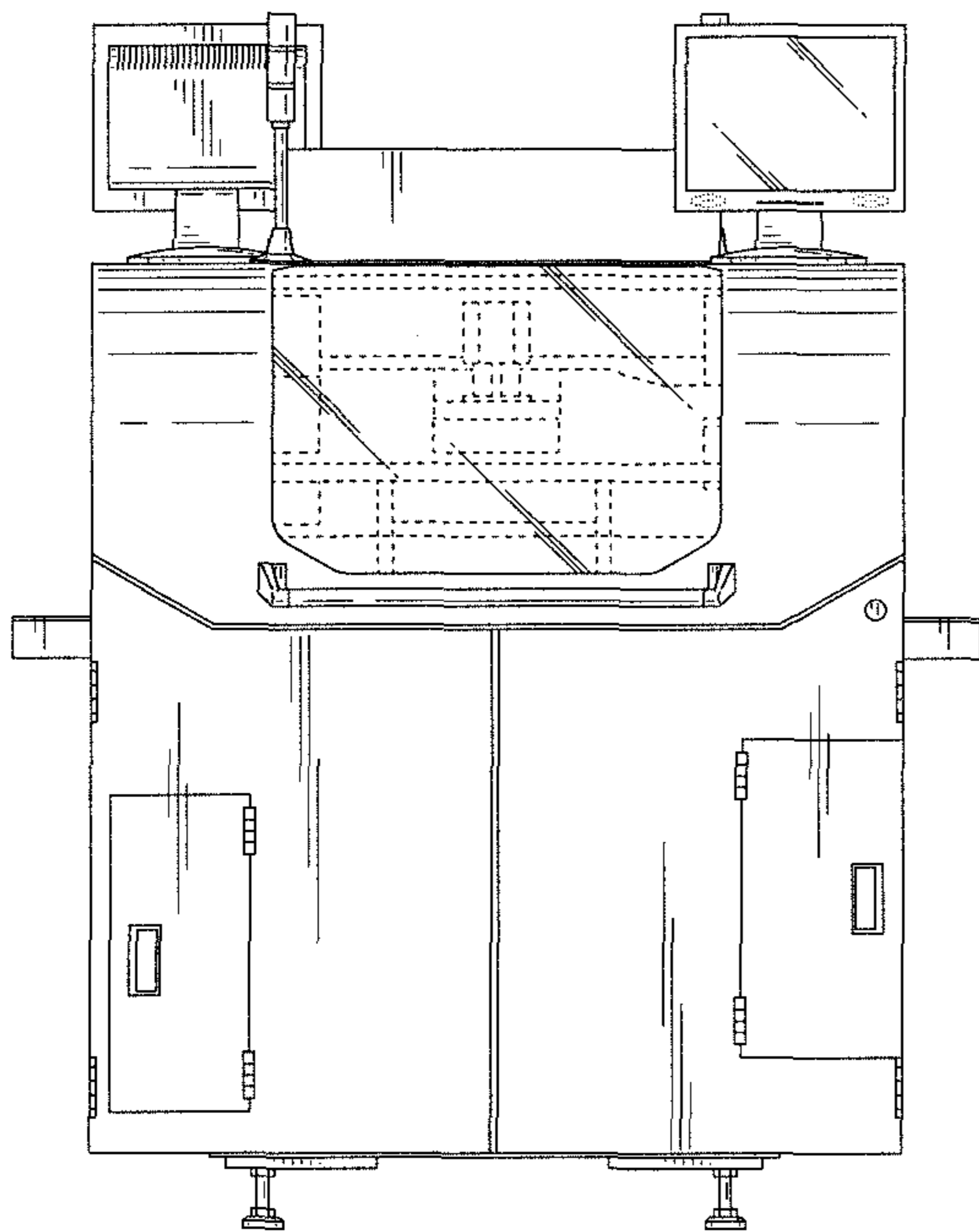

FIG. 2

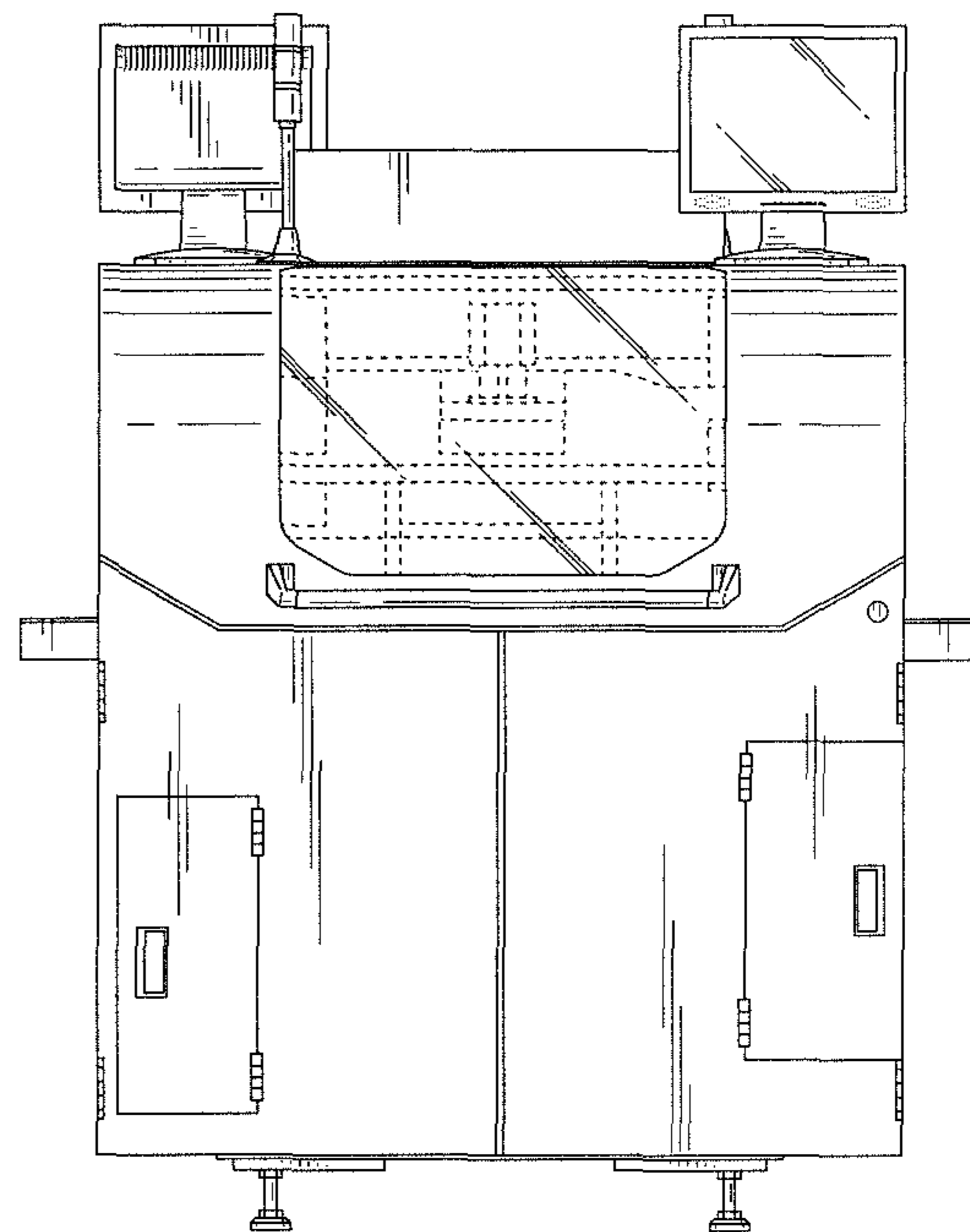

FIG. 3

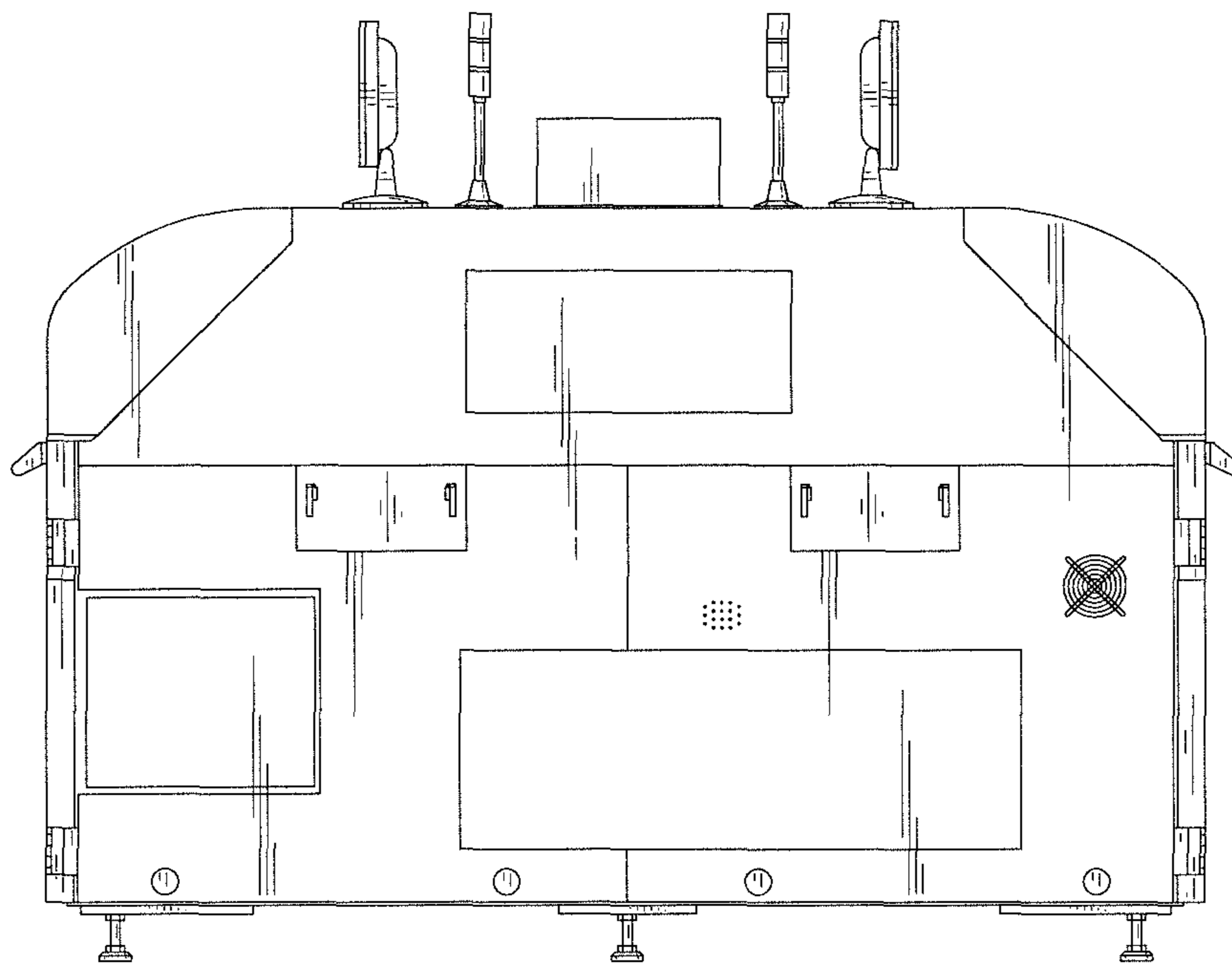

FIG. 4

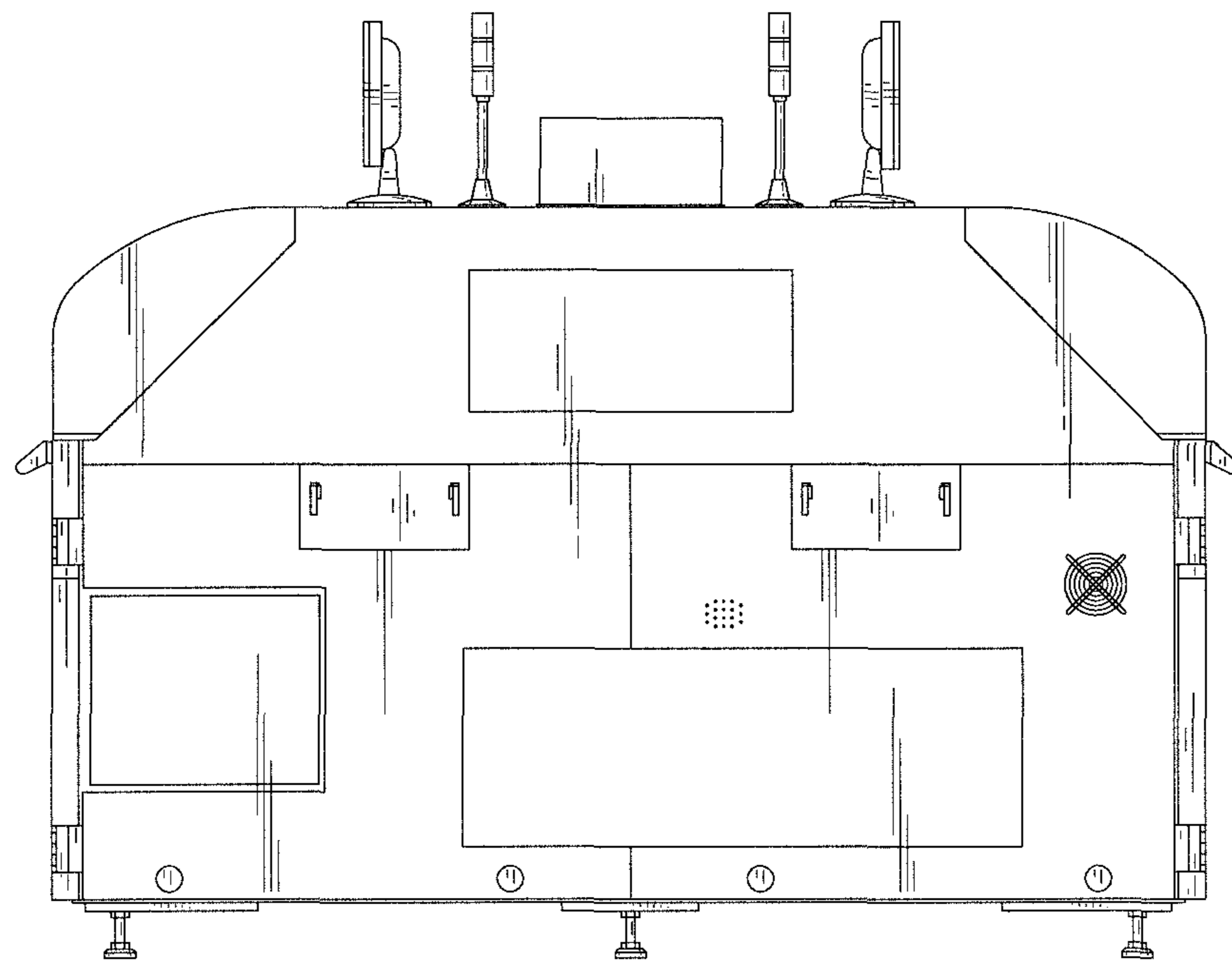

FIG. 5

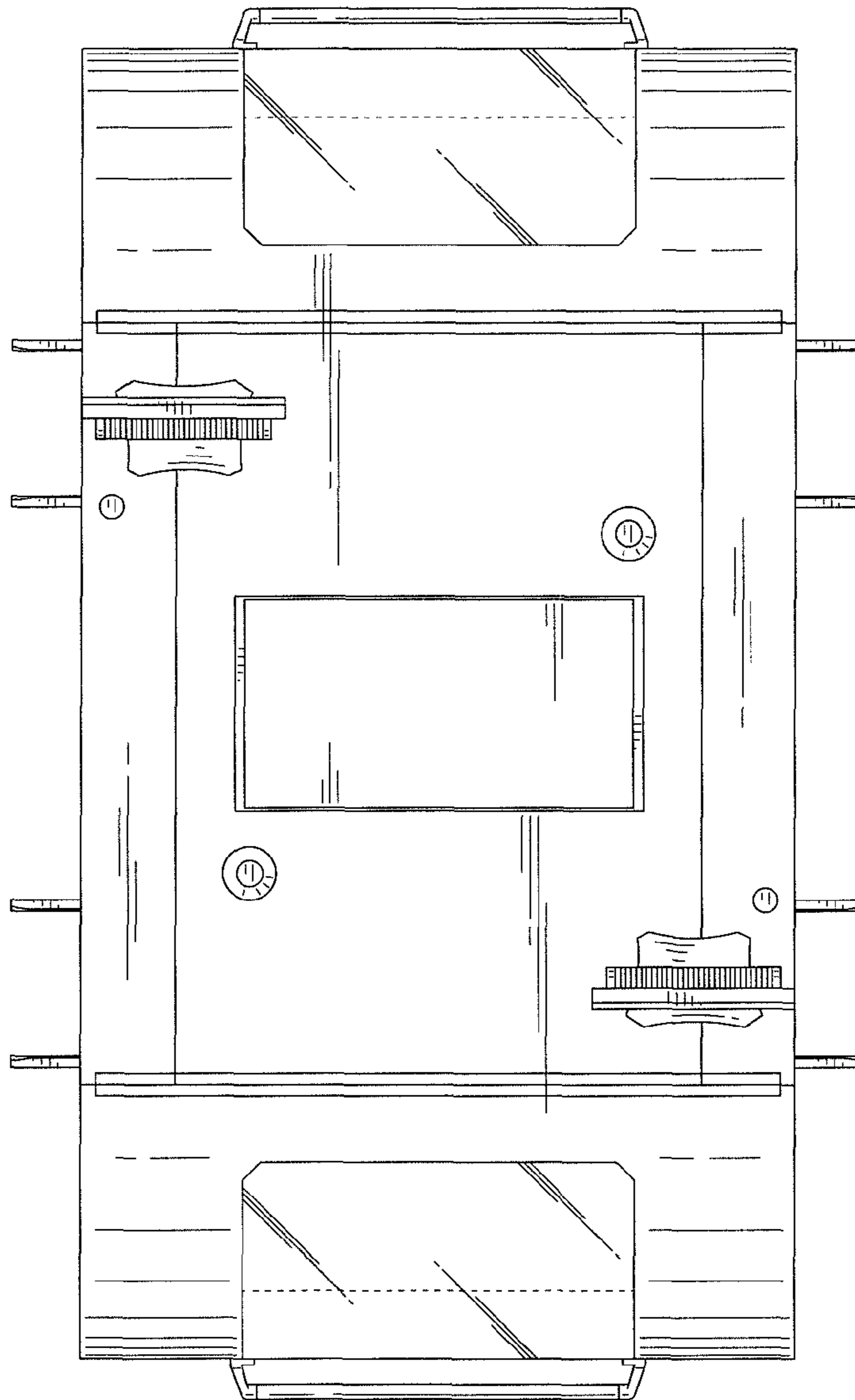

FIG. 6

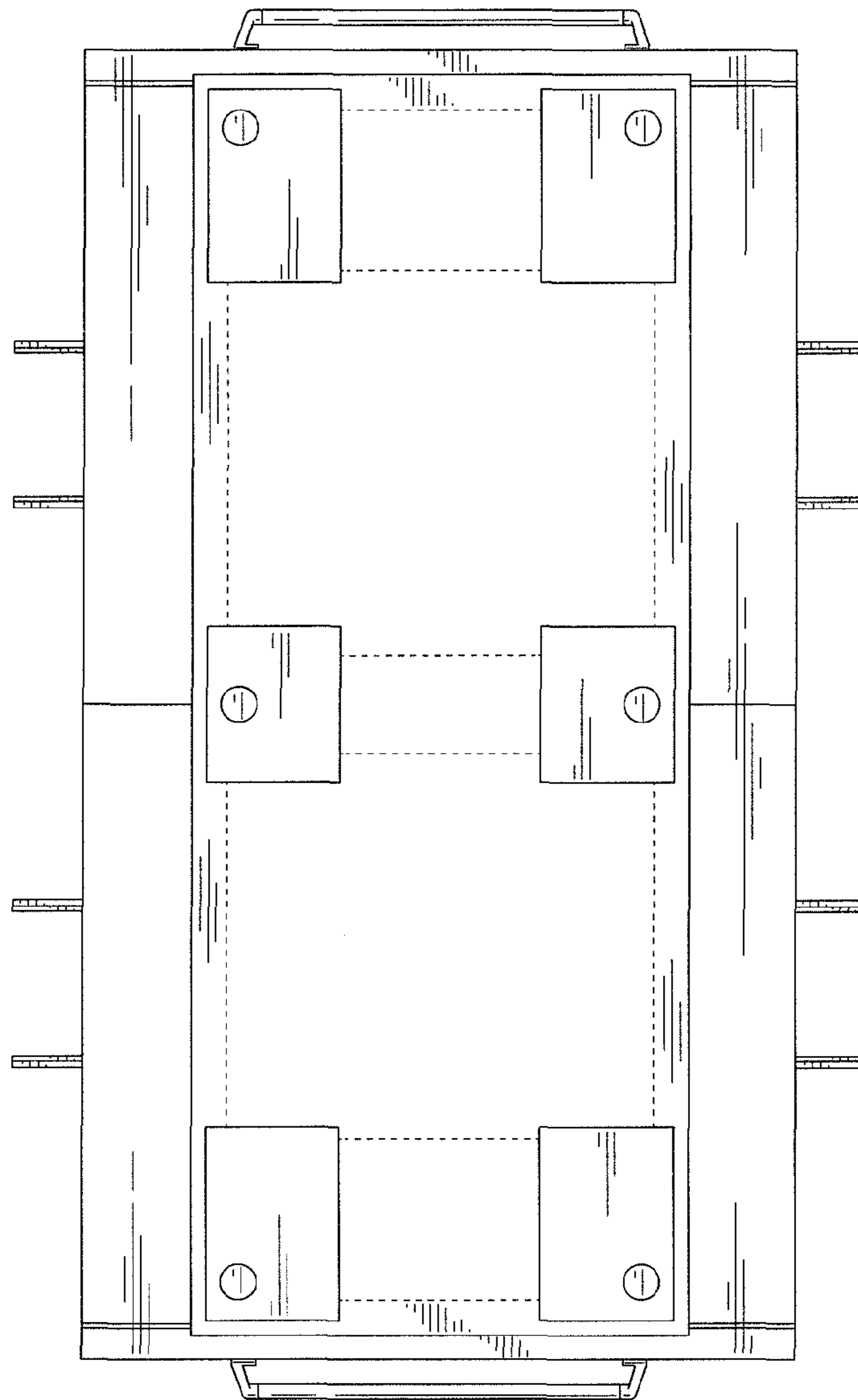

FIG. 7

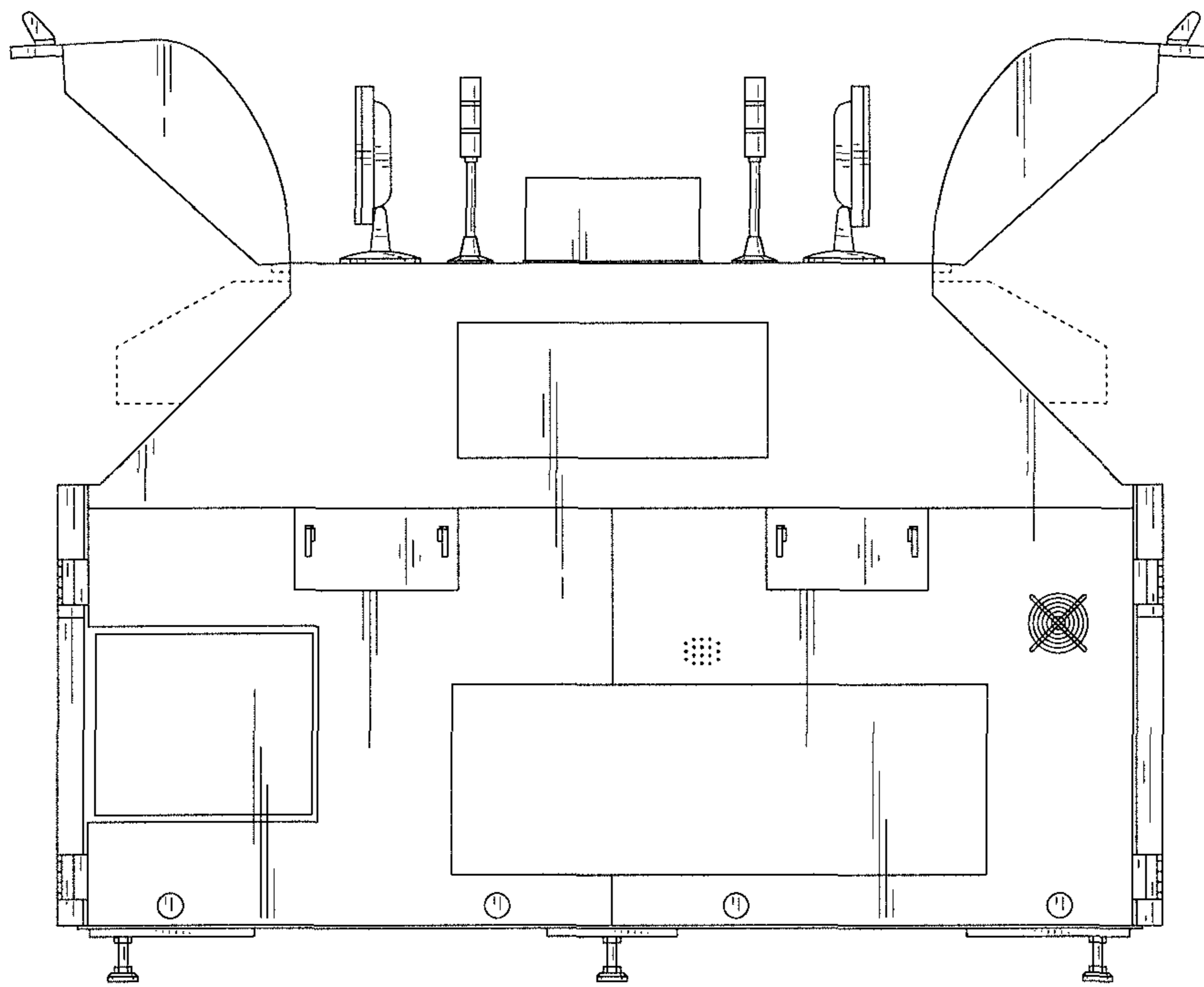

FIG. 8