



US00D686223S

(12) **United States Design Patent**
Gardner et al.

(10) **Patent No.:** **US D686,223 S**
(45) **Date of Patent:** **** Jul. 16, 2013**

(54) **DISPLAY SCREEN WITH ANIMATED GRAPHICAL USER INTERFACE**

(75) Inventors: **David Gardner**, Covington, WA (US);
Colin Michael Riley, Seattle, WA (US)

(73) Assignee: **Microsoft Corporation**, Redmond, WA (US)

(**) Term: **14 Years**

(21) Appl. No.: **29/406,953**

(22) Filed: **Nov. 21, 2011**

(51) **LOC (9) Cl.** **14-02**

(52) **U.S. Cl.**
USPC **D14/486**

(58) **Field of Classification Search**
USPC D14/485-495; 715/700-867
See application file for complete search history.

(56) **References Cited**

U.S. PATENT DOCUMENTS

6,185,476	B1 *	2/2001	Sakai	700/182
6,268,854	B1 *	7/2001	Borden et al.	715/786
D545,828	S	7/2007	Vong et al.	
D546,335	S	7/2007	Vong et al.	
D546,336	S	7/2007	Vong et al.	
D556,767	S *	12/2007	Morris	D14/487
D556,768	S *	12/2007	Morris	D14/487
D556,769	S *	12/2007	Morris	D14/487
D599,363	S	9/2009	Mays	
D599,364	S	9/2009	Mays	
D599,365	S	9/2009	Brown et al.	
D599,366	S	9/2009	Brown et al.	
D599,367	S	9/2009	Mays et al.	
D599,368	S	9/2009	Kanga et al.	
D622,730	S	8/2010	Krum et al.	
D627,361	S	11/2010	Lew et al.	
D627,363	S	11/2010	Lew	
D629,417	S	12/2010	Weir et al.	
D641,372	S *	7/2011	Gardner et al.	D14/486

(Continued)

Primary Examiner — Deanna L Fluegeman

(74) *Attorney, Agent, or Firm* — Banner & Witcoff, Ltd.

(57) **CLAIM**

The ornamental design for a display screen with animated graphical user interface, as shown and described.

DESCRIPTION

FIG. 1 is a front view of a display screen with animated graphical user interface showing the new design; and FIG. 2 is the second image thereof; FIG. 3 is the third image thereof; FIG. 4 is the fourth image thereof; FIG. 5 is the fifth image thereof; FIG. 6 is the sixth image thereof; FIG. 7 is the seventh image thereof; FIG. 8 is the eighth image thereof; FIG. 9 is the ninth image thereof; FIG. 10 is the tenth image thereof; FIG. 11 is the eleventh image thereof; FIG. 12 is the twelfth image thereof; FIG. 13 is the thirteenth image thereof; FIG. 14 is the fourteenth image thereof; FIG. 15 is the fifteenth image thereof; FIG. 16 is the sixteenth image thereof; FIG. 17 is the seventeenth image thereof; FIG. 18 is the eighteenth image thereof; FIG. 19 is the nineteenth image thereof; FIG. 20 is the twentieth image thereof; FIG. 21 is the twenty-first image thereof; FIG. 22 is the twenty-second image thereof; and, FIG. 23 is the twenty-third image thereof.

The appearance of the transitional image sequentially transitions between the images shown in FIGS. 1-23. The process or period in which one image transitions to another image forms no part of the claimed design. The broken line showing of the rectangles and the remainder of the display screen is for environmental purposes only and forms no part of the claimed design.

1 Claim, 23 Drawing Sheets

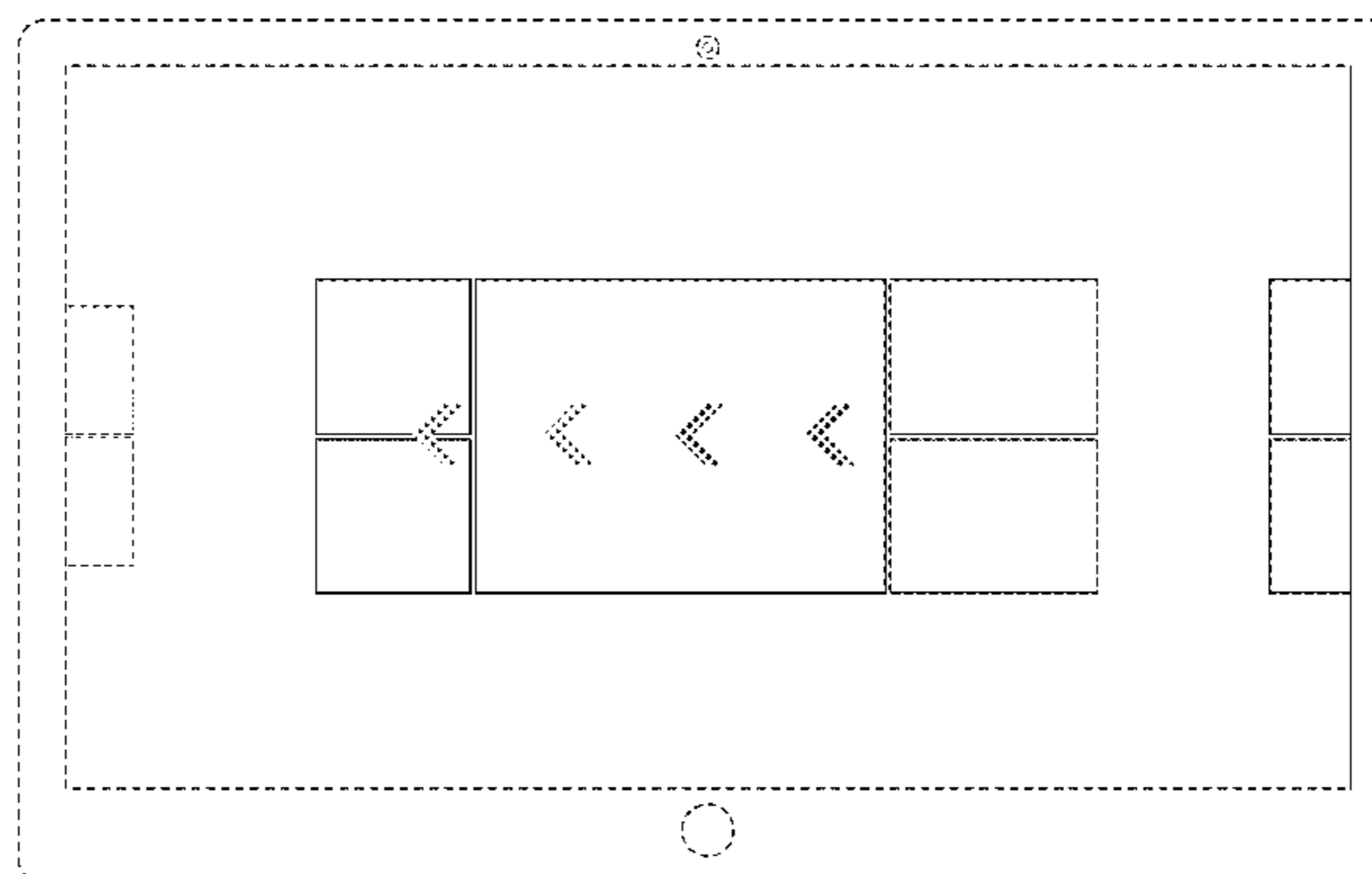
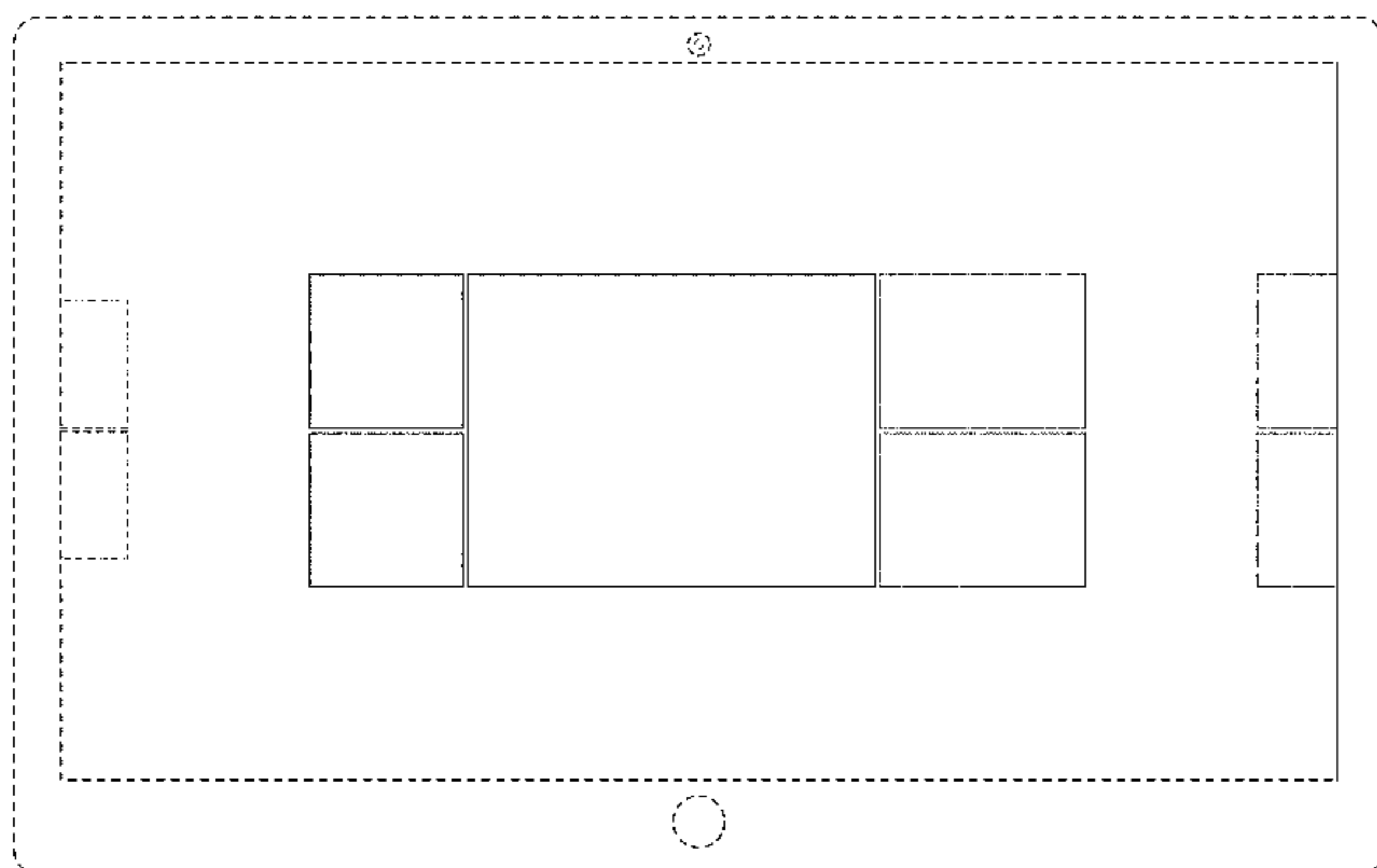

US D686,223 S

Page 2

U.S. PATENT DOCUMENTS

D641,373 S *	7/2011	Gardner et al.	D14/486	D644,662 S *	9/2011	Gardner et al.	D14/495
D643,438 S *	8/2011	Gardner et al.	D14/486	D644,663 S *	9/2011	Gardner et al.	D14/495
D644,661 S *	9/2011	Gardner et al.	D14/495	D645,469 S	9/2011	Gardner et al.		

* cited by examiner

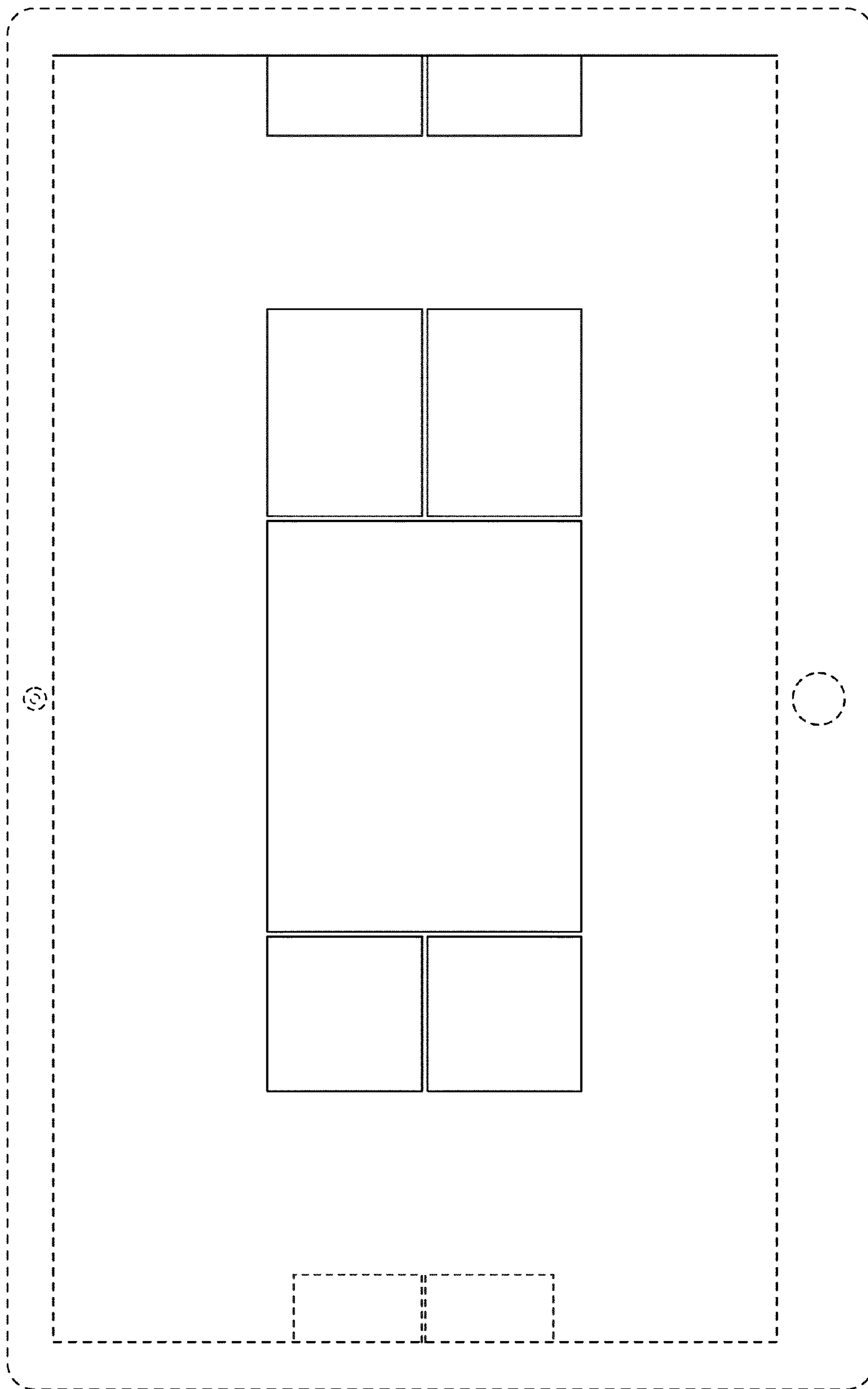

FIG. 1

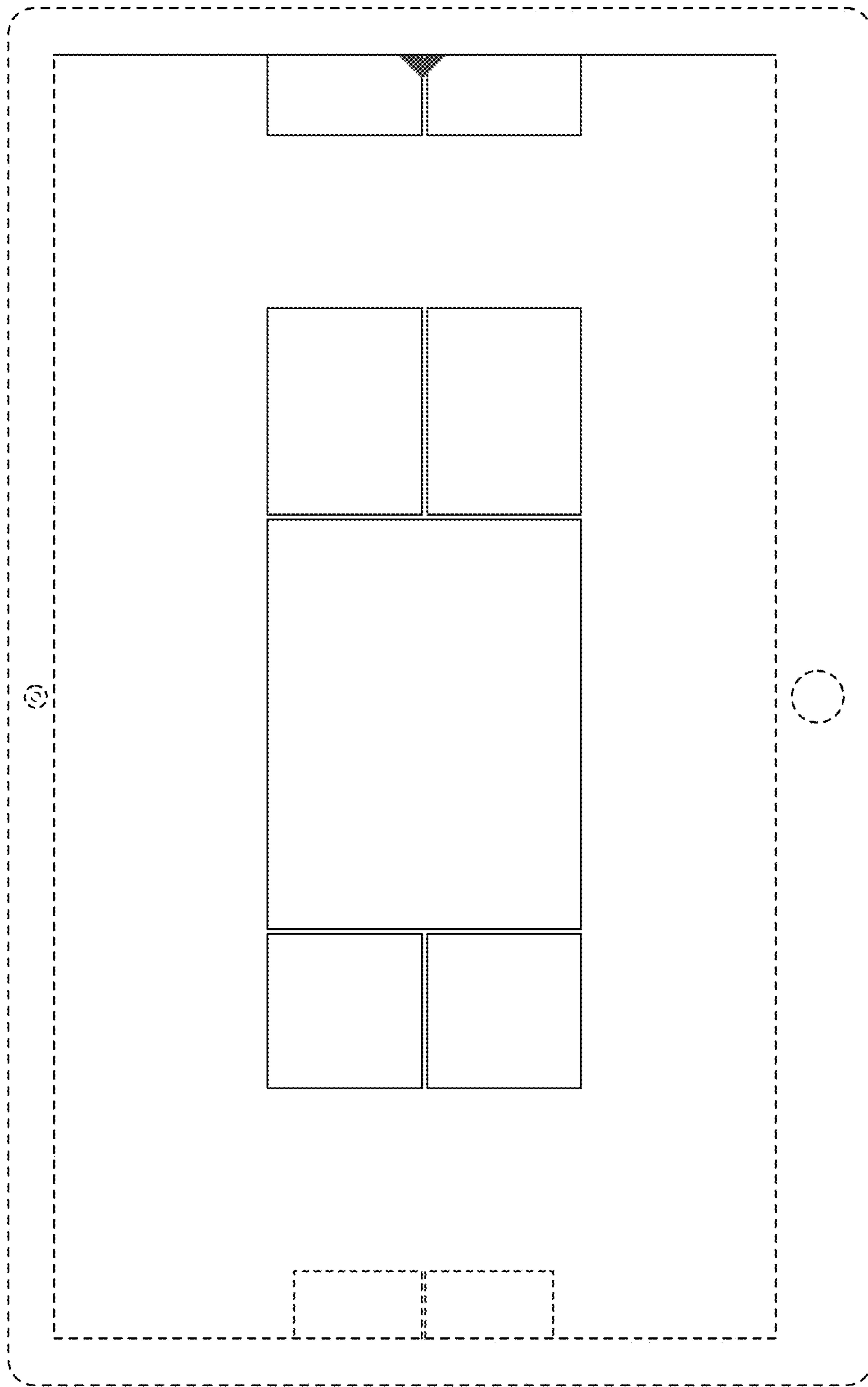

FIG. 2

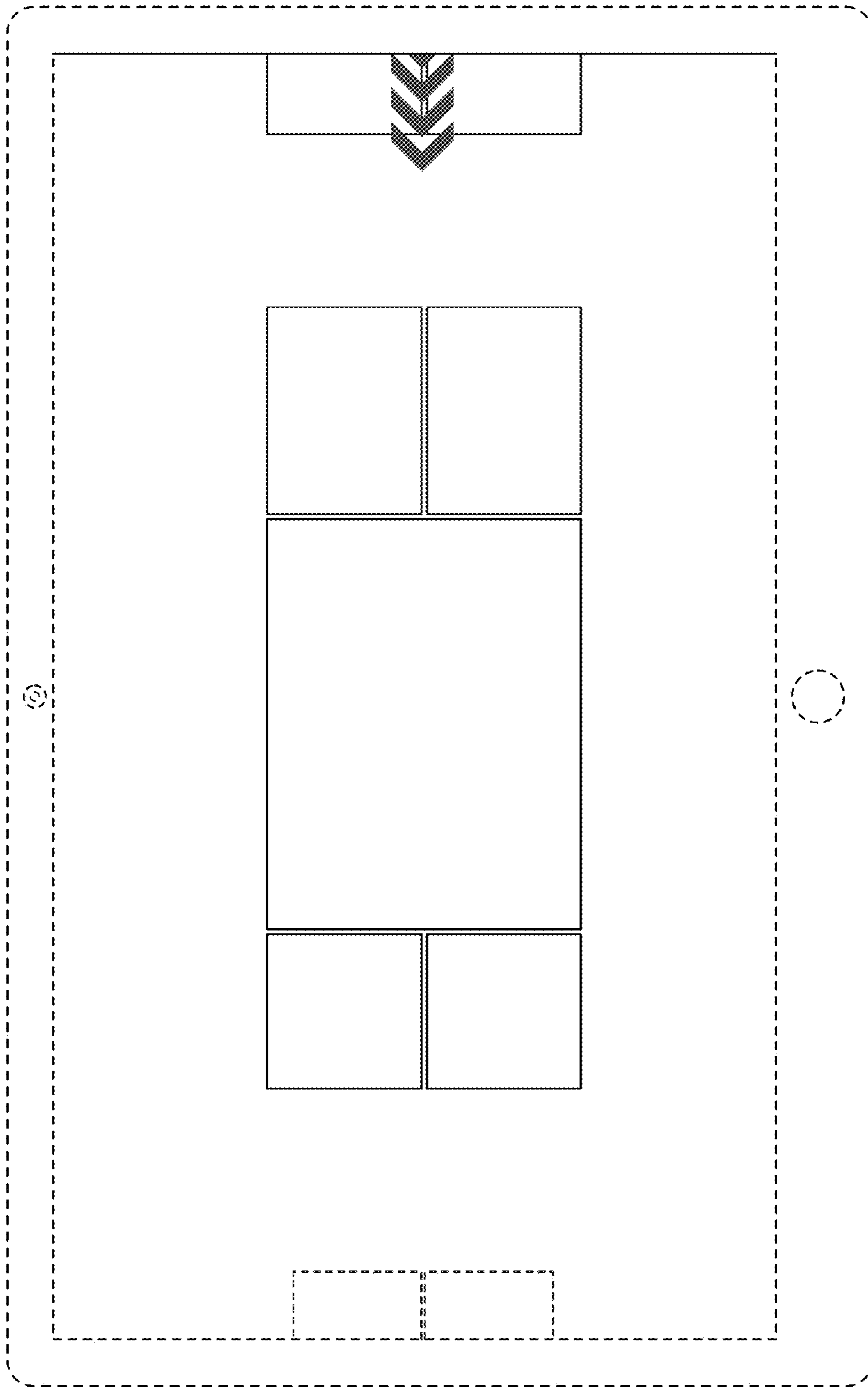

FIG. 3

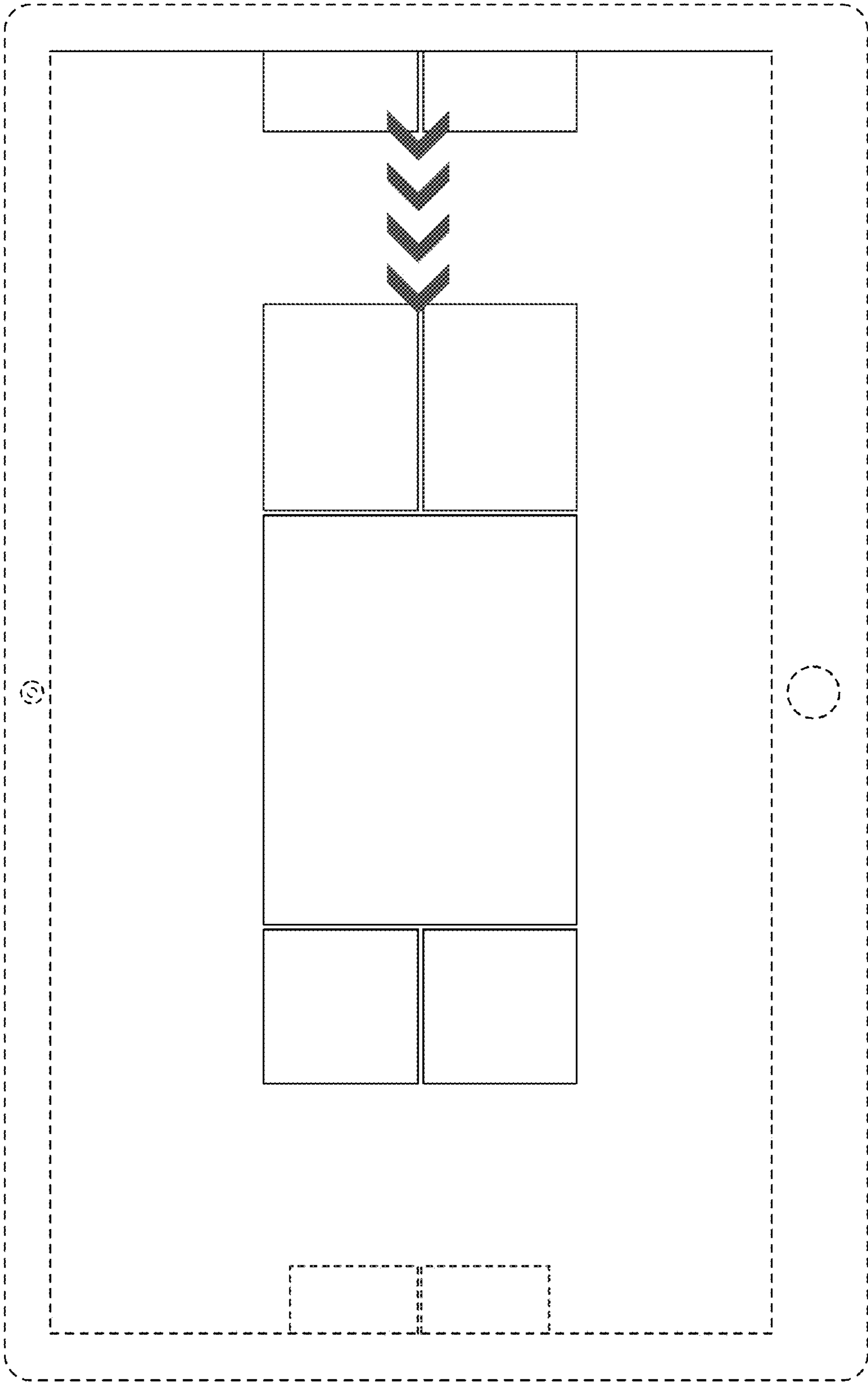

FIG. 4

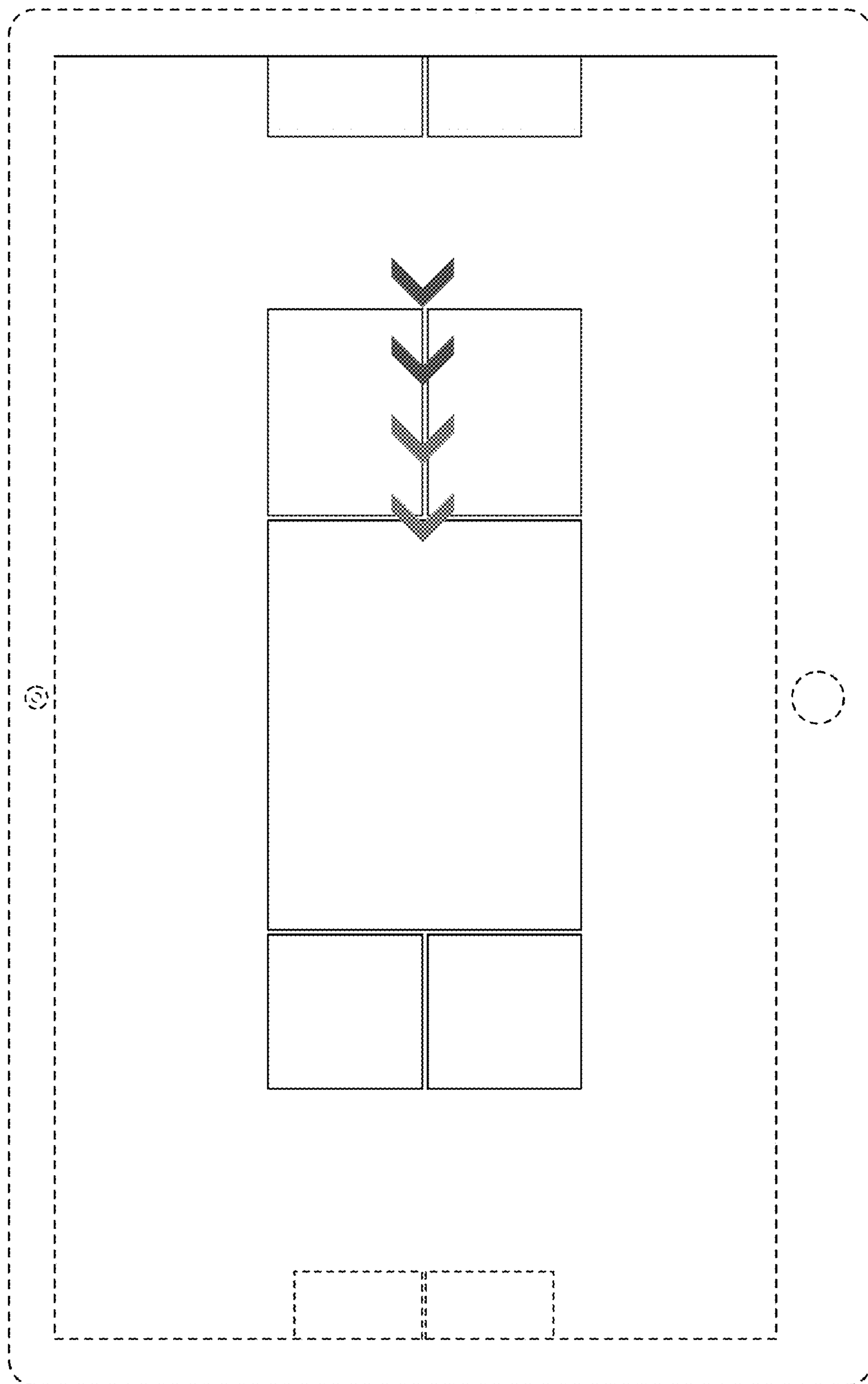

FIG. 5

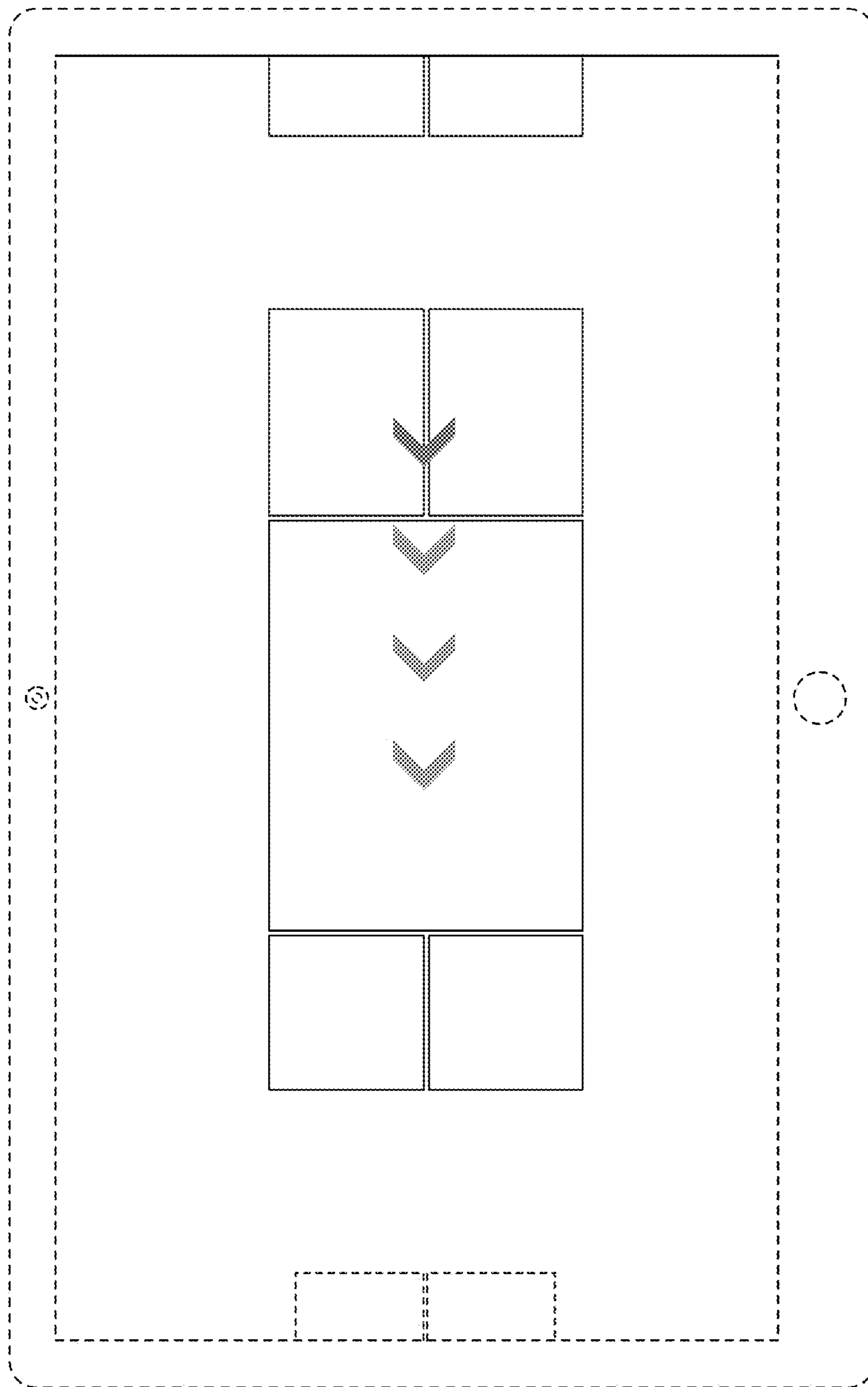

FIG. 6

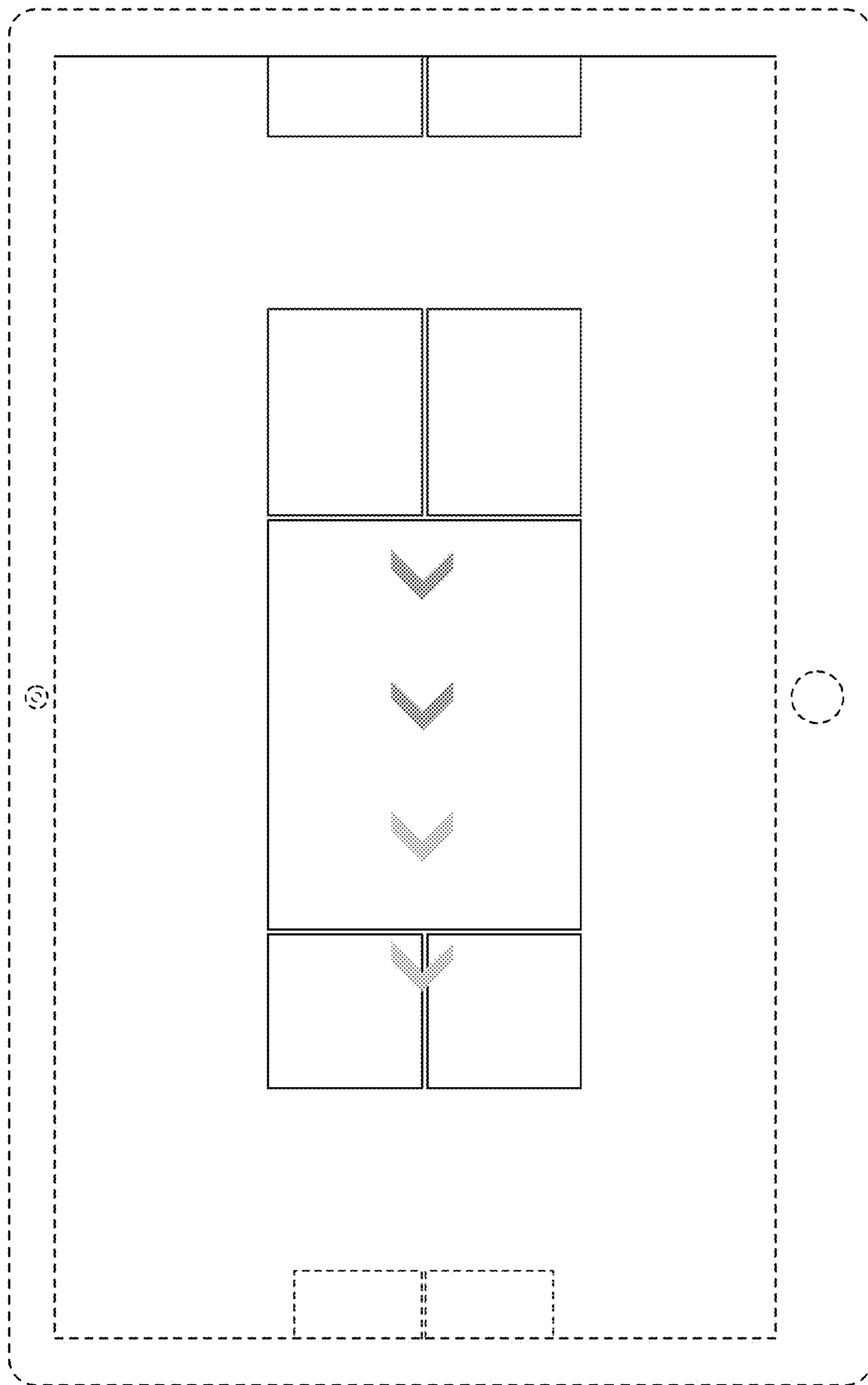

FIG. 7

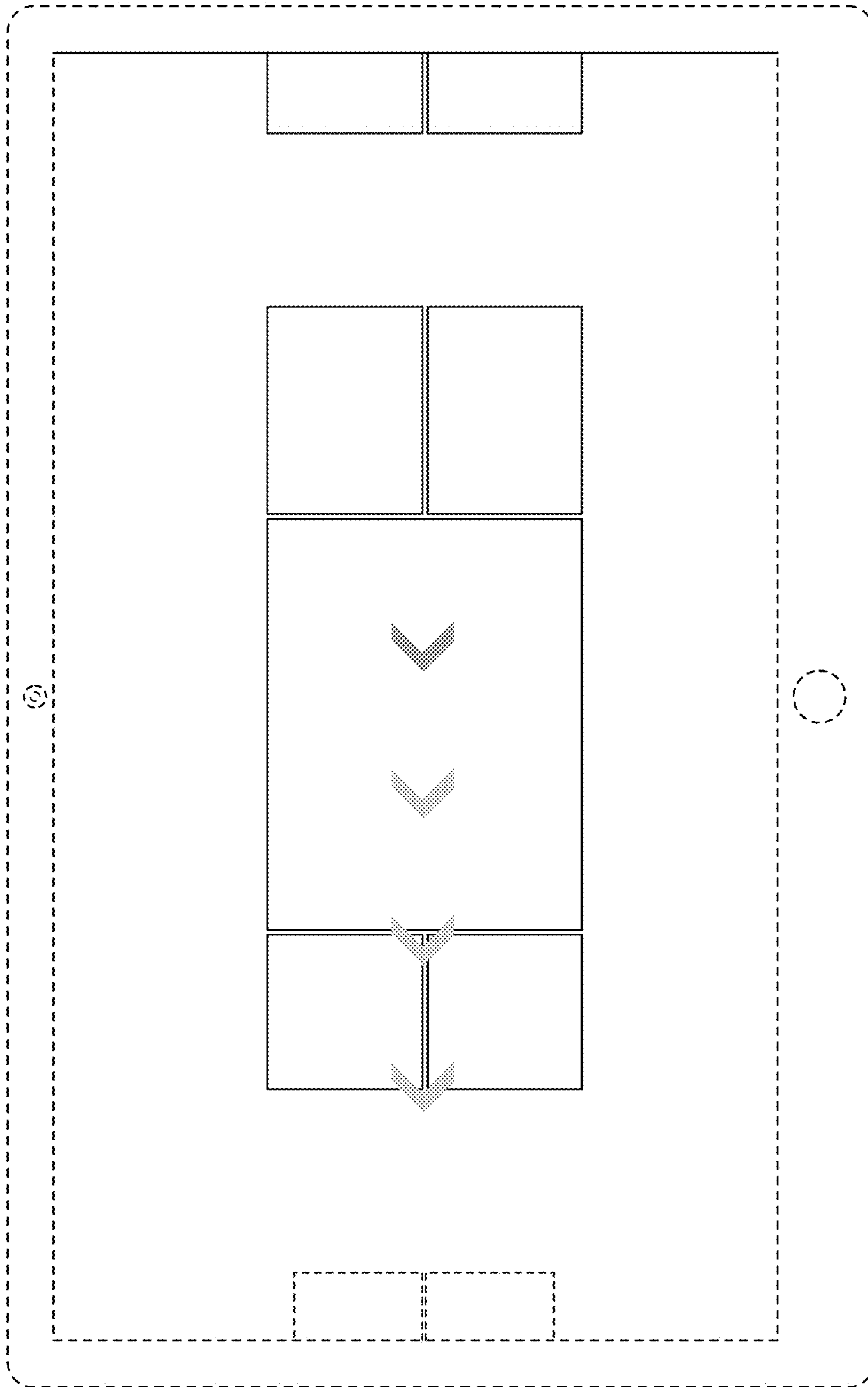

FIG. 8

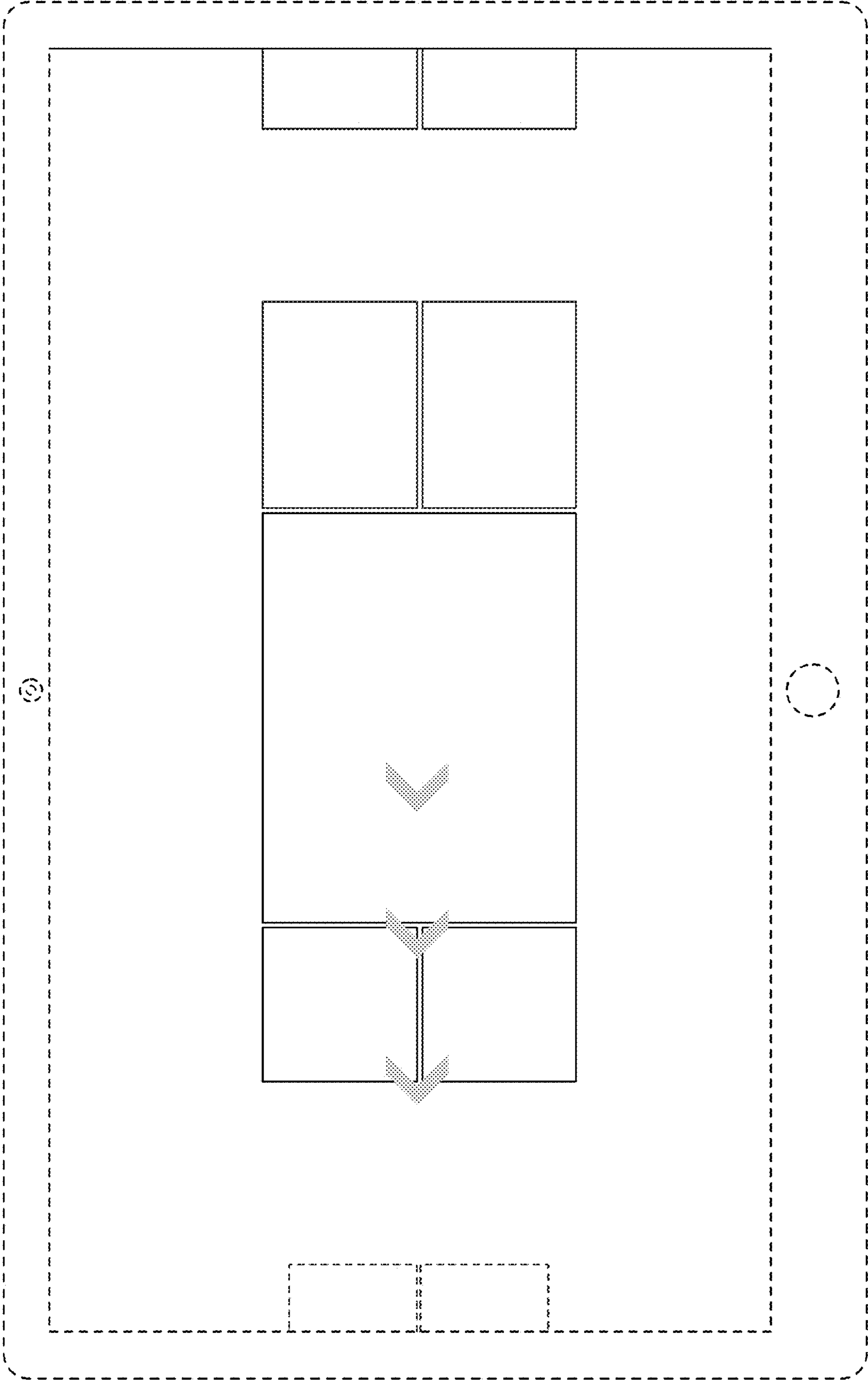

FIG. 9

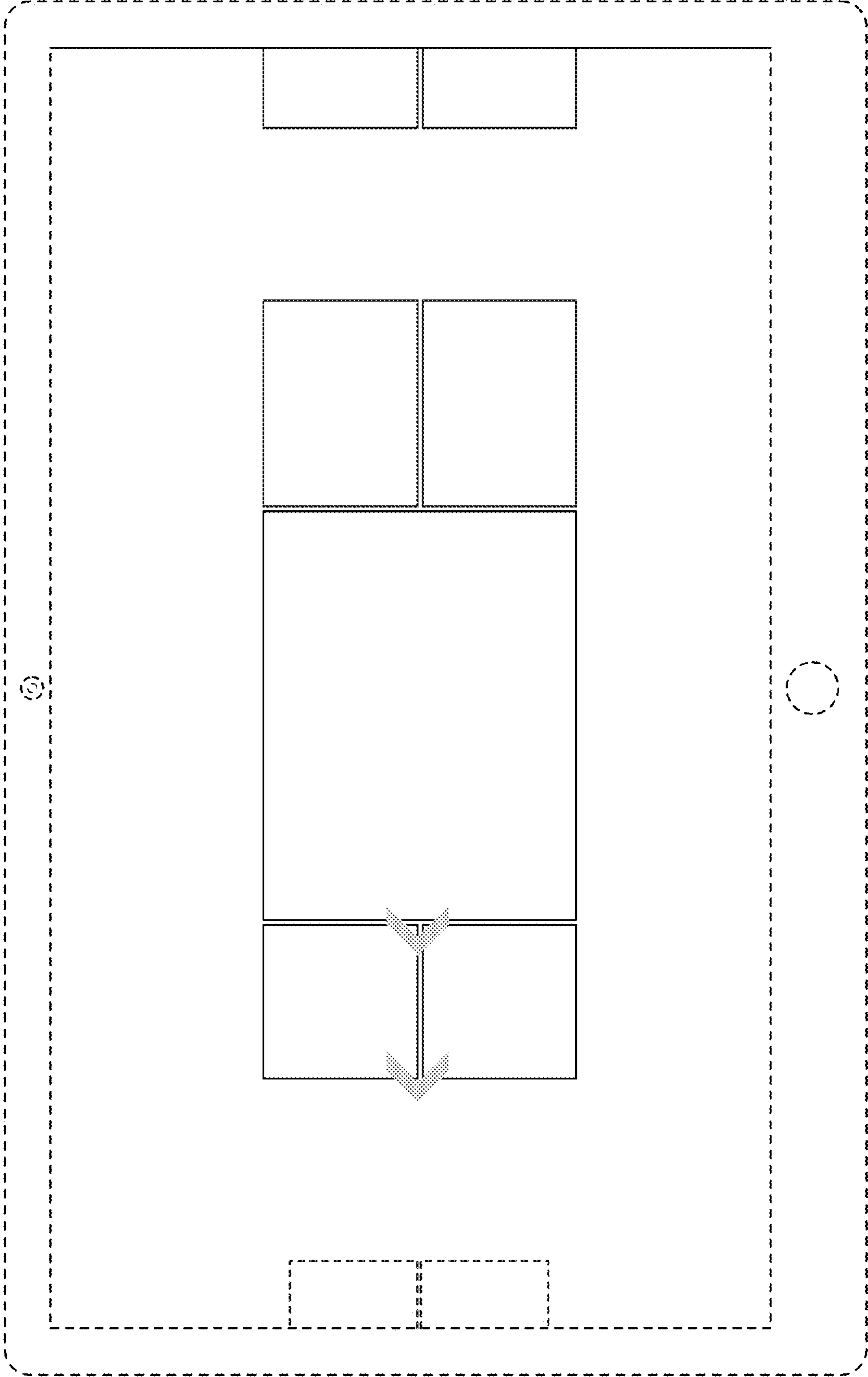

FIG. 10

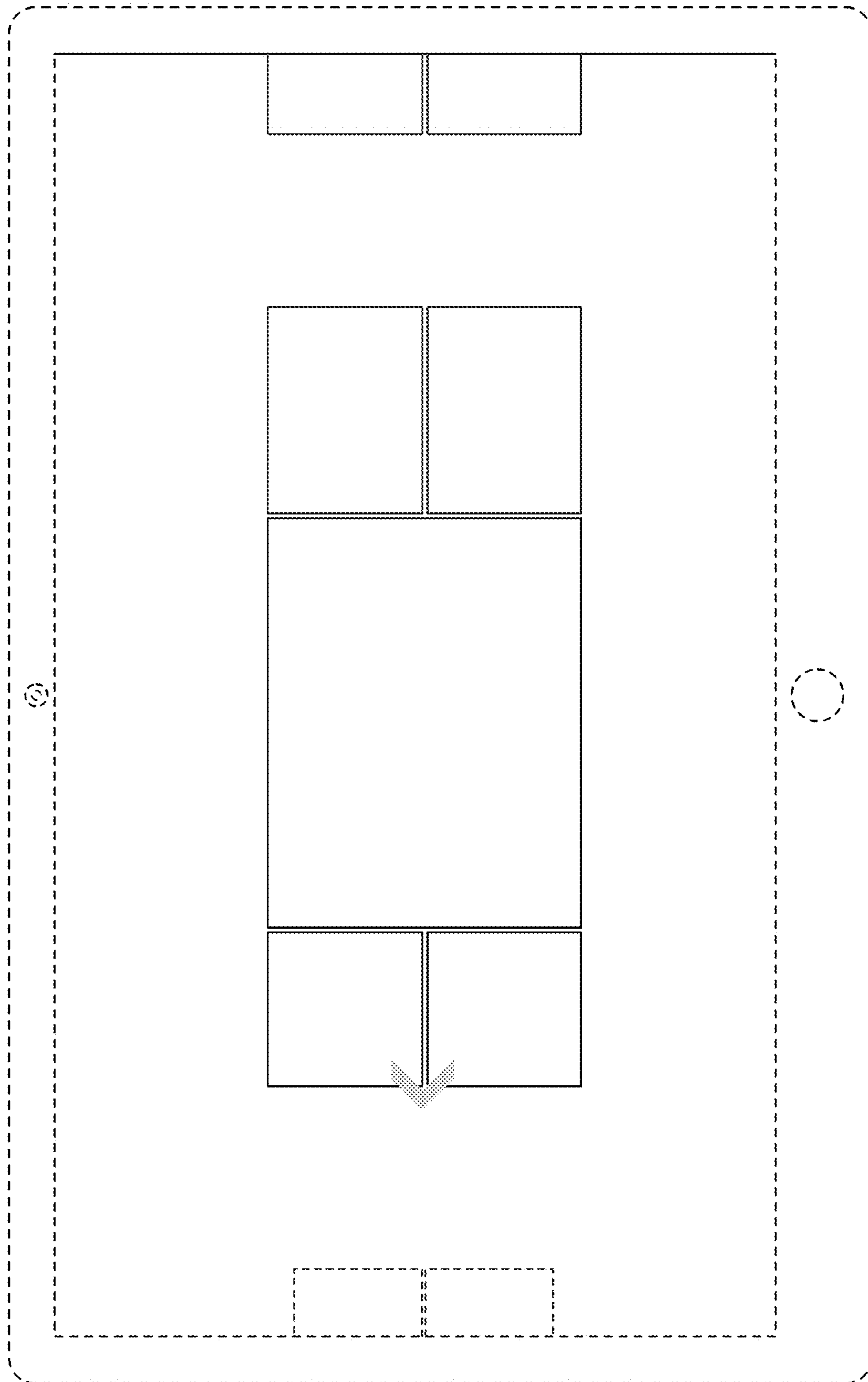

FIG. 11

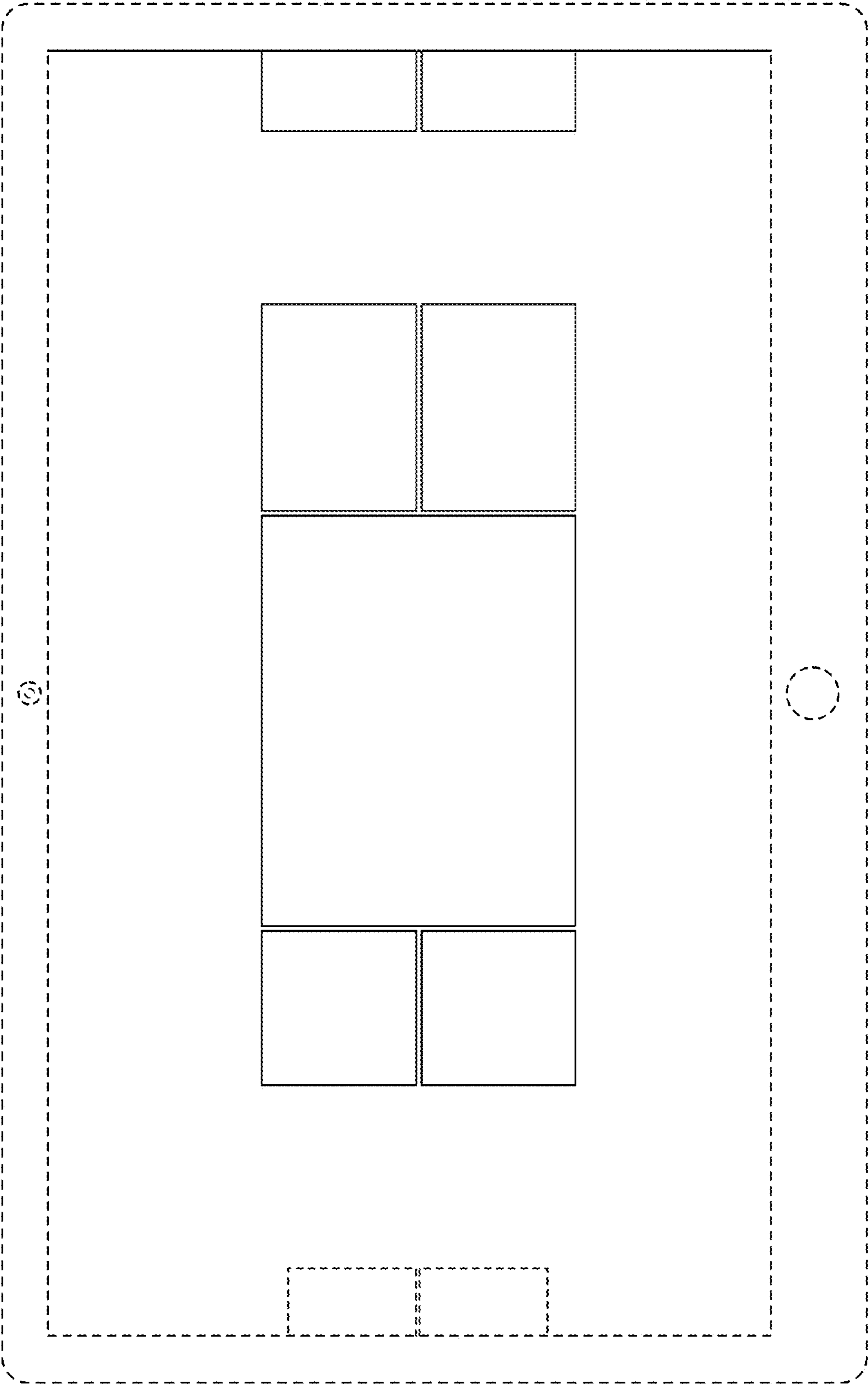

FIG. 12

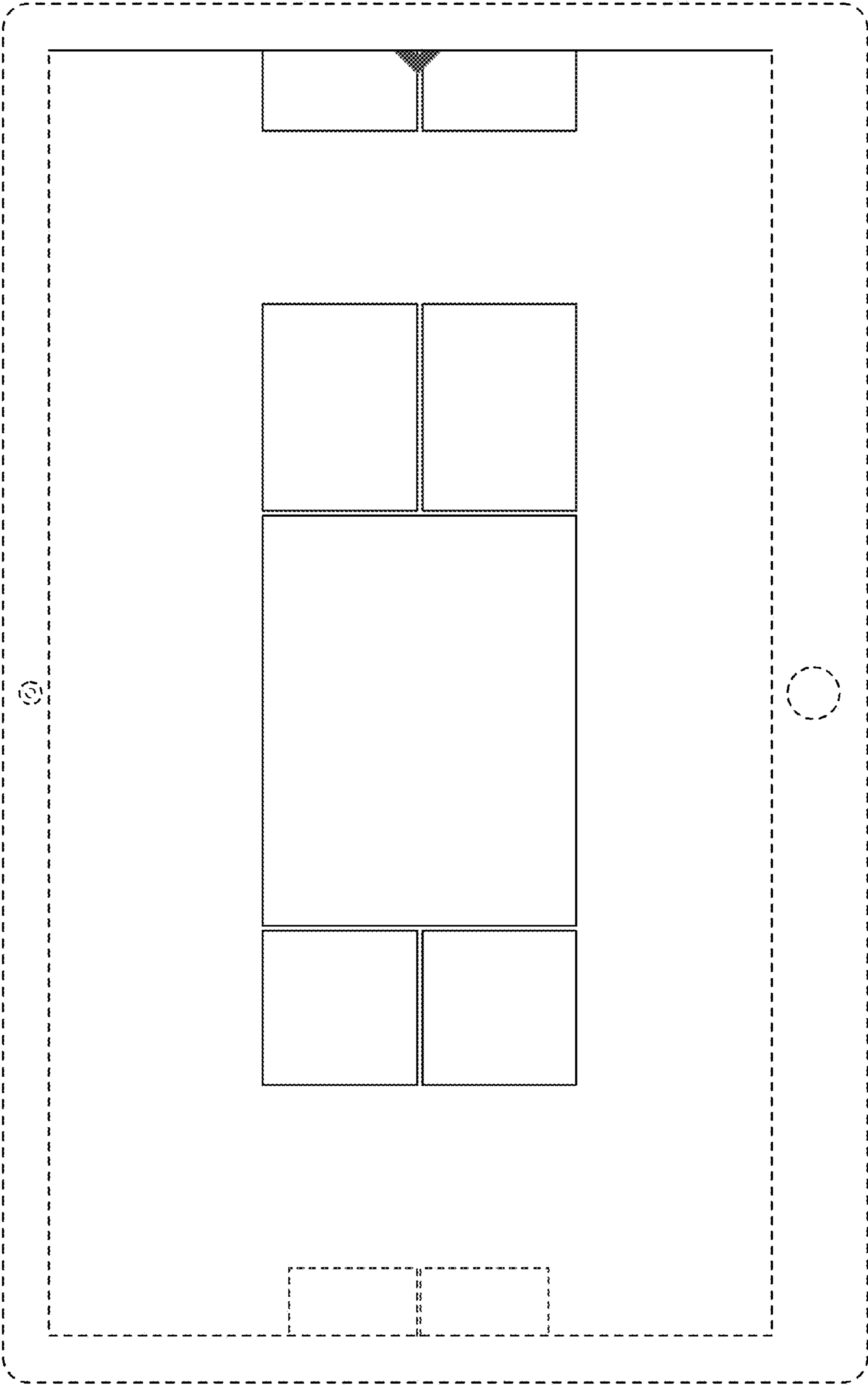

FIG. 13

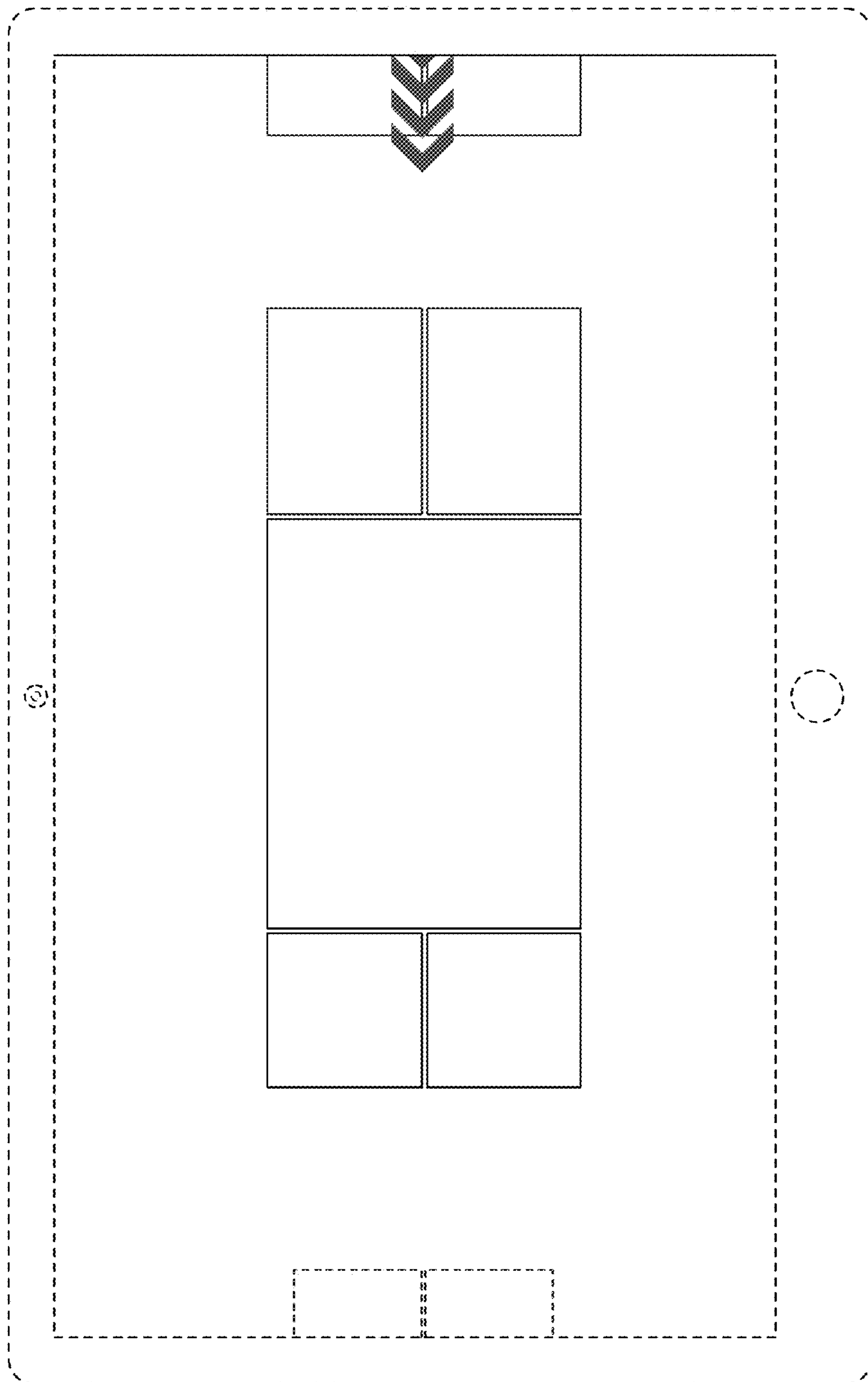

FIG. 14

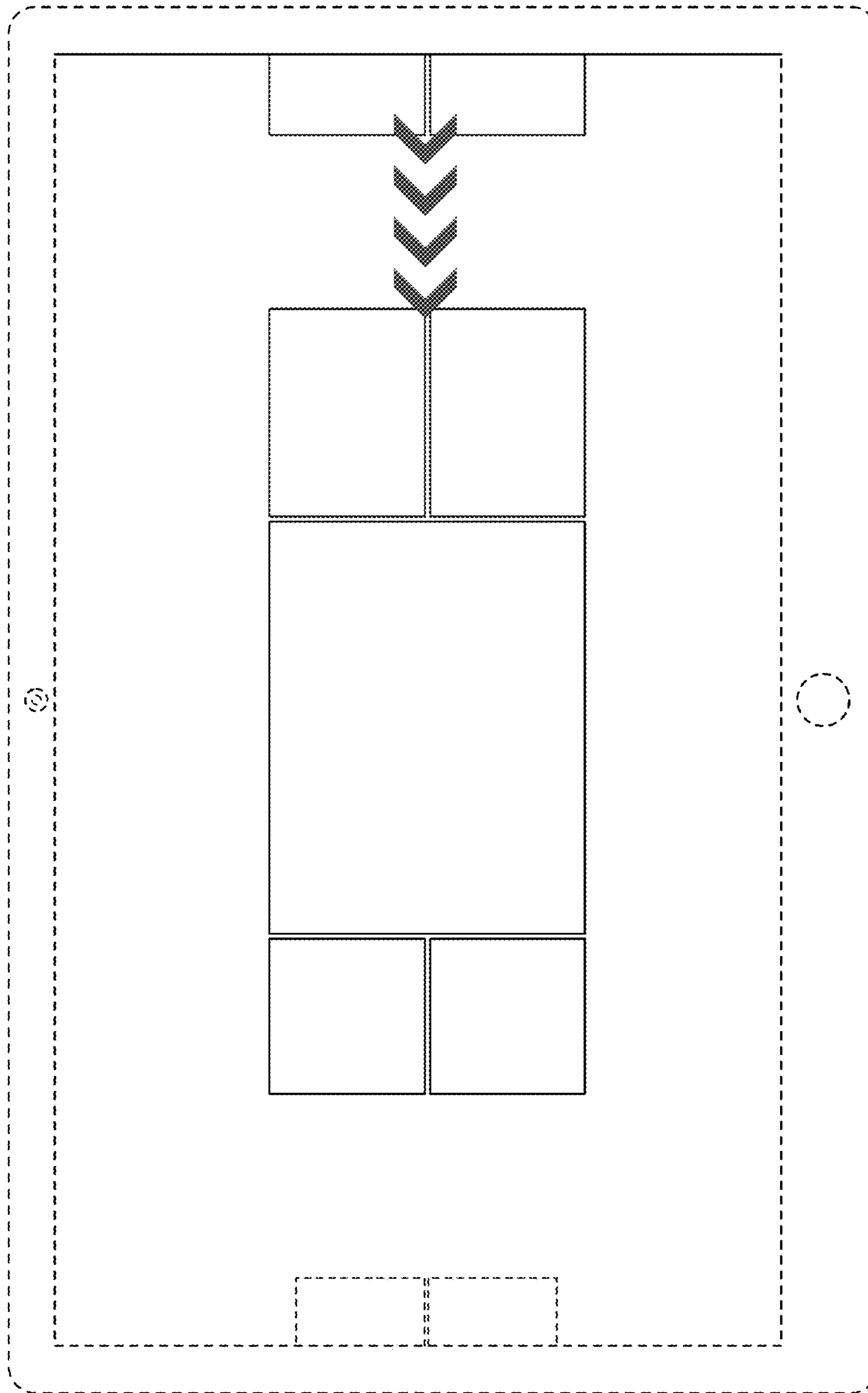

FIG. 15

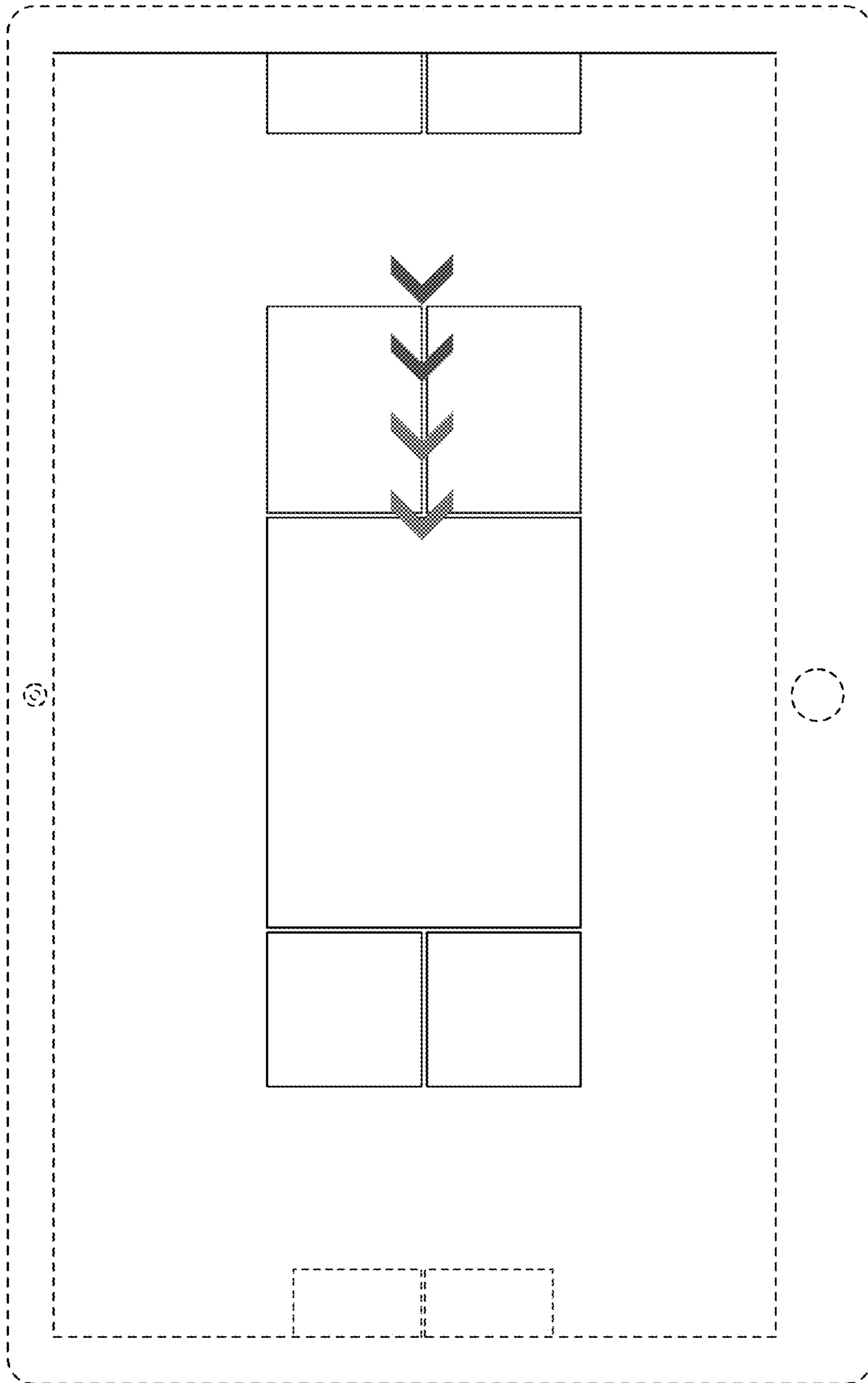

FIG. 16

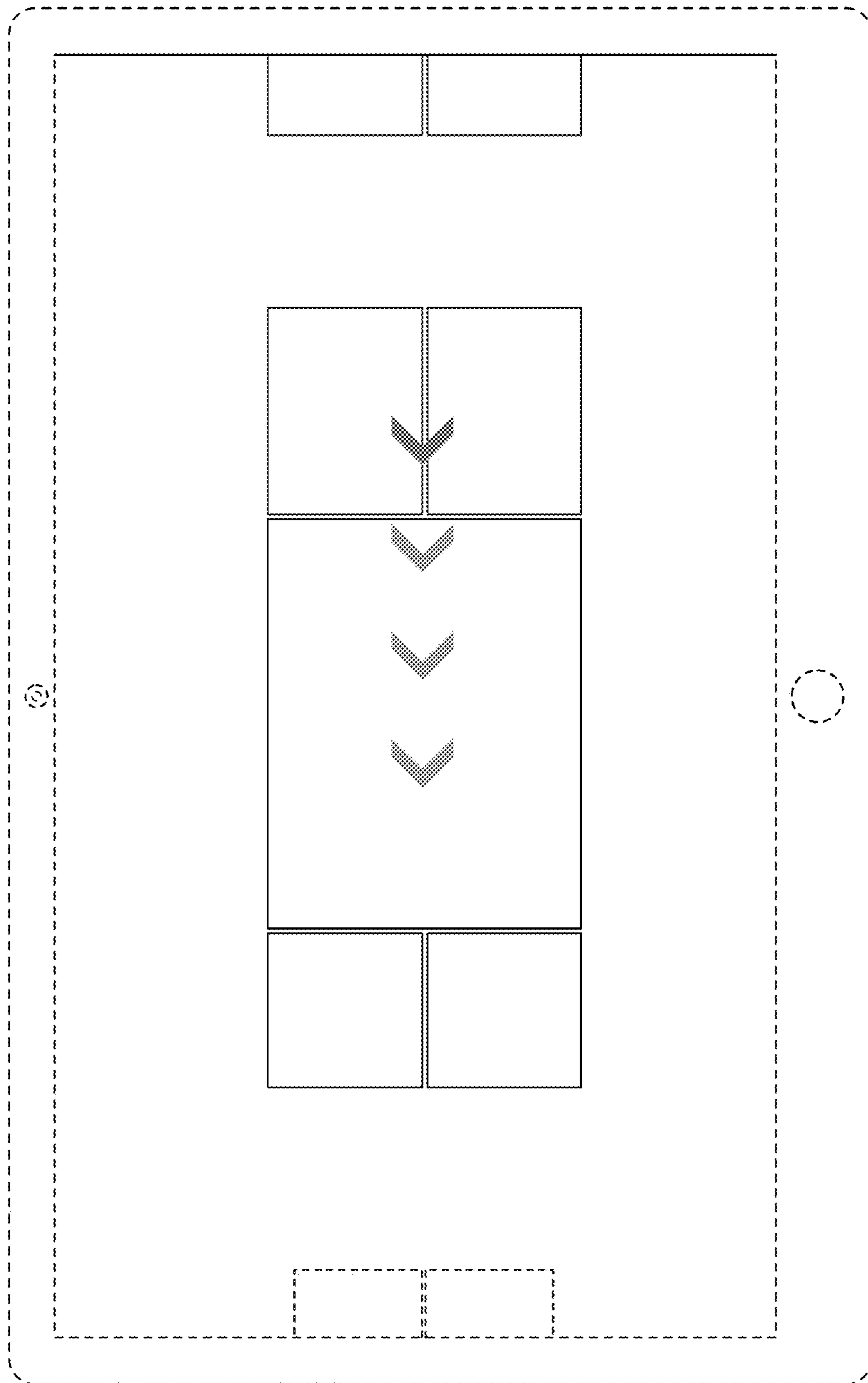

FIG. 17

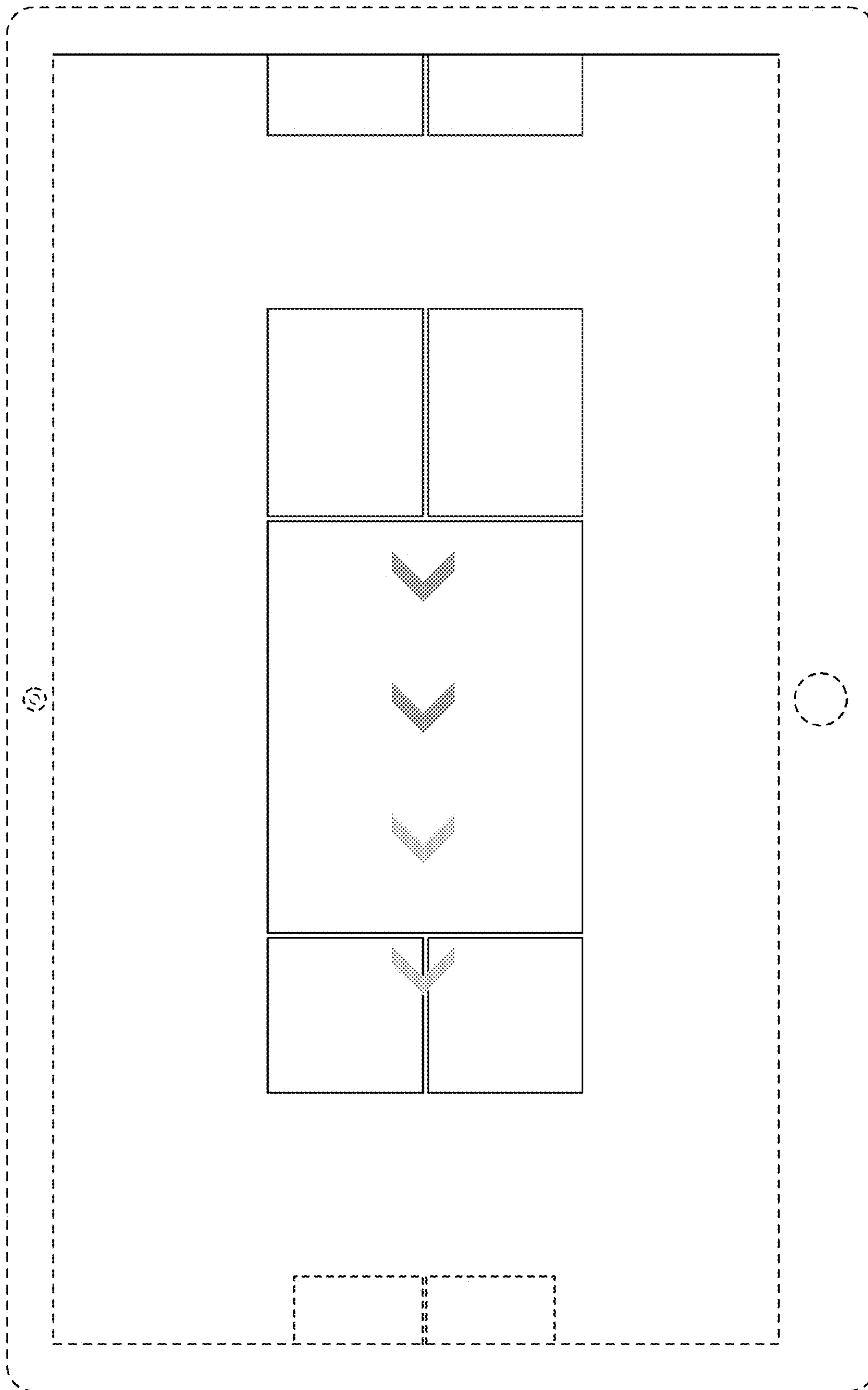

FIG. 18

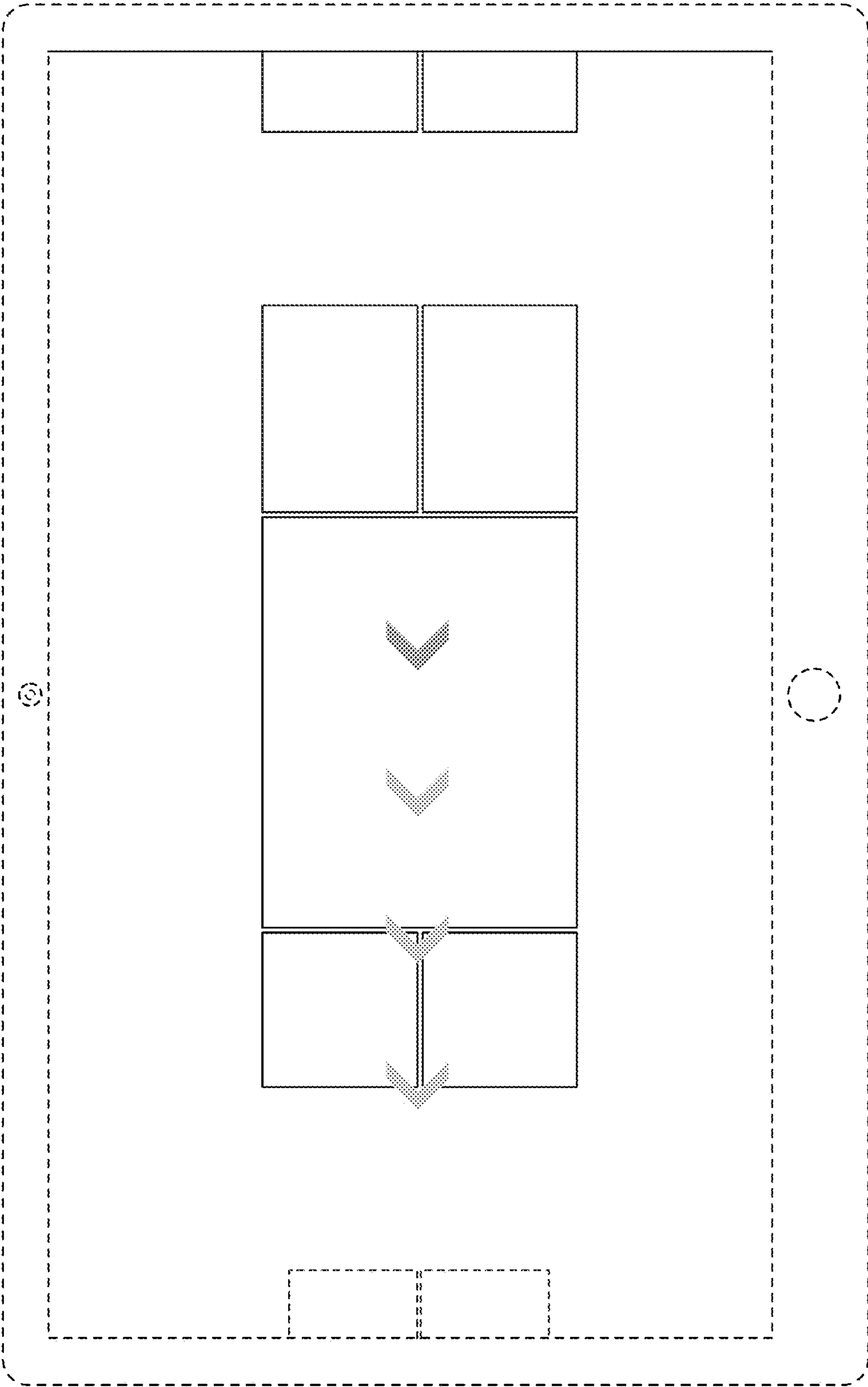

FIG. 19

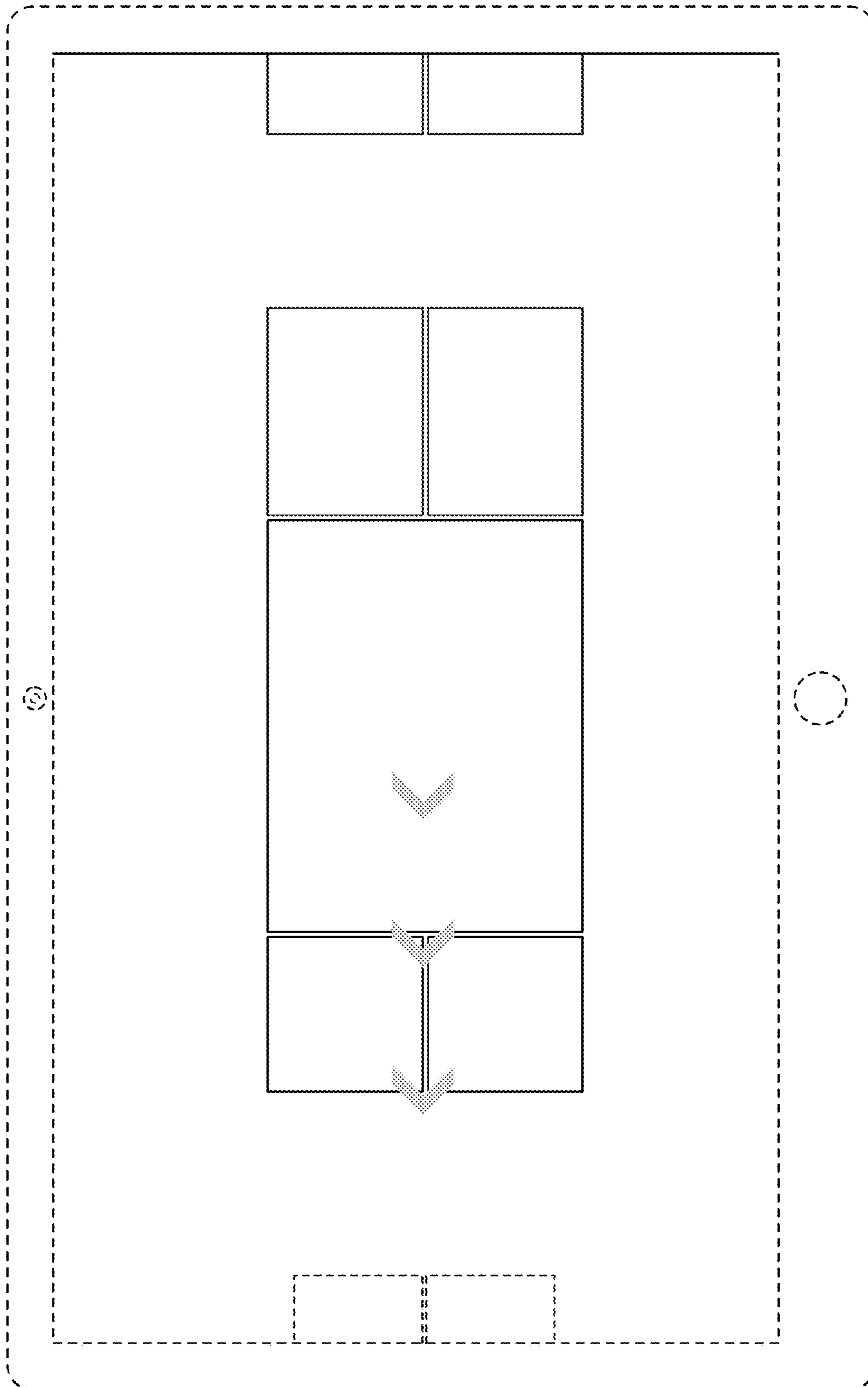

FIG. 20

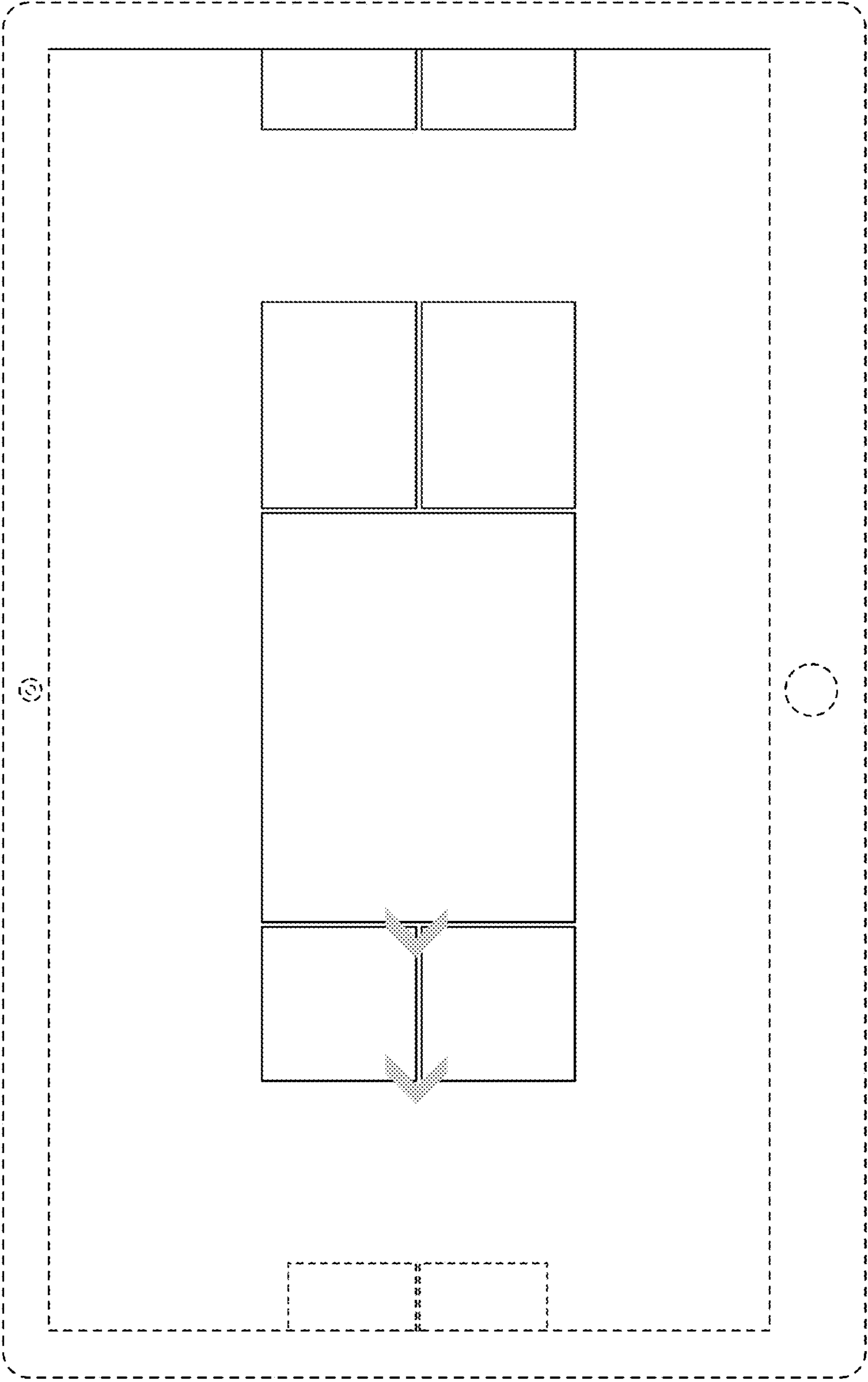

FIG. 21

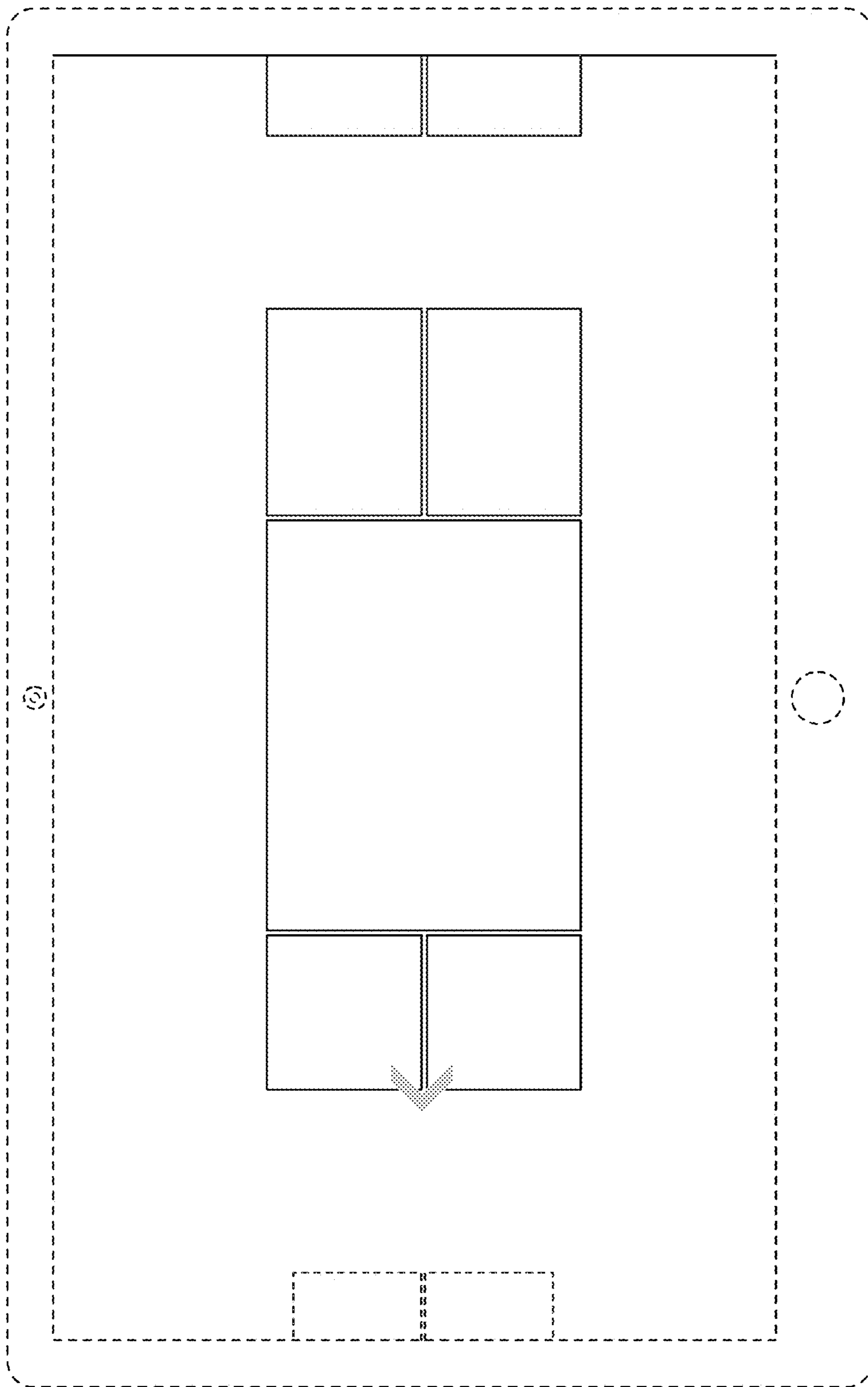

FIG. 22

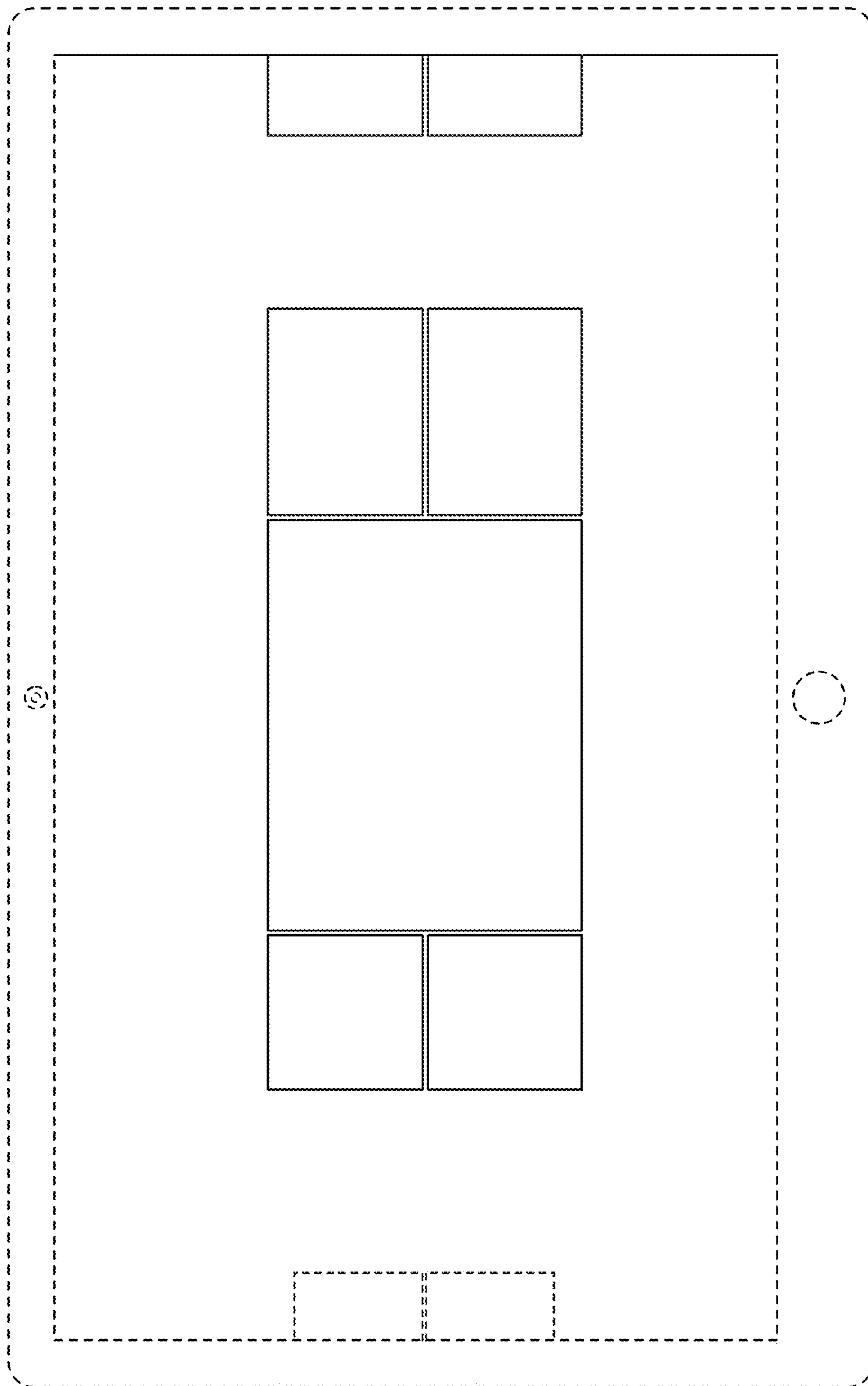

FIG. 23