



US00D686209S

(12) **United States Design Patent**
Sun et al.

(10) **Patent No.:** **US D686,209 S**
(45) **Date of Patent:** **** Jul. 16, 2013**

(54) **GAME CONTROLLER**

(75) Inventors: **Shengchyan Sun**, North Providence, RI (US); **Fred S. Galpern**, Providence, RI (US); **John E. O'Donnell**, Ft. Lauderdale, FL (US)

(73) Assignee: **inMusic Brands, Inc.**, Cumberland, RI (US)

(**) Term: **14 Years**

(21) Appl. No.: **29/417,570**

(22) Filed: **Apr. 5, 2012**

(51) **LOC (9) Cl.** **14-03**

(52) **U.S. Cl.**
USPC **D14/401**; D14/496

(58) **Field of Classification Search**
USPC D21/324-333; D14/341-346, 356, D14/432, 496, 207.3, 203.7, 507, 399-401; 273/148 B; 463/1, 29-47; 345/156-161, 345/168, 169, 172; 341/22, 23
See application file for complete search history.

(56) **References Cited**

U.S. PATENT DOCUMENTS

5,361,788	A *	11/1994	Cole et al.	134/64 R
5,661,641	A *	8/1997	Shindo	361/814
5,818,701	A *	10/1998	Shindo	361/814
5,956,625	A *	9/1999	Hansen et al.	455/575.4
D475,710	S *	6/2003	Sheehan et al.	D14/401
D500,319	S *	12/2004	Wada	D14/401
D554,149	S *	10/2007	Kim	D14/496
D575,799	S *	8/2008	Zhang et al.	D14/496
D581,944	S *	12/2008	Zhang et al.	D14/496
D664,601	S *	7/2012	Sogabe	D21/329

* cited by examiner

Primary Examiner — Prabhakar Deshmukh

(74) *Attorney, Agent, or Firm* — Finnegan, Henderson, Farabow, Garrett and Dunner, LLP

(57) **CLAIM**

The ornamental design for a game controller, as shown and described.

DESCRIPTION

FIG. 1 is a top, front, right perspective view of a game controller showing our new design with the dock oriented in a portrait view;
FIG. 2 is a front elevation view thereof;
FIG. 3 is a rear elevation view thereof
FIG. 4 is a top view thereof;
FIG. 5 is a bottom view thereof;
FIG. 6 is a right side elevation view thereof;
FIG. 7 is a left side elevation view thereof;
FIG. 8 is a top, front, right perspective view of a game controller showing our new design with the dock oriented in a landscape view;
FIG. 9 is a front elevation view thereof;
FIG. 10 is a rear elevation view thereof
FIG. 11 is a top view thereof;
FIG. 12 is a bottom view thereof;
FIG. 13 is a right side elevation view thereof; and,
FIG. 14 is a left side elevation view thereof.
The structures depicted in broken lines in the figures are shown for illustrative purposes only and form no part of the design.

1 Claim, 14 Drawing Sheets

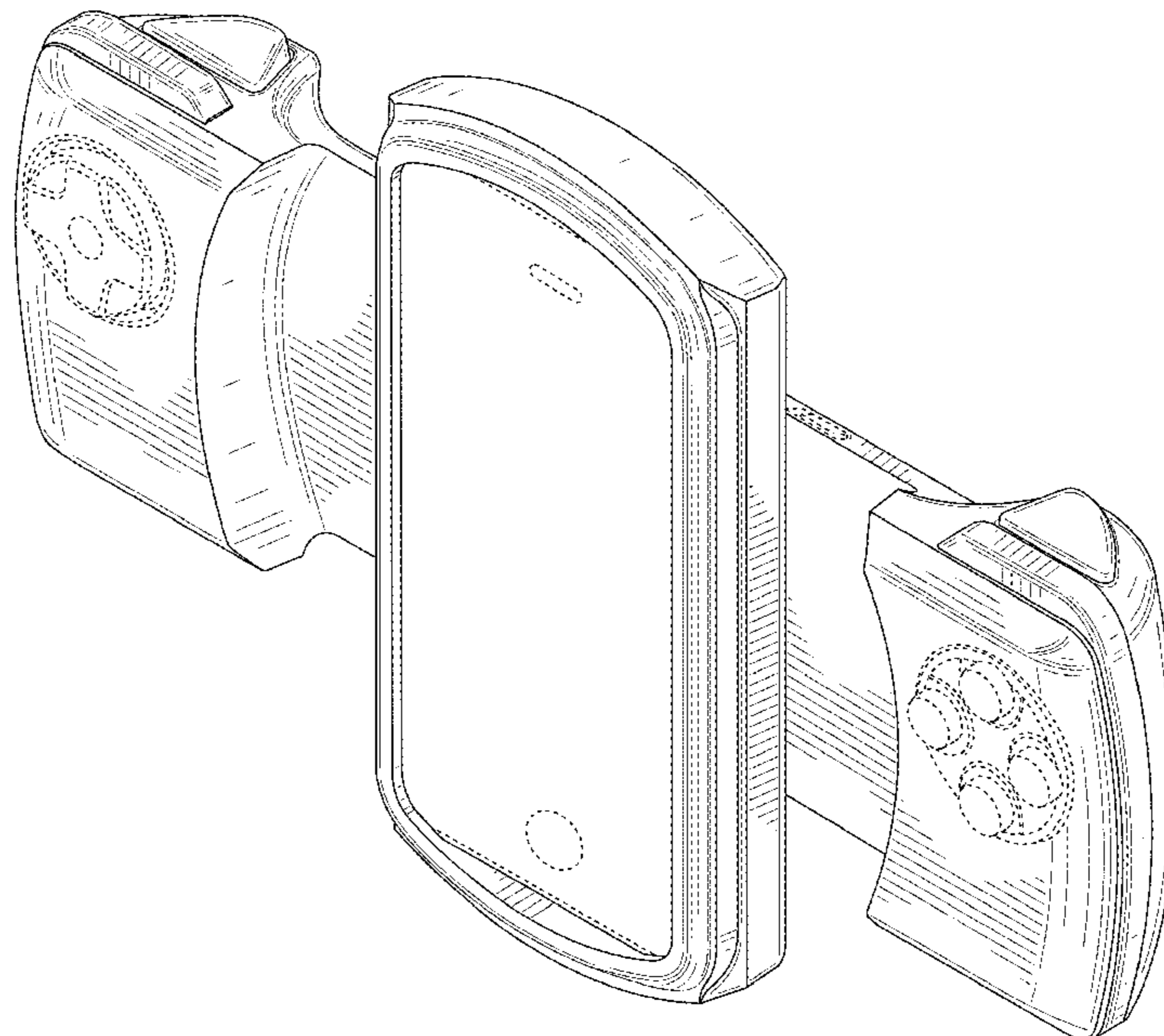

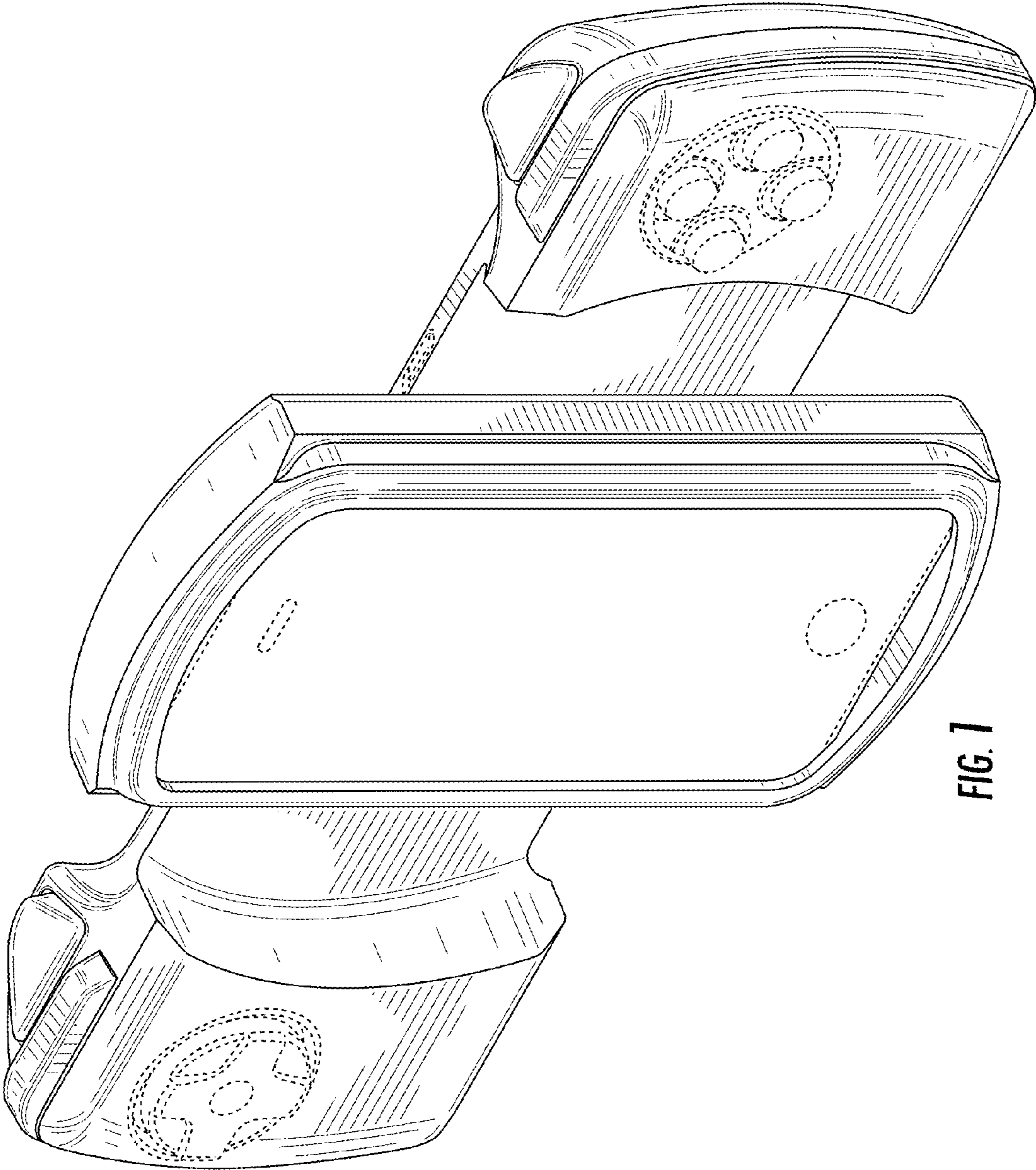

FIG. 1

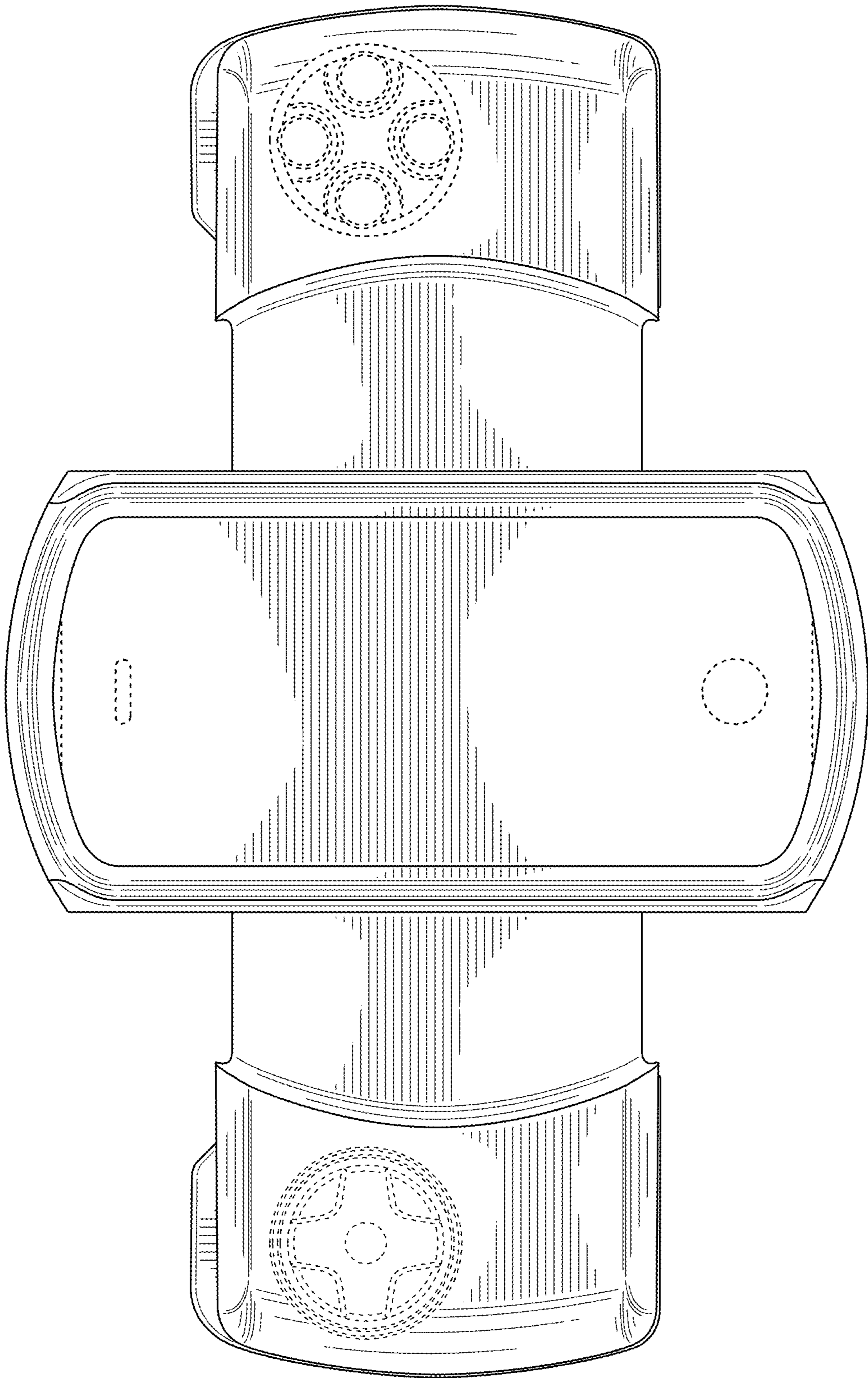

FIG. 2

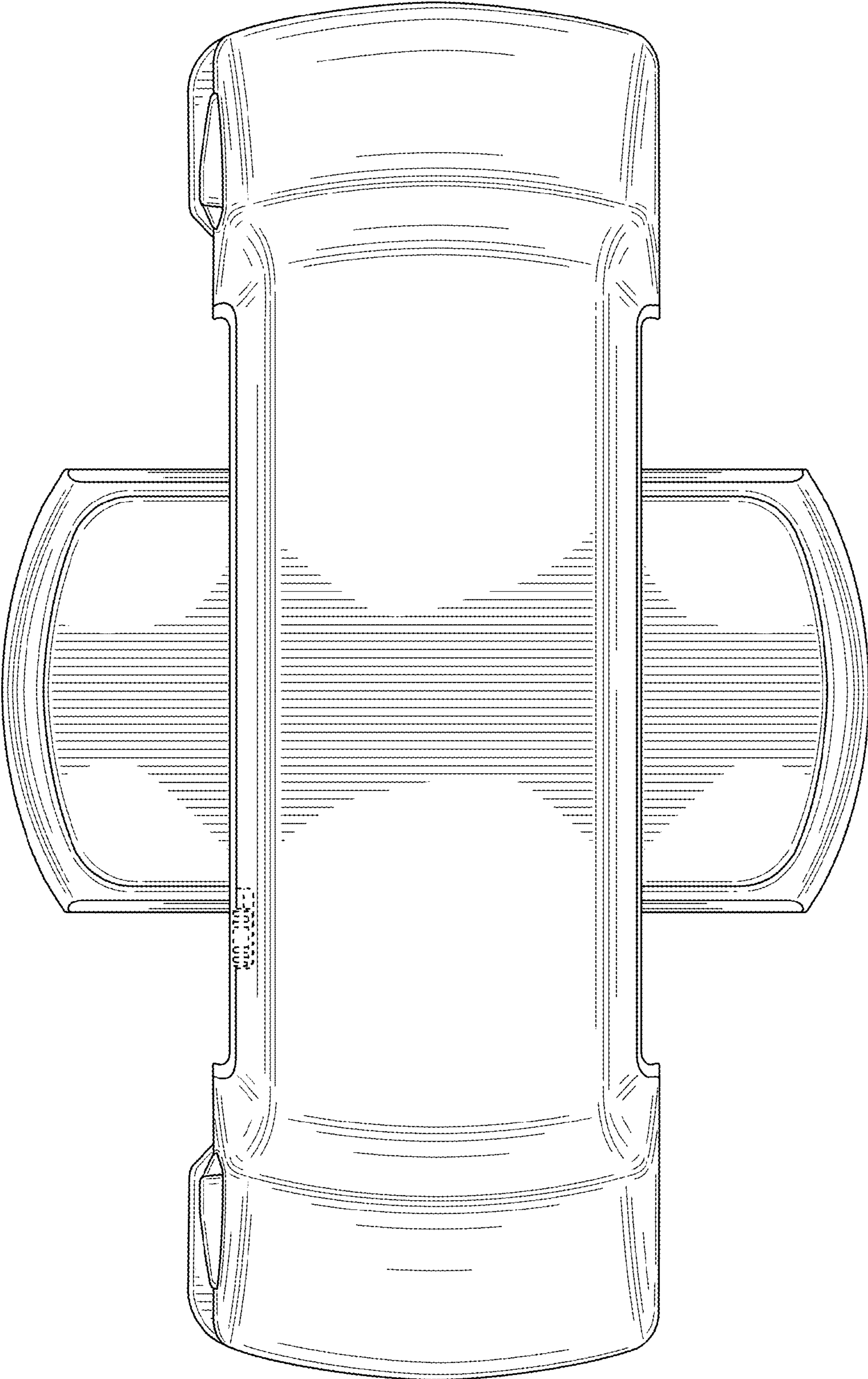

FIG. 3

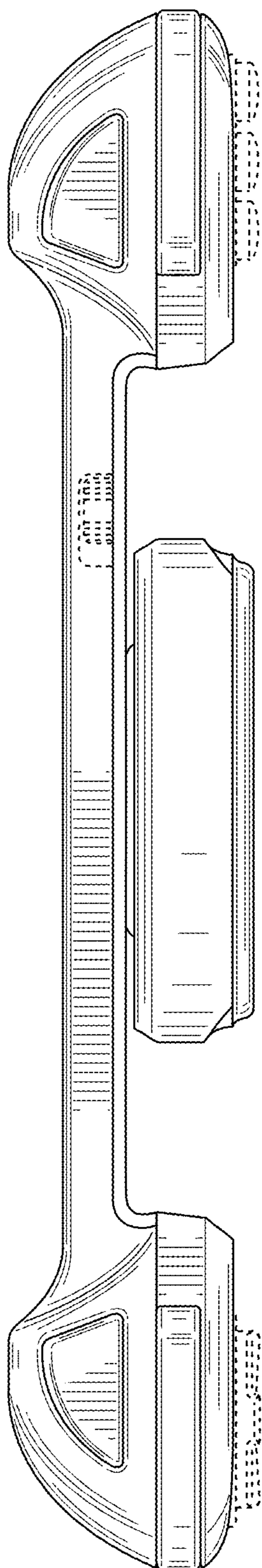

FIG. 4

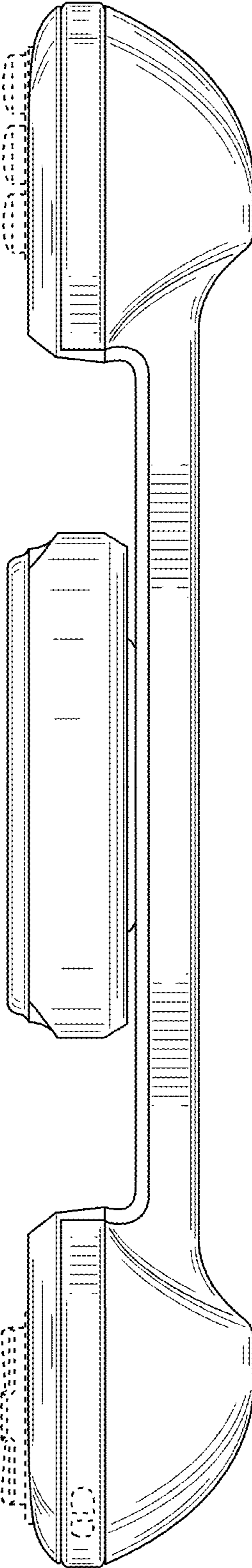

FIG. 5

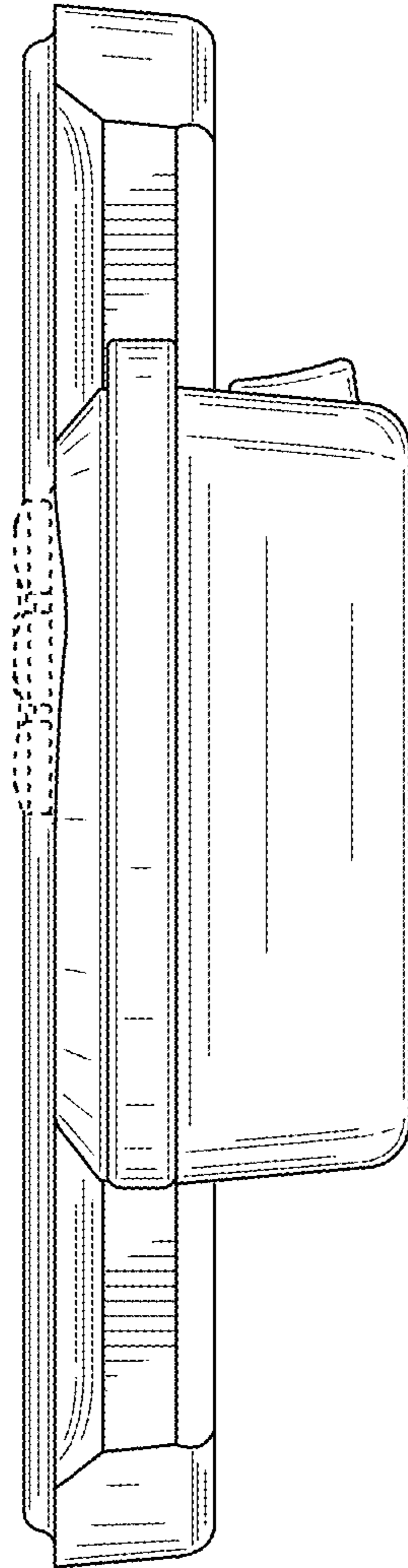

FIG. 6

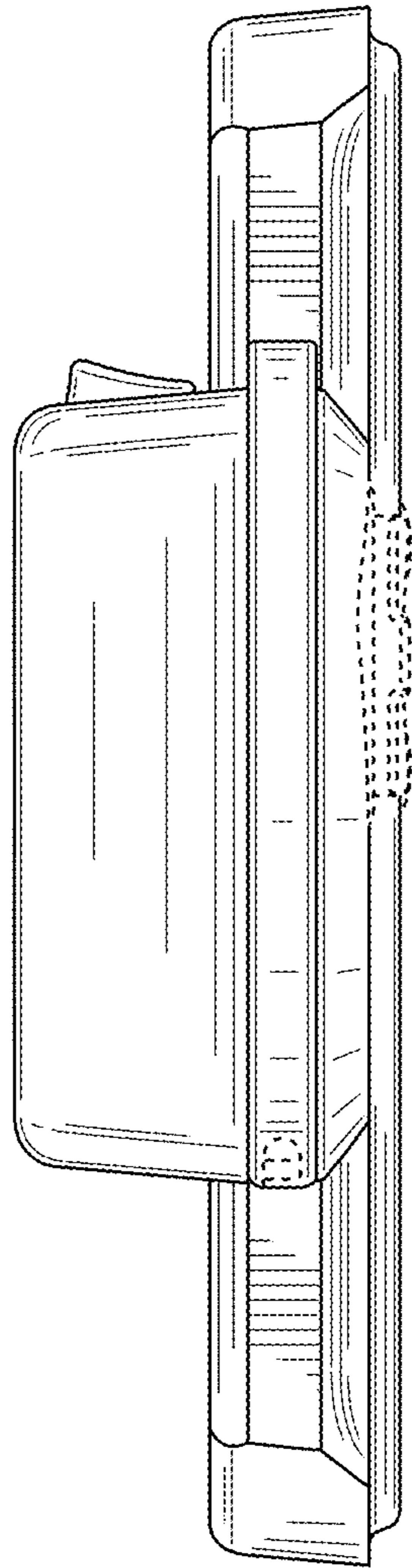

FIG. 7

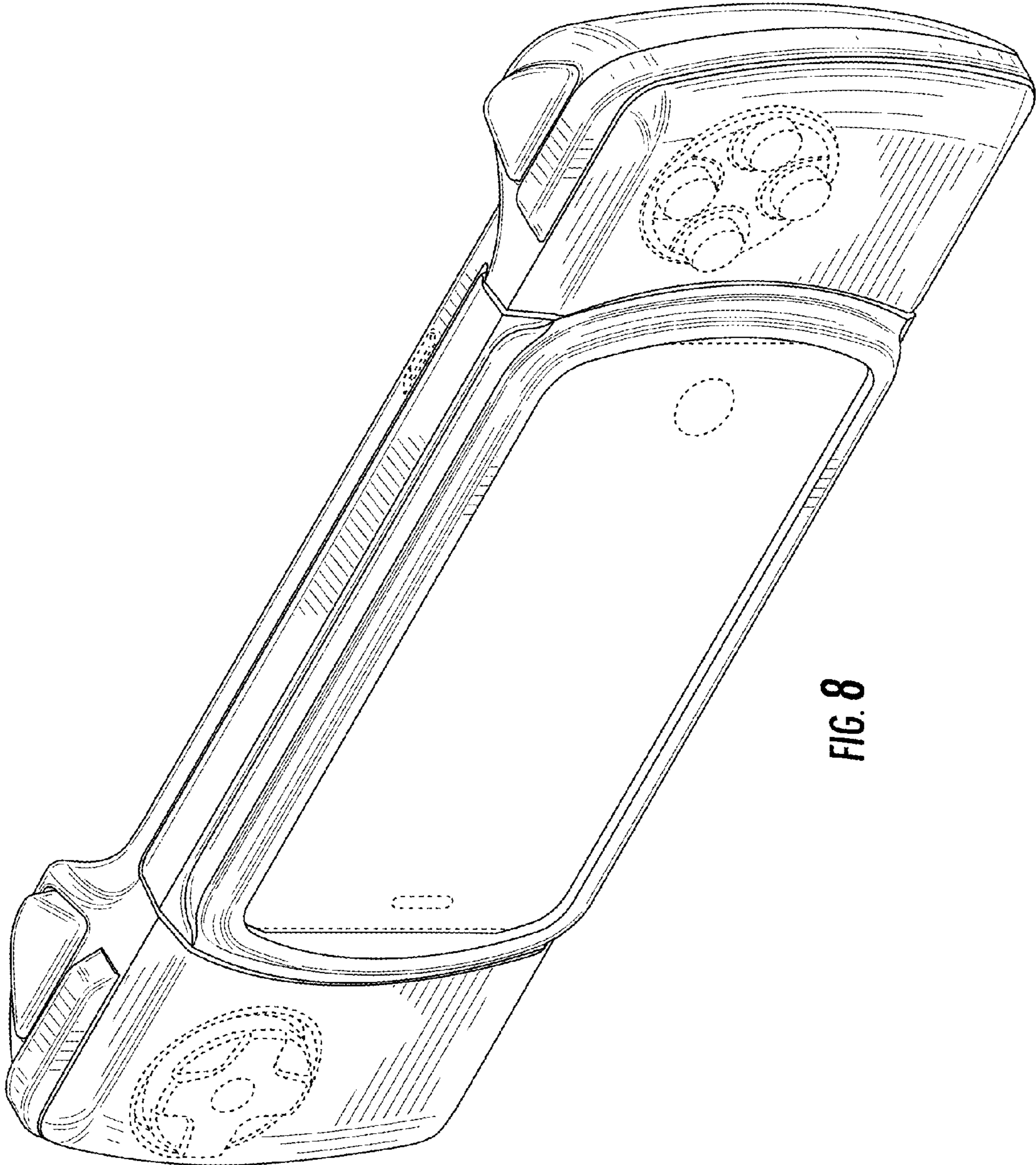

FIG. 8

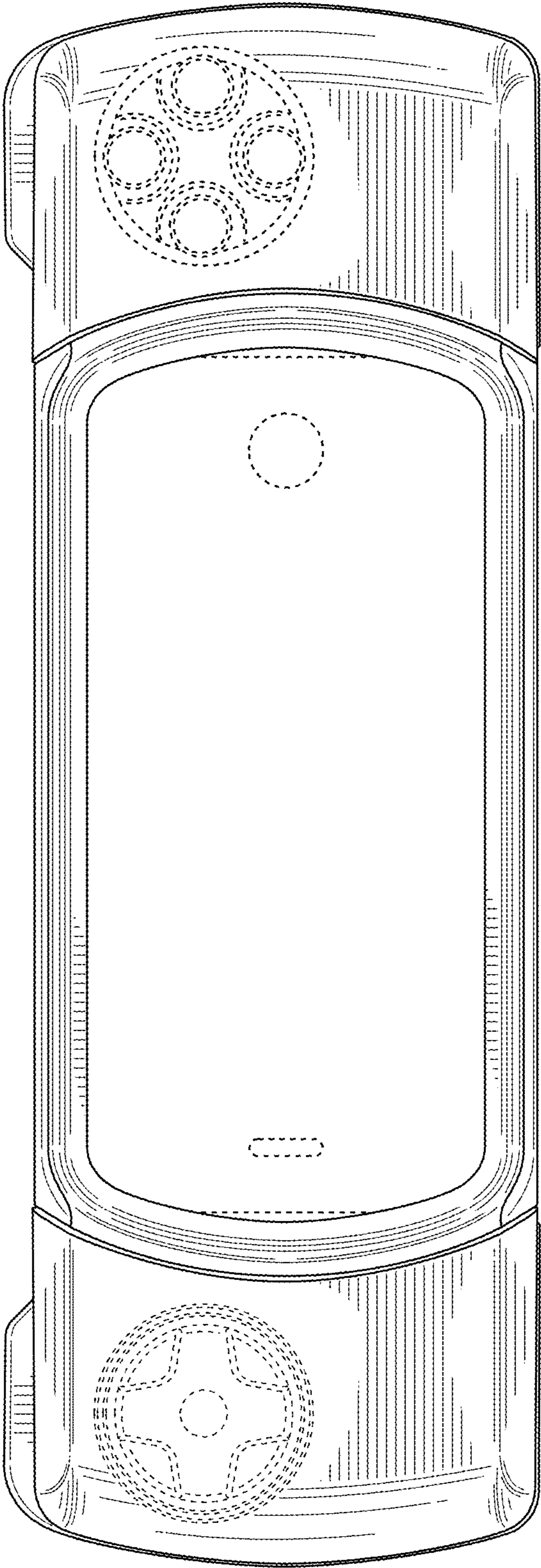

FIG. 9

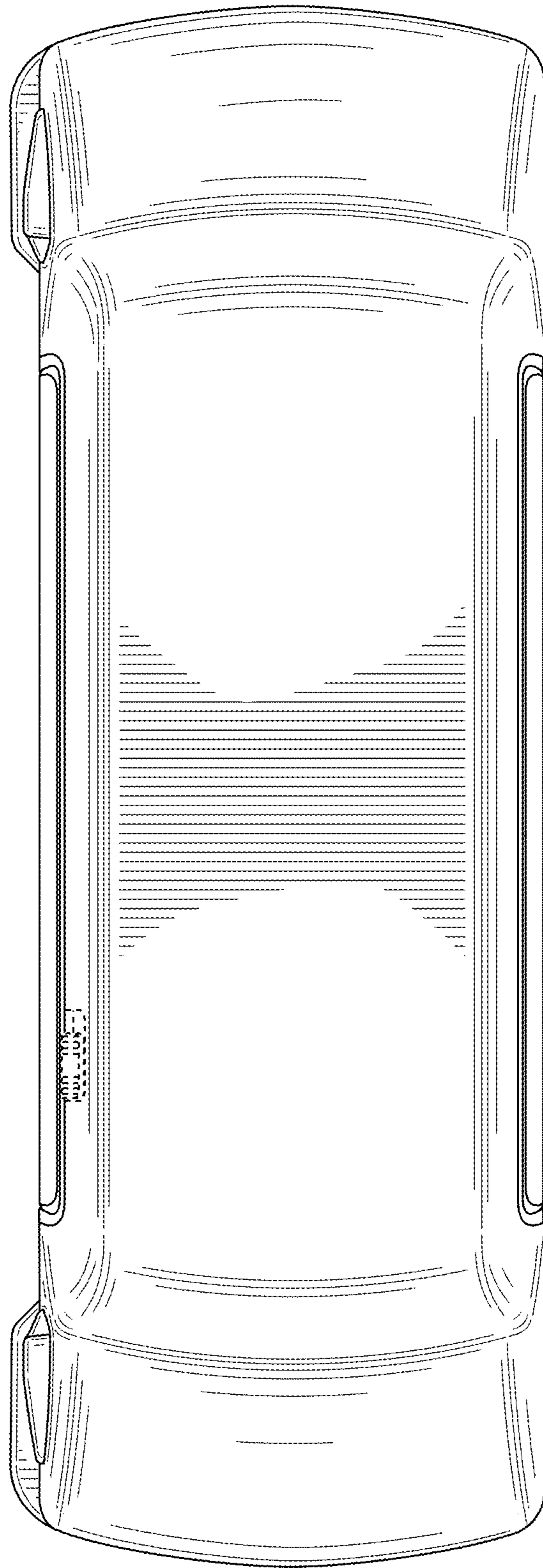

FIG. 10

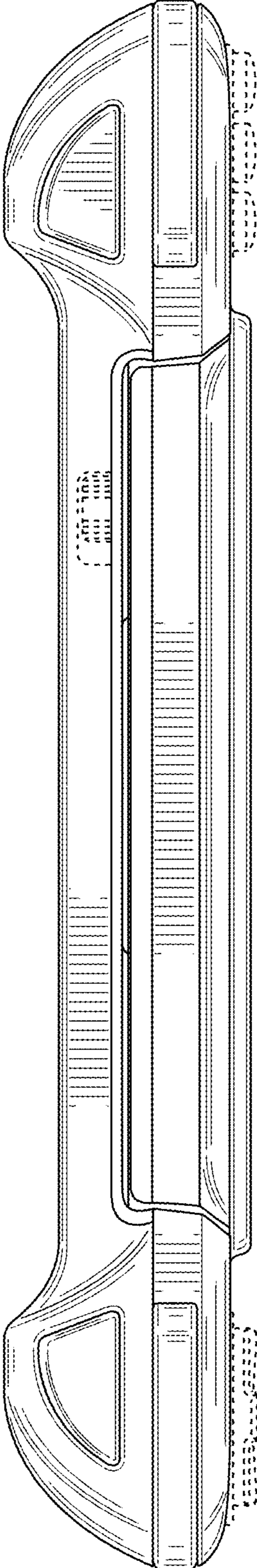

FIG. 11

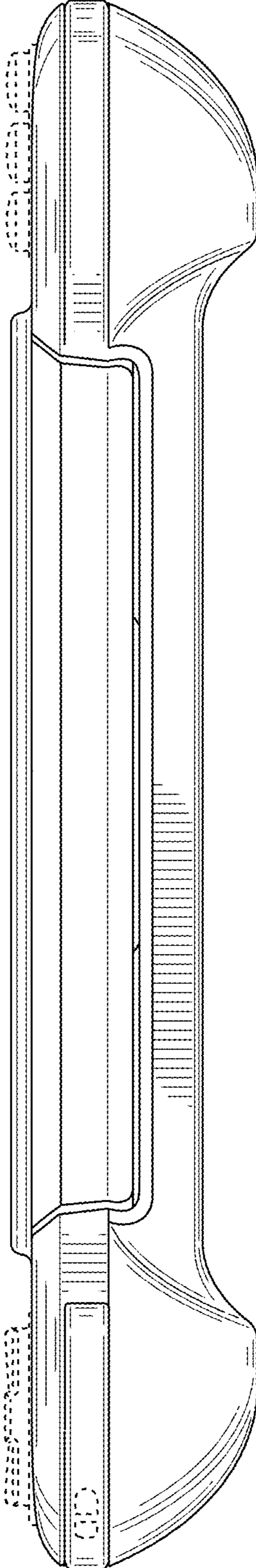

FIG. 12

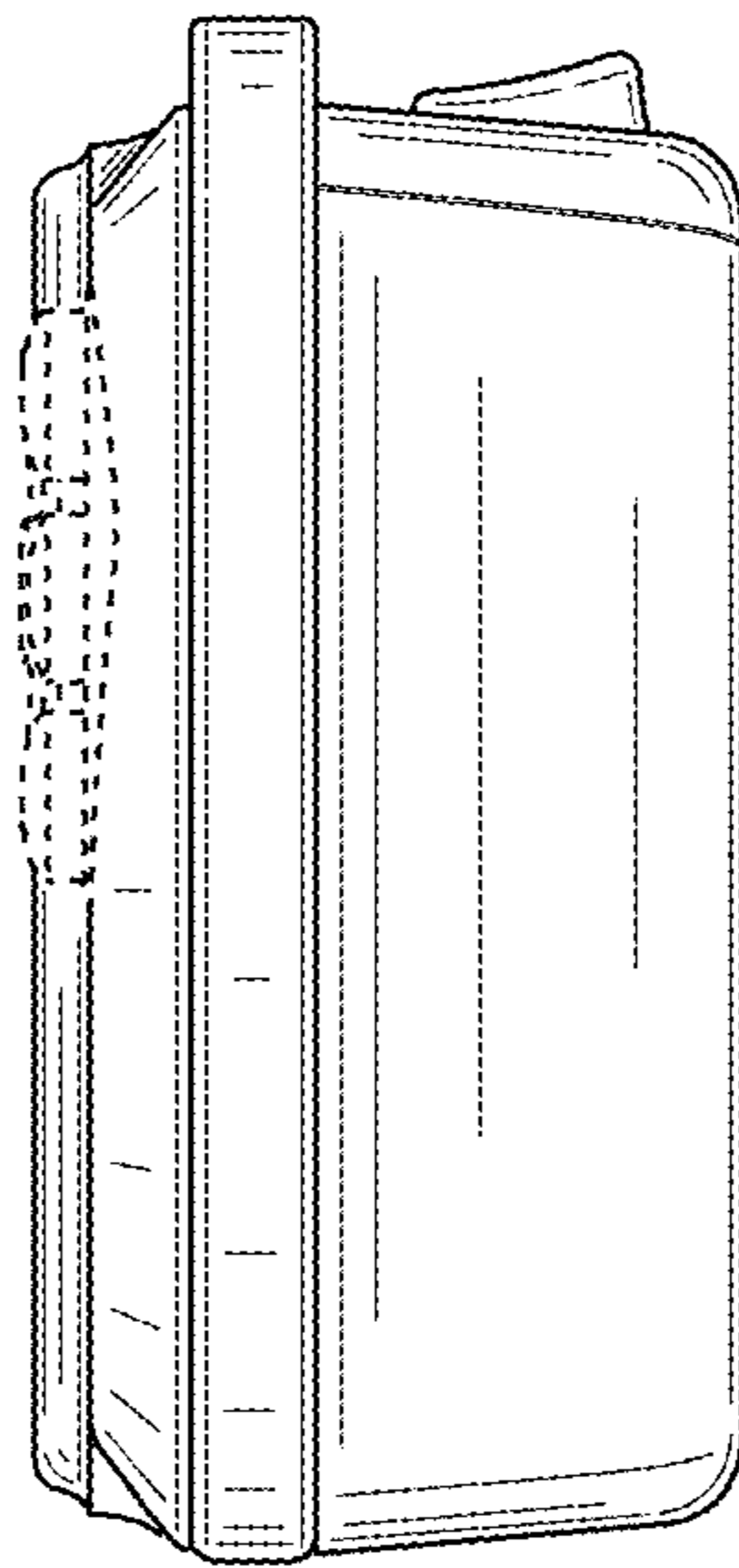

FIG. 13

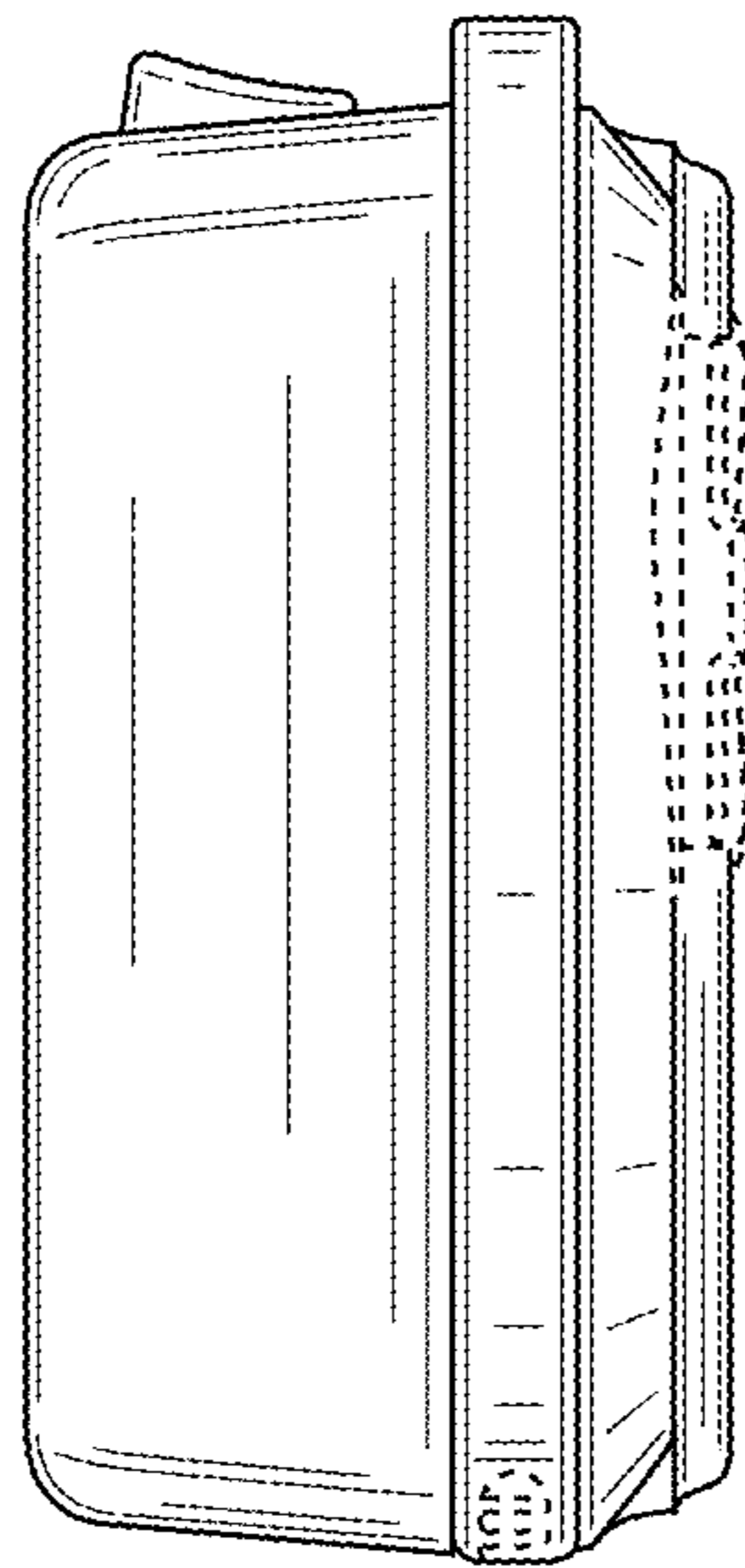

FIG. 14