



US00D686082S

(12) **United States Design Patent**
Pierre

(10) **Patent No.:** **US D686,082 S**

(45) **Date of Patent:** **** Jul. 16, 2013**

(54) **BOTTLE**

(75) Inventor: **Ivan Pierre**, Le Havre (FR)

(73) Assignee: **Sidel Participations**, Octeville sur Mer (FR)

(**) Term: **14 Years**

(21) Appl. No.: **29/405,660**

(22) Filed: **Nov. 4, 2011**

(30) **Foreign Application Priority Data**

May 6, 2011 (EM) 001274625

(51) **LOC (9) Cl.** **09-01**

(52) **U.S. Cl.**
USPC **D9/646**

(58) **Field of Classification Search**
USPC D7/514–515, 606, 613, 628; D9/600,
D9/643–646, 516, 521; 206/457, 527, 540;
220/890

See application file for complete search history.

(56) **References Cited**

U.S. PATENT DOCUMENTS

D321,642 S * 11/1991 Messemi-Petruzzelli D9/646
D417,839 S * 12/1999 Sims et al. D9/646

D585,297 S * 1/2009 Nielsen et al. D9/646
D614,500 S * 4/2010 Fernandez et al. D9/646
D614,962 S * 5/2010 Fernandez et al. D9/646
D619,474 S * 7/2010 Finlay et al. D9/645
D651,863 S * 1/2012 Ehrenhaus et al. D7/628

* cited by examiner

Primary Examiner — Sandra Morris

(74) *Attorney, Agent, or Firm* — Marshall, Gerstein & Borun LLP

(57) **CLAIM**

The ornamental design of a bottle, as shown and described.

DESCRIPTION

FIG. 1 is a front and top perspective view of a bottle that has the design.

FIG. 2 is a front and bottom perspective view of the bottle.

FIG. 3 is a rear view of the bottle.

FIG. 4 is a side view of the bottle, the opposite side view being a mirror image, but with recessed sections instead of raised sections.

FIG. 5 is a front view.

FIG. 6 is a bottom view; and,

FIG. 7 is a top view.

The broken lines represent unclaimed portions of the bottle, and form no part of the claimed design.

1 Claim, 6 Drawing Sheets

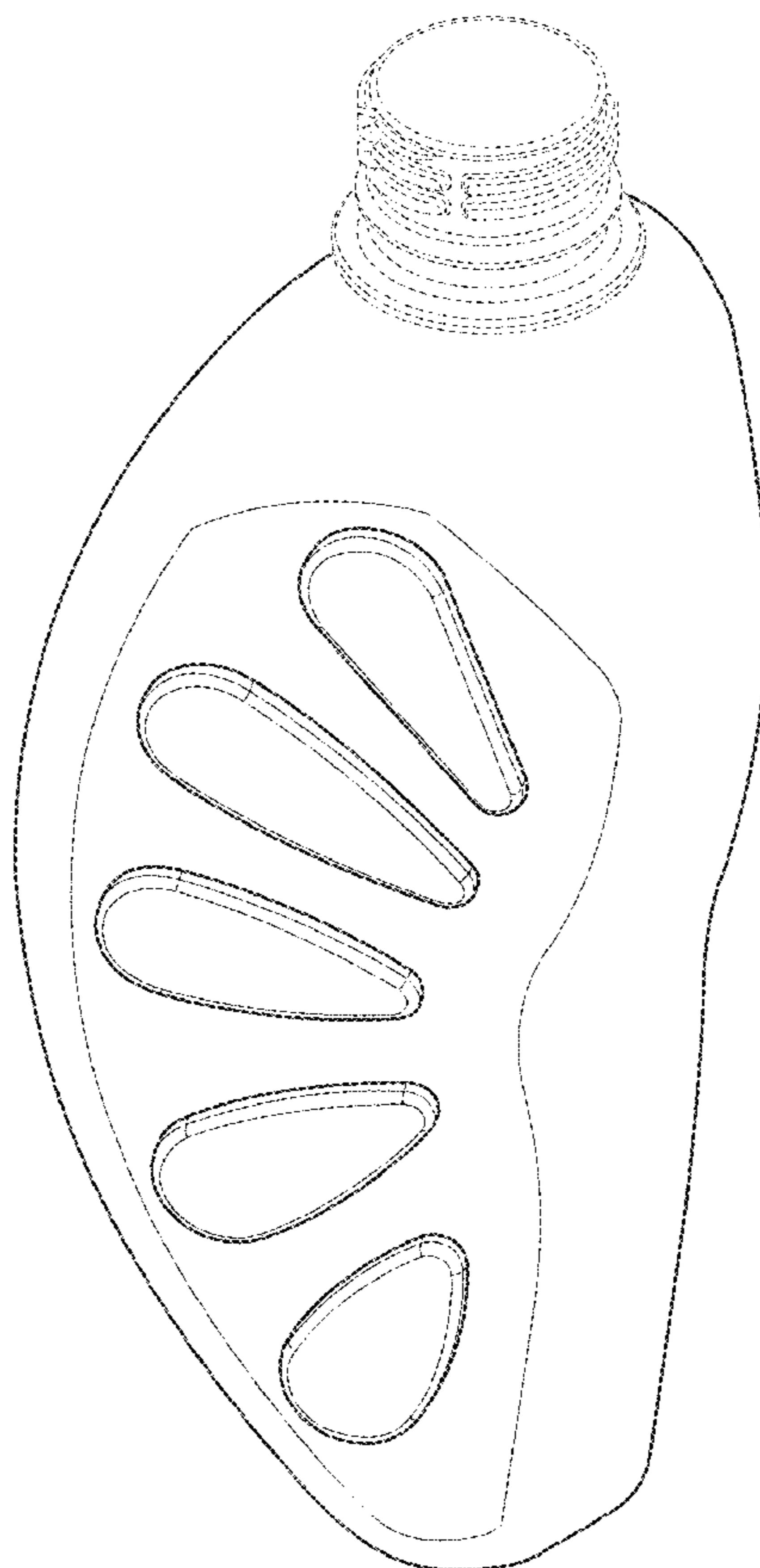

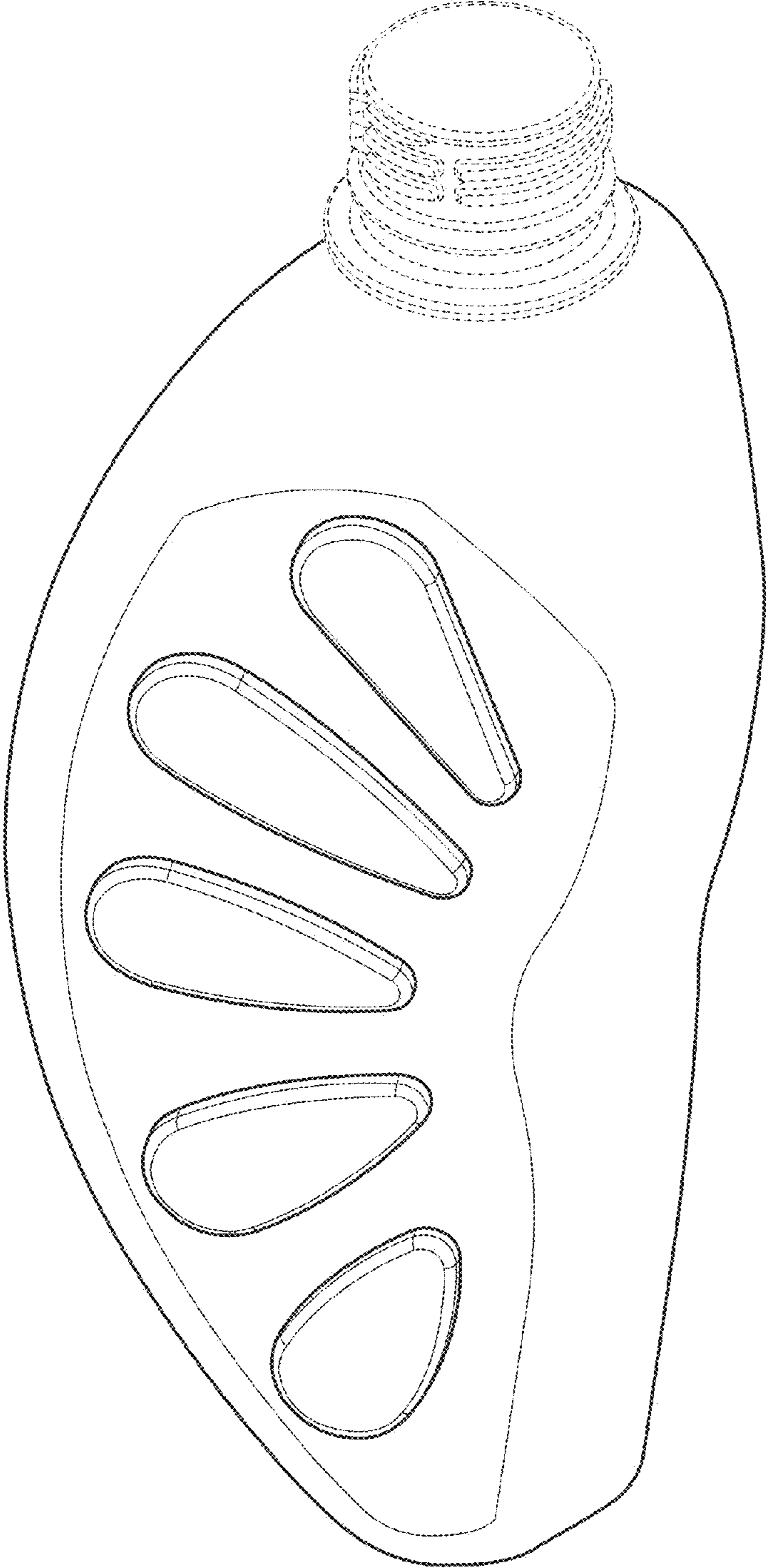

FIG. 1

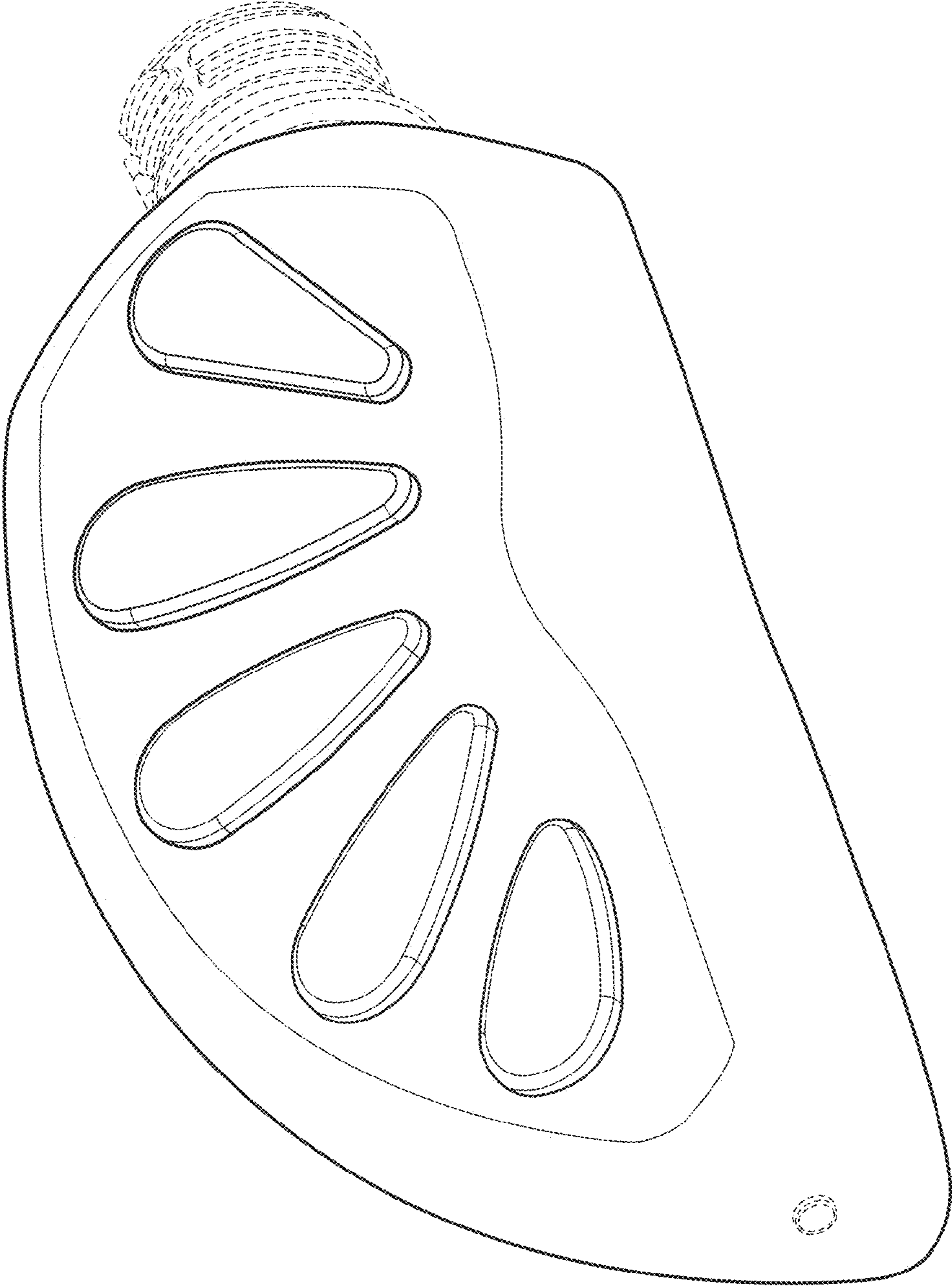

FIG. 2

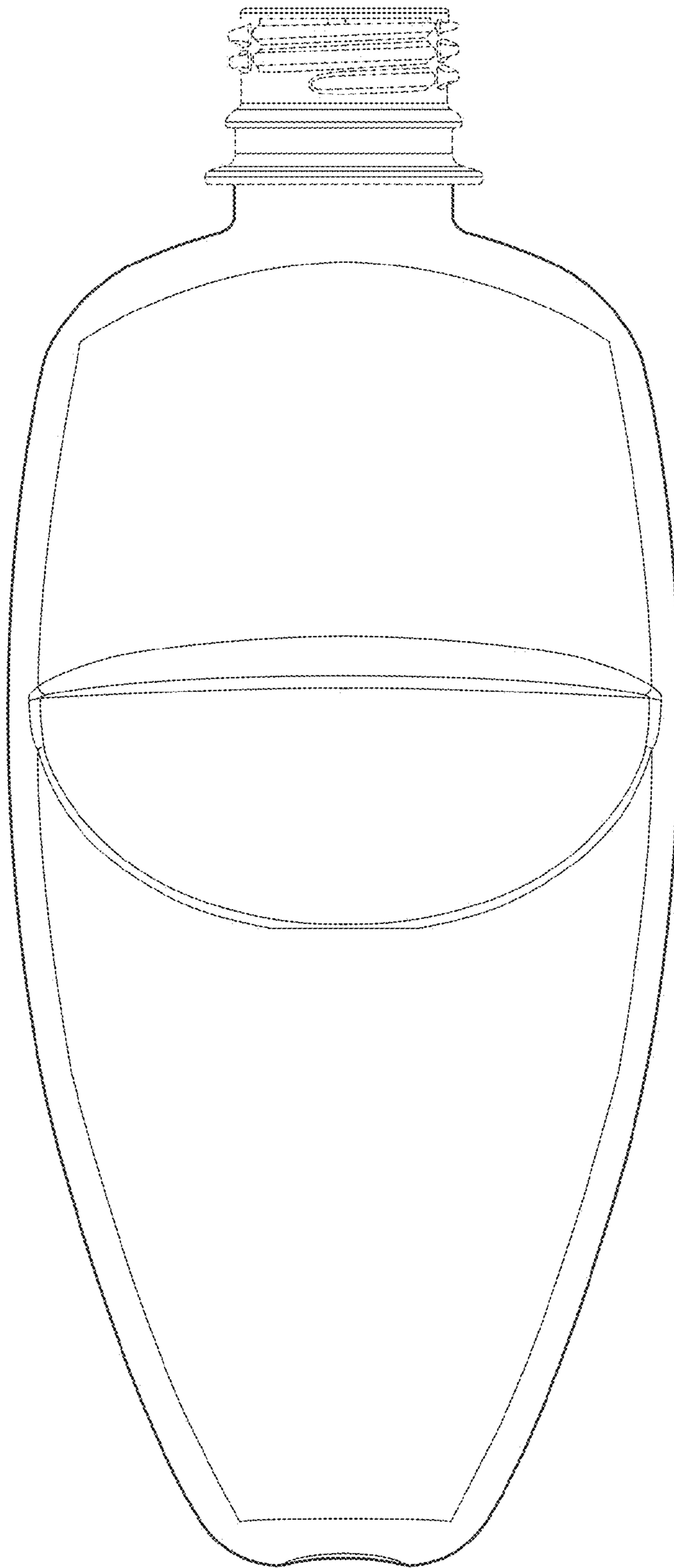

FIG. 3

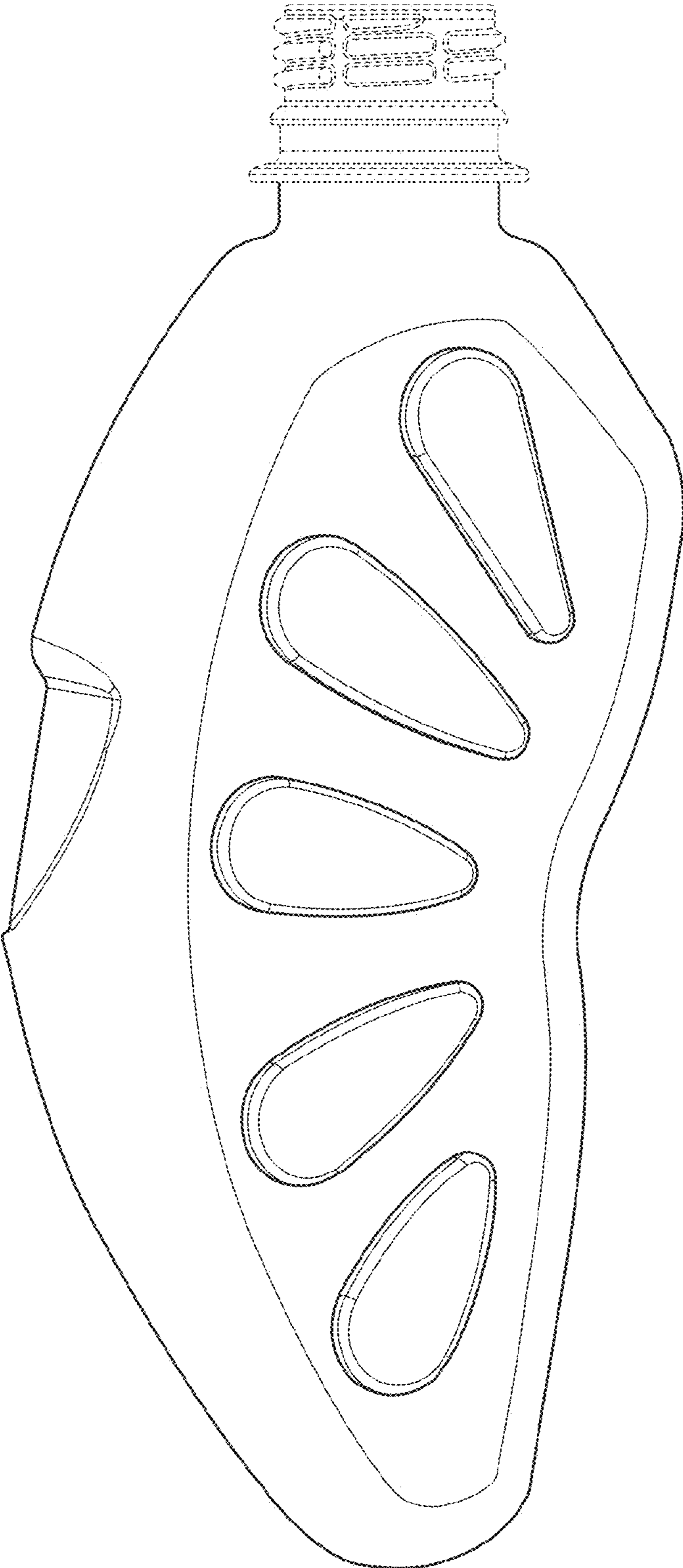

FIG. 4

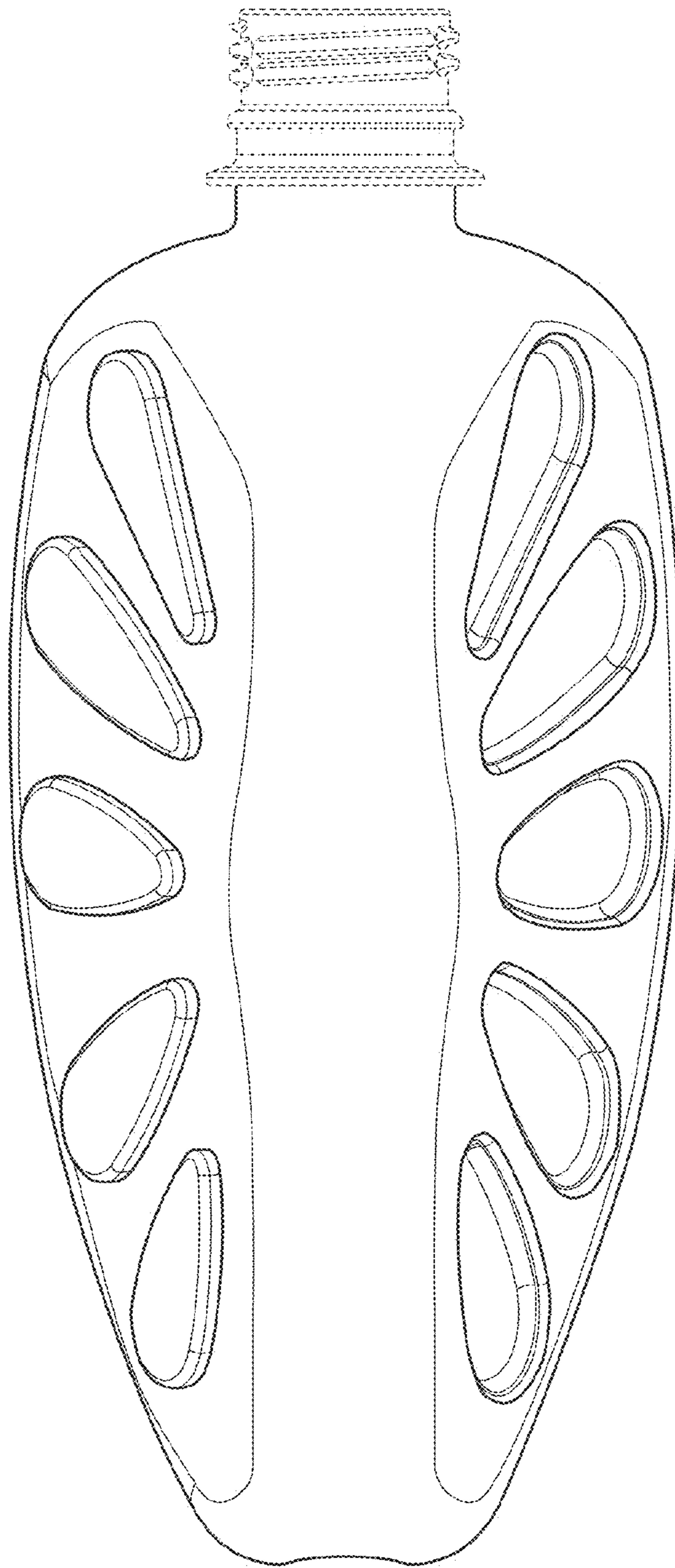

FIG. 5

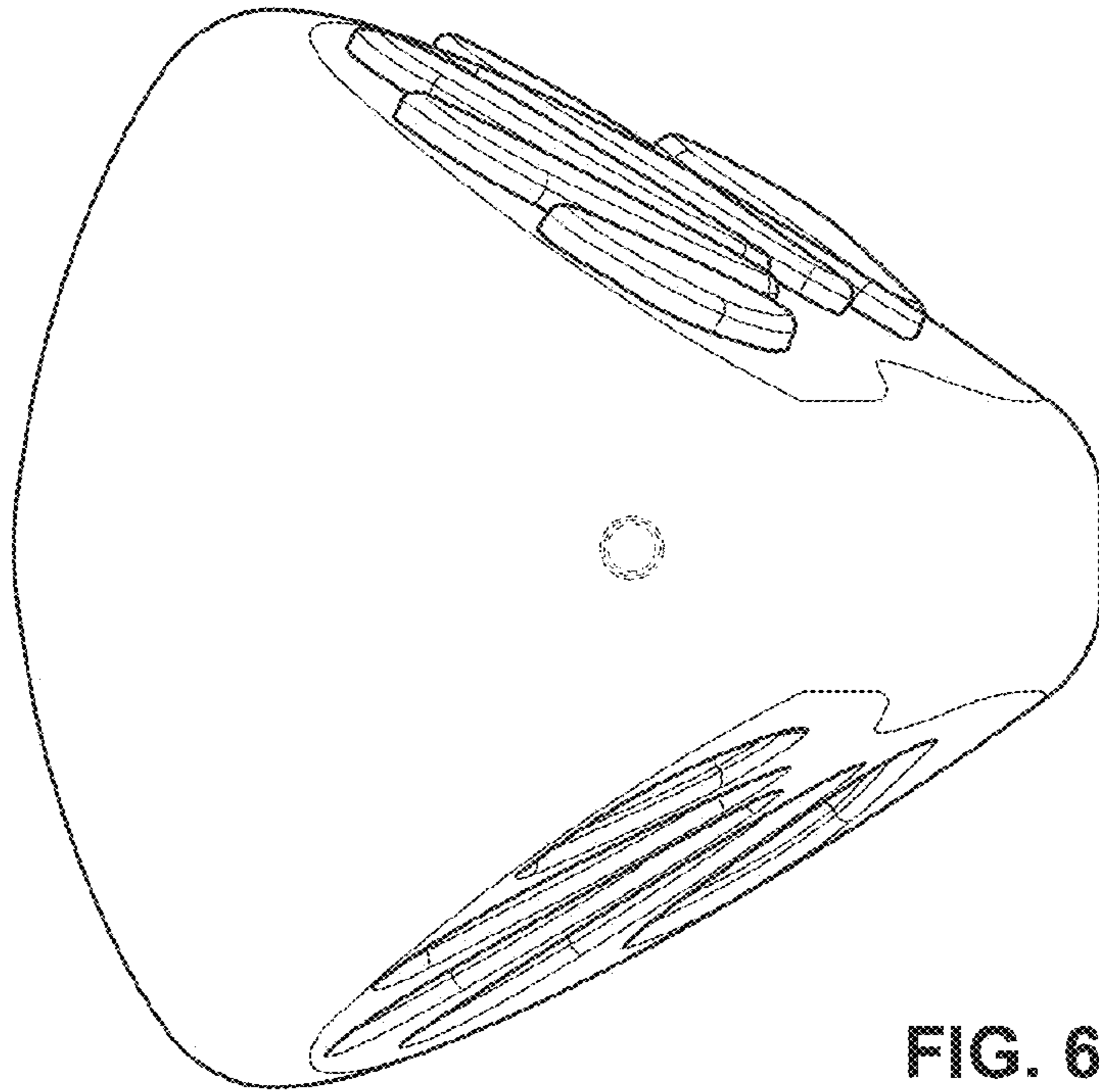

FIG. 6

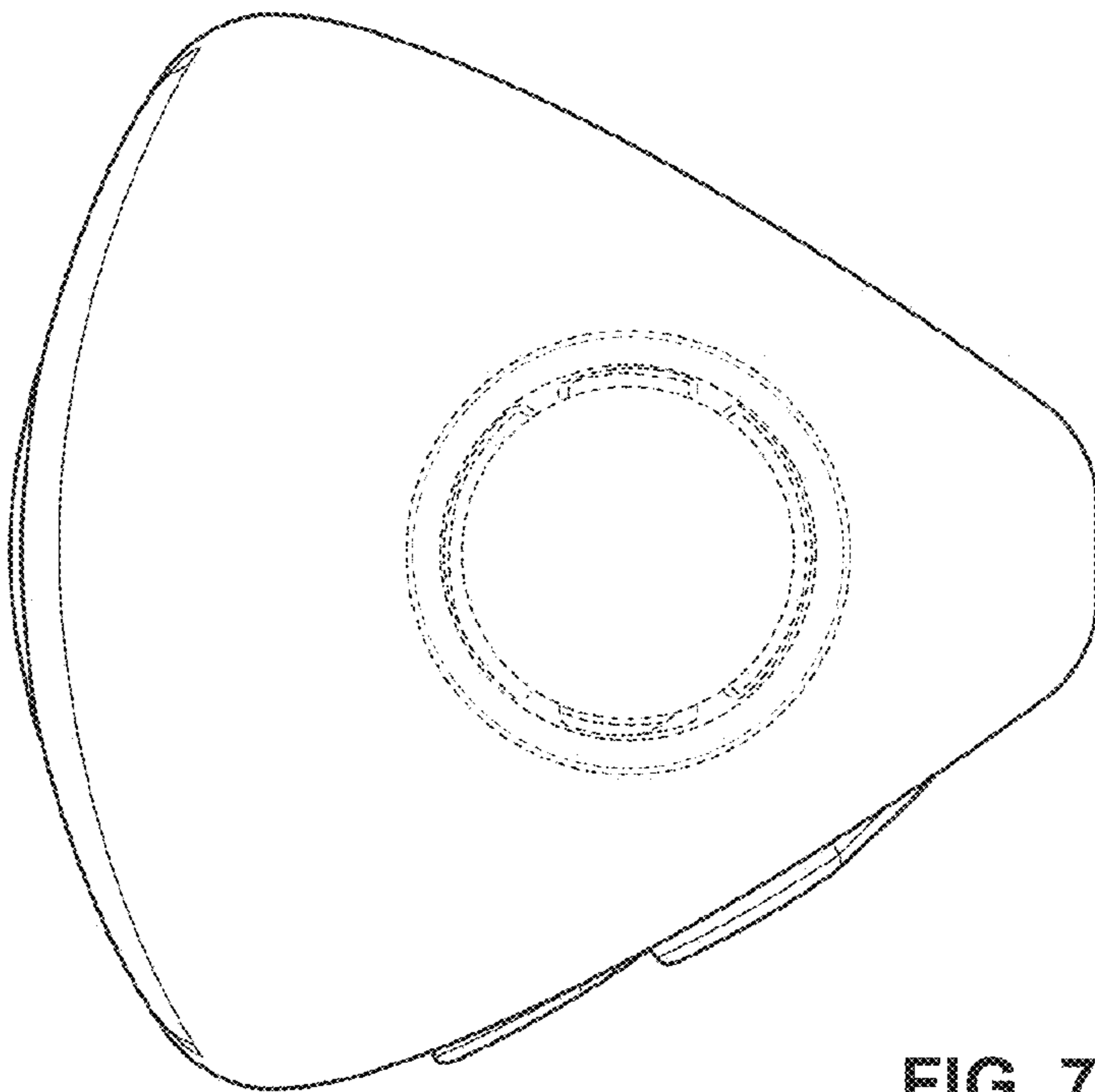

FIG. 7