



US00D686010S

(12) **United States Design Patent**
Cramer et al.

(10) **Patent No.:** **US D686,010 S**
(45) **Date of Patent:** **** Jul. 16, 2013**

(54) **GUEST CHAIR**

(75) Inventors: **E. Daniel Cramer**, Minneapolis, MN (US); **Paul A. James**, Edina, MN (US)

(73) Assignee: **Krueger International, Inc.**, Green Bay, WI (US)

(**) Term: **14 Years**

(21) Appl. No.: **29/423,241**

(22) Filed: **May 30, 2012**

(51) **LOC (9) Cl.** **06-01**

(52) **U.S. Cl.**
USPC **D6/379**

(58) **Field of Classification Search**
USPC D6/334–336, 370, 371–373, 374, D6/375, 379, 380, 716, 716.1, 716.2, 716.3, D6/716.4; 297/411.42, 411.43, 445.1, 446.1, 297/449.1, 452.21

See application file for complete search history.

(56) **References Cited**

U.S. PATENT DOCUMENTS

D358,041 S * 5/1995 Watts D6/379
D405,286 S * 2/1999 James et al. D6/379
D409,408 S * 5/1999 James et al. D6/379

D491,756 S 6/2004 Nemeth
D571,119 S * 6/2008 Leonetti et al. D6/379
D580,664 S 11/2008 Cramer et al.
D580,676 S * 11/2008 Cramer et al. D6/379
D586,131 S 2/2009 Cramer et al.
D615,767 S 5/2010 Griepentrog et al.
D644,048 S 8/2011 Blomstrom
D651,015 S * 12/2011 Jordan et al. D6/379

OTHER PUBLICATIONS

Bernhardt Oxford Chair.

* cited by examiner

Primary Examiner — Mimosa De

(74) *Attorney, Agent, or Firm* — Andrus, Sceales, Starke & Sawall, LLP

(57) **CLAIM**

The ornamental design for a guest chair, as shown and described.

DESCRIPTION

FIG. 1 is an isometric view of a guest chair;
FIG. 2 is a right side view thereof, wherein the left side view is a mirror image;
FIG. 3 is a front view thereof;
FIG. 4 is a back view thereof; and,
FIG. 5 is a top view thereof.

1 Claim, 3 Drawing Sheets

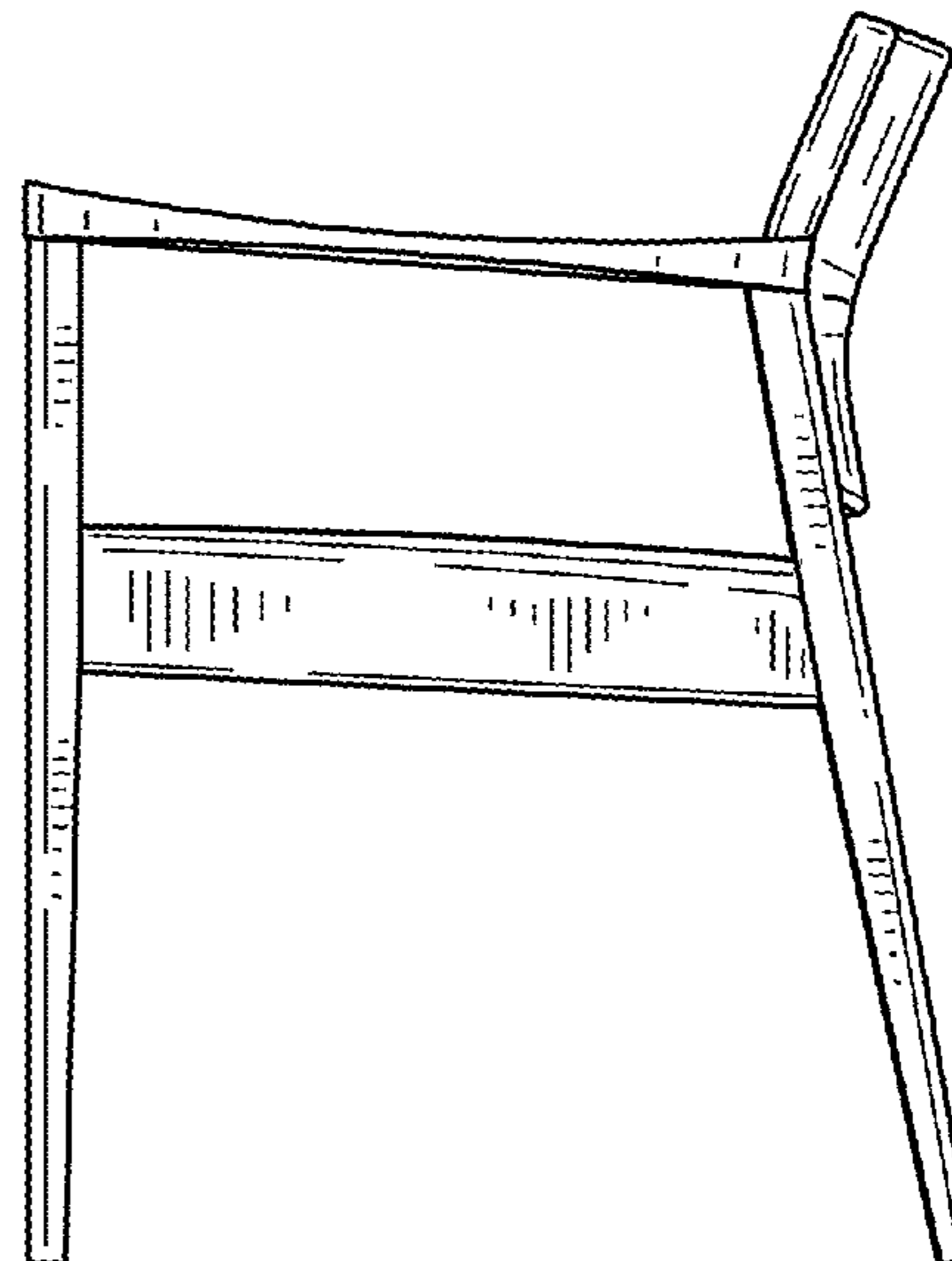
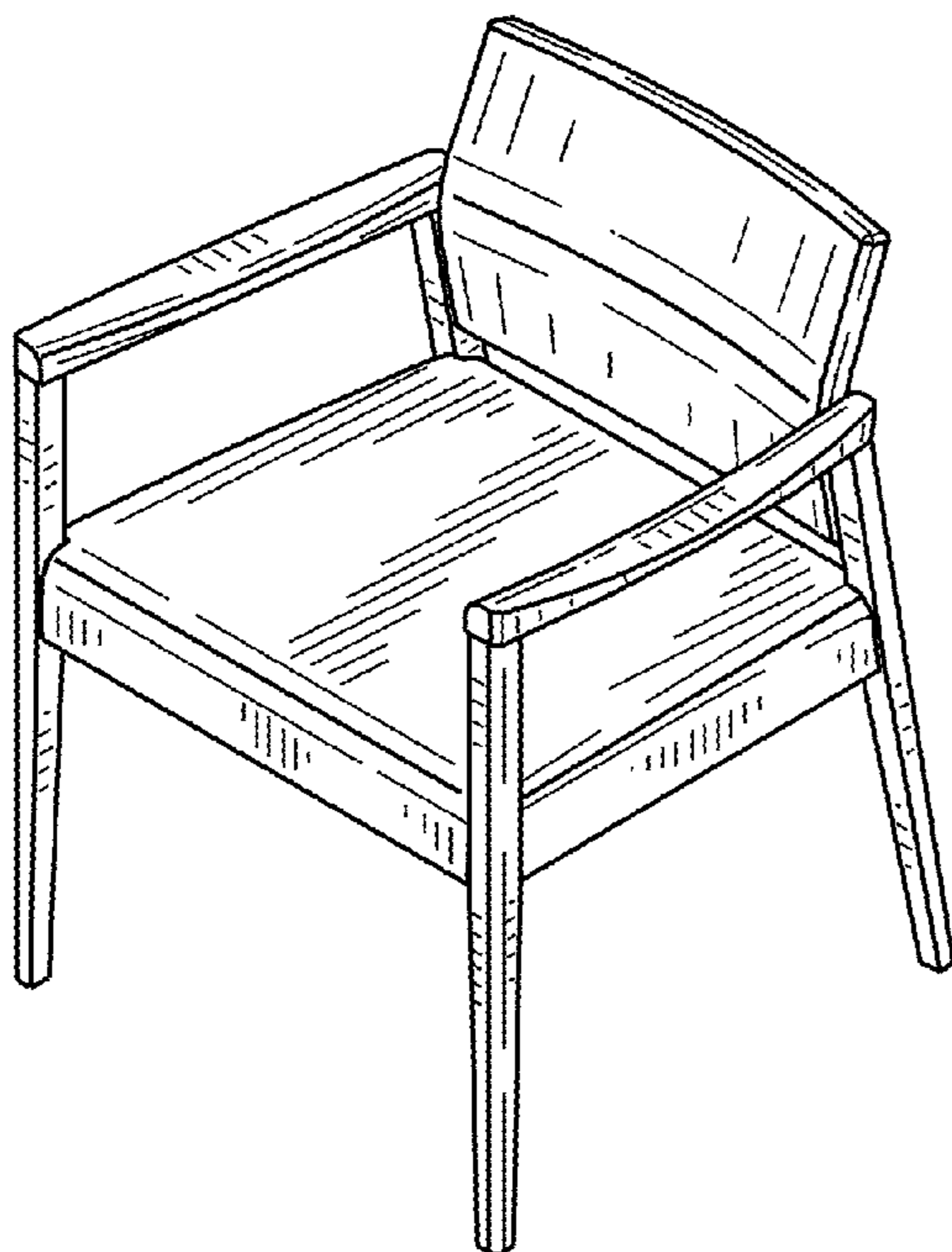

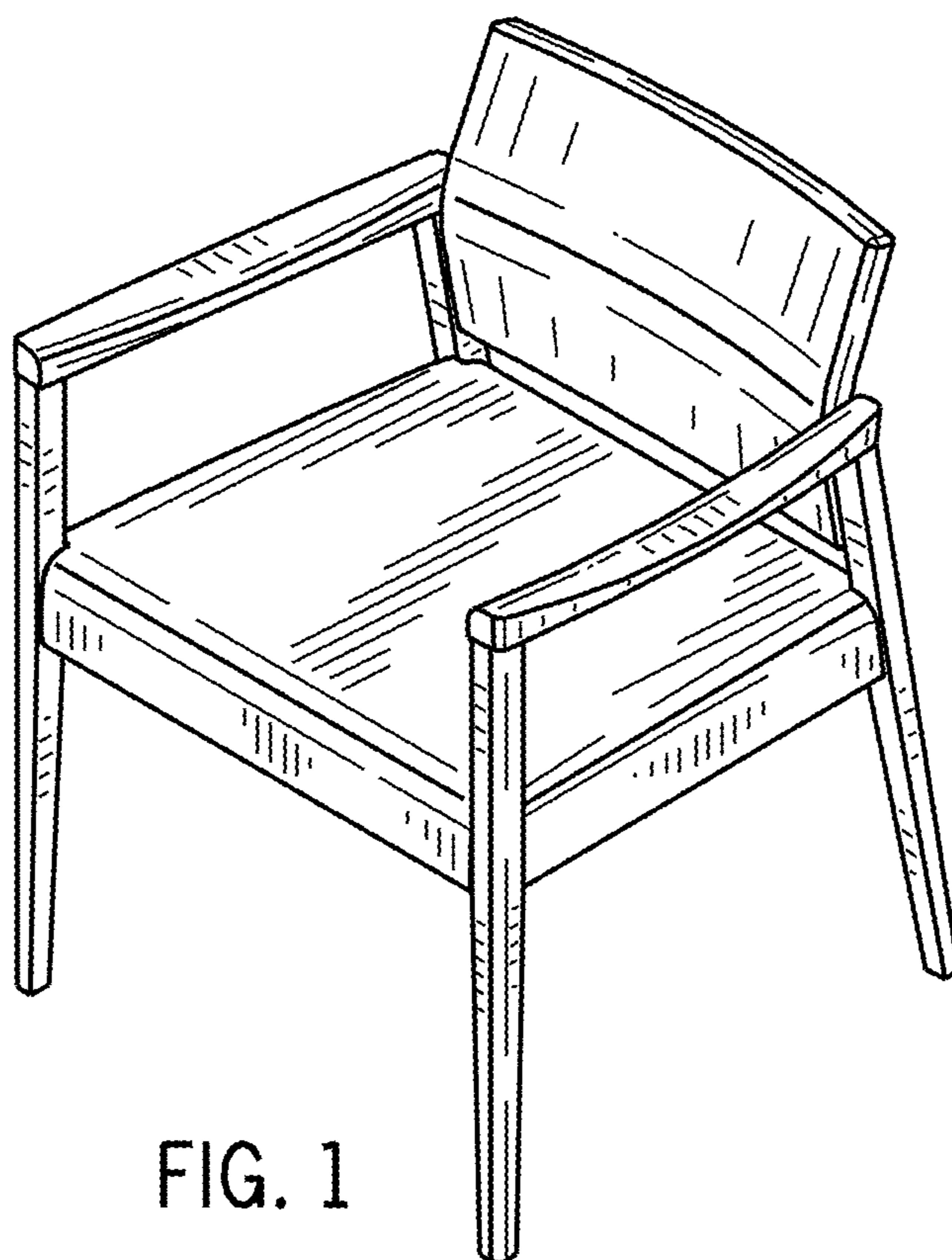

FIG. 1

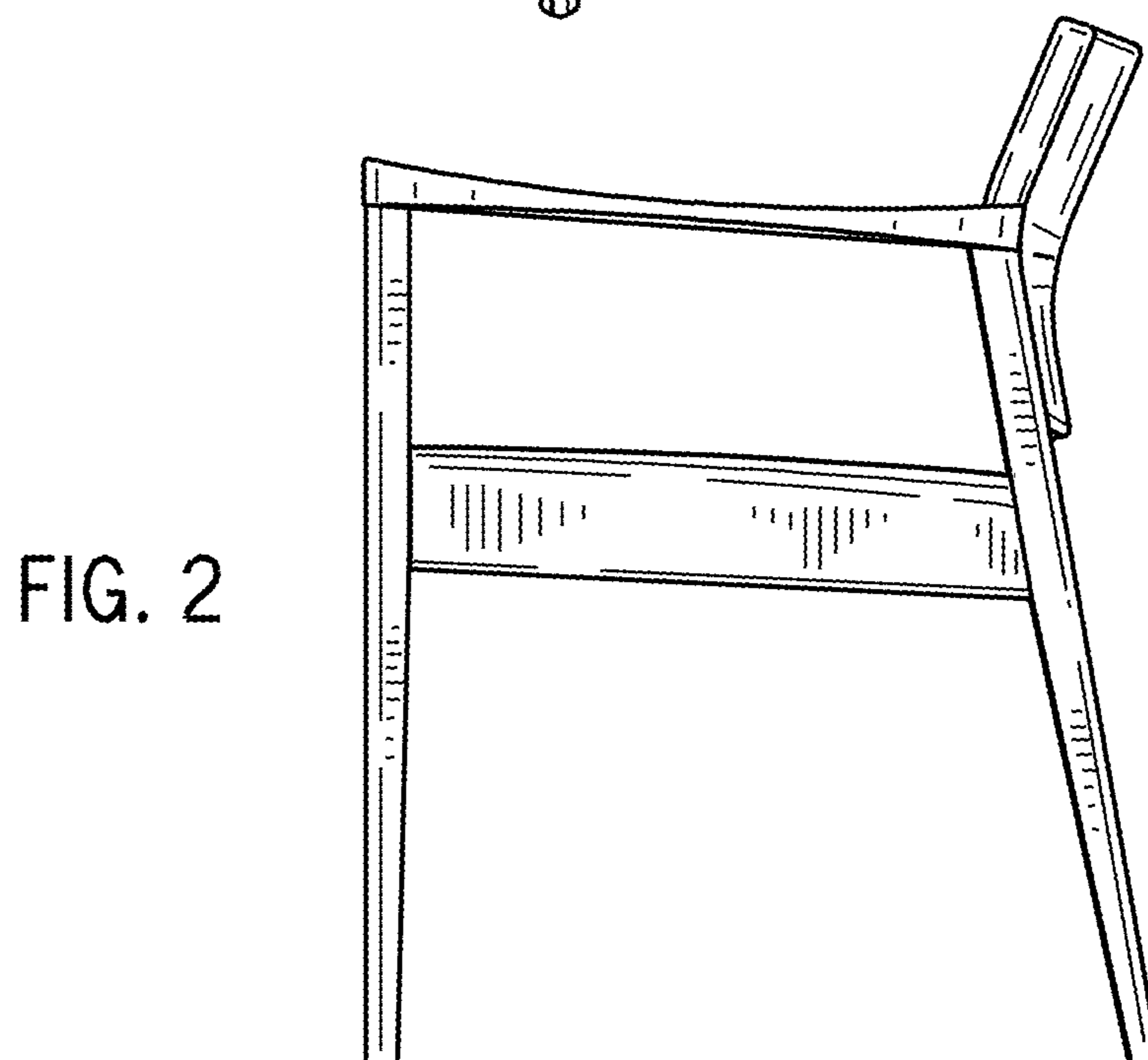

FIG. 2

FIG. 3

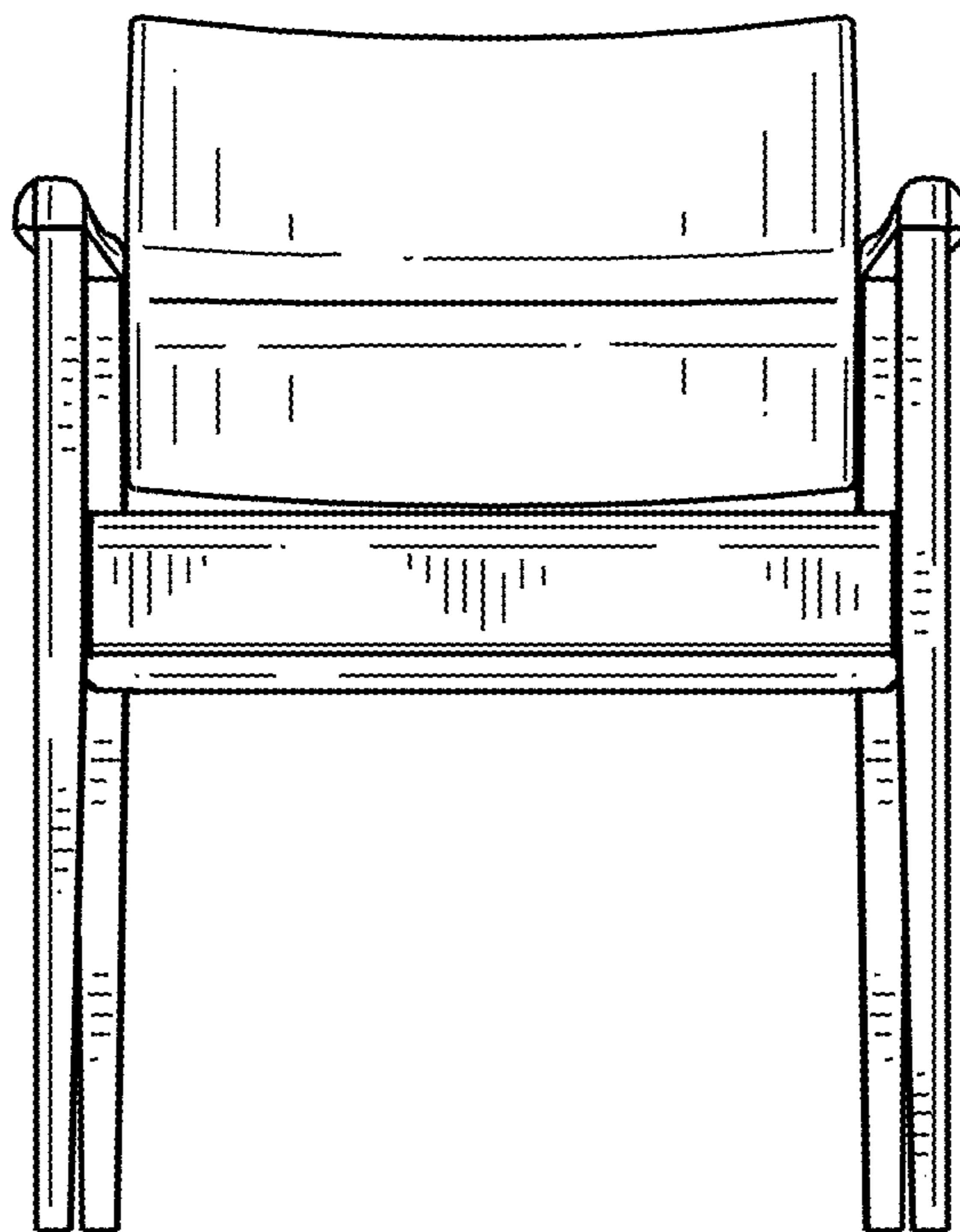
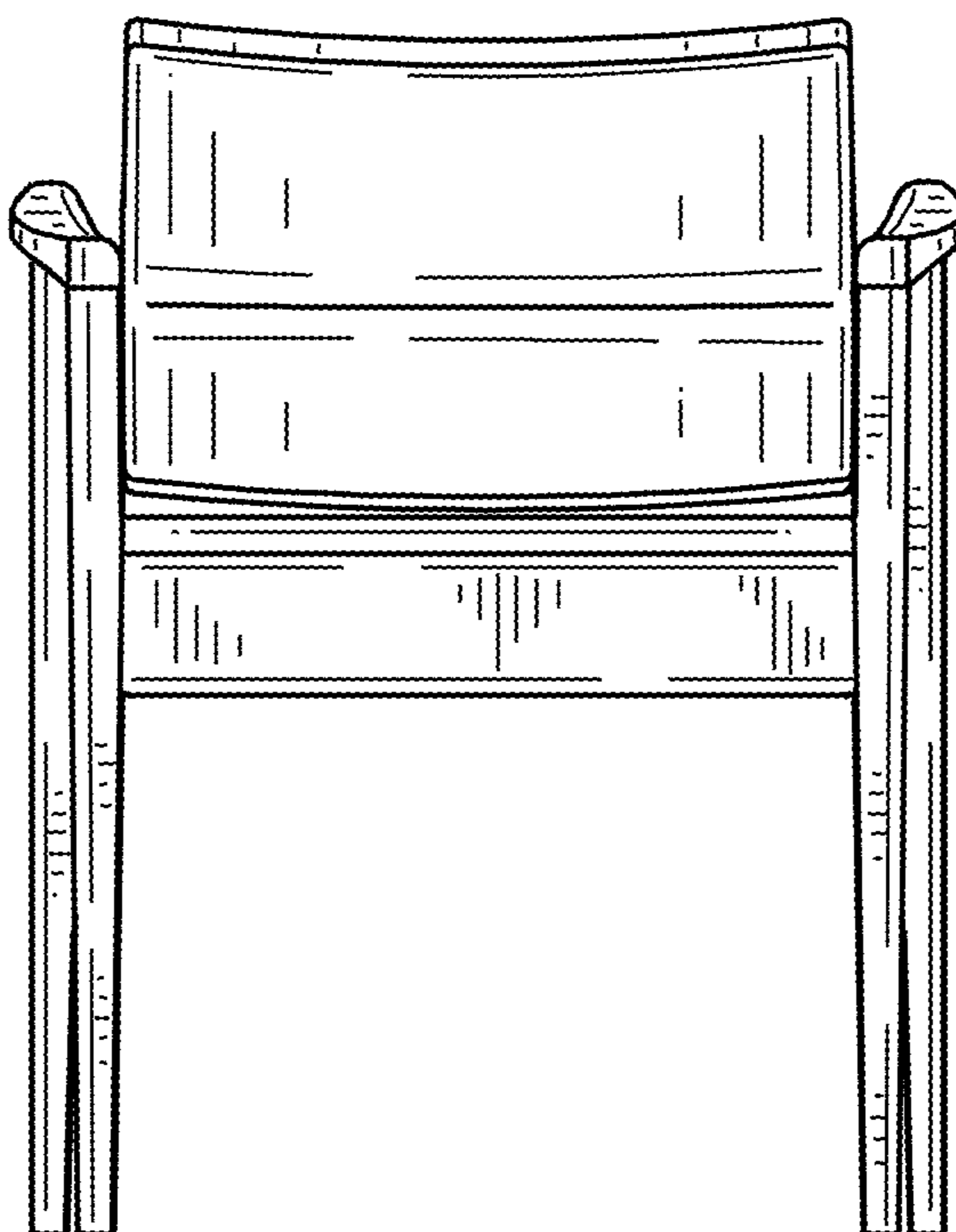

FIG. 4



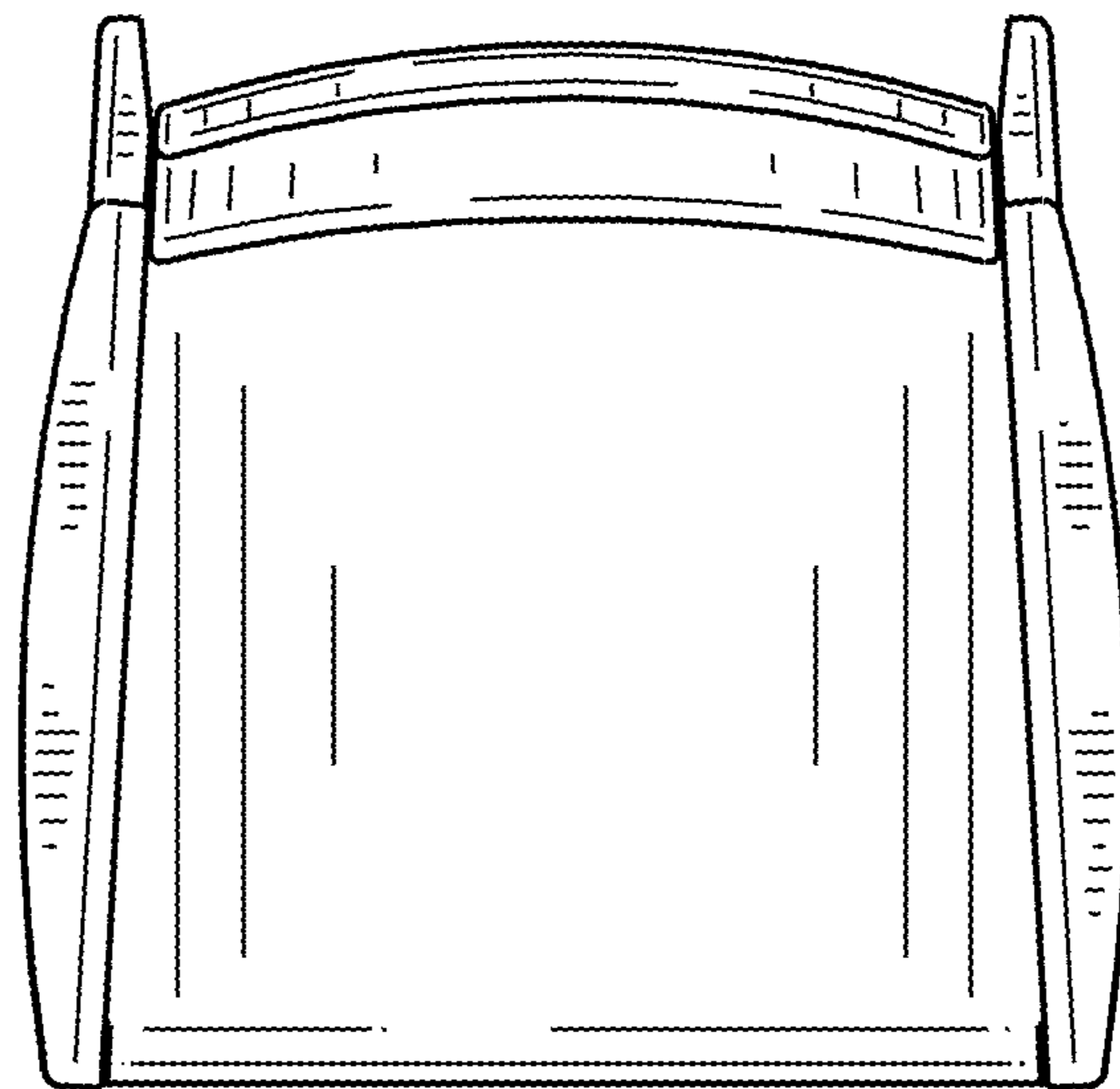

FIG. 5