



US00D686003S

(12) **United States Design Patent**
Arko et al.

(10) **Patent No.:** **US D686,003 S**
(45) **Date of Patent:** **** *Jul. 16, 2013**

(54) **SEAT PORTION**

(75) Inventors: **Robert Peter Arko**, San Francisco, CA (US); **John Hamilton**, San Rafael, CA (US); **Matthew Hollingsworth**, San Francisco, CA (US)

(73) Assignee: **Steelcase Inc.**, Grand Rapids, MI (US)

(*) Notice: This patent is subject to a terminal disclaimer.

(**) Term: **14 Years**

(21) Appl. No.: **29/390,353**

(22) Filed: **Apr. 22, 2011**

(51) **LOC (9) Cl.** **06-01**

(52) **U.S. Cl.**

USPC **D6/334**

(58) **Field of Classification Search**

USPC D6/334, 335, 337, 374, 379, 380, D6/381, 491, 492, 495, 500-502, 341; 297/118, 297/300.1, 302.1, 311, 313, 353, 354.1, 445.1, 297/446.1, 446.2, 447.4, 464, 465, 900, DIG. 2, 297/DIG. 7; 5/12.1, 12.2

See application file for complete search history.

(56) **References Cited**

U.S. PATENT DOCUMENTS

D169,911 S	6/1953	Netzer	
D170,088 S	7/1953	Hoffman	
D170,122 S	8/1953	Jorgensen	
D175,877 S	10/1955	Bartolucci	
D179,829 S	3/1957	Wilson	
D186,308 S	10/1959	Knoll	
D188,049 S *	5/1960	Galloway D6/381
2,965,160 A	12/1960	Knoll	
2,979,122 A	4/1961	Knoll	
2,985,892 A	5/1961	Garrigus, Sr. et al.	
2,997,724 A	8/1961	Heumann	

D192,913 S *	5/1962	Wilson D6/336
3,093,410 A *	6/1963	Wilson 297/119
3,127,216 A *	3/1964	Clouse 297/134
D202,339 S *	9/1965	McLee D6/336
3,328,810 A	7/1967	Berman	
3,380,777 A	4/1968	Bennett	
4,188,066 A	2/1980	Terenzoni	
D272,968 S	3/1984	Fairaizen	
4,621,381 A	11/1986	Schramek	
D329,543 S	9/1992	Shields	

(Continued)

OTHER PUBLICATIONS

Metropolitan Furniture Corporation. "Contract Bench". Interiors catalog. Copyright Apr. 1961.

(Continued)

Primary Examiner — Sandra Snapp

(74) *Attorney, Agent, or Firm* — Quarles & Brady LLP

(57) **CLAIM**

The ornamental design for a seat portion, as shown and described.

DESCRIPTION

FIG. 1 is a left, top, front perspective view of a seat portion according to our new design, the bottom thereof is unseen in use;

FIG. 2 is a top, rear perspective view from the left side thereof;

FIG. 3 is a front elevational view thereof;

FIG. 4 is a rear elevational view thereof;

FIG. 5 is a left side elevational view thereof; and,

FIG. 6 is a top plan view thereof.

The broken line representations in the figures are for the purpose of illustrating unclaimed boundaries. The broken lines are thus not part of the claim.

The nature of this product is a portion of seating furniture, for example a chair, lounge, couch and the like.

1 Claim, 3 Drawing Sheets

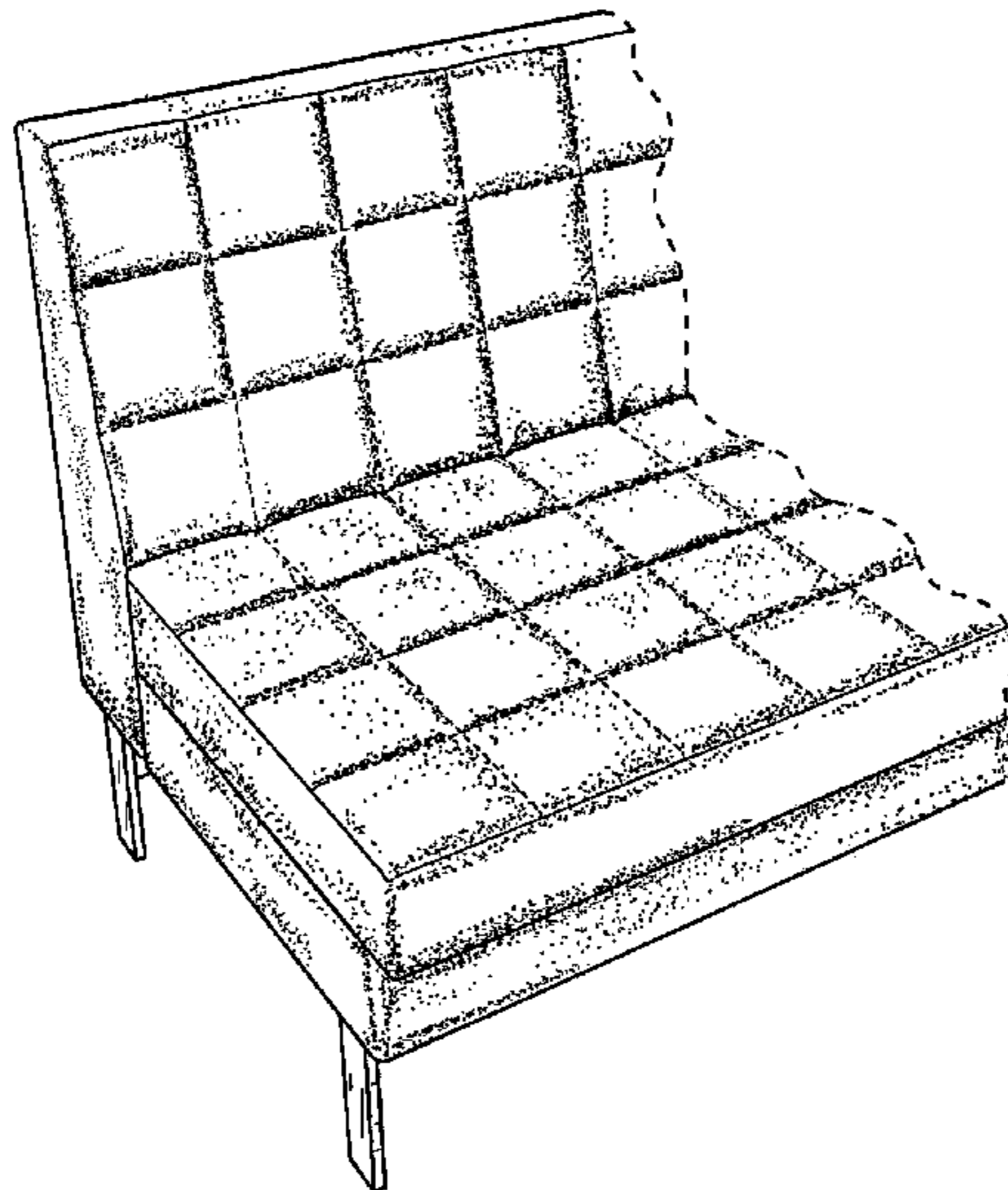

U.S. PATENT DOCUMENTS

D360,310 S	7/1995	Stamberg et al.	
D384,827 S	10/1997	Hutton	
D385,122 S	10/1997	Hutton	
D429,082 S	8/2000	Desombre	
D433,824 S	11/2000	King	
D443,989 S	6/2001	Gomez	
D444,305 S	7/2001	Mourgue	
D455,281 S	4/2002	Andersen et al.	
D455,282 S	4/2002	Andersen et al.	
D473,723 S	4/2003	Pesso	
D477,152 S	7/2003	Levy	
D484,327 S	12/2003	Ricci	
D485,086 S	1/2004	Gomez	
D486,652 S	2/2004	Nemeth	
D489,188 S	5/2004	Ricci	
D490,630 S	6/2004	Pesso	
D495,153 S	8/2004	Ricci	
D495,514 S	9/2004	Ricci	
D495,893 S	9/2004	Ricci	
D498,064 S	11/2004	Gomez	
D498,075 S	11/2004	Mourgue	
D498,941 S	11/2004	Ricci	
D499,261 S	12/2004	Ricci	
D501,330 S	2/2005	Gomez	
D505,276 S	5/2005	Cronk et al.	
D511,415 S	11/2005	Pesso	
D515,334 S	2/2006	Natuzzi	
D518,654 S	4/2006	Pesso	
D527,541 S	9/2006	Natuzzi	
D533,365 S	12/2006	Martin	
D538,054 S	3/2007	Lissoni	
D538,549 S	* 3/2007	Spear	D6/381
D539,561 S	4/2007	Martin et al.	
D542,560 S	5/2007	Ricci	
D544,233 S	* 6/2007	Hutton	D6/378
D545,070 S	6/2007	Hutton	
D549,470 S	8/2007	Hutton	
D569,111 S	5/2008	Swanson	
D569,112 S	5/2008	Swanson	
D569,113 S	5/2008	Lewis	
D571,574 S	6/2008	Natuzzi	
D572,916 S	7/2008	Galardo et al.	
D573,358 S	7/2008	Gharabegian	
D577,211 S	9/2008	Natuzzi	
D577,222 S	9/2008	Natuzzi	
D577,506 S	9/2008	Natuzzi	
D580,670 S	11/2008	Weiss	
D583,585 S	12/2008	Weiss	
D586,131 S	2/2009	Cramer et al.	
D586,156 S	2/2009	Schweikarth et al.	
D586,590 S	* 2/2009	Schweikarth et al.	D6/492
D590,171 S	4/2009	Natuzzi	
D590,623 S	4/2009	Natuzzi	
D591,970 S	5/2009	Weiss	
D592,416 S	5/2009	Weiss	
D600,037 S	9/2009	Natuzzi	
D601,825 S	10/2009	Starck	
D603,617 S	11/2009	Weiss	

D603,618 S	11/2009	Weiss
D603,619 S	11/2009	Weiss
D604,957 S	12/2009	Weiss
D607,227 S	1/2010	Massaud
D613,960 S	4/2010	Griepentrog et al.
D614,419 S	4/2010	Andersen
D614,884 S	5/2010	Metcalf et al.
D615,315 S	5/2010	Andersen
D615,766 S	5/2010	Andersen
D618,007 S	6/2010	Andersen
D623,869 S	9/2010	Andersen
D628,403 S	12/2010	Starck
D630,029 S	1/2011	Delbridge

OTHER PUBLICATIONS

Metropolitan Furniture Corporation. "Contract B". Interiors catalog. Copyright Apr. 1961.

Metropolitan Furniture Corporation. "Contract C". Interior Design catalog. Copyright Aug. 1962.

Metropolitan Furniture Corporation. "506JVision". Palto alto Times, Copyright Nov. 19, 1957.

NLBAA Sofa, First Proof Journal Oregon Journal of CA 2-5511, Sunday, Oct. 11. No. 6226 Journal.

NLBAA Sofa, Sunset Magazine, Mar. 1961.

Metropolitan Furniture Company. "Sofa". Retailing Daily, Aug. 19, 1954, p. 10.

Metropolitan Furniture Company. "Chairs". Pennisula Living, Sep. 14-15, 1957, p. 25.

Metropolitan Furniture Company. "Sofa". Nat'l Furniture Review Aug. 15, 1961.

Metropolitan Furniture Company. Pierce Sofa, Nat'l Furniture Review, Aug. 15, 1961.

Metropolitan Furniture Company. Elegance/NLBAA Contract B Series, Contract Magazine, Feb. 1961.

Metropolitan Furniture Company. "Contract H". Metropolitan Furniture Sales Brochure 1961.

Metropolitan Furniture Company. "Contract B sofa, table and chair" National Furniture Review, Apr. 20, 1962.

Metropolitan Furniture Company. "Myriad collection", Printed publication published on or around Jun. 1961.

Metropolitan Furniture Company. "Contract B Table". Metropolitan Brochure.

Advertisement from Sloane's (San Francisco). San Francisciana.

Metropolitan Furniture Company. Advertisement/Brochure.

Metropolitan Furniture Company. "Elegance at a Price". In-house Metropolitan ad/brochure.

Metropolitan Furniture Company. "Sofa". Advertisement.

Sloane's (San Francisco) Sofas and Chairs. Advertisement.

Metropolitan Furniture Company. "Metropolitan's high-back chair".

Metropolitan Furniture Company. "Sofa". Fraser's /Berkeley Telegraph and Channing advertisement.

Metropolitan Furniture Company. "The Weekender Sofa/Bed". Furniture Forum catalog, section 1, p. 32.

* cited by examiner

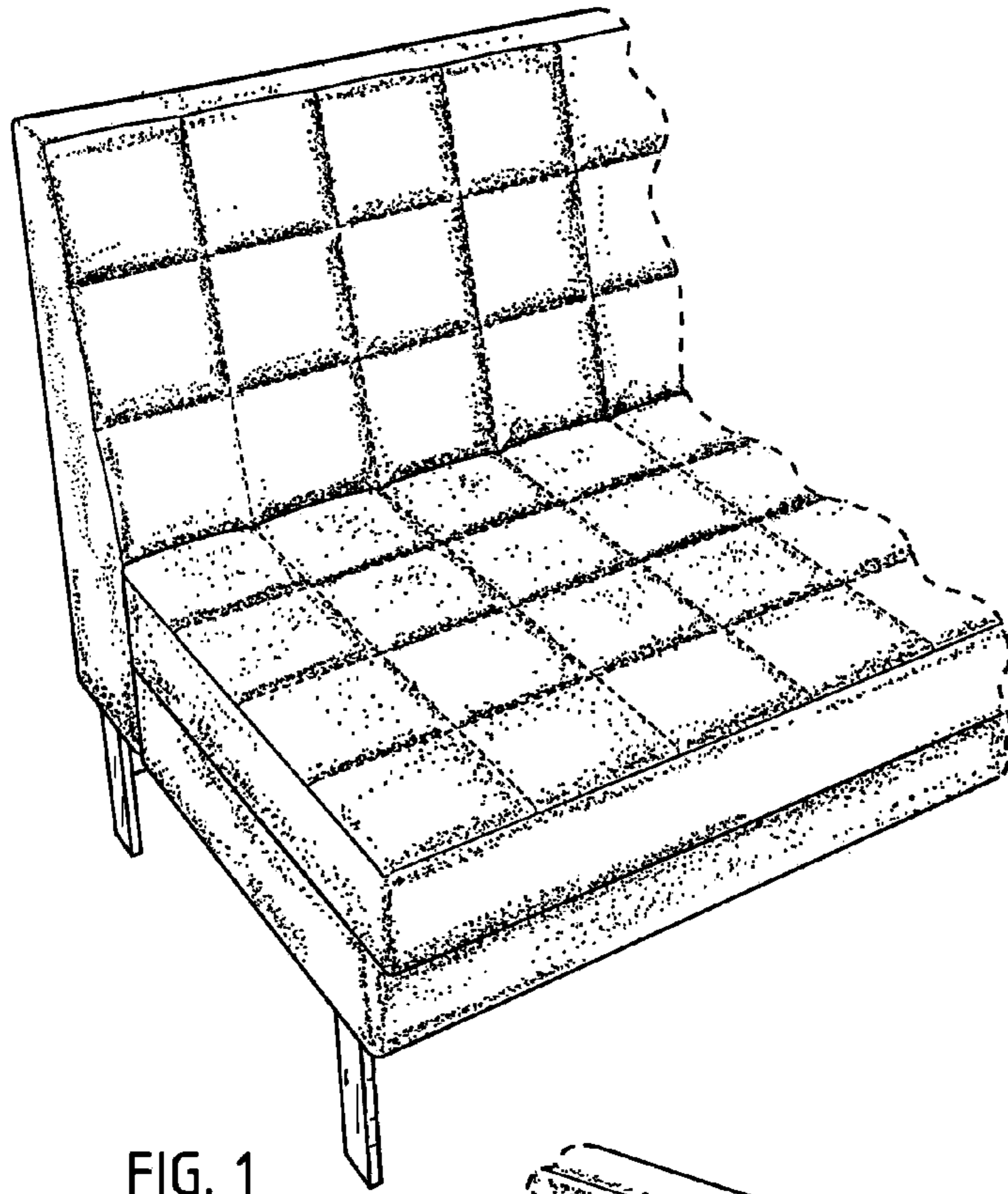

FIG. 1

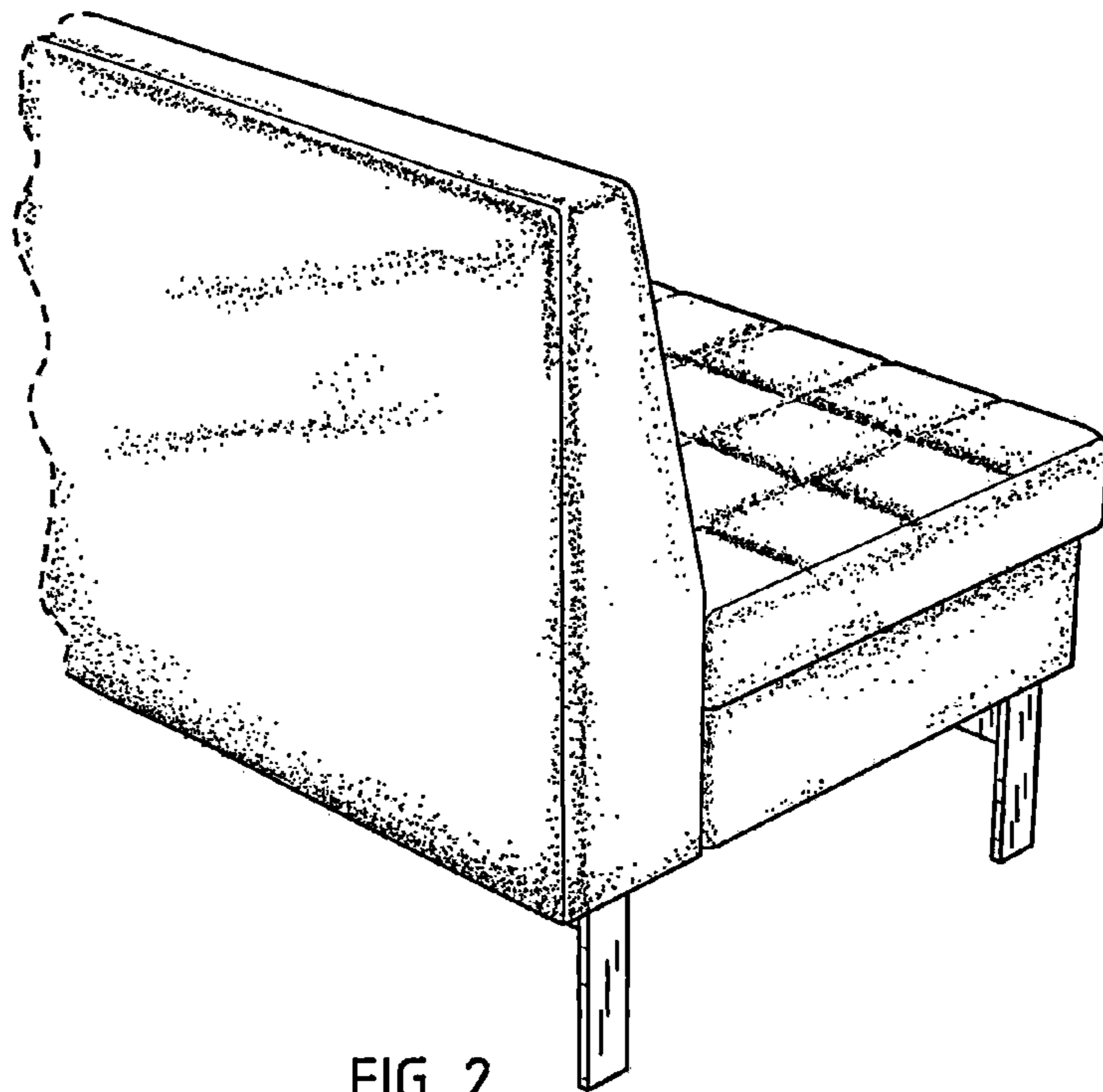

FIG. 2

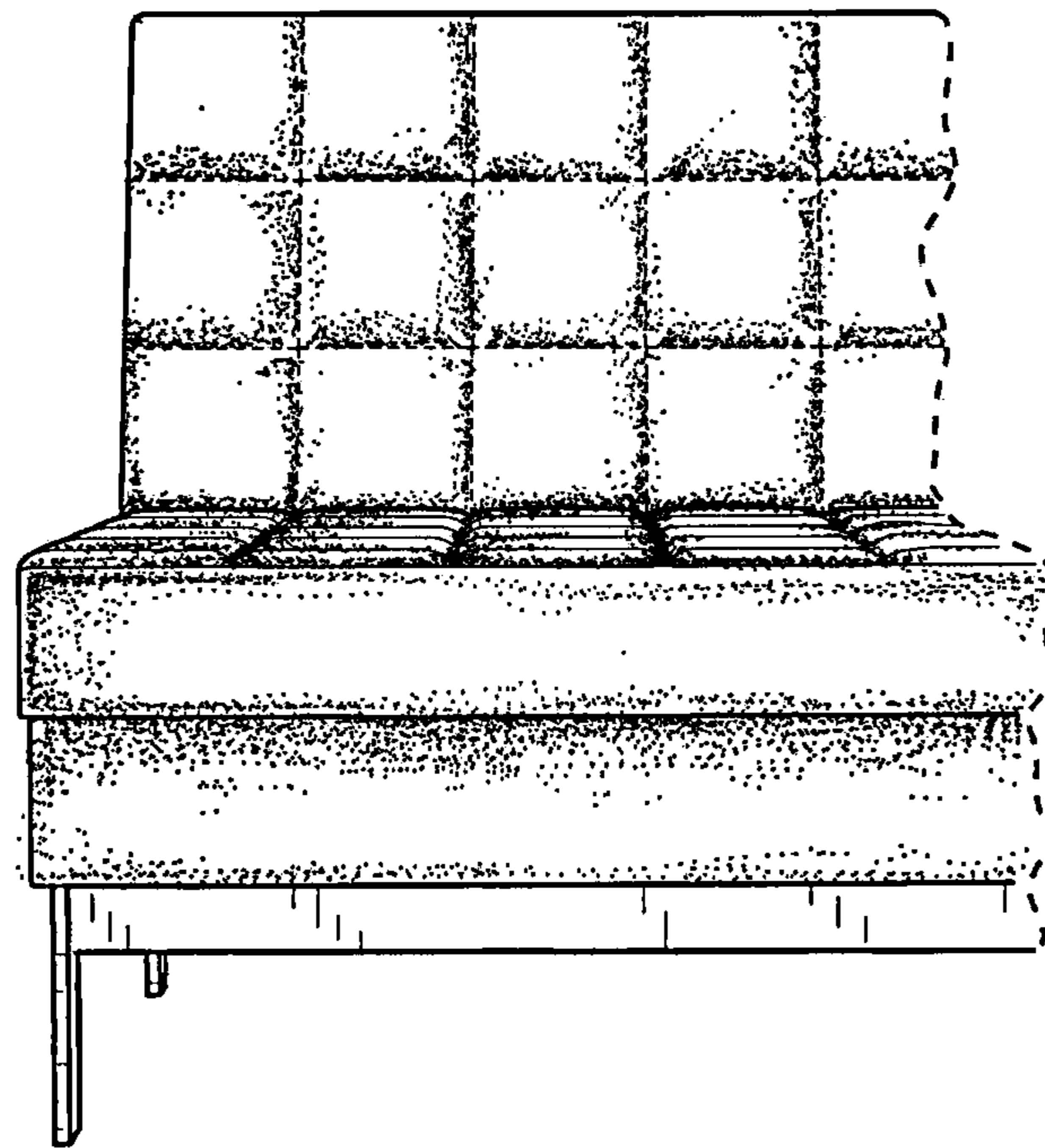

FIG. 3

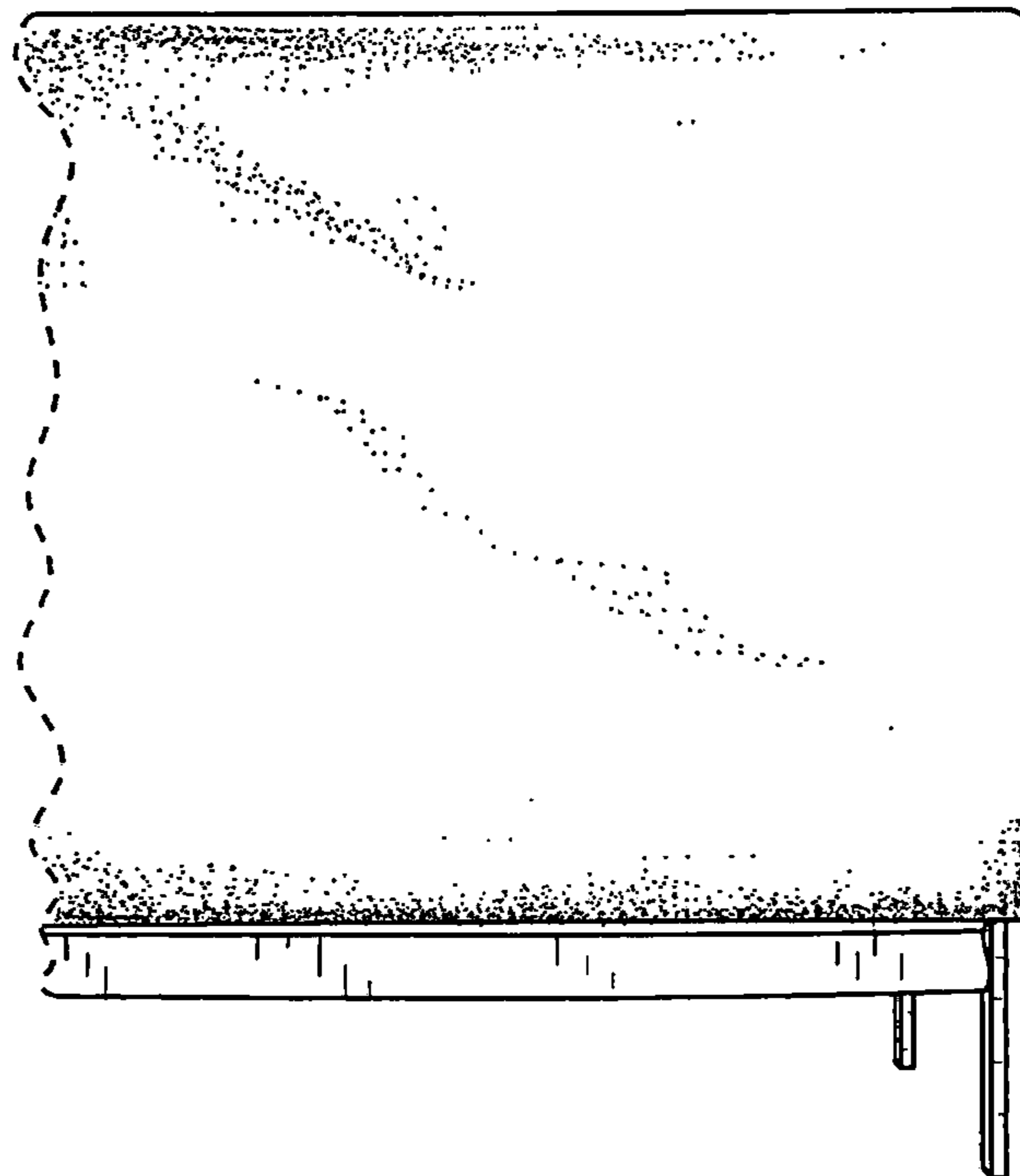

FIG. 4

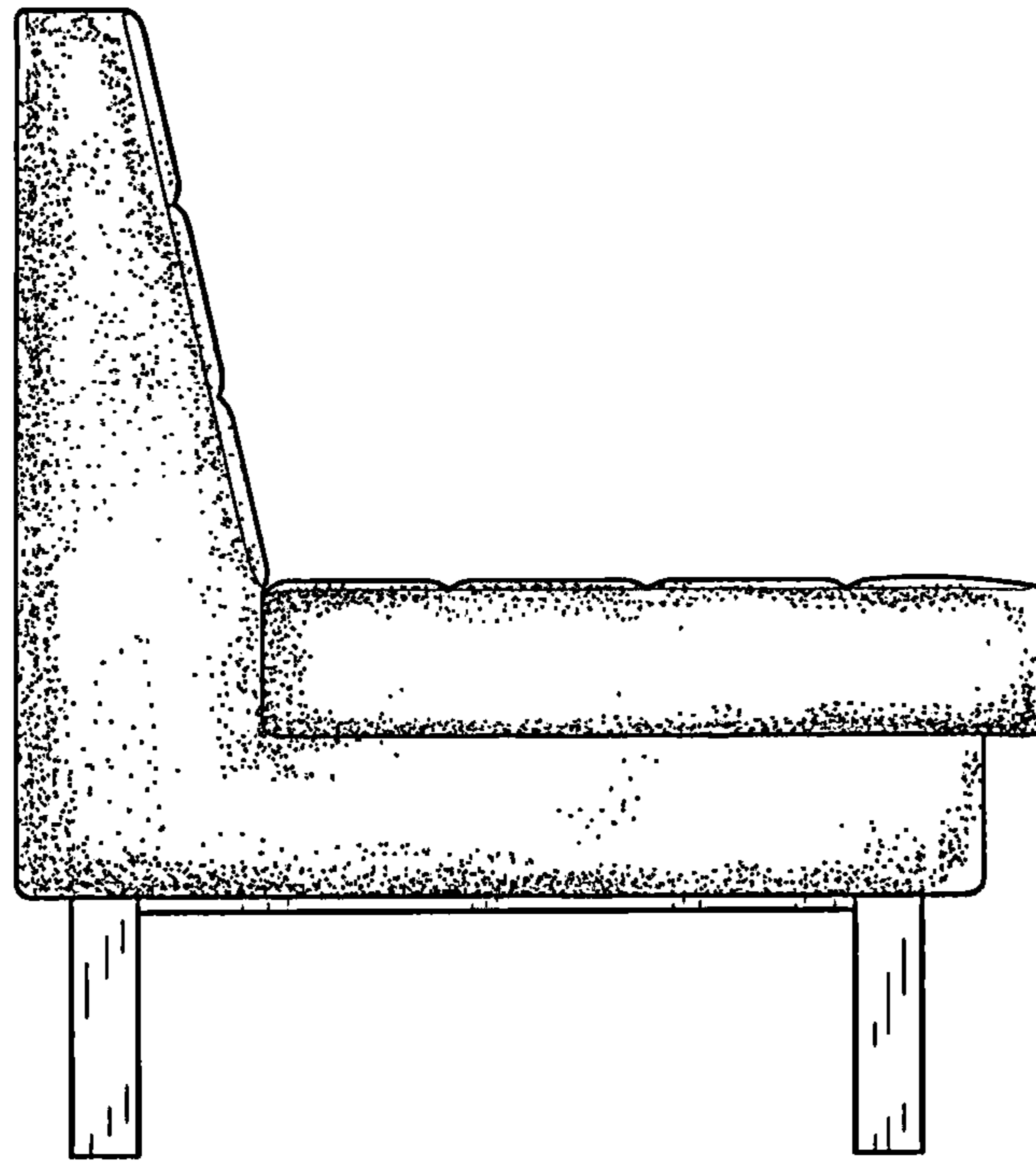

FIG. 5

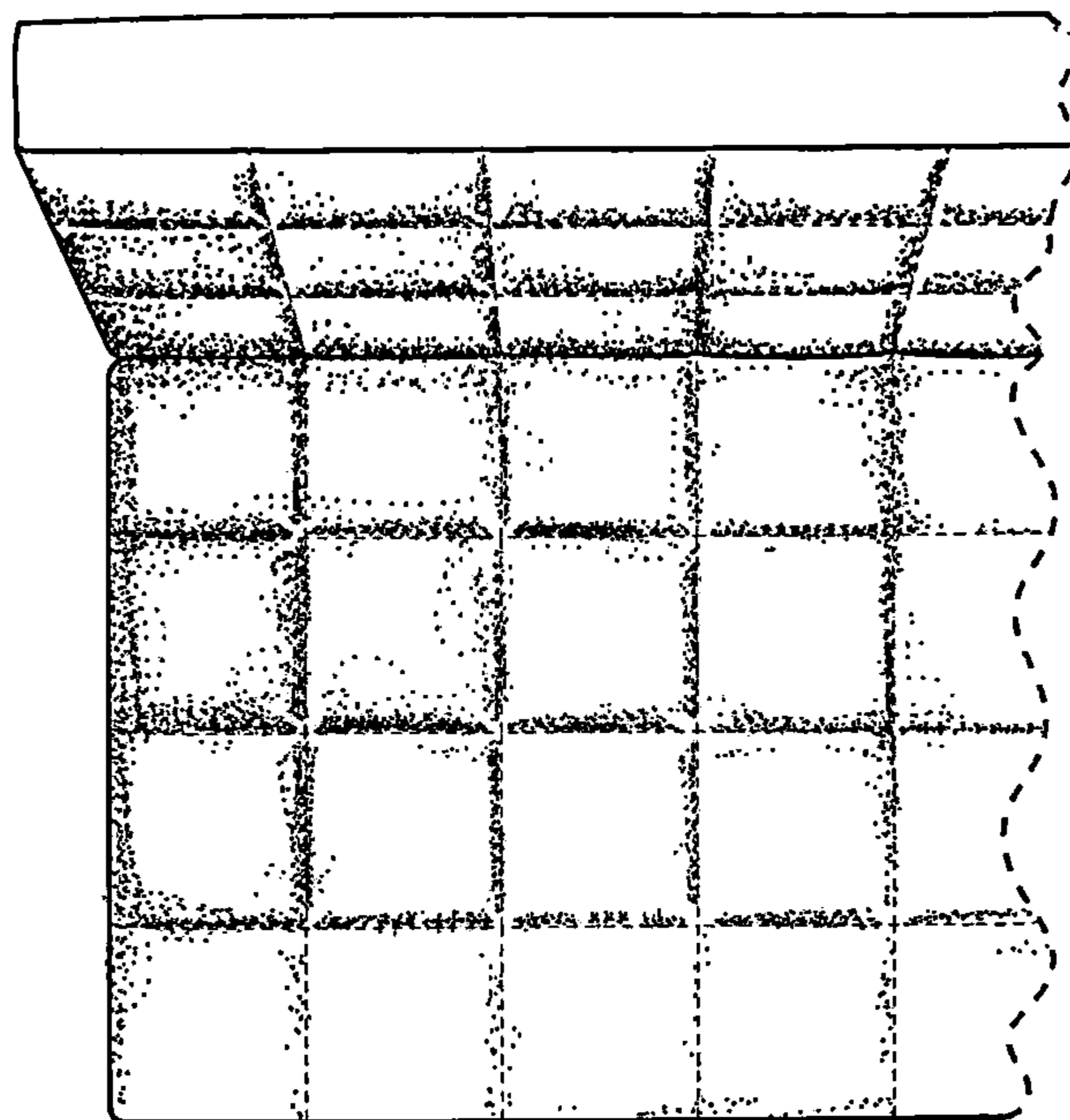

FIG. 6