



US00D685957S

(12) **United States Design Patent**
Schiffman et al.

(10) **Patent No.:** **US D685,957 S**
(45) **Date of Patent:** **** Jul. 9, 2013**

- (54) **ANIMAL LEASH**
- (71) Applicants: **Ellisa Lynn Moorhead Schiffman**,
Vancouver, WA (US); **Crystal Lou Josephsen**, Vancouver, WA (US)
- (72) Inventors: **Ellisa Lynn Moorhead Schiffman**,
Vancouver, WA (US); **Crystal Lou Josephsen**, Vancouver, WA (US)
- (**) Term: **14 Years**
- (21) Appl. No.: **29/445,173**
- (22) Filed: **Feb. 8, 2013**
- (51) **LOC (9) Cl.** **30-04**
- (52) **U.S. Cl.**
USPC **D30/153; D3/226**
- (58) **Field of Classification Search**
USPC D30/144, 145, 146, 151, 152, 153,
D30/199; D2/767, 500, 507, 602, 603, 609,
D2/627, 629, 639; D3/215, 226, 229, 232,
D3/233, 207, 208; 2/129, 131, 133, 141.1,
2/301, 311, 321, 322, 336, 338, 908, 910,
2/911, 912, 916, 919, 920; 119/174, 769,
119/772, 792, 793, 794, 795, 796, 797, 798,
119/815, 850, 855, 856, 858-860, 863-865,
119/907; D11/1-6, 11, 86, 87, 200, 201,
D11/215, 218, 231; 70/459; 224/664, 681;
383/41, 42; 150/127, 143; D6/518
See application file for complete search history.

(56) **References Cited**

U.S. PATENT DOCUMENTS

- 5,441,017 A * 8/1995 Lindsay 119/795
- 5,718,192 A * 2/1998 Sebastian 119/795

- 5,727,500 A * 3/1998 Conboy 119/174
- D393,504 S * 4/1998 Eisman D30/153
- D395,751 S * 7/1998 Dominique D3/233
- D402,624 S * 12/1998 Patterson D12/417
- 6,019,067 A * 2/2000 Carey 119/795
- D425,266 S * 5/2000 Rubinstein D30/153
- 6,073,590 A * 6/2000 Polding 119/795
- 6,085,695 A * 7/2000 Miller et al. 119/795
- 6,240,881 B1 * 6/2001 Edwards et al. 119/795
- 6,418,881 B1 * 7/2002 Starratt 119/795
- D464,179 S * 10/2002 Petersen et al. D6/518
- D492,454 S * 6/2004 Saunders D30/153
- D553,853 S * 10/2007 Willows et al. D3/226
- D576,433 S * 9/2008 Che D6/518
- D653,028 S * 1/2012 Willows et al. D3/226
- 2008/0149235 A1 * 6/2008 Jay 150/143
- 2009/0095225 A1 * 4/2009 O'Connell 119/161
- 2010/0006576 A1 * 1/2010 Berry 220/500

* cited by examiner

Primary Examiner — Caron D Veynar

Assistant Examiner — Martie K Holtje

(74) *Attorney, Agent, or Firm* — Mark S. Hubert

(57) **CLAIM**

The ornamental design for an animal leash, as shown and described.

DESCRIPTION

FIG. 1 is a perspective view of the animal leash showing our new design;
 FIG. 2 is a top view of the animal leash;
 FIG. 3 is a front view of the animal leash;
 FIG. 4 is a left-side view of the animal leash;
 FIG. 5 is a right-side view of the animal leash;
 FIG. 6 is a rear view of the animal leash; and,
 FIG. 7 is a bottom view of the animal leash.

1 Claim, 4 Drawing Sheets

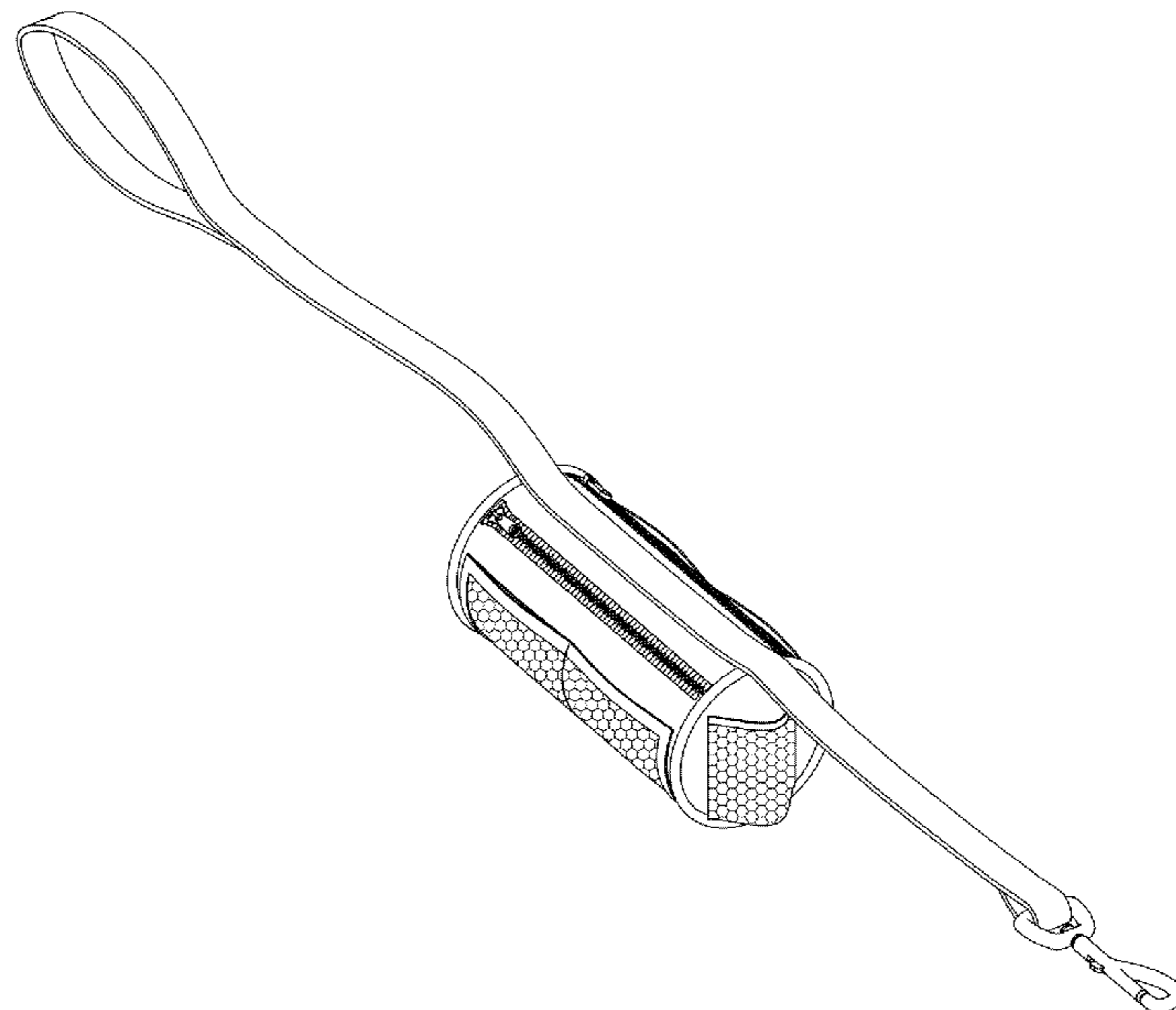

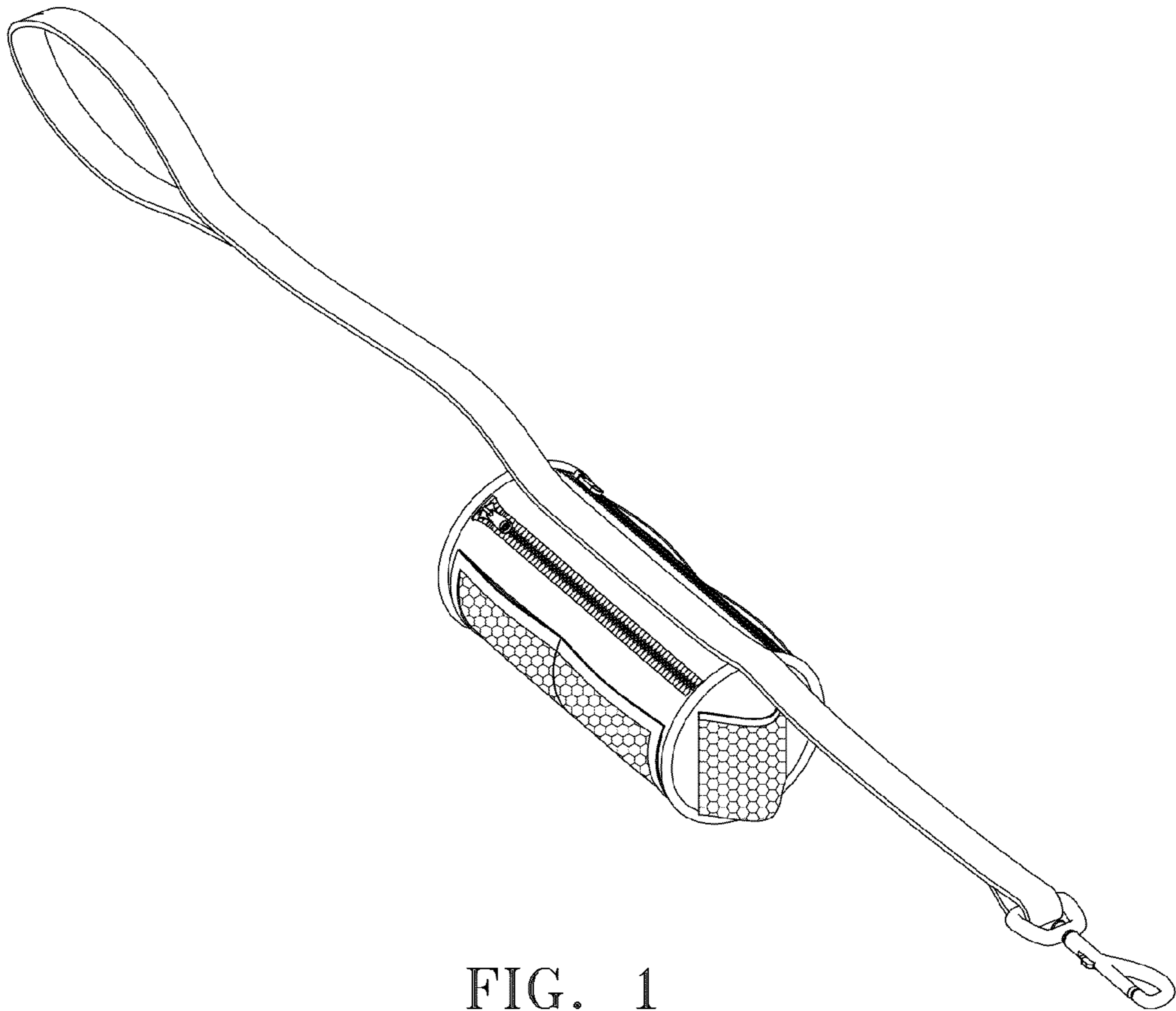

FIG. 1

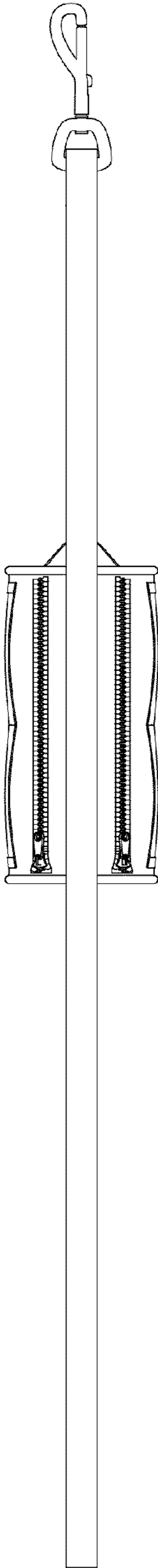

FIG. 2

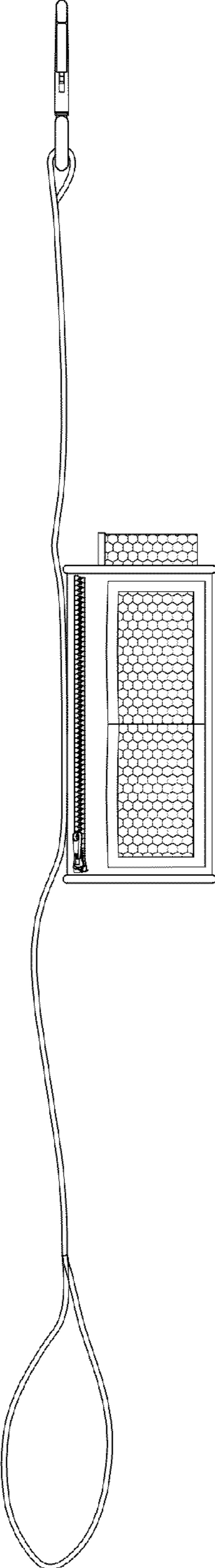

FIG. 3

FIG. 4

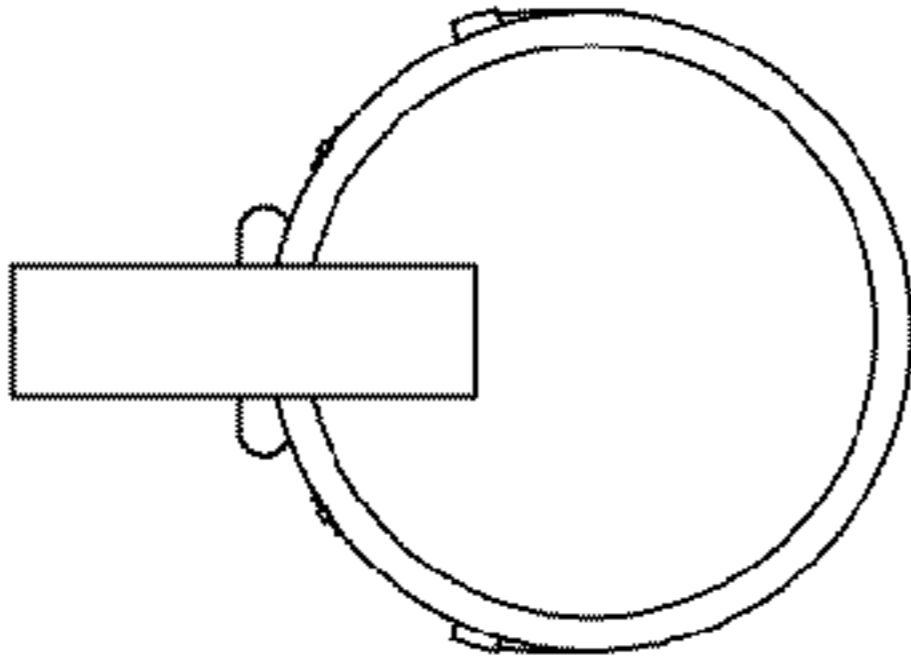

FIG. 5

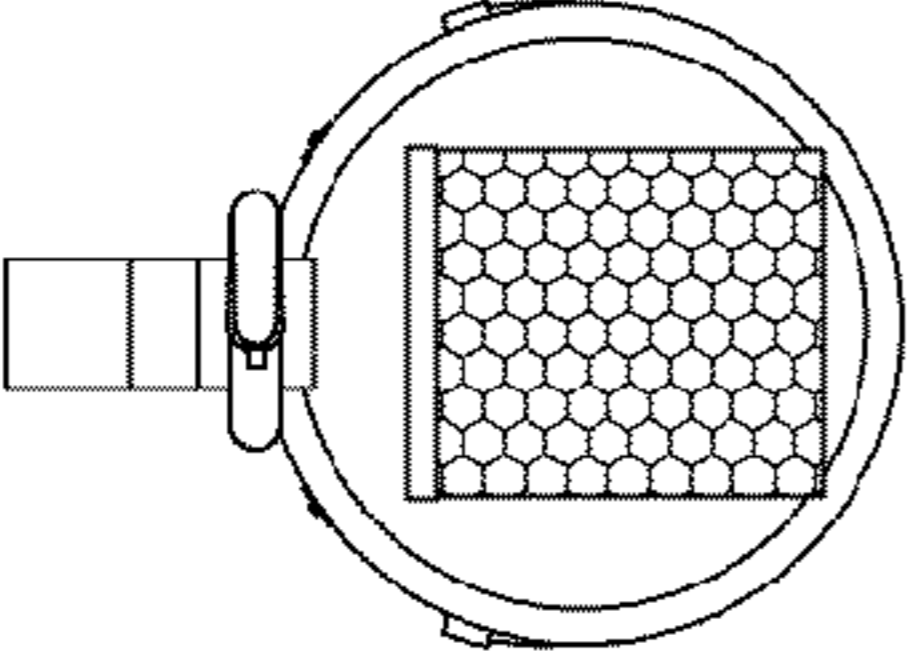
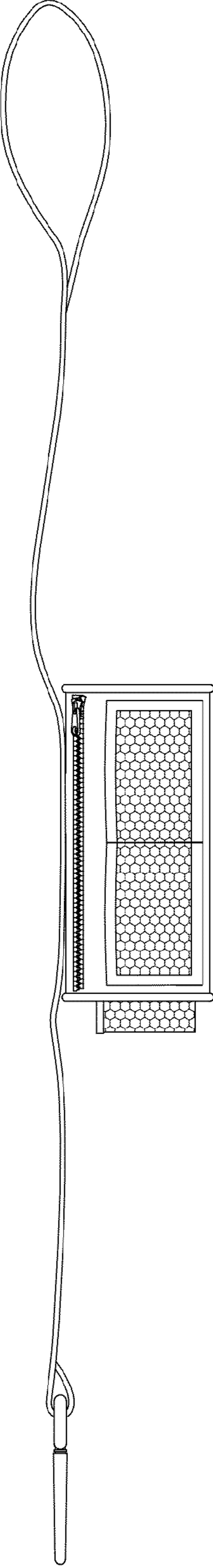

FIG. 6



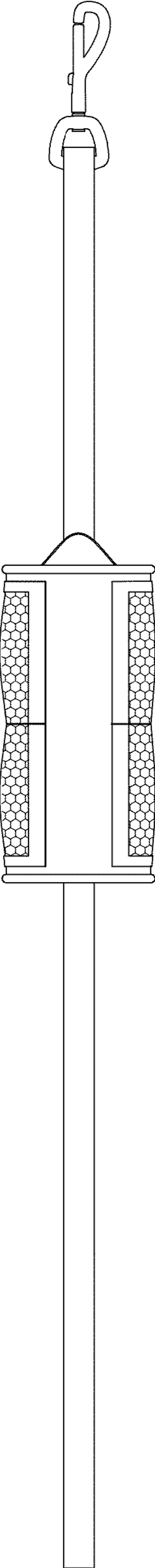

FIG. 7