



US00D685668S

(12) **United States Design Patent**
Guerrero, II

(10) **Patent No.:** **US D685,668 S**

(45) **Date of Patent:** **** Jul. 9, 2013**

(54) **PRESSED COIN PENDANT**

(75) Inventor: **Alberto Guerrero, II**, Coppell, TX (US)

(73) Assignee: **Pennybandz, LLC**, Coppell, TX (US)

(**) Term: **14 Years**

(21) Appl. No.: **29/401,717**

(22) Filed: **Sep. 14, 2011**

(51) **LOC (9) Cl.** **11-01**

(52) **U.S. Cl.**
USPC **D11/79**

(58) **Field of Classification Search**
USPC D11/1, 2, 79-86, 40-45; 63/1.11,
63/18-20

See application file for complete search history.

(56) **References Cited**

U.S. PATENT DOCUMENTS

D250,007 S *	10/1978	Kleiner	D11/79
D263,288 S *	3/1982	Errigo	D11/8
D326,248 S *	5/1992	Horita et al.	D11/221
D388,012 S *	12/1997	Matye	D11/44
D394,021 S *	5/1998	Matye	D11/44
D449,246 S *	10/2001	Carmel	D11/81
D468,986 S *	1/2003	Kan	D11/79
6,835,881 B1 *	12/2004	Jackson	84/322
D575,816 S *	8/2008	Law et al.	D19/10
D606,446 S *	12/2009	Aletto et al.	D11/79
D626,993 S *	11/2010	Law et al.	D19/10
D657,708 S *	4/2012	Guerrero, II	D11/81

* cited by examiner

Primary Examiner — Jennifer Rivard

Assistant Examiner — Melanie Pellegrini

(74) *Attorney, Agent, or Firm* — Fish & Richardson P.C.

(57) **CLAIM**

The ornamental design for a pressed coin pendant, substantially as shown and described.

DESCRIPTION

FIG. 1 is a perspective view of a first embodiment of the pressed coin pendant showing my new design;

FIG. 2 is a front view of the pressed coin pendant of FIG. 1.

FIG. 3 is a back view of the pressed coin pendant of FIG. 1.

FIG. 4 is a side view of the pressed coin pendant of FIG. 1.

FIG. 5 is an opposite side view of the pressed coin pendant of FIG. 1.

FIG. 6 is a top view of the pressed coin pendant of FIG. 1.

FIG. 7 is a bottom view of the pressed coin pendant of FIG. 1.

FIG. 8 is a perspective view of a second embodiment of the pressed coin pendant showing my new design;

FIG. 9 is a front view of the pressed coin pendant of FIG. 8.

FIG. 10 is a back view of the pressed coin pendant of FIG. 8.

FIG. 11 is a side view of the pressed coin pendant of FIG. 8.

FIG. 12 is an opposite side view of the pressed coin pendant of FIG. 8.

FIG. 13 is a top view of the pressed coin pendant of FIG. 8;

and,

FIG. 14 is a bottom view of the pressed coin pendant of FIG. 8.

The broken lines shown in the drawings represent portions of the pressed coin pendant and form no part of the claimed design.

1 Claim, 4 Drawing Sheets

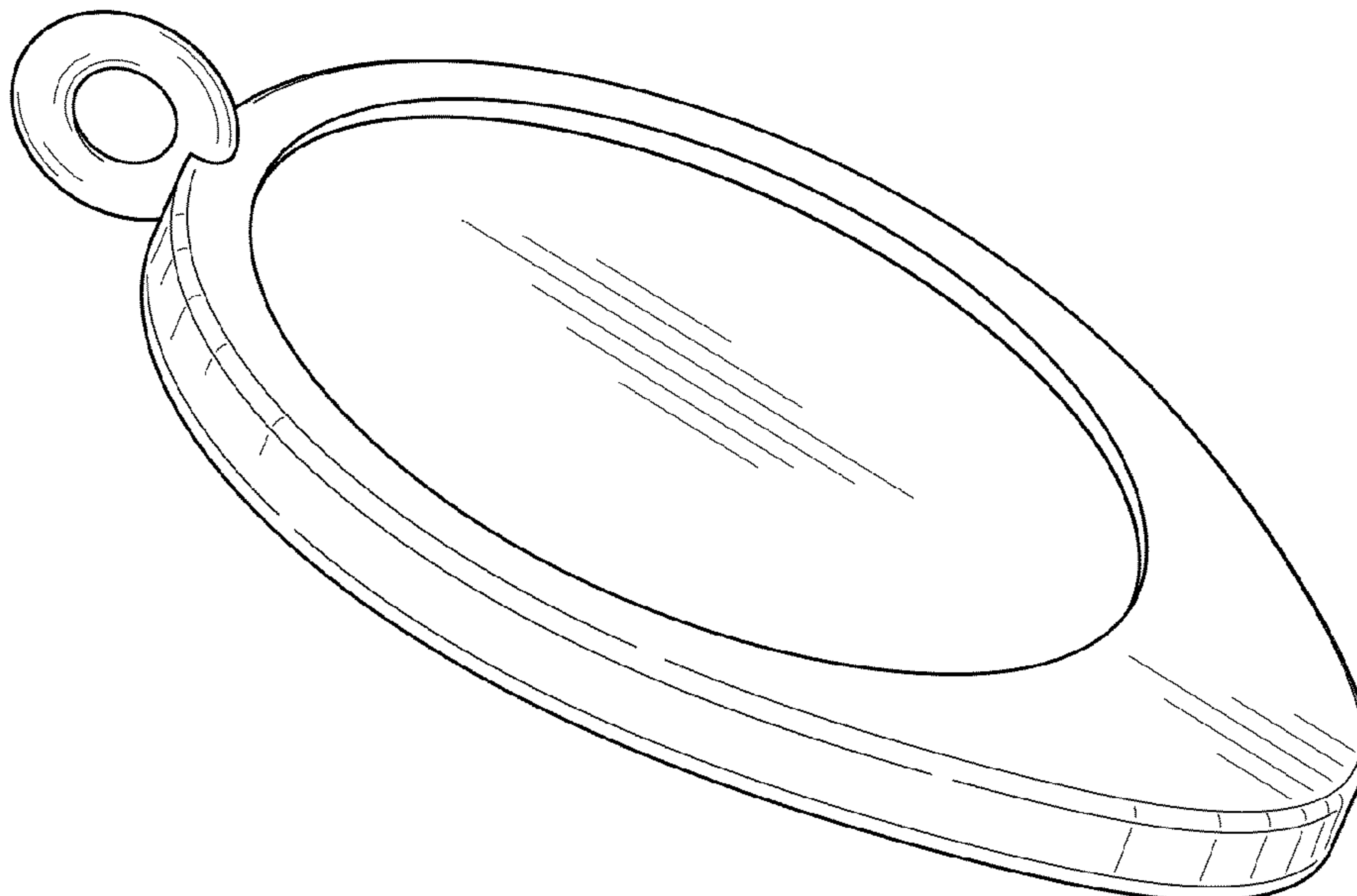

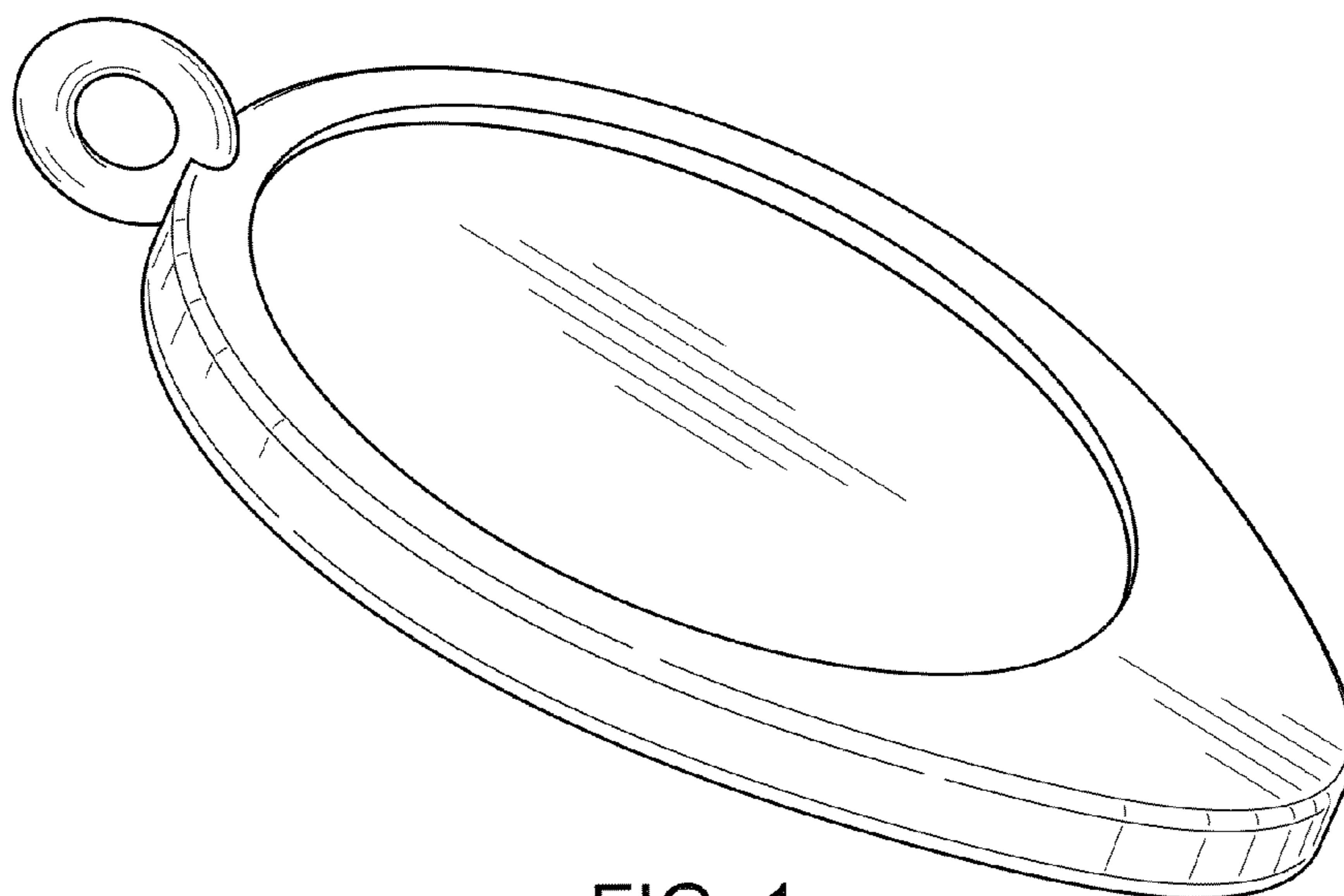

FIG. 1

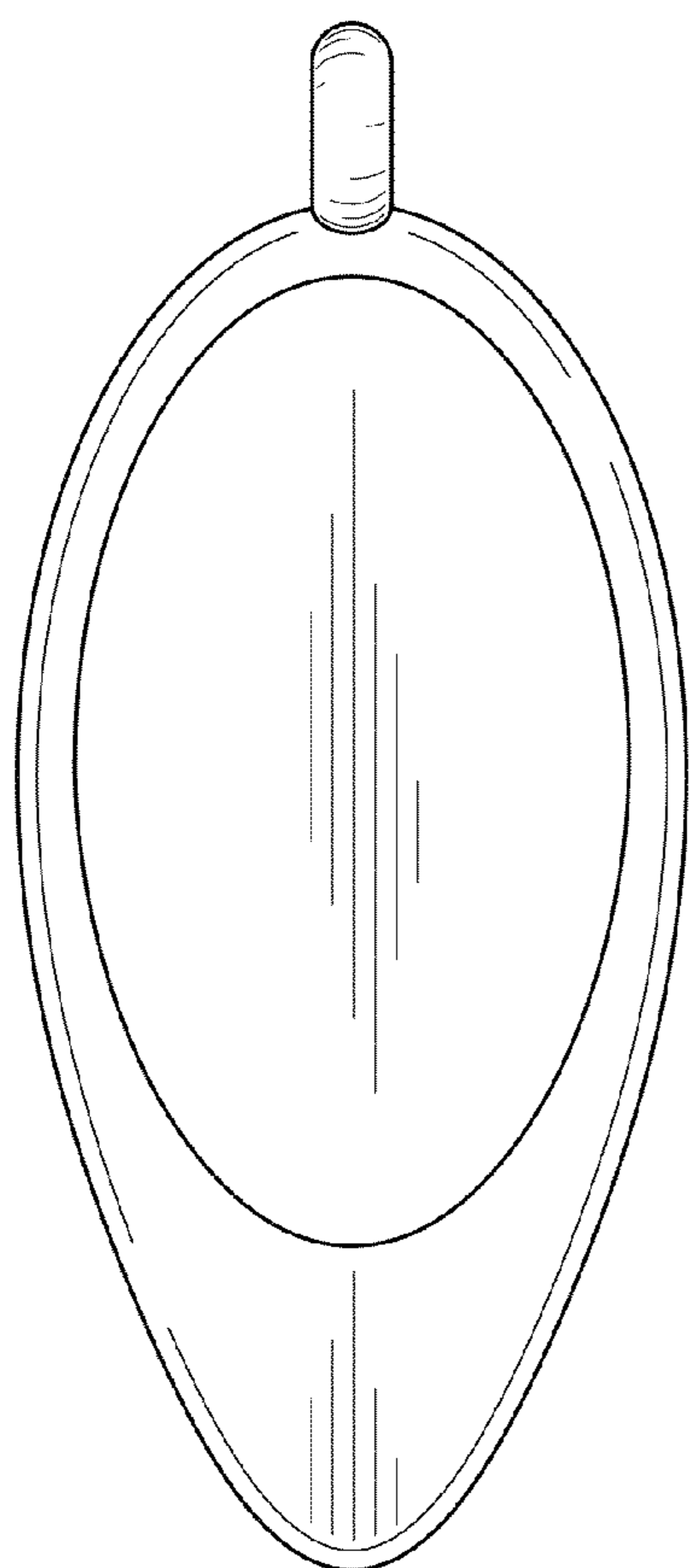

FIG. 2

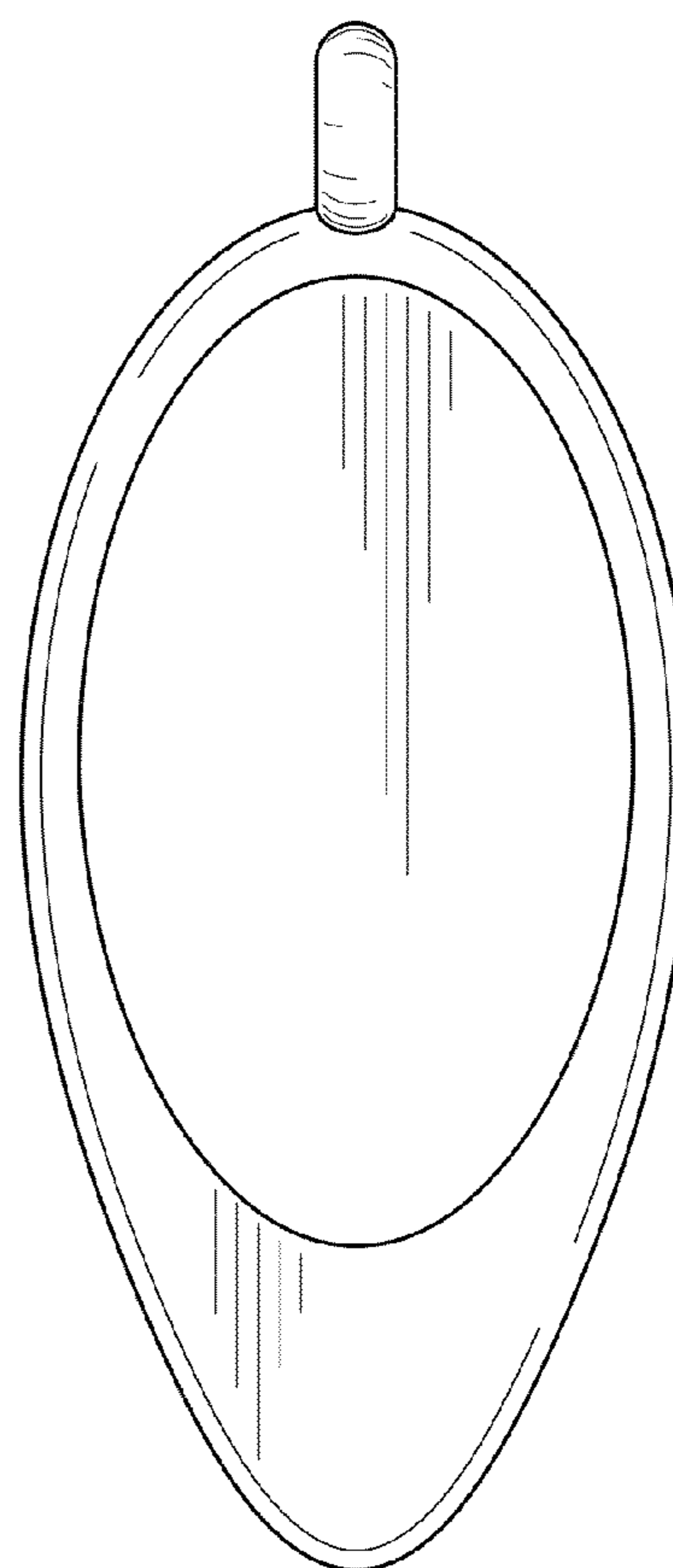

FIG. 3

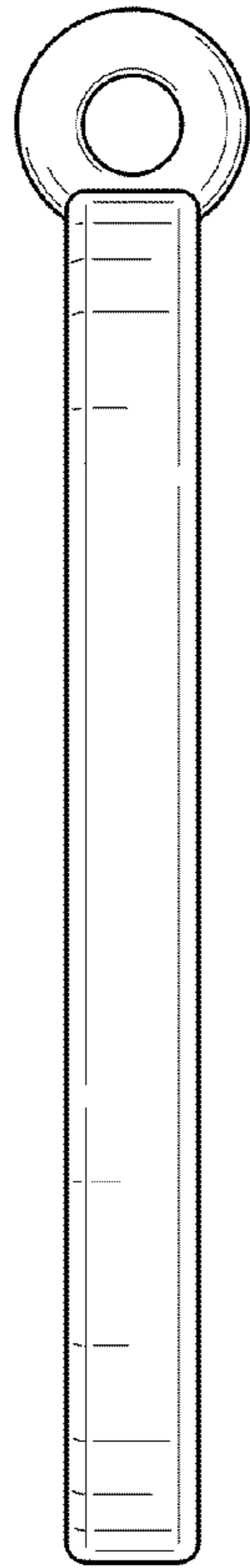

FIG. 4

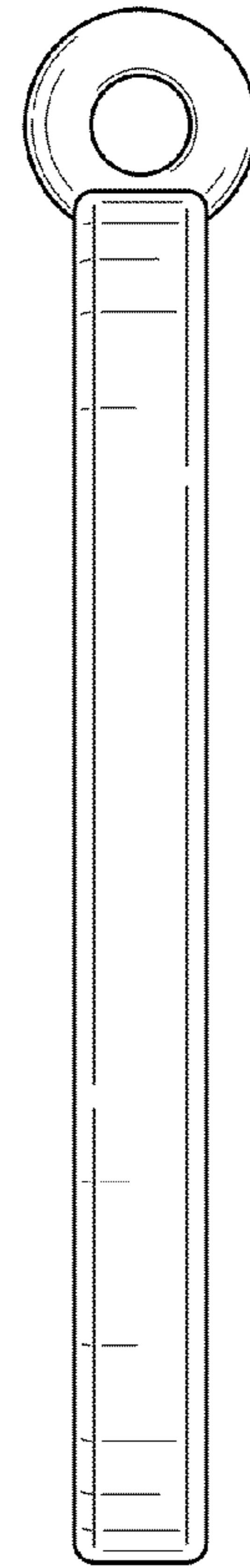

FIG. 5

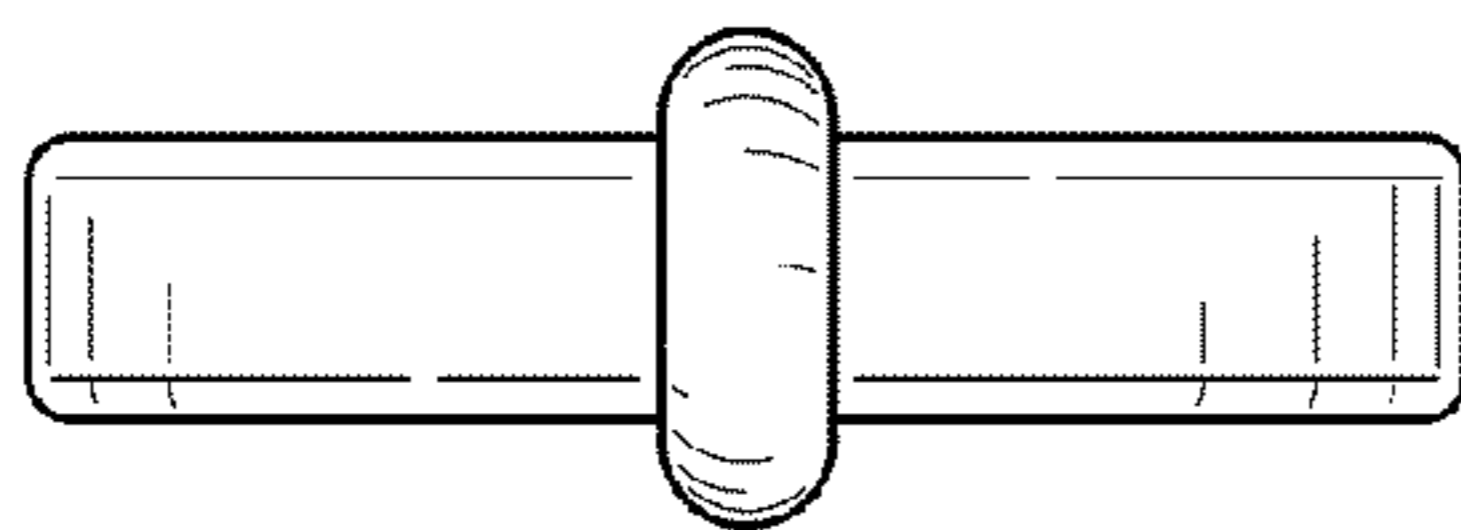

FIG. 6

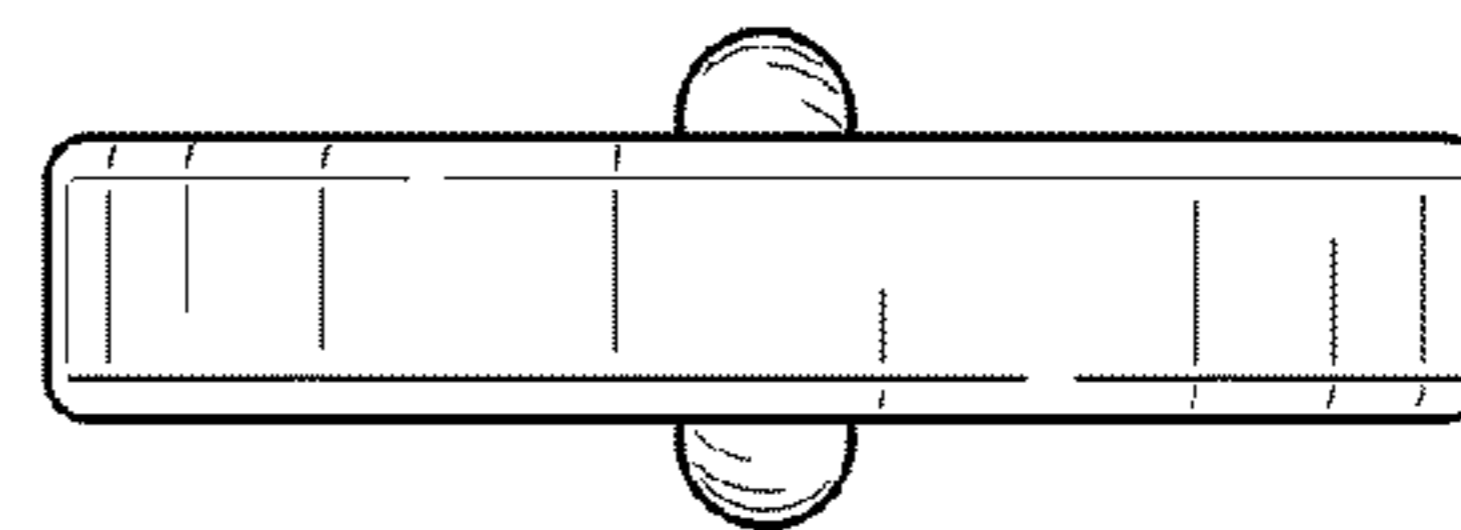

FIG. 7

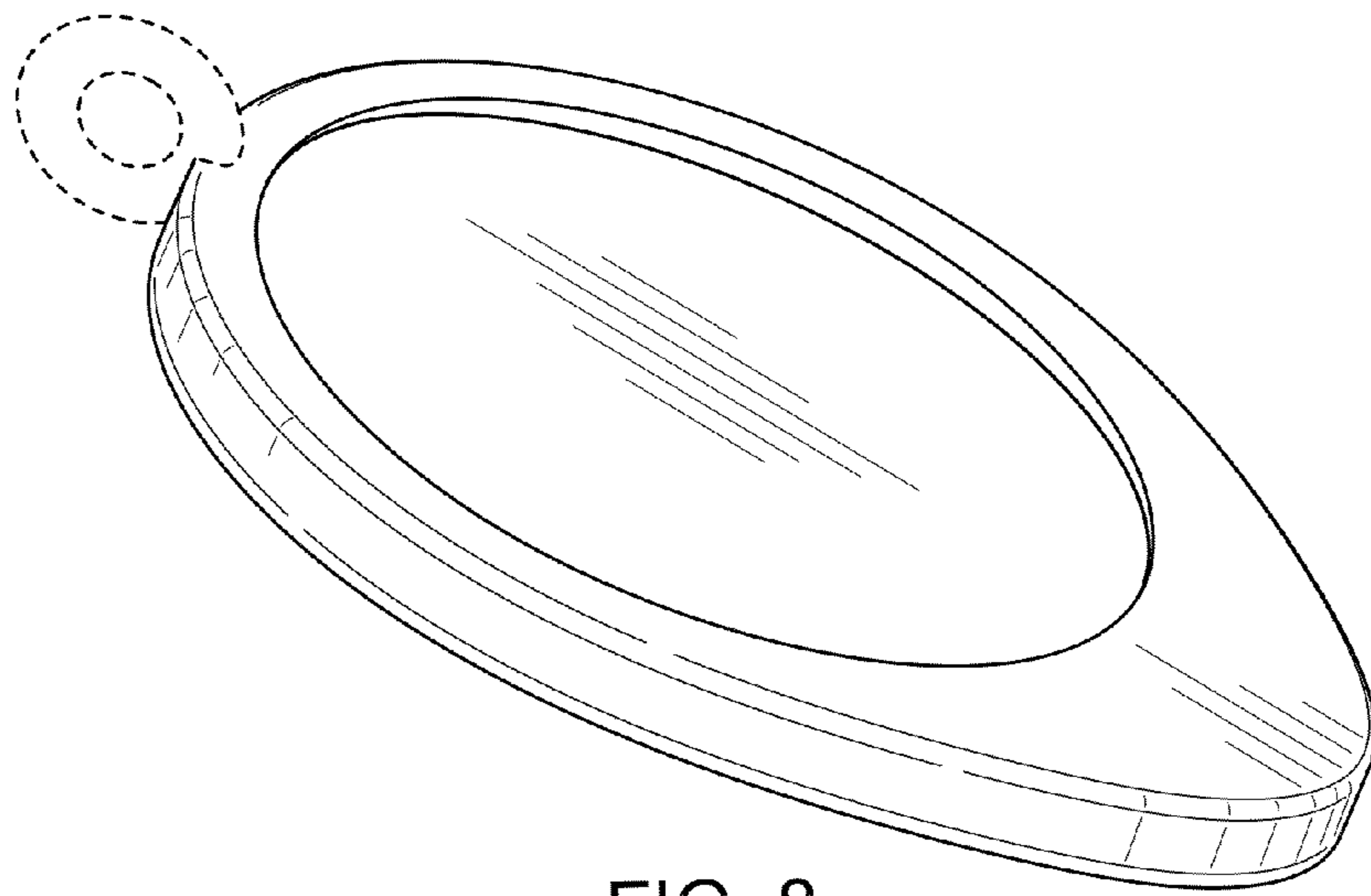

FIG. 8

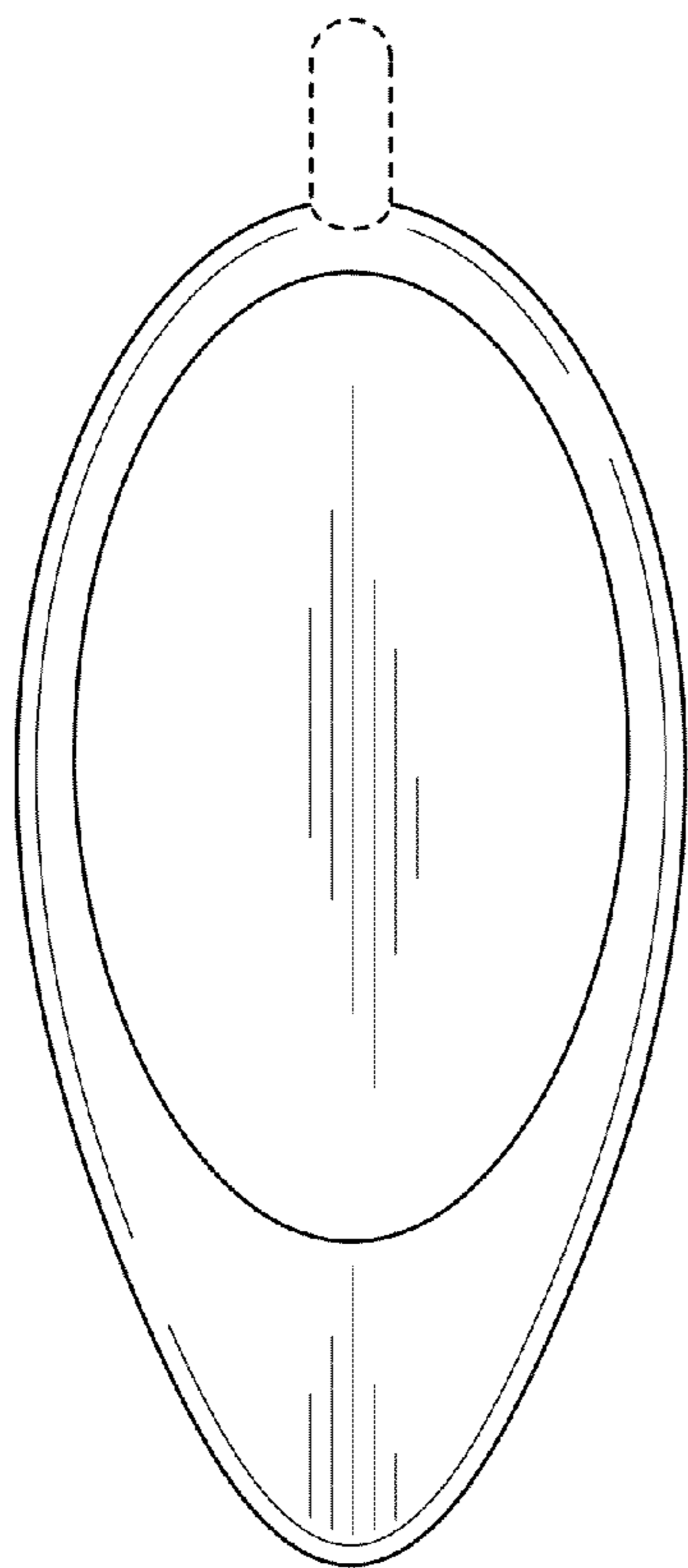

FIG. 9

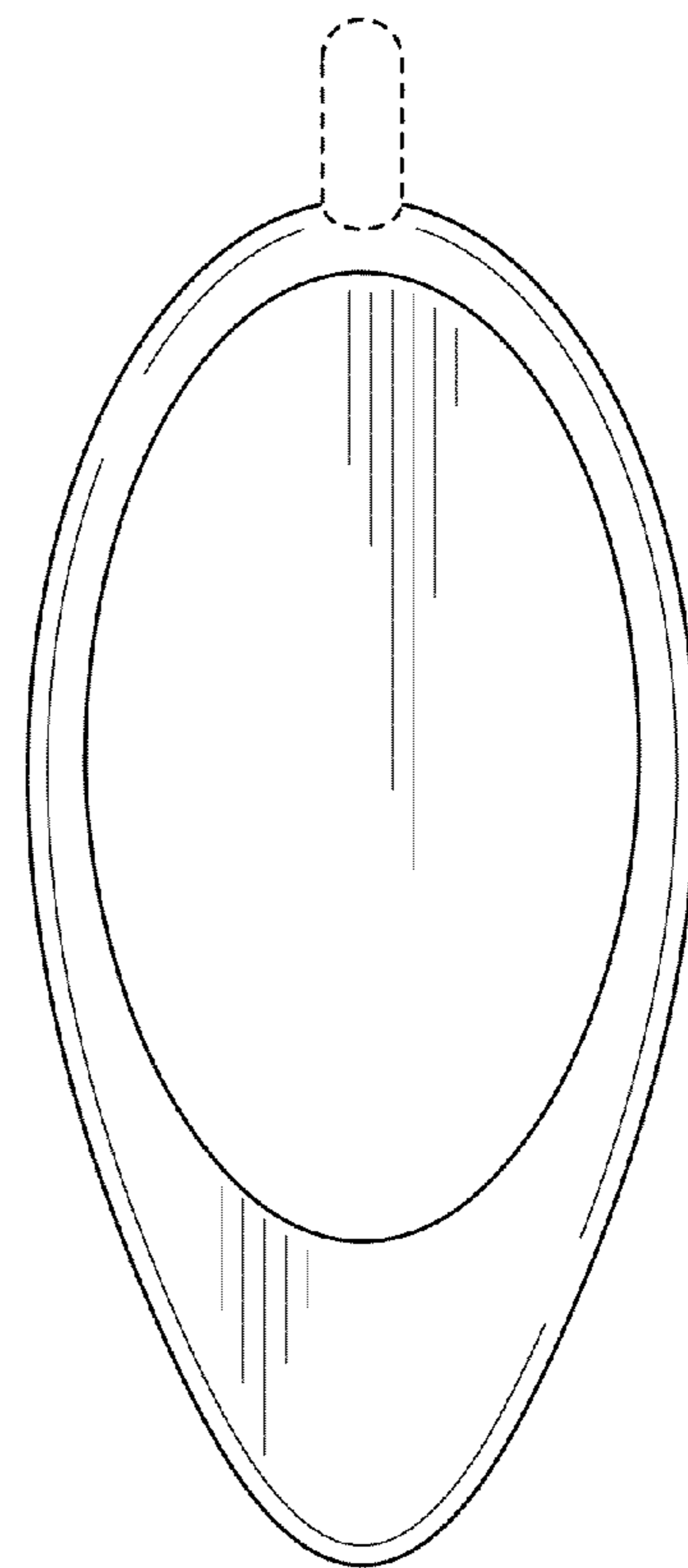

FIG. 10

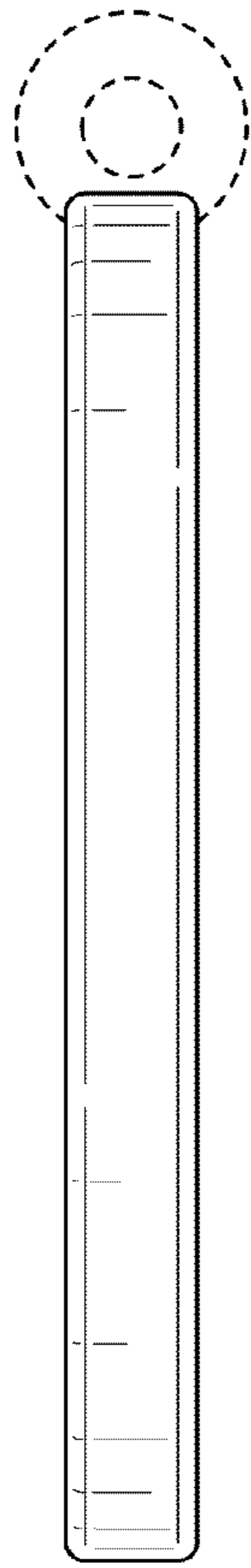

FIG. 11

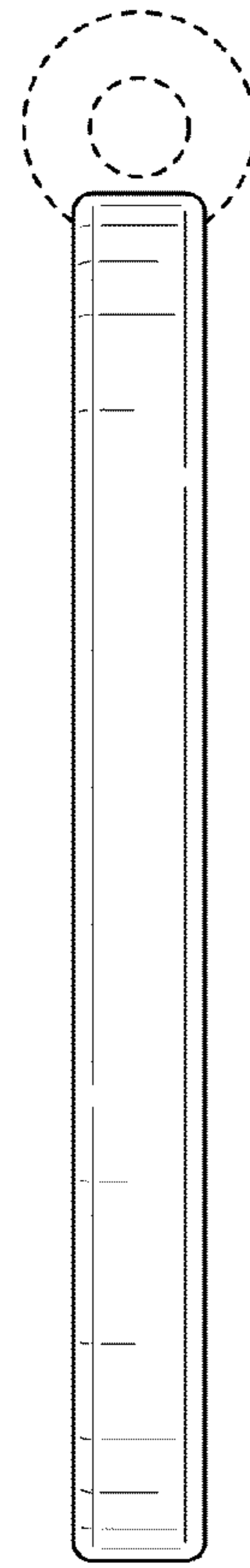

FIG. 12

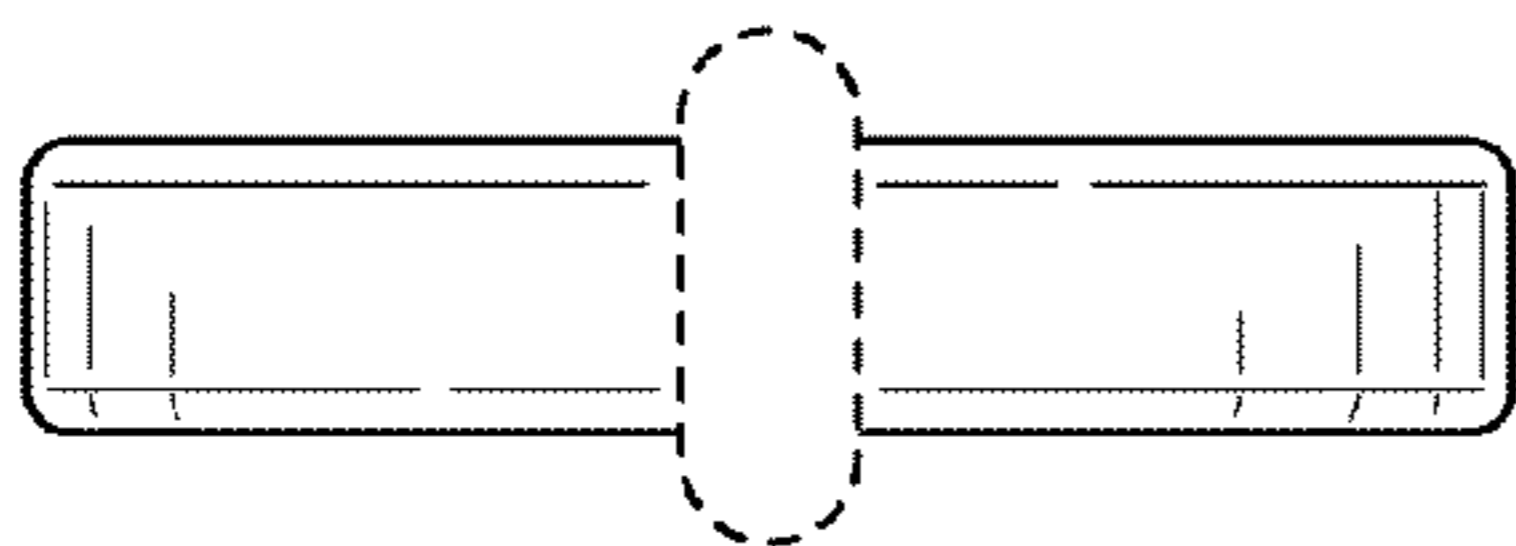

FIG. 13

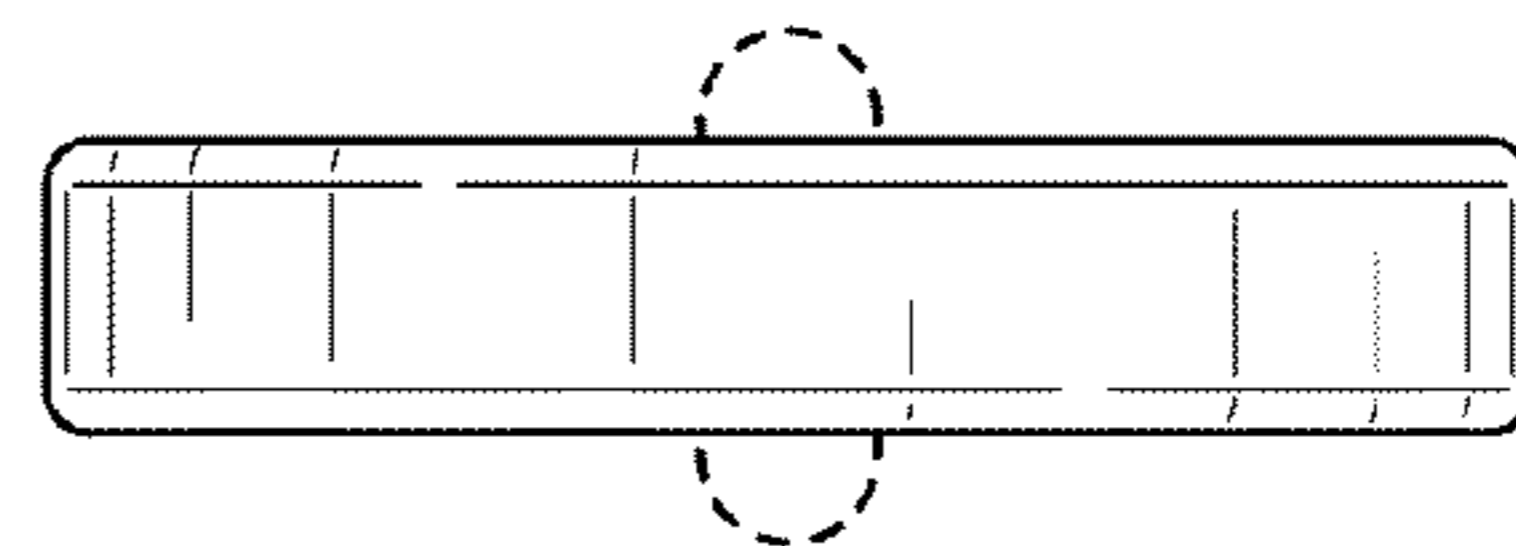

FIG. 14