

US00D685667S

(12) **United States Design Patent**  
**Papadimitriou**

(10) **Patent No.:** **US D685,667 S**

(45) **Date of Patent:** **\*\* Jul. 9, 2013**

(54) **JEWELRY ARTICLE**

(71) Applicant: **De Beers Centenary AG**, Lucerne (CH)

(72) Inventor: **Costantino Papadimitriou**, Milan (IT)

(73) Assignee: **De Beers Centenary AG**, Lucerne (CH)

(\*\*) Term: **14 Years**

(21) Appl. No.: **29/443,347**

(22) Filed: **Jan. 16, 2013**

**Related U.S. Application Data**

(62) Division of application No. 29/420,743, filed on May 11, 2012, now Pat. No. Des. 676,780.

(51) **LOC (9) Cl.** ..... **11-01**

(52) **U.S. Cl.**  
USPC ..... **D11/43; D11/79**

(58) **Field of Classification Search**  
USPC ... D11/79-85, 89-91, 40-48, 1-8; 63/26-28,  
63/12-14, 3, 3.1, 3.2  
See application file for complete search history.

(56) **References Cited**

**U.S. PATENT DOCUMENTS**

D42,514 S *	5/1912	Myers	.....	D11/90
D257,026 S *	9/1980	Barr	.....	D11/75
D279,878 S *	7/1985	Moon	.....	D11/43
D335,471 S *	5/1993	Coleman	.....	D11/79
D386,439 S *	11/1997	Itzkowitz	.....	D11/41
D394,824 S *	6/1998	Itzkowitz	.....	D11/79
D485,779 S *	1/2004	Steckbeck	.....	D11/7
D602,807 S *	10/2009	Colombani et al.	.....	D11/92
D628,113 S *	11/2010	Papadimitriou	.....	D11/40
D630,967 S *	1/2011	Lebail	.....	D11/43
D631,384 S *	1/2011	Papadimitriou	.....	D11/43
D634,667 S *	3/2011	Papadimitriou	.....	D11/79
D635,047 S *	3/2011	Papadimitriou	.....	D11/43
D643,325 S *	8/2011	Marchand	.....	D11/79
D658,530 S *	5/2012	Papadimitriou	.....	D11/43

\* cited by examiner

*Primary Examiner* — Cathron Brooks

*Assistant Examiner* — Melanie Pellegrini

(74) *Attorney, Agent, or Firm* — Dentons US LLP; Brian R. McGinley

(57) **CLAIM**

The ornamental design for a jewelry article, as shown and described.

**DESCRIPTION**

FIG. 1 is a top view of a first embodiment of the jewelry article;

FIG. 2 is a bottom view of the jewelry article illustrated in FIG. 1;

FIG. 3 is a right elevational view of the jewelry article illustrated in FIG. 1;

FIG. 4 is a left elevational view of the jewelry article illustrated in FIG. 1;

FIG. 5 is a front view of the jewelry article illustrated in FIG. 1;

FIG. 6 is a rear view of the jewelry article illustrated in FIG. 1;

FIG. 7 is a perspective view of the jewelry article illustrated in FIG. 1;

FIG. 8 is a top view of a second embodiment of the jewelry article;

FIG. 9 is a bottom view of the jewelry article illustrated in FIG. 8;

FIG. 10 is a right elevational view of the jewelry article illustrated in FIG. 8;

FIG. 11 is a left elevational view of the jewelry article illustrated in FIG. 8;

FIG. 12 is a front view of the jewelry article illustrated in FIG. 8;

FIG. 13 is a rear view of the jewelry article illustrated in FIG. 8; and,

FIG. 14 is a perspective view of the jewelry article illustrated in FIG. 8.

**1 Claim, 8 Drawing Sheets**

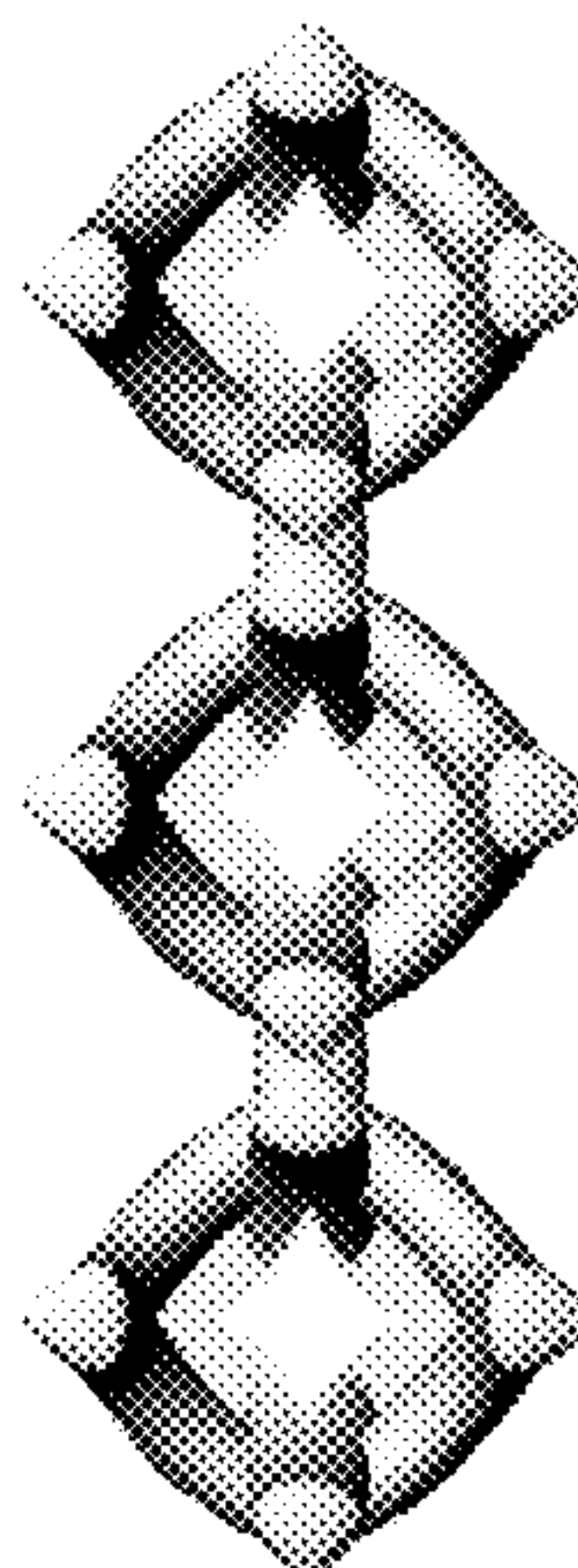

FIG. 1

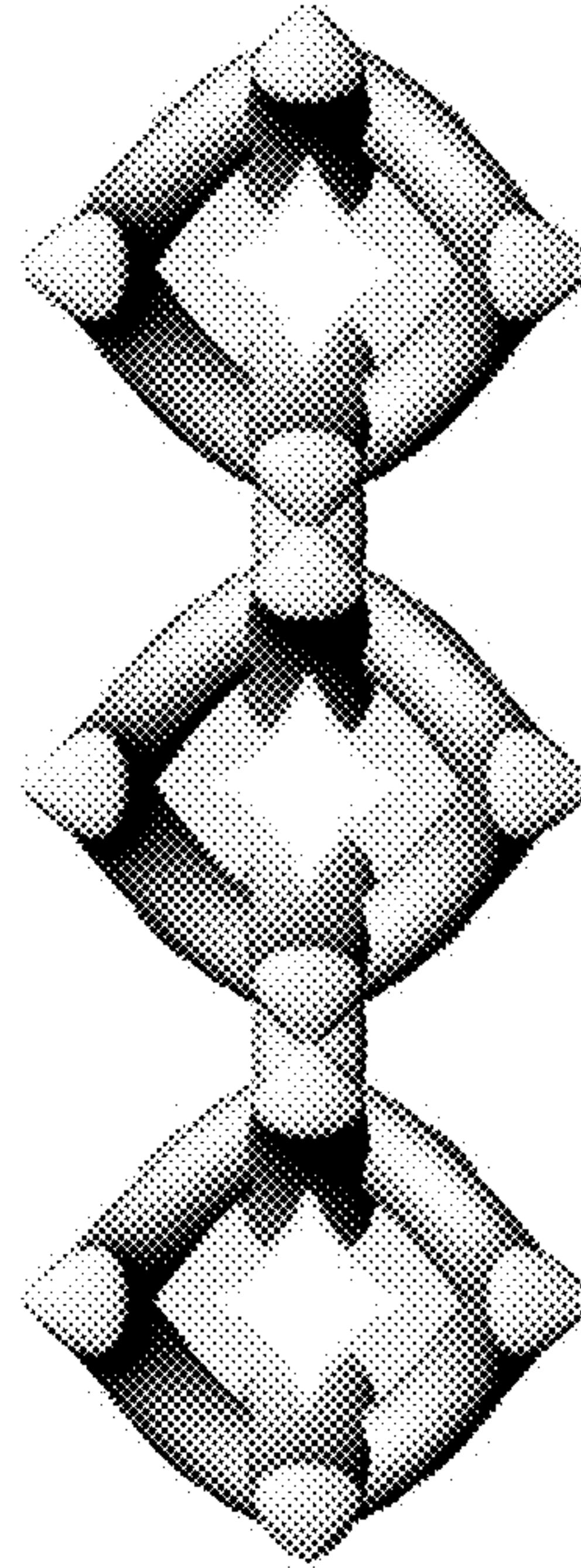

FIG. 2

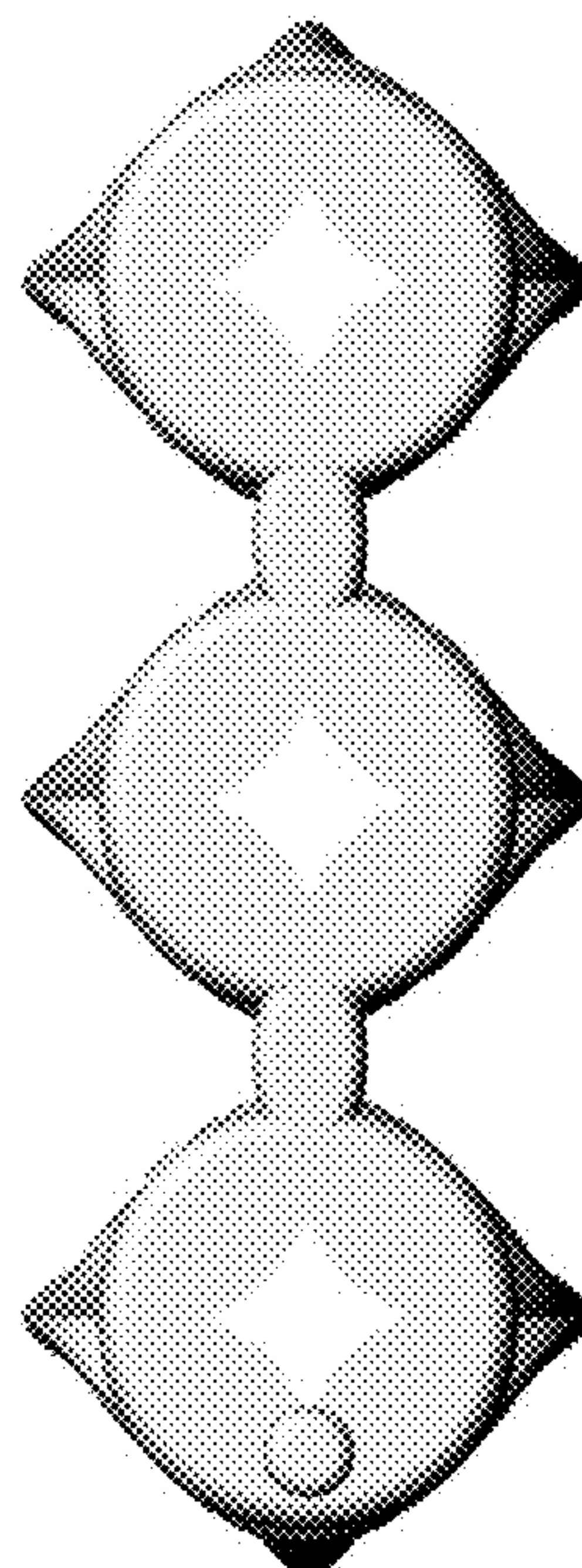



FIG. 3

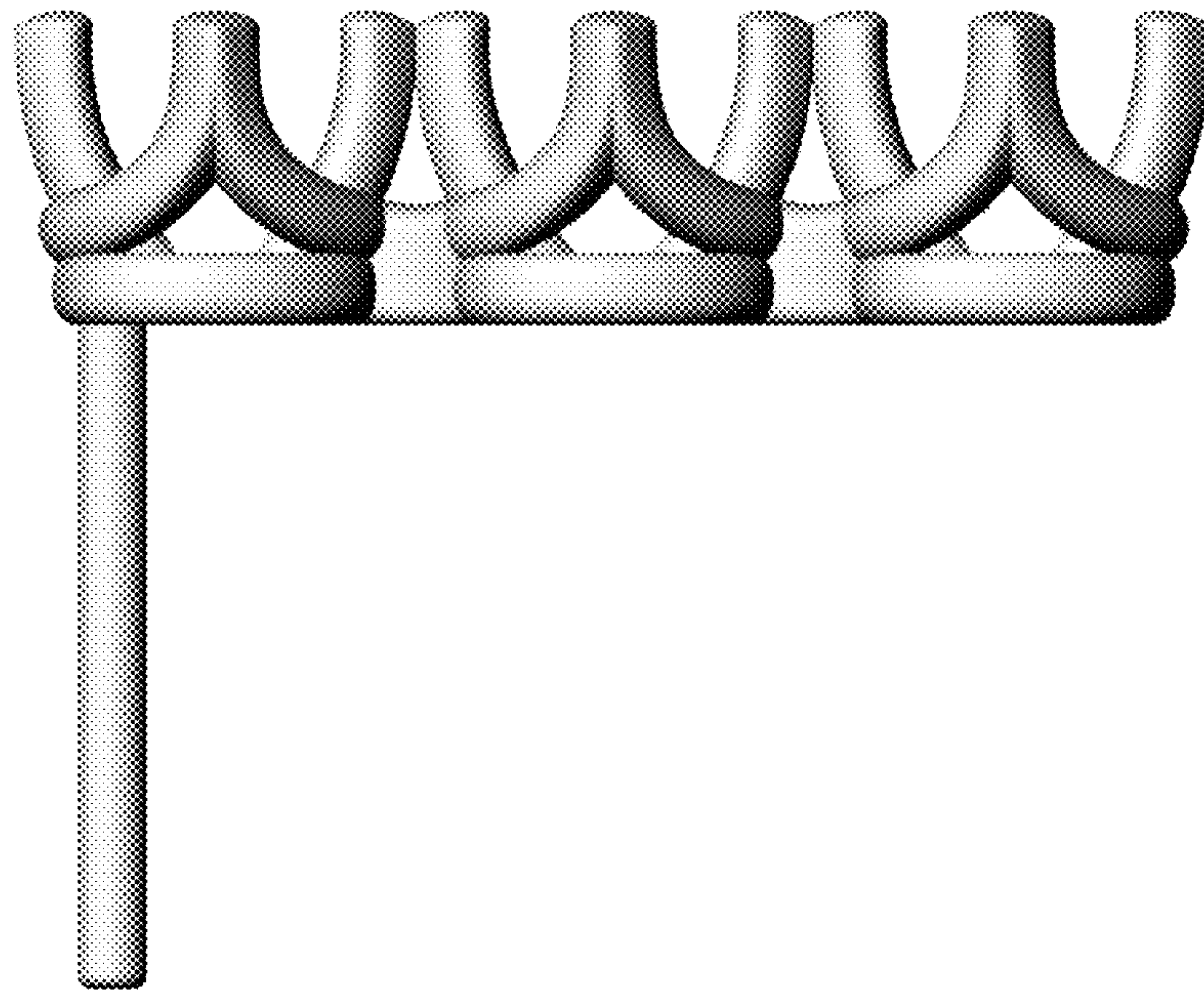

FIG. 4

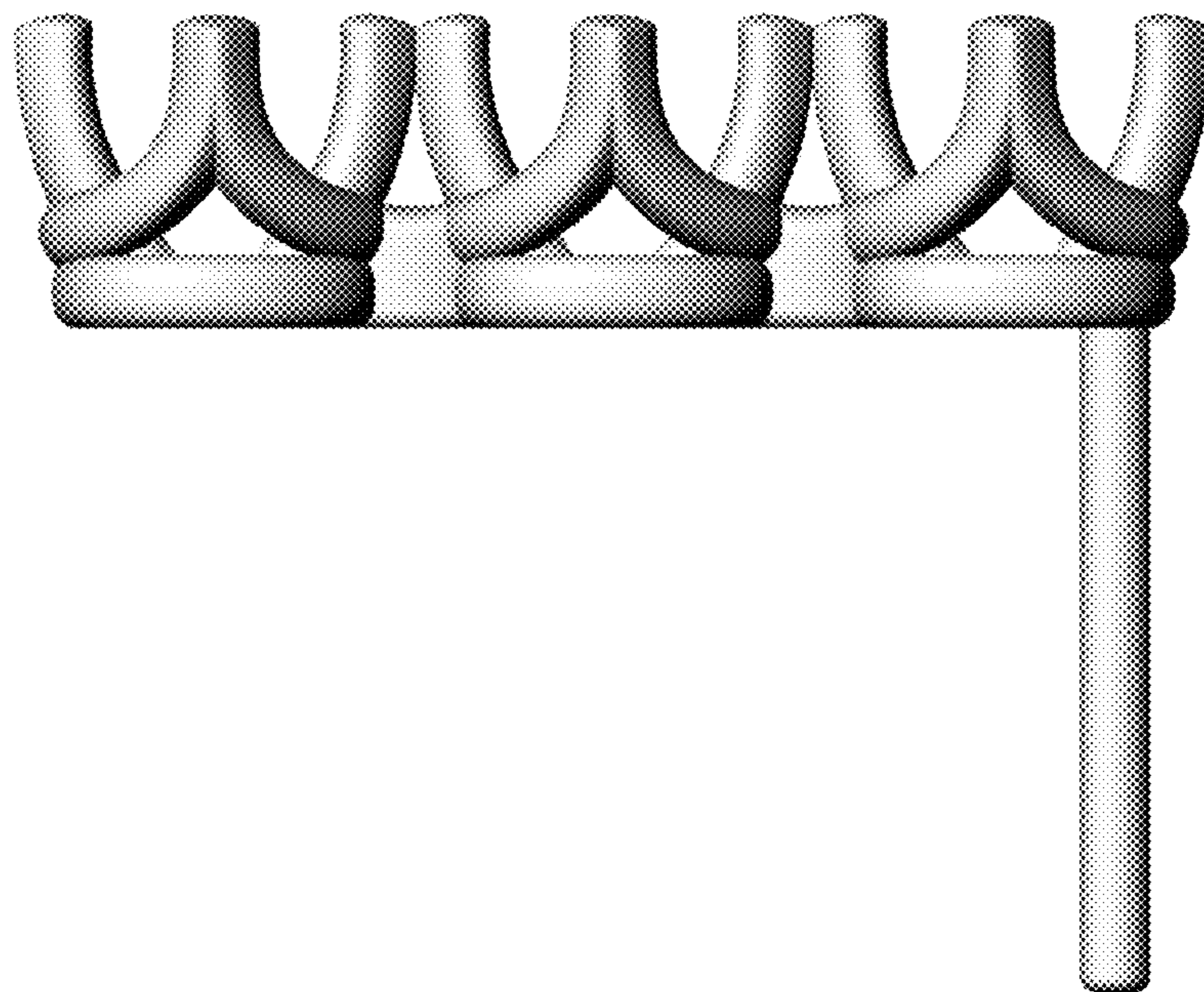

FIG. 5

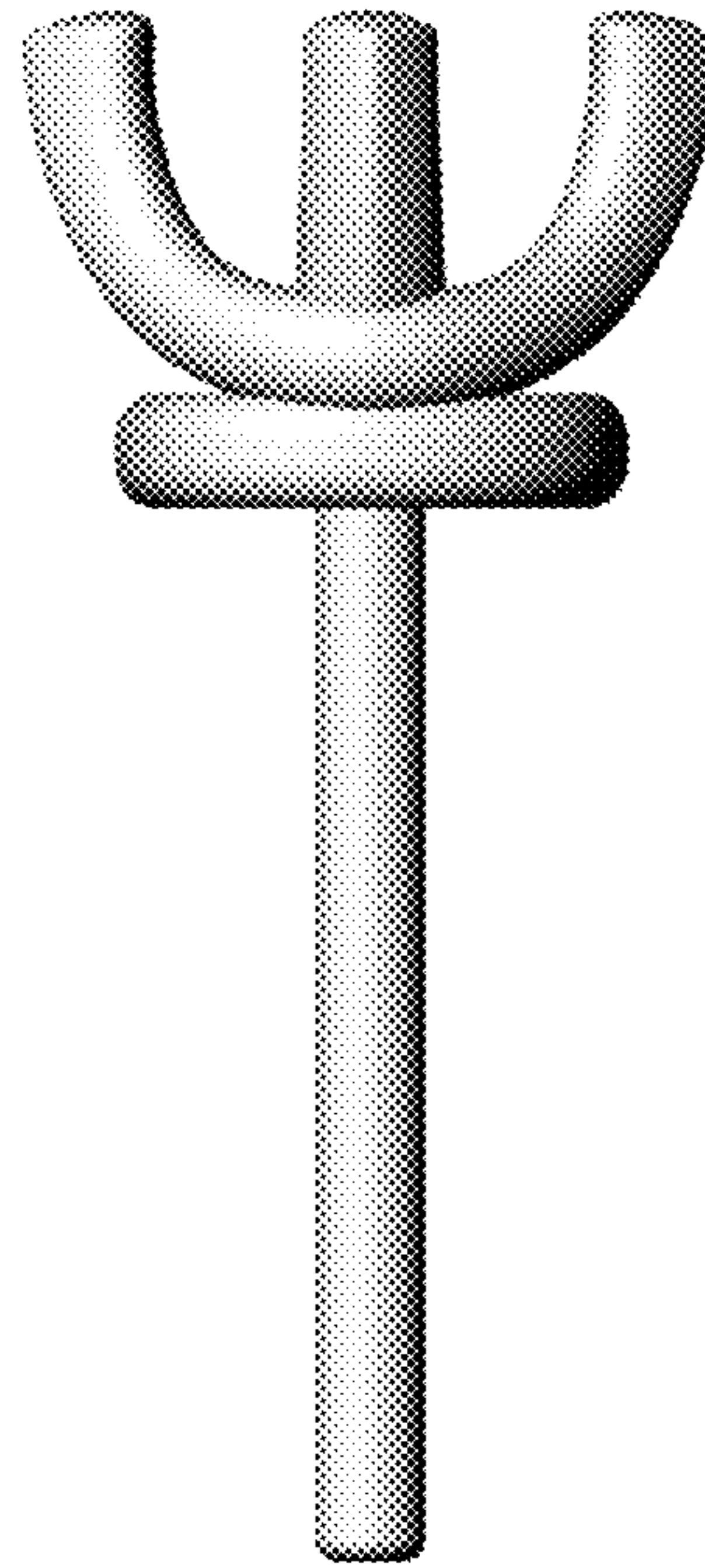

FIG. 6

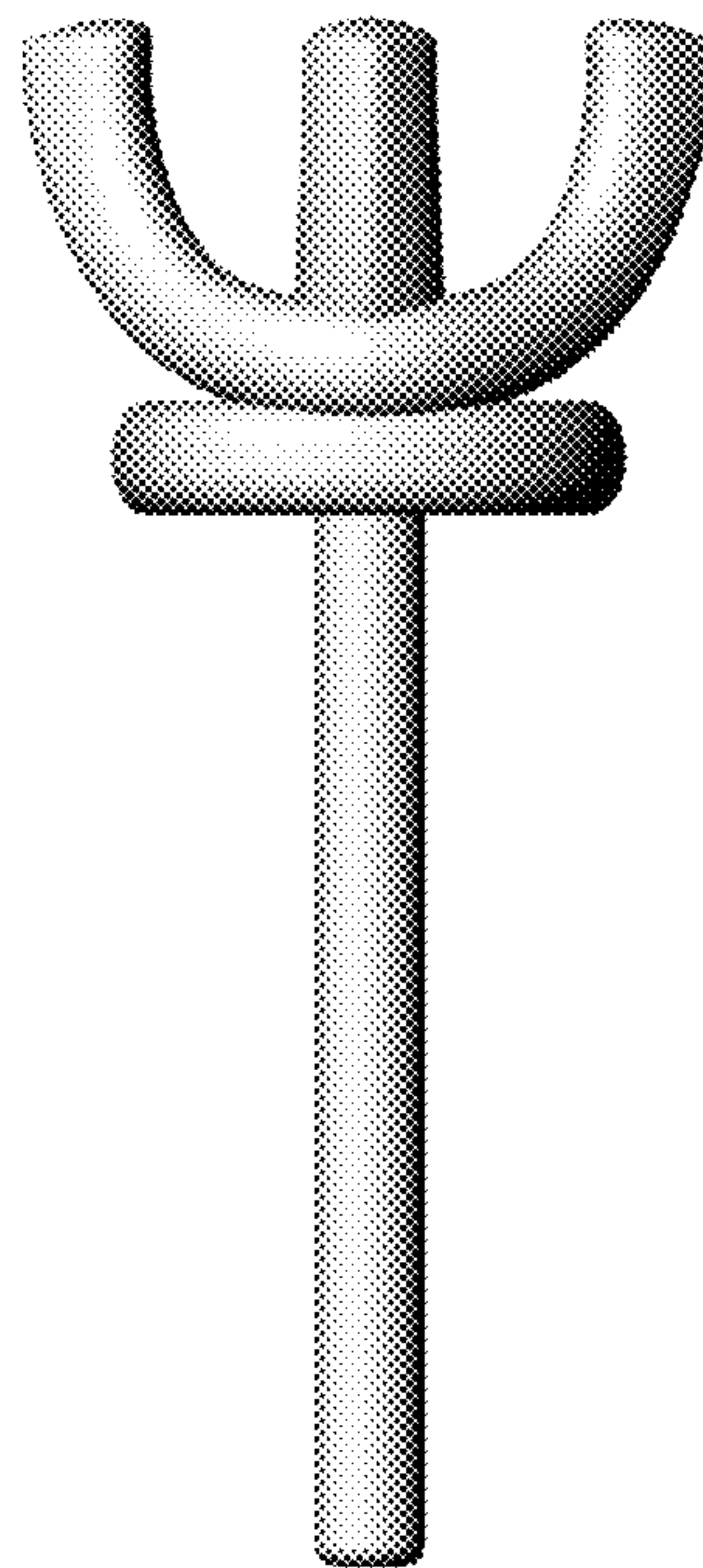

FIG. 7

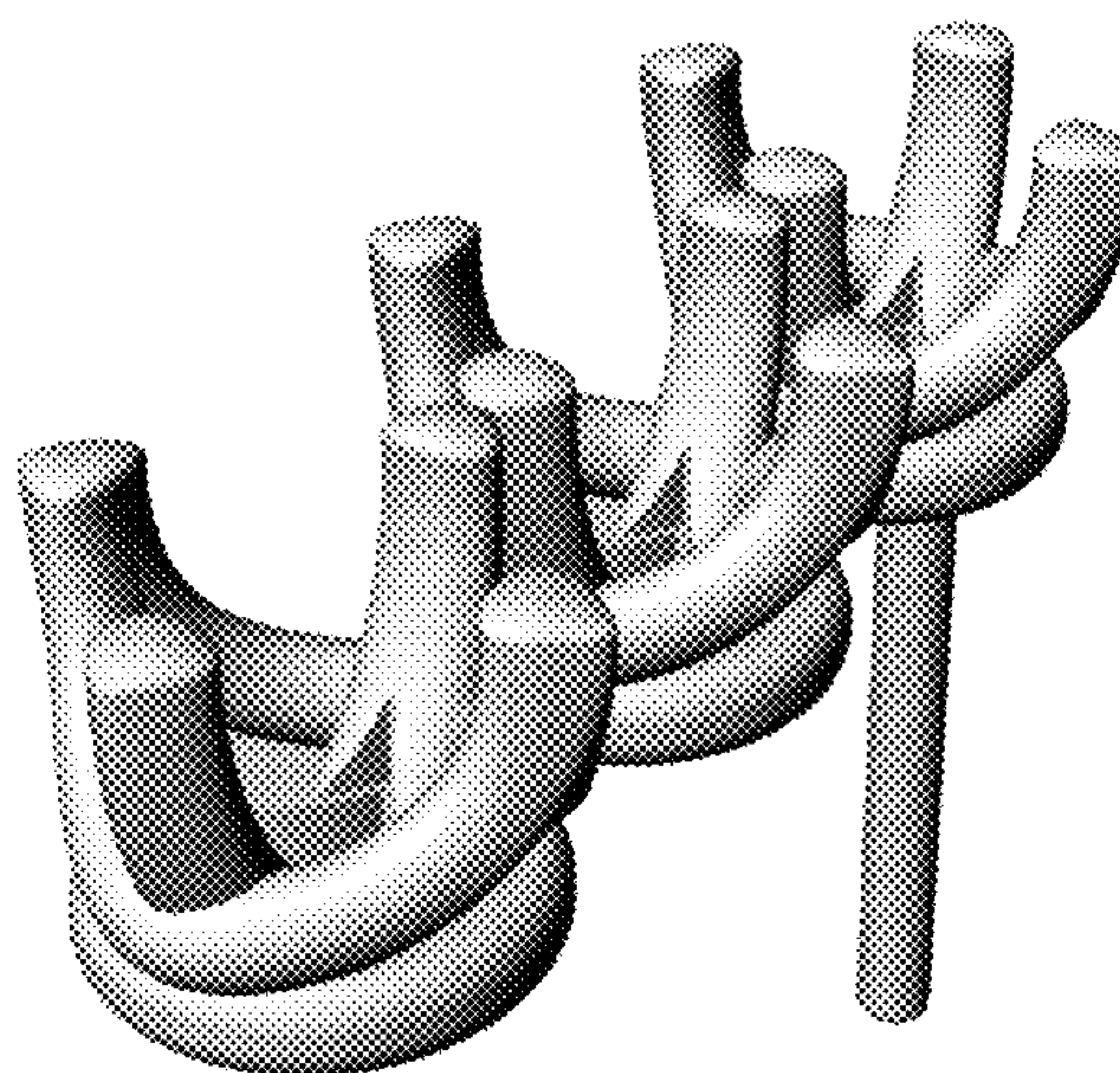

FIG. 8

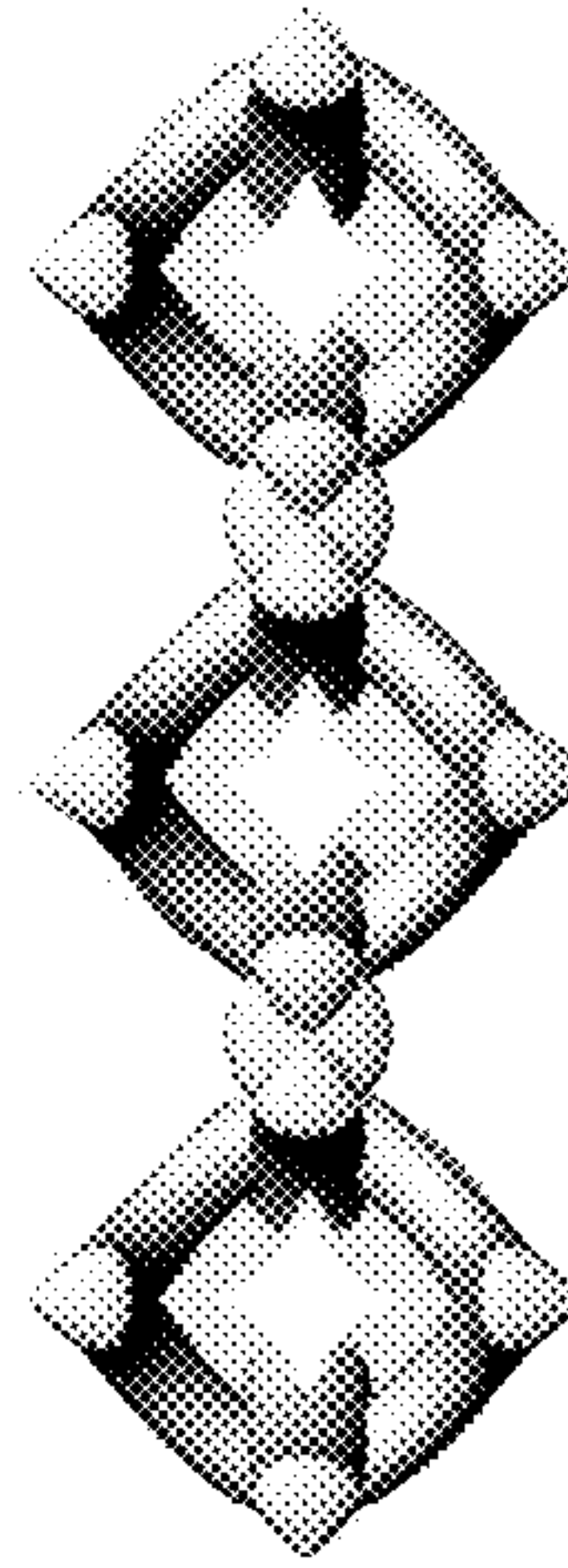

FIG. 9

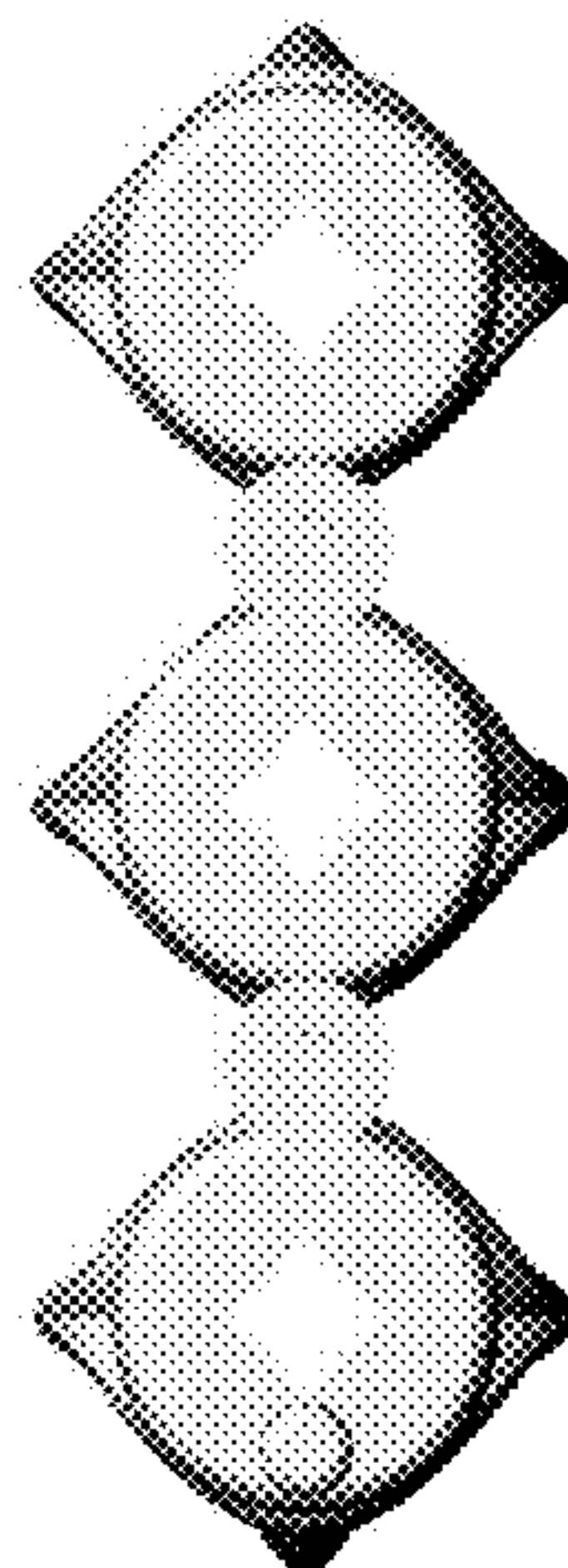



FIG. 10

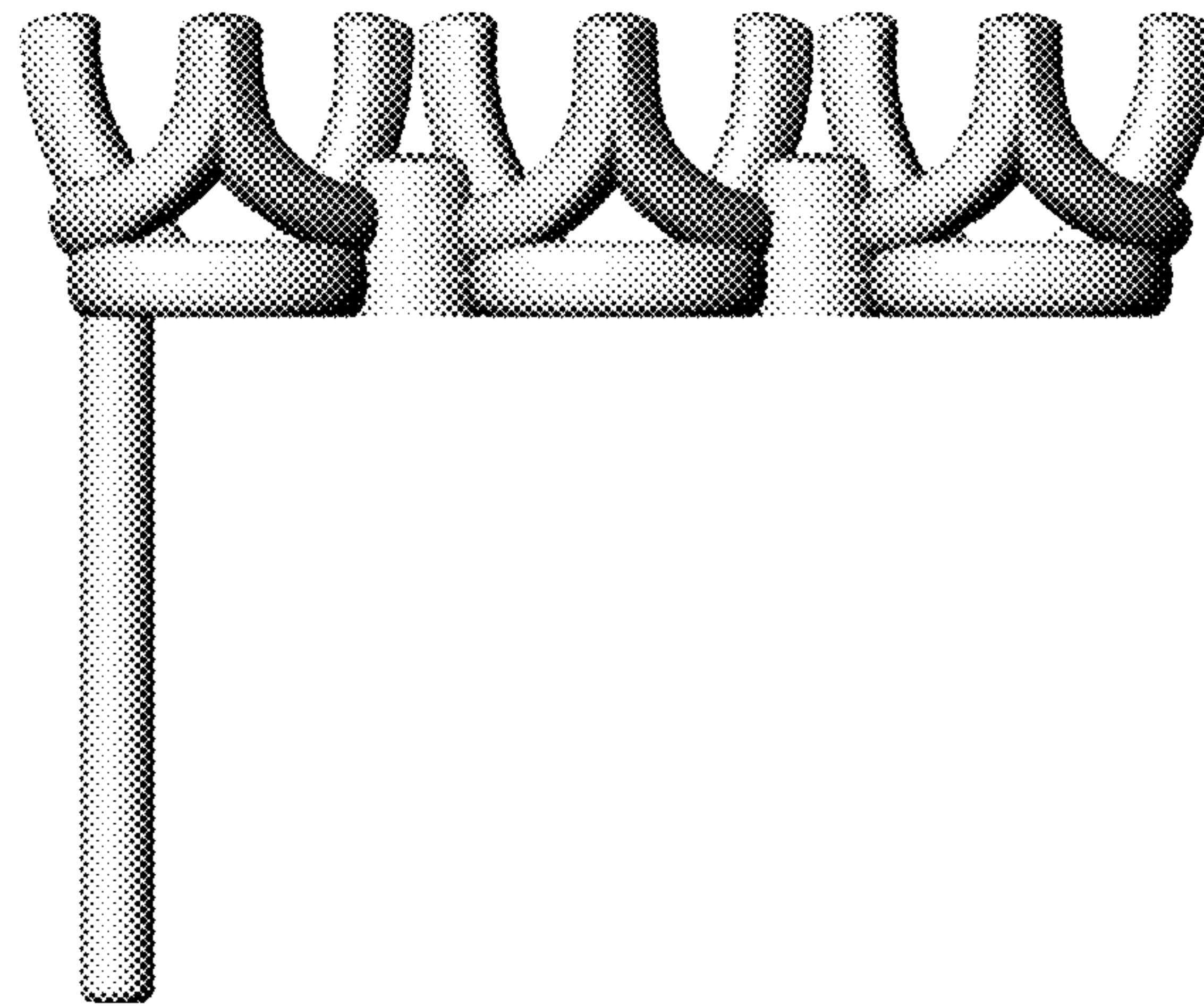

FIG. 11

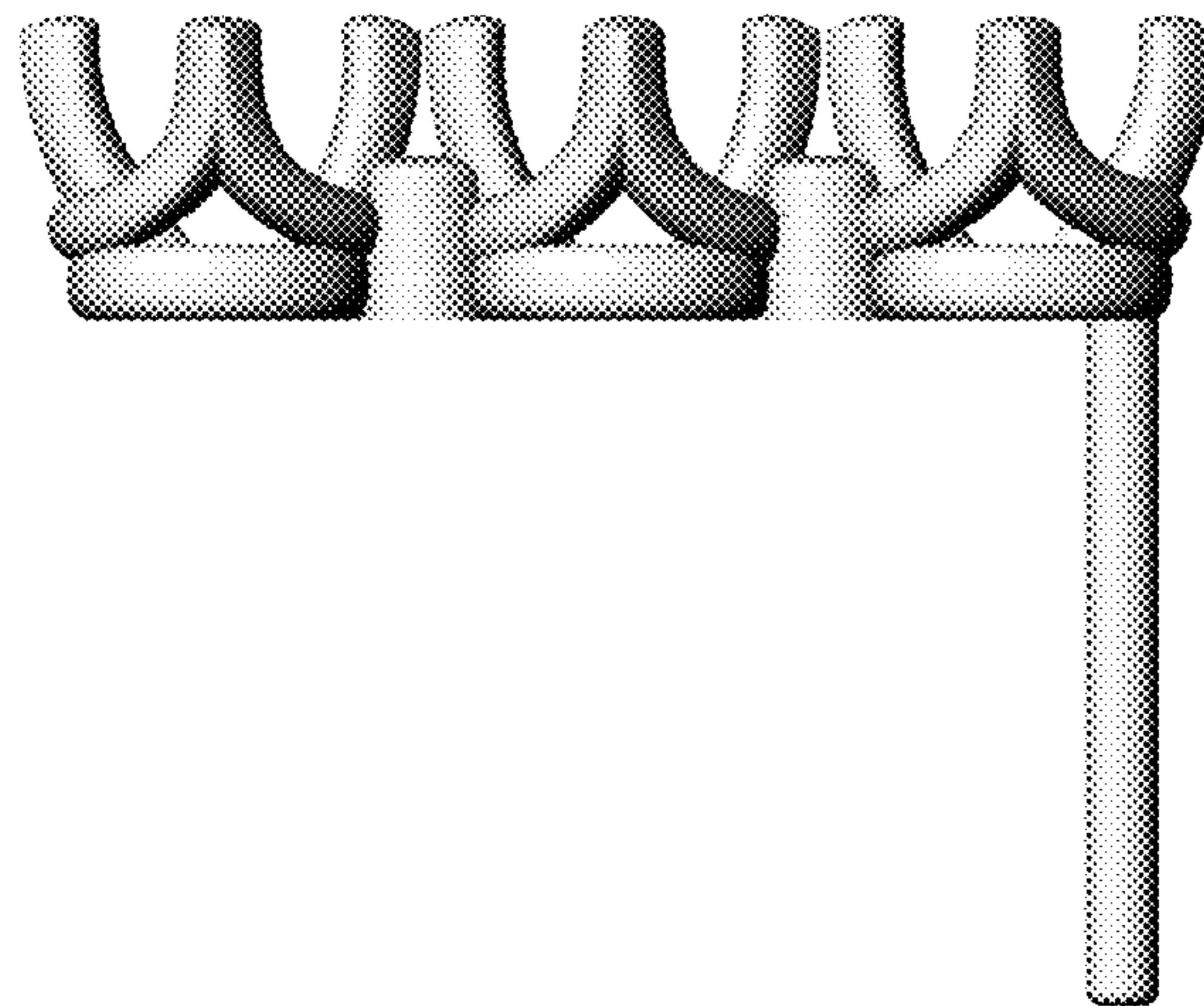

FIG. 12

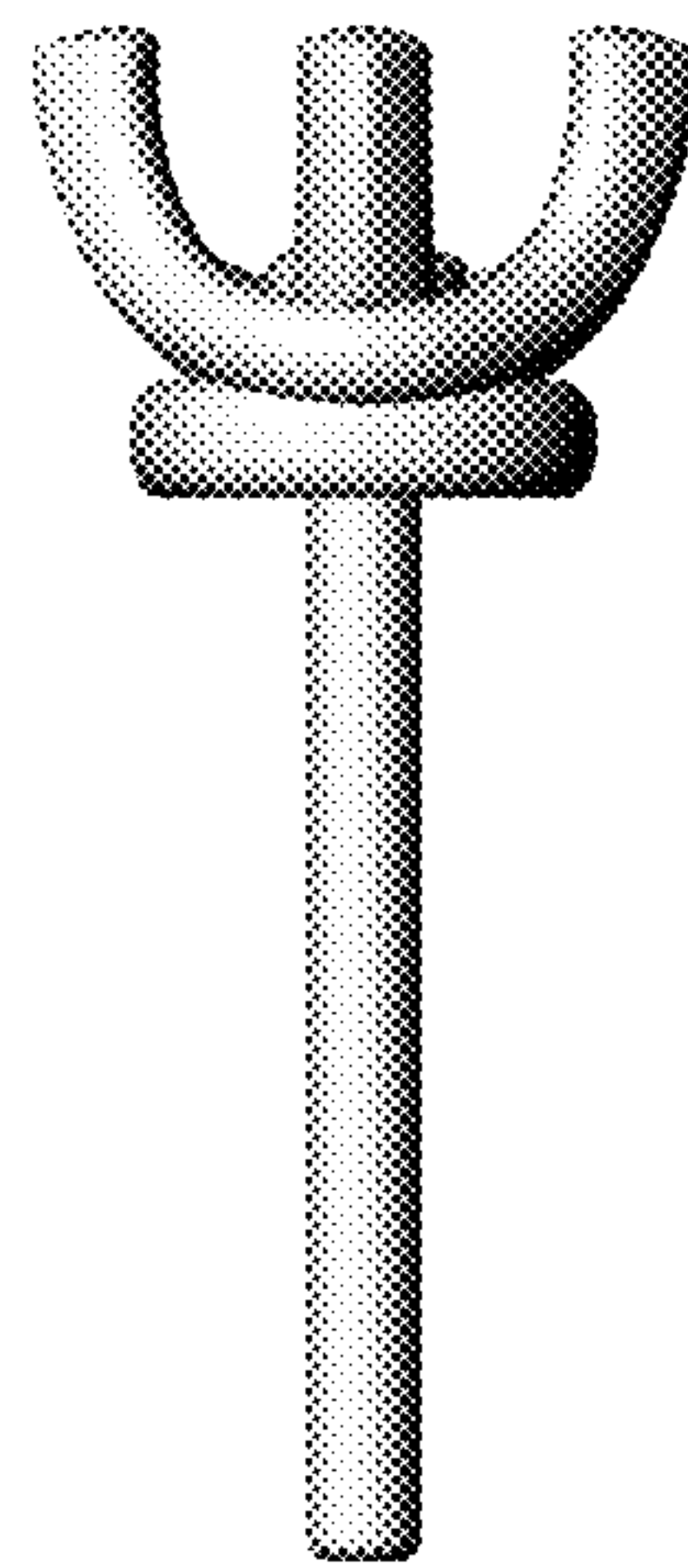

FIG. 13

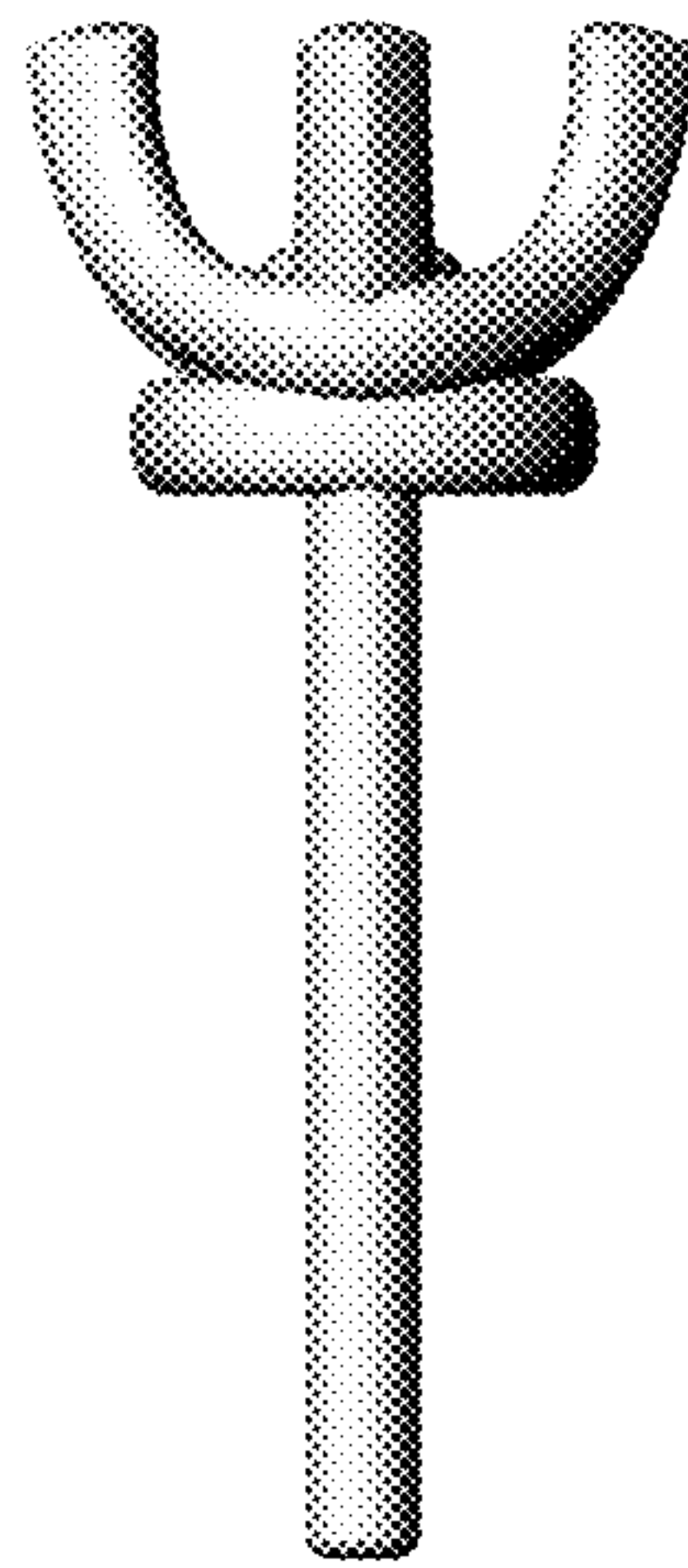



FIG. 14

