



US00D685648S

(12) **United States Design Patent**  
**Berman**

(10) **Patent No.:** **US D685,648 S**  
(45) **Date of Patent:** **\*\* Jul. 9, 2013**

(54) **STRAP POUCH**

(75) Inventor: **Ronald Berman**, Long Beach, CA (US)

(73) Assignee: **Saddlesprings, Inc.**, Carson, CA (US)

(\*\*) Term: **14 Years**

(21) Appl. No.: **29/423,135**

(22) Filed: **May 29, 2012**

(51) **LOC (9) Cl.** ..... **09-05**

(52) **U.S. Cl.**  
USPC ..... **D9/710**

(58) **Field of Classification Search**  
USPC ..... D9/702-714, 720-722, 414, 434-435,  
D9/696, 716, 771, 447, 522, 571-575, 682,  
D9/738-747, 516-517, 529-530, 547-549,  
D9/569, 537-538, 544, 503-505, 545; 383/6,  
383/9, 22, 96, 61.1, 80-81, 104, 901, 63,  
383/203, 107, 119, 120, 123; D24/118, 207;  
222/107, 92, 206; 604/408, 410, 403;  
220/495.03, 669, 675; 215/381-385, 12.1;  
D3/202, 303, 232, 244

See application file for complete search history.

(56) **References Cited**

U.S. PATENT DOCUMENTS

D453,295	S	*	2/2002	Bell et al.	.....	D9/710
D455,645	S	*	4/2002	Bell et al.	.....	D9/710
D571,672	S	*	6/2008	Murray	.....	D9/710
D584,168	S	*	1/2009	Murray	.....	D9/710
D666,922	S	*	9/2012	Khan	.....	D9/709
D676,335	S	*	2/2013	Murray	.....	D9/707
D676,336	S	*	2/2013	Murray	.....	D9/707

\* cited by examiner

*Primary Examiner* — Caron D Veynar

*Assistant Examiner* — Abraham Bahta

(74) *Attorney, Agent, or Firm* — Fulwider Patton LLP

(57) **CLAIM**

The ornamental design for an strap pouch, as shown and described.

**DESCRIPTION**

FIG. 1 is a perspective view of my new design;  
FIG. 2 is a front view thereof;  
FIG. 3 is a rear view thereof;  
FIG. 4 is a left side view thereof;  
FIG. 5 is a right side view thereof;  
FIG. 6 is a top view thereof; and,  
FIG. 7 is a bottom view thereof.

**1 Claim, 5 Drawing Sheets**

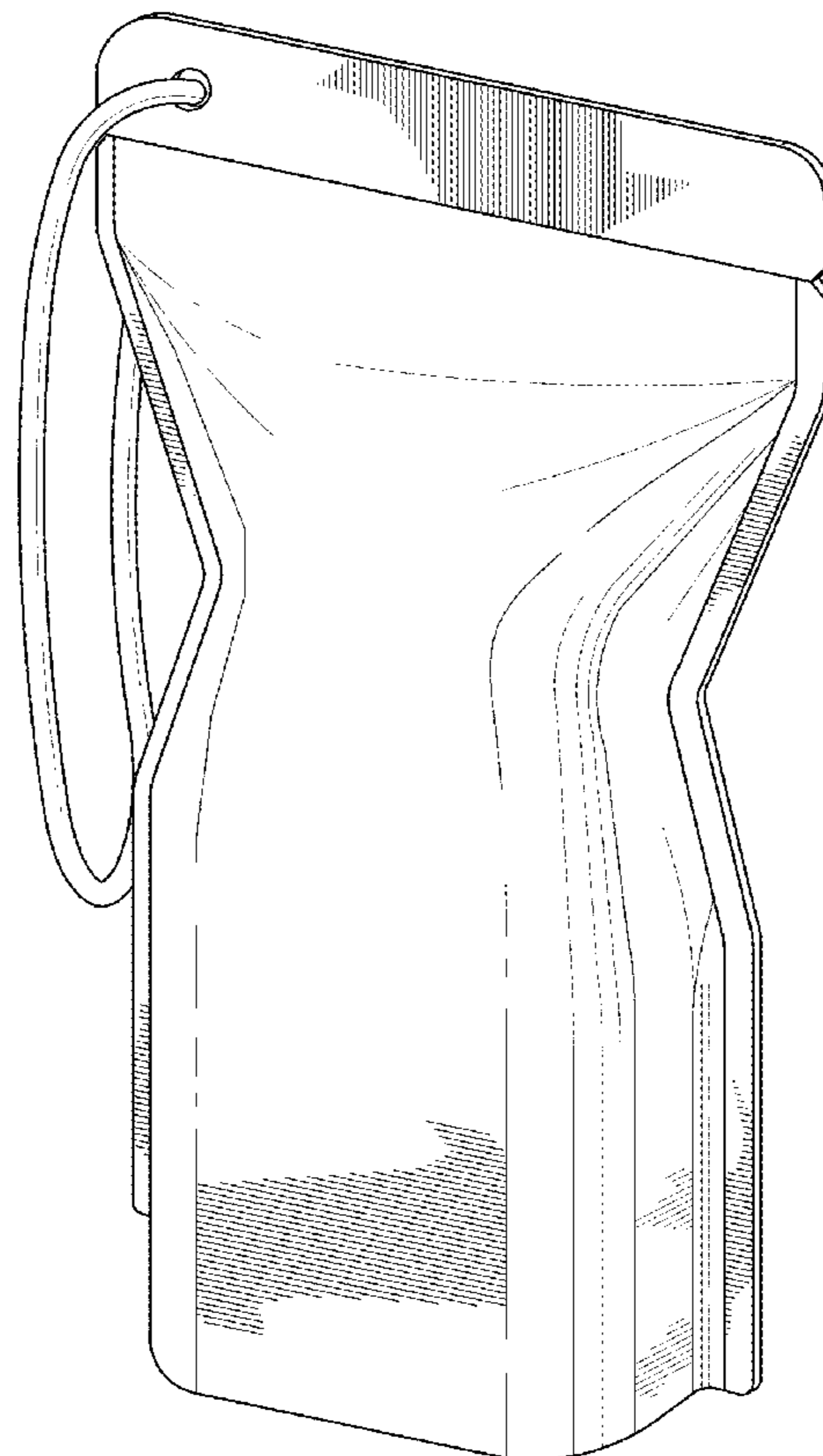

*FIG. 1*

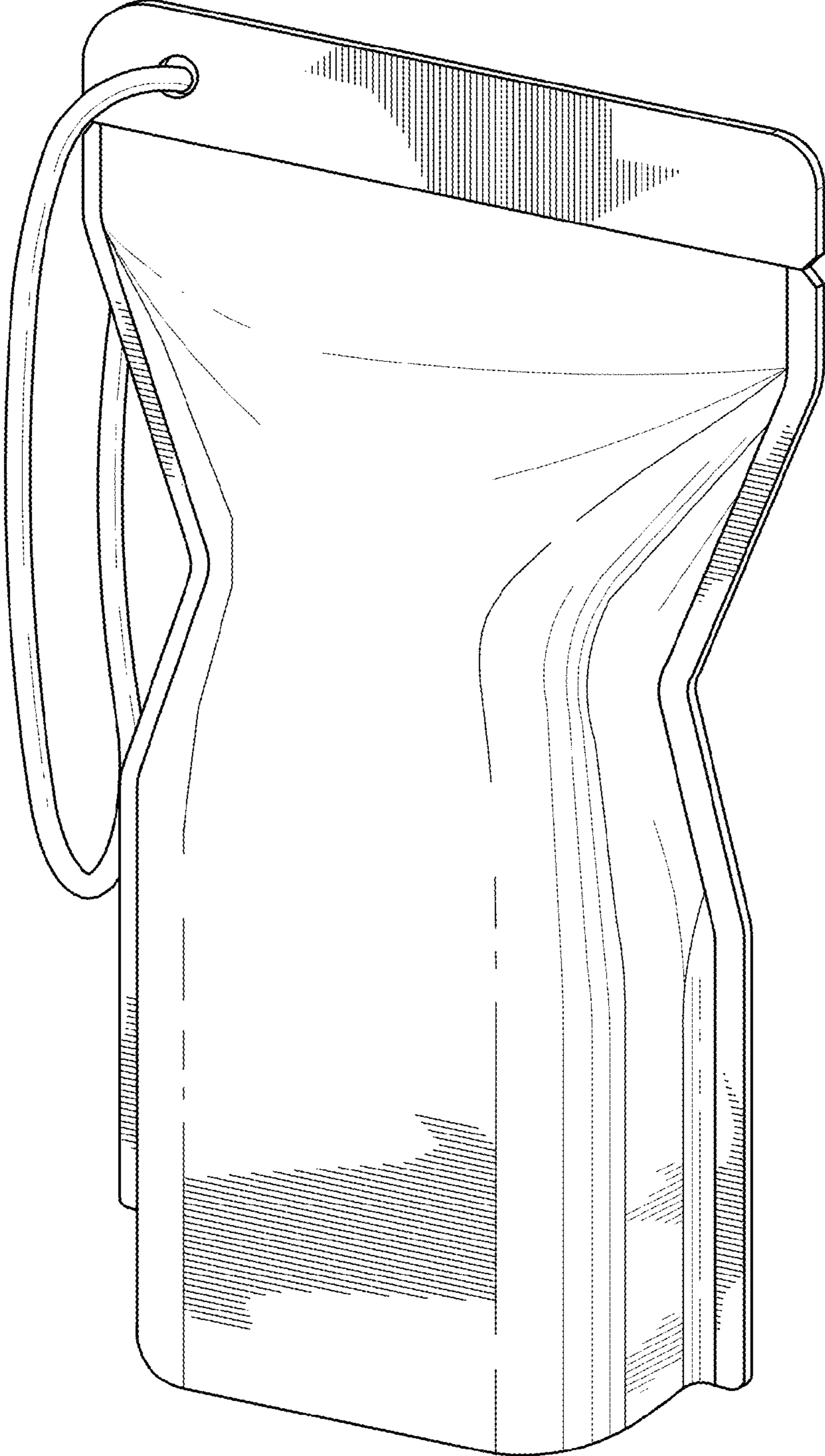
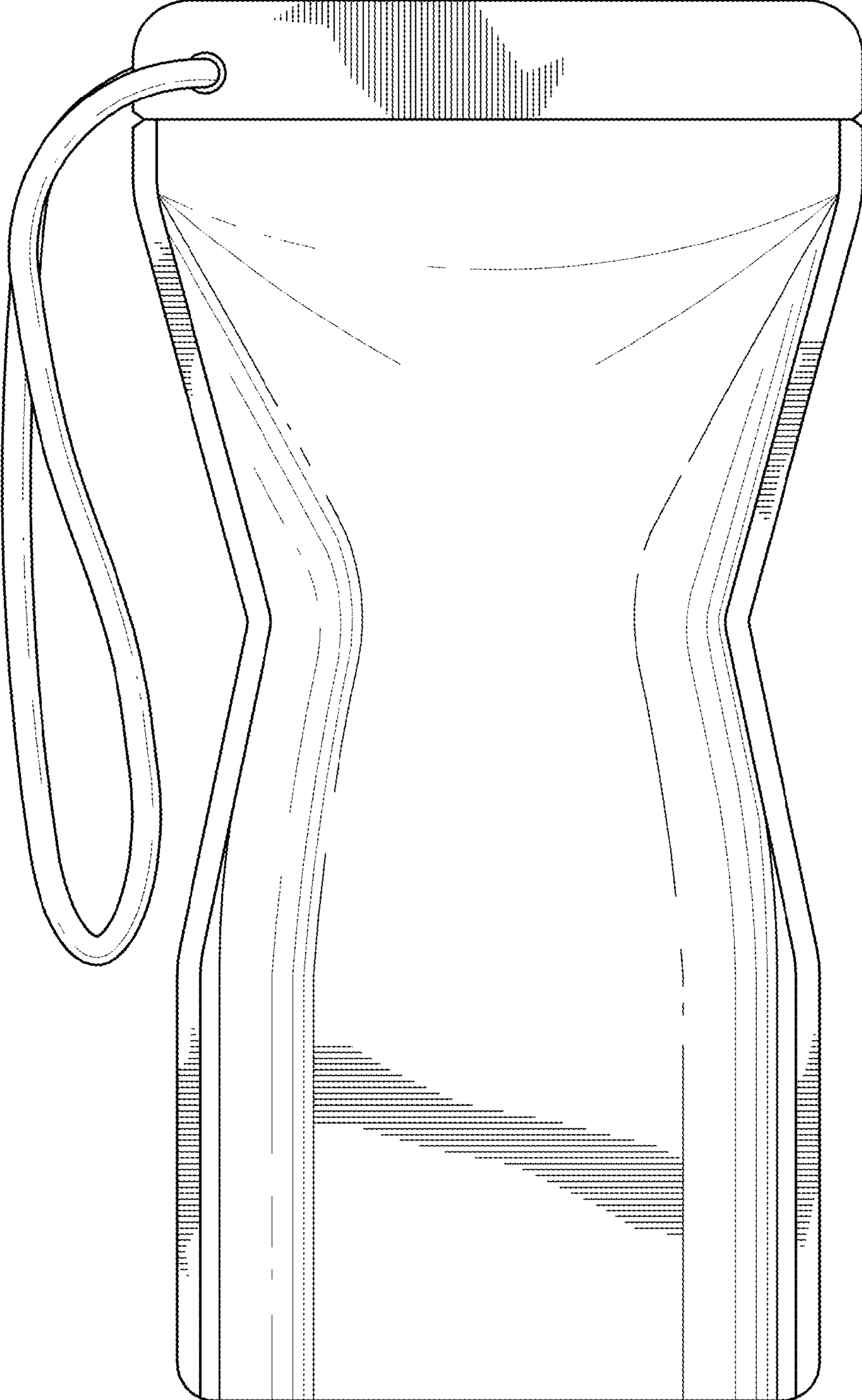
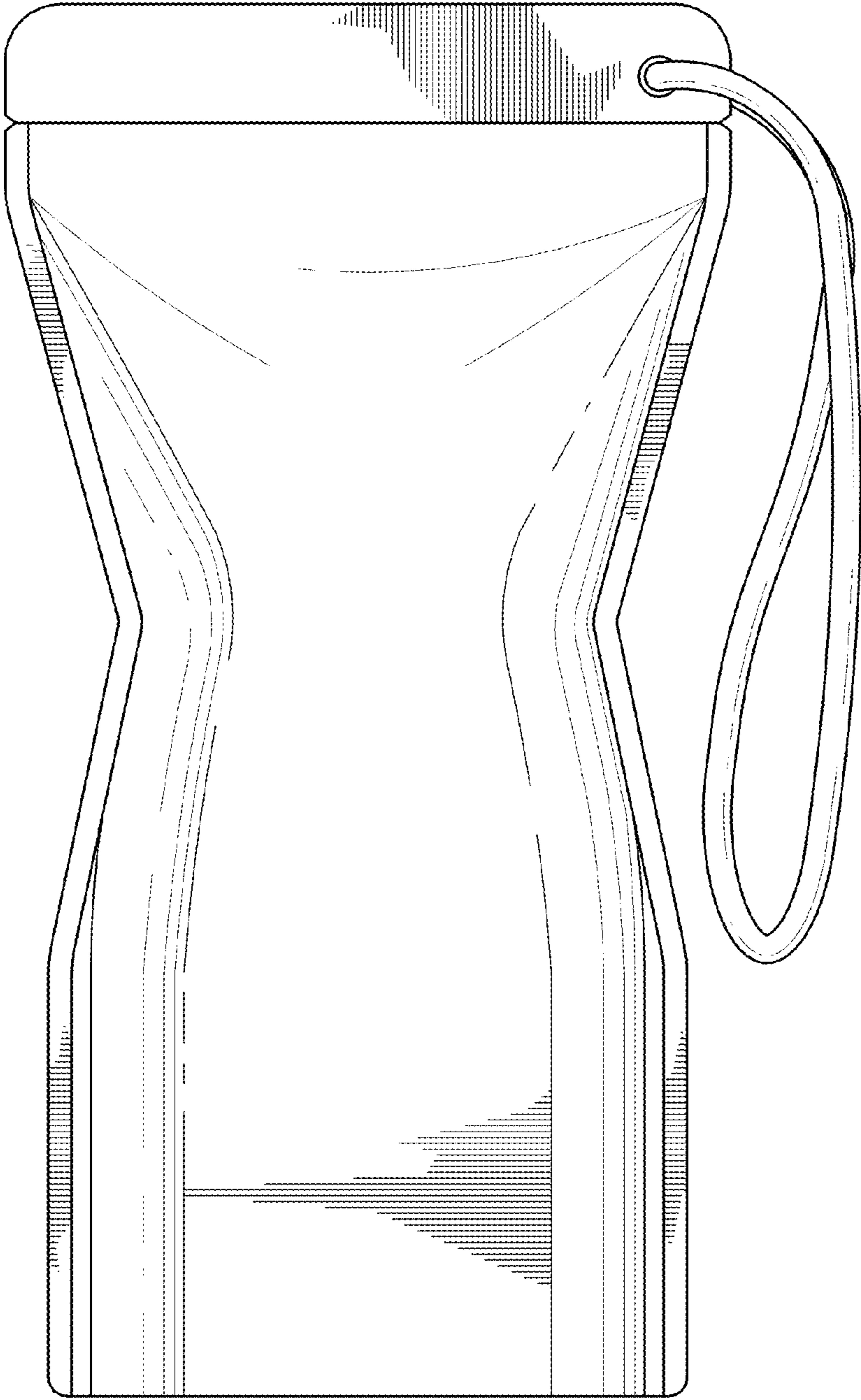

FIG. 2



*FIG. 3*



*FIG. 4*

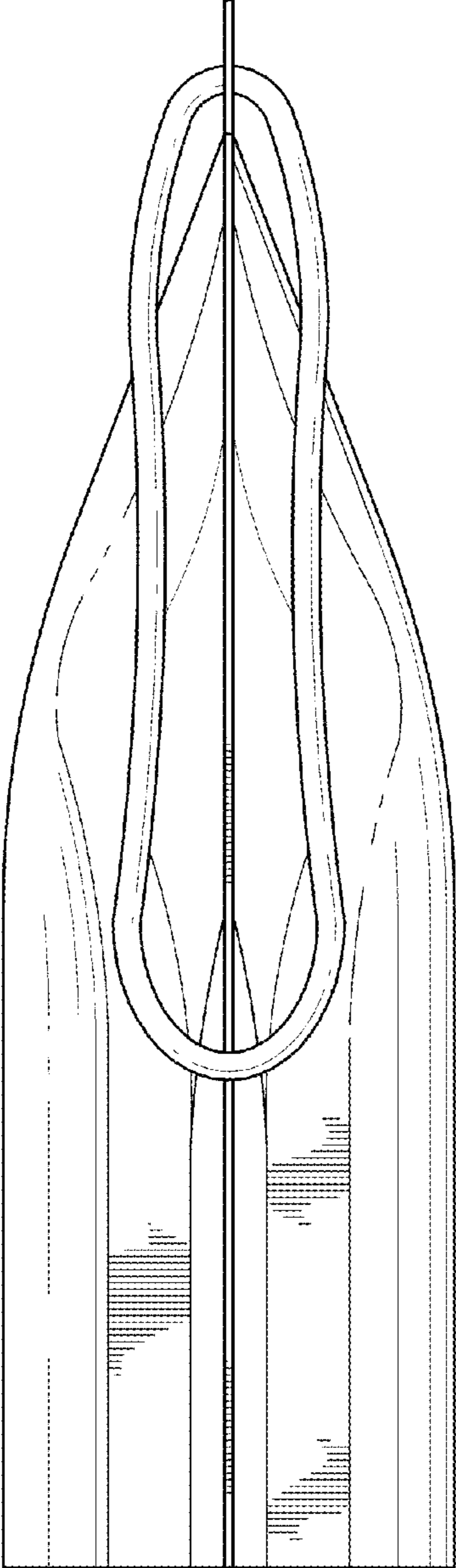

*FIG. 5*

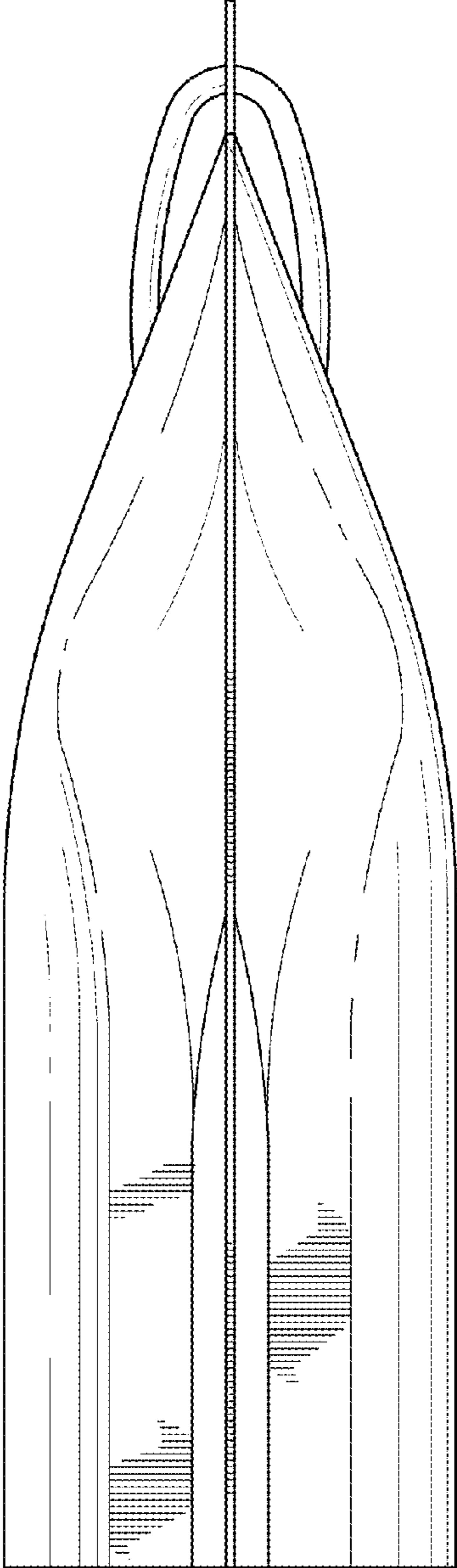

*FIG. 6*

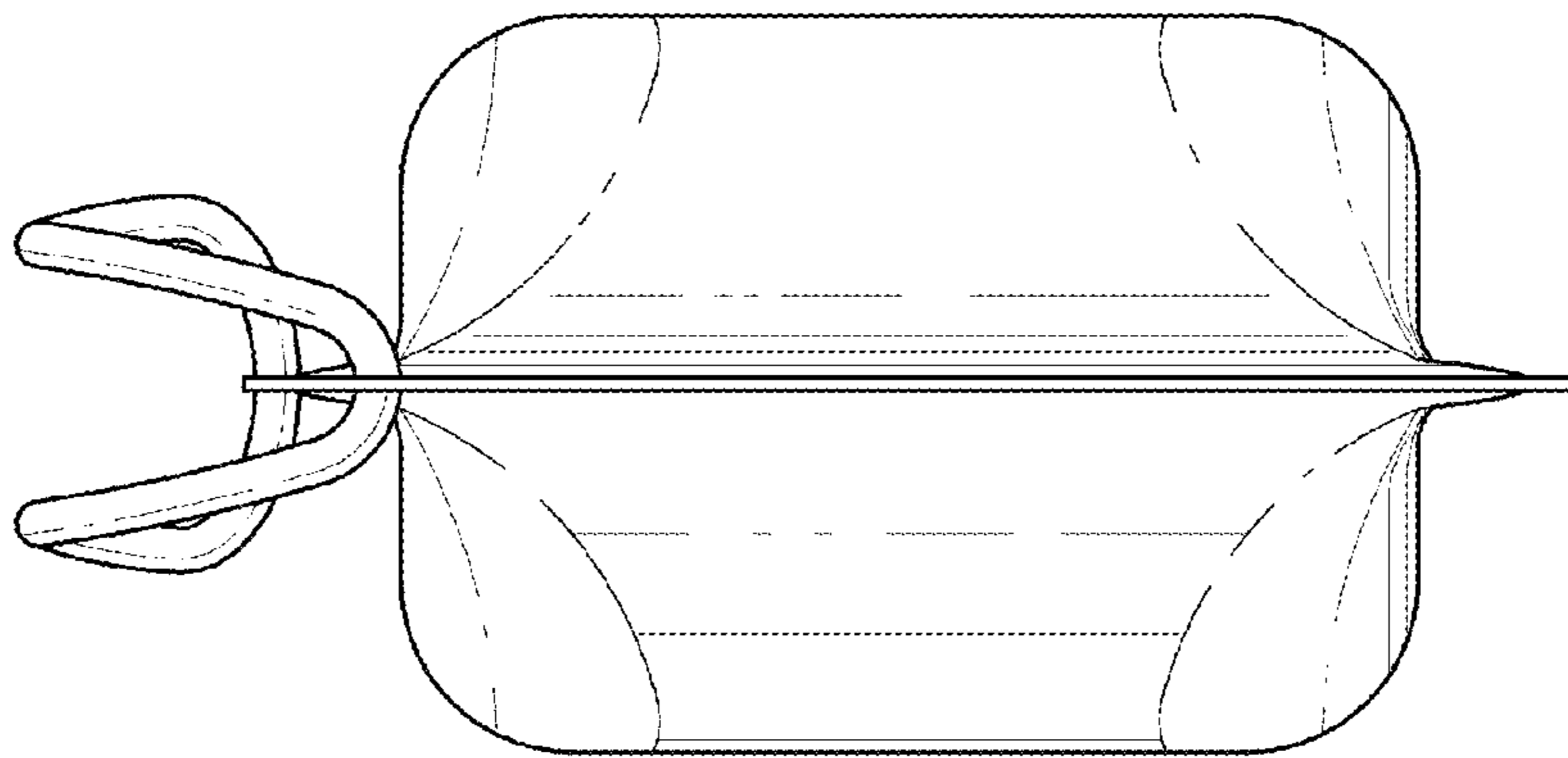

*FIG. 7*

