



US00D685599S

(12) **United States Design Patent**  
**Miller et al.**

(10) **Patent No.:** **US D685,599 S**

(45) **Date of Patent:** **\*\* Jul. 9, 2013**

(54) **BEVERAGE DISPENSER**

(75) Inventors: **Amanda Miller**, Minneapolis, MN (US);  
**Richard P. Riedel**, Blaine, MN (US)

(73) Assignee: **Target Brands, Inc.**, Minneapolis, MN (US)

(\*\*) Term: **14 Years**

(21) Appl. No.: **29/415,217**

(22) Filed: **Mar. 8, 2012**

(51) **LOC (9) Cl.** ..... **07-01**

(52) **U.S. Cl.**  
USPC ..... **D7/306; D7/313**

(58) **Field of Classification Search**  
USPC . D7/313, 306-311, 300; 220/630; 222/185.1,  
222/131; 99/306, 307, 289 R; D23/209  
See application file for complete search history.

(56) **References Cited**

**U.S. PATENT DOCUMENTS**

D101,724	S	*	10/1936	Worthington	.....	D7/313
3,910,461	A	*	10/1975	Eager	.....	222/131
3,971,304	A	*	7/1976	Cvitkovich	.....	99/291
D244,929	S	*	7/1977	Armstrong	.....	D7/313
4,060,184	A	*	11/1977	O'Neil, Sr.	.....	222/501
D356,713	S		3/1995	Groover		
D358,289	S	*	5/1995	Thies et al.	.....	D7/306
D378,883	S	*	4/1997	Magnusson	.....	D7/306
D380,641	S		7/1997	Randle		
D431,145	S	*	9/2000	Woebcke et al.	.....	D7/306
D464,226	S	*	10/2002	Lassota et al.	.....	D7/306
6,520,368	B1	*	2/2003	Chiu	.....	220/630
D530,141	S	*	10/2006	Wilgus et al.	.....	D7/313
7,350,671	B2	*	4/2008	Mika et al.	.....	222/129
D593,353	S		6/2009	Hoffman et al.		
D602,301	S		10/2009	Romandy		
D610,856	S		3/2010	Hoffman et al.		
D612,658	S	*	3/2010	Schenk	.....	D7/307

D655,124	S	*	3/2012	Schenk	.....	D7/307
D655,561	S	*	3/2012	Wang	.....	D7/306
2010/0212419	A1		8/2010	Radhakrishnan et al.		

**OTHER PUBLICATIONS**

Office Action from Canadian Patent Application No. 147,049, mailed Feb. 4, 2013 (2 pages).  
"Strata Stackable Juice Dispensers," www.candyconceptsinc.com/Strata-Stackable-Juice-Dispenser-p5093.html, available at least as early as Oct. 9, 2010 per www.internetarchive.org (2 pages).

(Continued)

*Primary Examiner* — Marianne Pandozzi

(74) *Attorney, Agent, or Firm* — Griffiths & Seaton PLLC;  
JoAnn M. Seaton

(57) **CLAIM**

The ornamental design for a beverage dispenser, as shown and described.

**DESCRIPTION**

FIG. 1 is a front, perspective view of a beverage dispenser showing our new design;  
FIG. 2 is a front view thereof;  
FIG. 3 is a rear view thereof;  
FIG. 4 is a right side view thereof; the left side view being a mirror image of the right side view;  
FIG. 5 is a top view thereof; and  
FIG. 6 is a bottom view thereof.  
FIG. 7 is a front, perspective view of the beverage dispenser of FIG. 1 shown with environmental subject matter;  
FIG. 8 is a front view thereof;  
FIG. 9 is a rear view thereof;  
FIG. 10 is a right side view thereof; the left side view being a mirror image of the right side view;  
FIG. 11 is a top view thereof; and,  
FIG. 12 is a bottom view thereof.

**1 Claim, 12 Drawing Sheets**

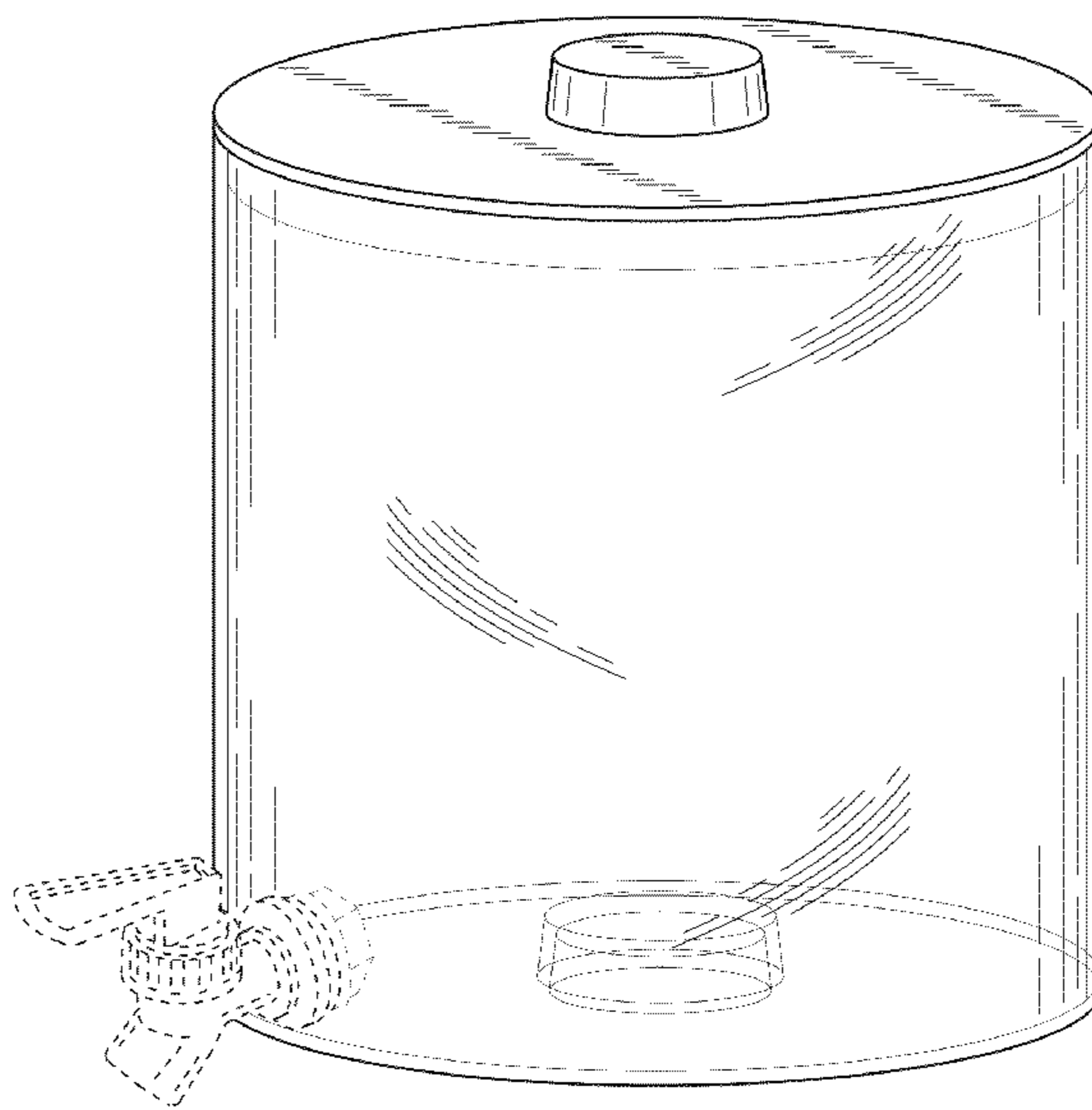

OTHER PUBLICATIONS

“Creativeware BEV07CLR Stacking Beverage Dispenser,” printed from [www.google.com/products/catalog?client=safari&rls=en&q=st...036545&sa=X&ei=SE6VTqHtNojc0QGx7qTHBw&ved=0CHcQ8w1wAg#ps-sellers](http://www.google.com/products/catalog?client=safari&rls=en&q=st...036545&sa=X&ei=SE6VTqHtNojc0QGx7qTHBw&ved=0CHcQ8w1wAg#ps-sellers), on Oct. 12, 2011 (2 pages).  
“3-Gallon Beverage Dispensers,” printed from [www.improvementscatalog.com/imp/20080?cm\\_mmc=](http://www.improvementscatalog.com/imp/20080?cm_mmc=)

NEXTAG-\_-S...=MP1NEXTAG&mr:referralID=22b3d09b-f4ac-11e0-9866-001b2166becc, on Oct. 12, 2011 (2 pages).  
“Norfolk Double Glass Beverage Dispenser,” printed from [www.jcpenny.com/jcp/X6.aspx?DeptID=83527&CatID=83527&Gr...Berverage20Dispenser&srccode=cii\\_9324560&cpncode=22-175126904-2](http://www.jcpenny.com/jcp/X6.aspx?DeptID=83527&CatID=83527&Gr...Berverage20Dispenser&srccode=cii_9324560&cpncode=22-175126904-2) on Oct. 12, 2011 (2 pages).

\* cited by examiner

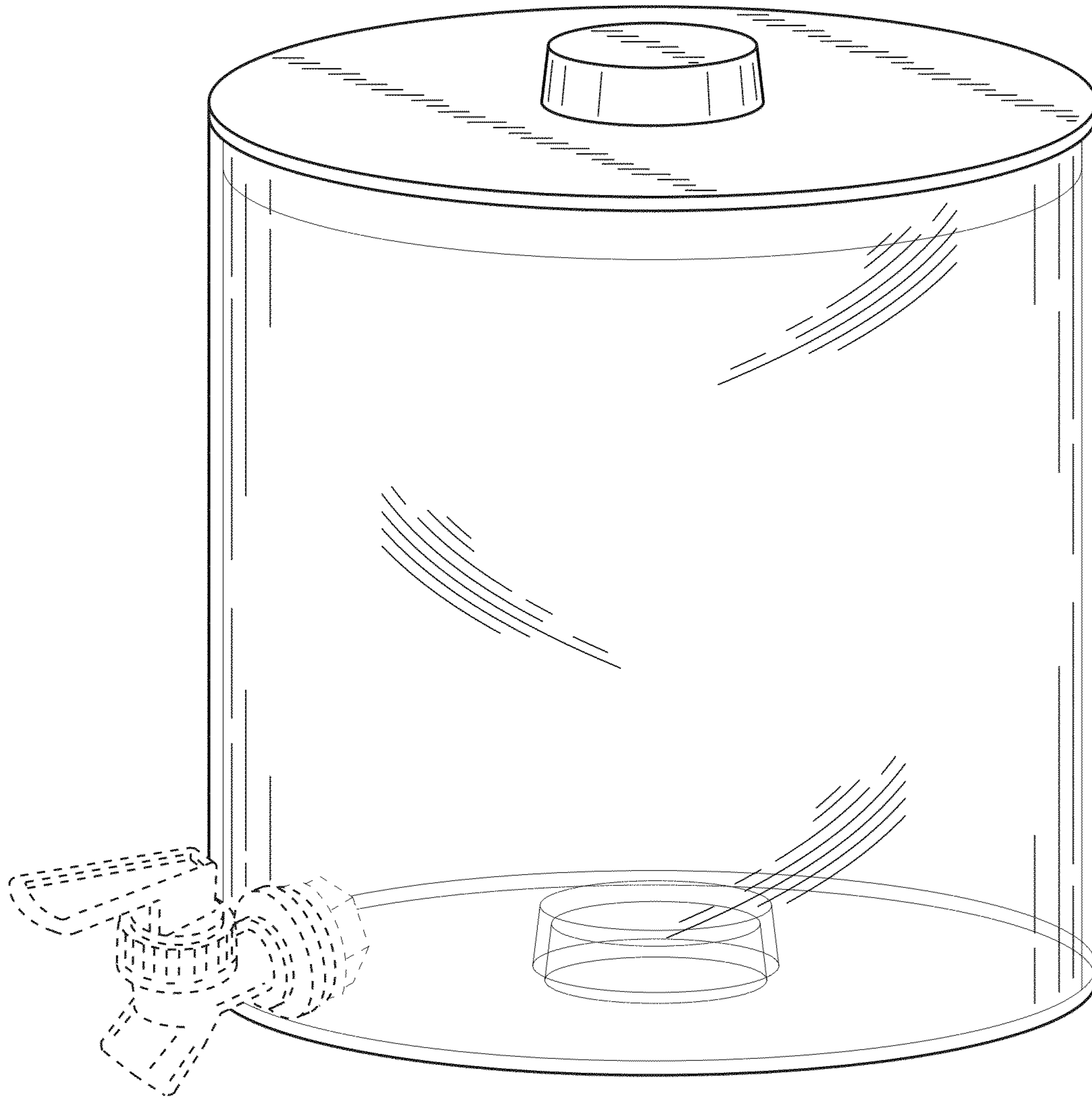

FIG. 1

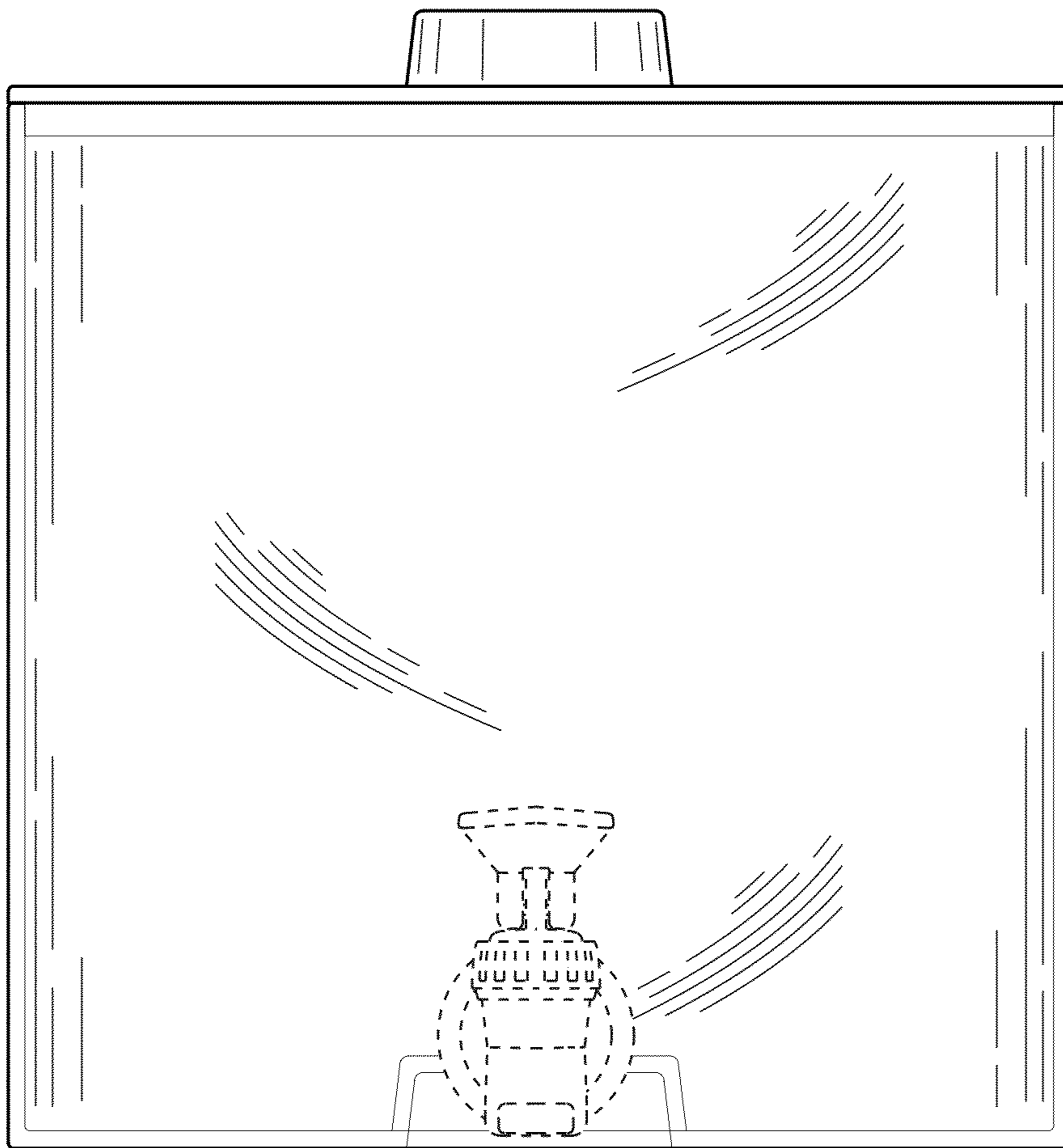

FIG. 2

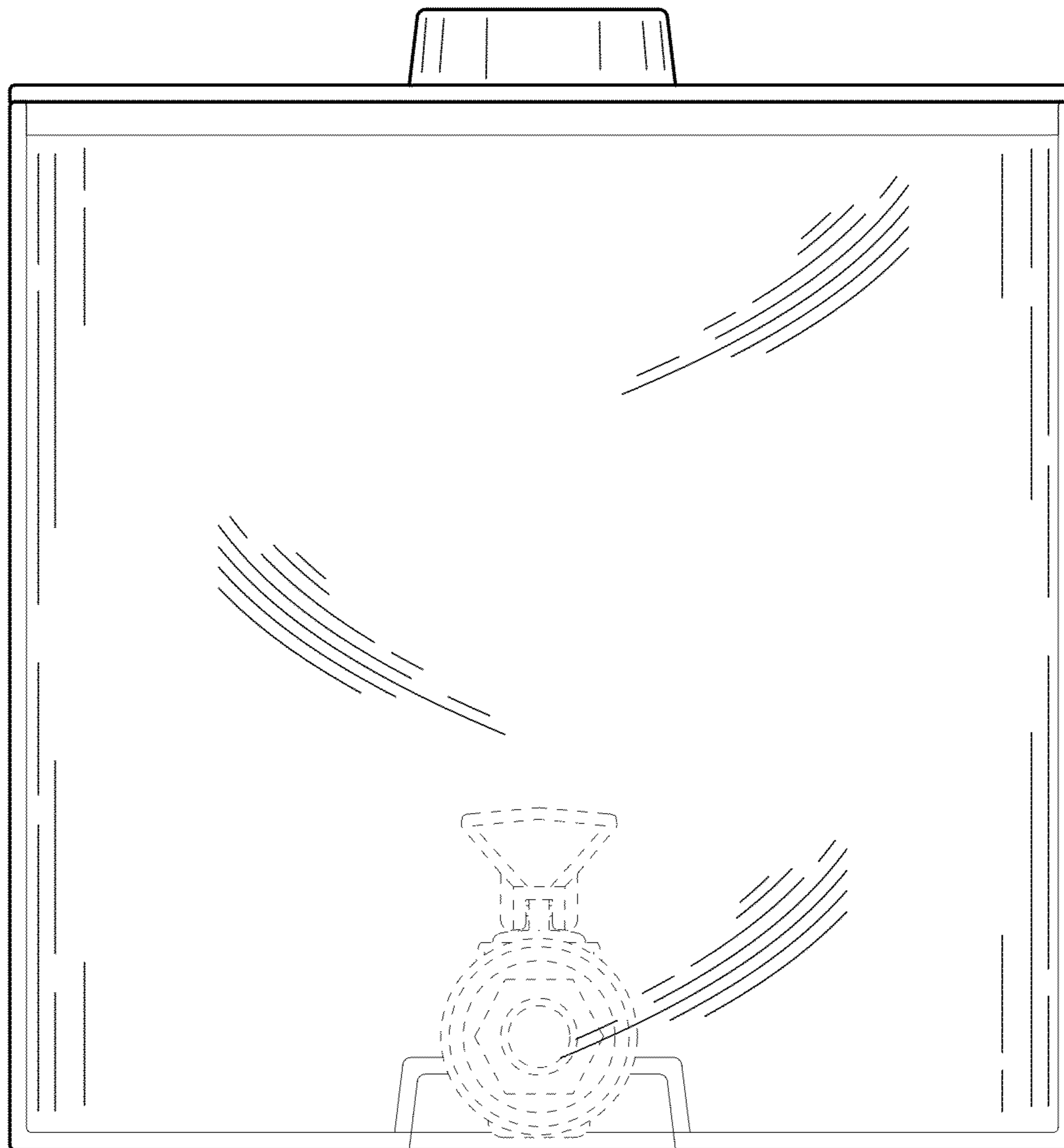

FIG. 3

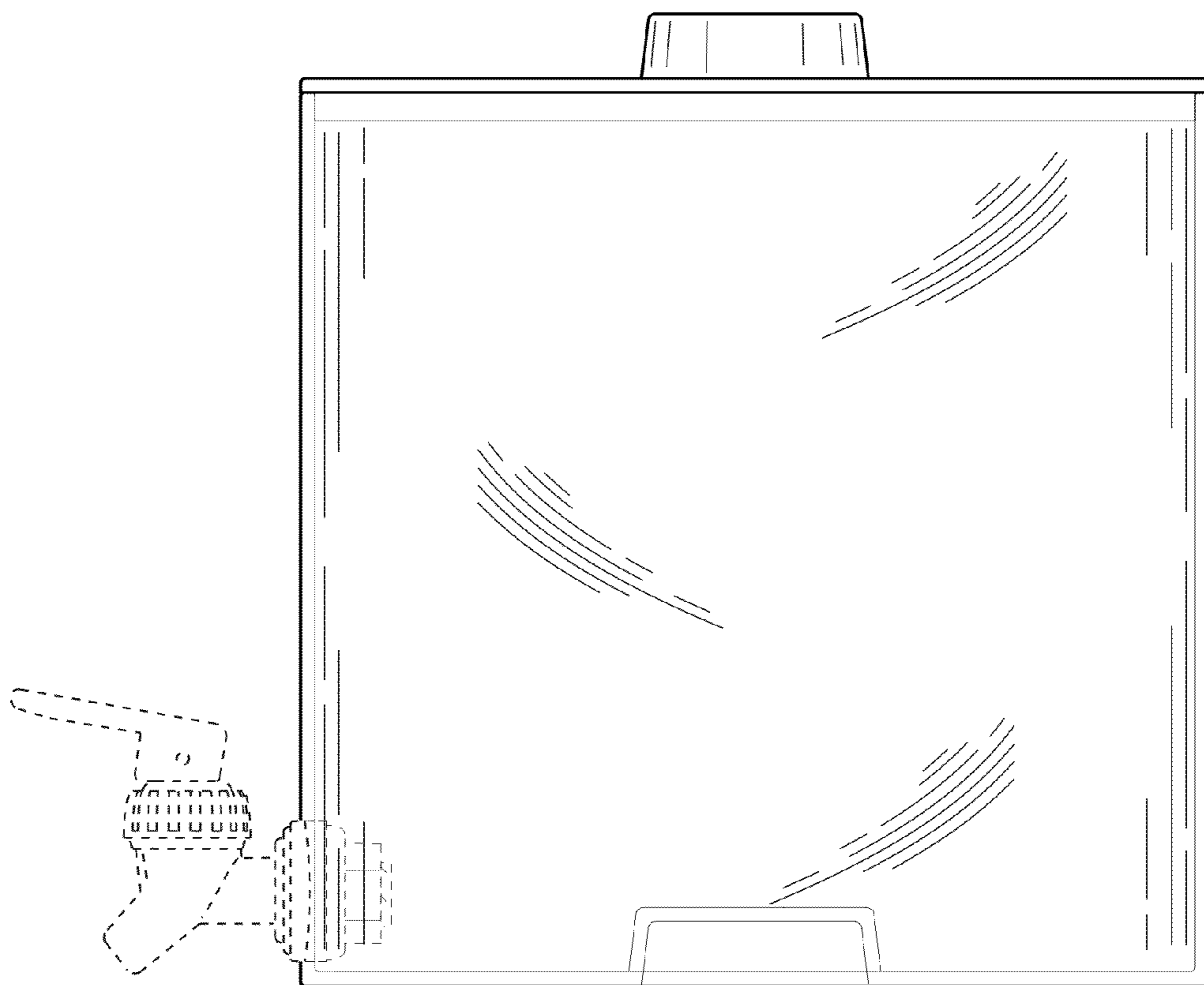
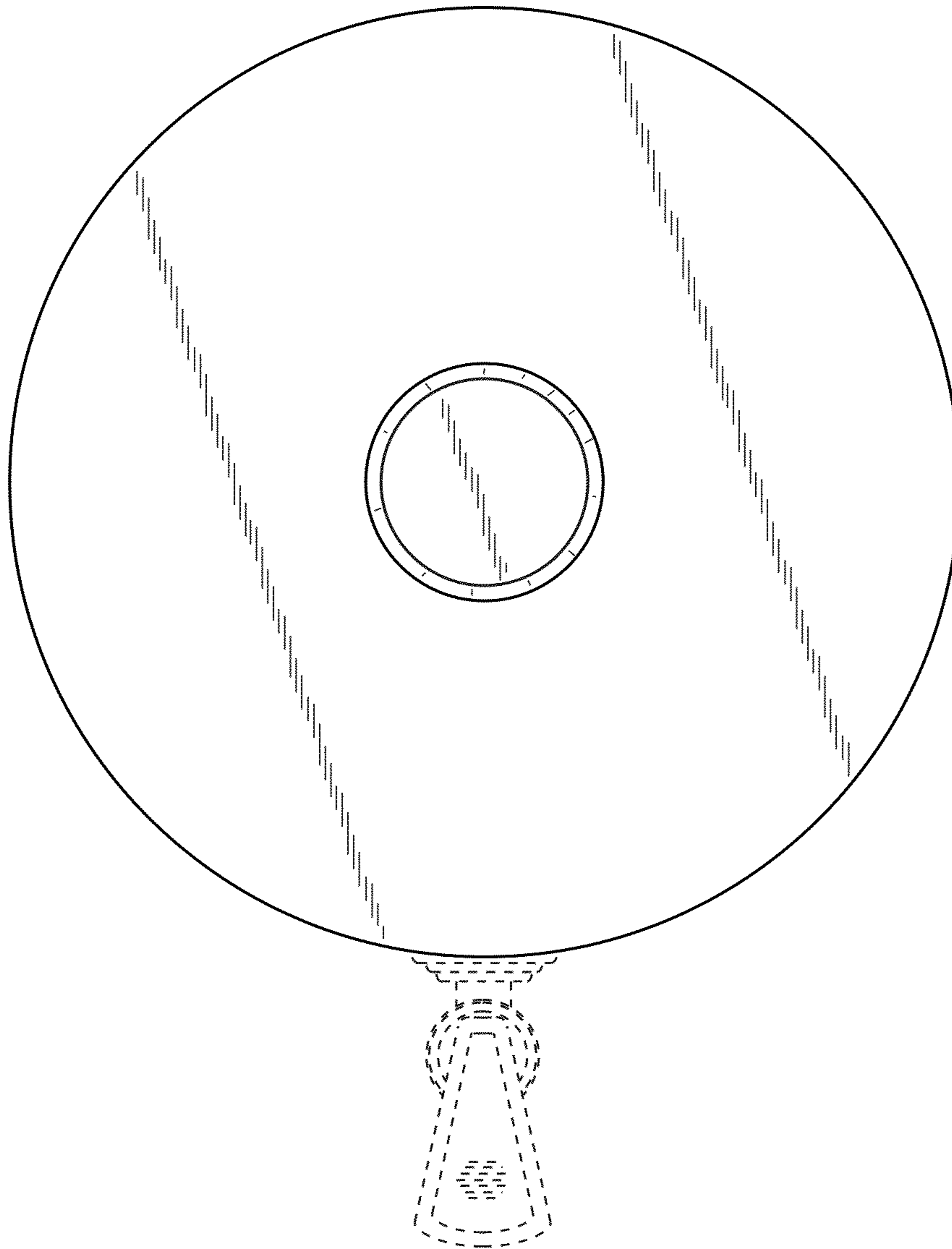

FIG. 4



**FIG. 5**

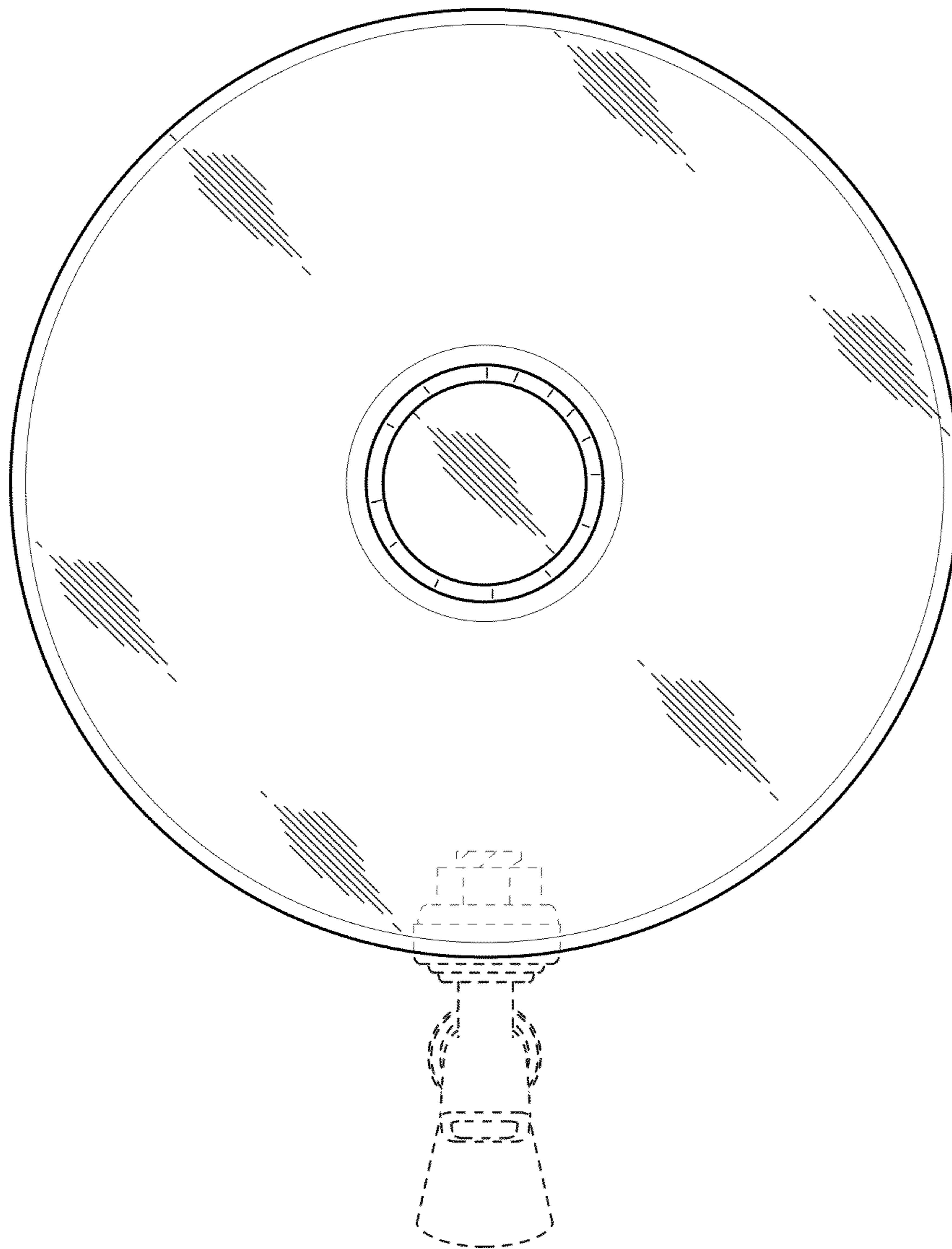

FIG. 6



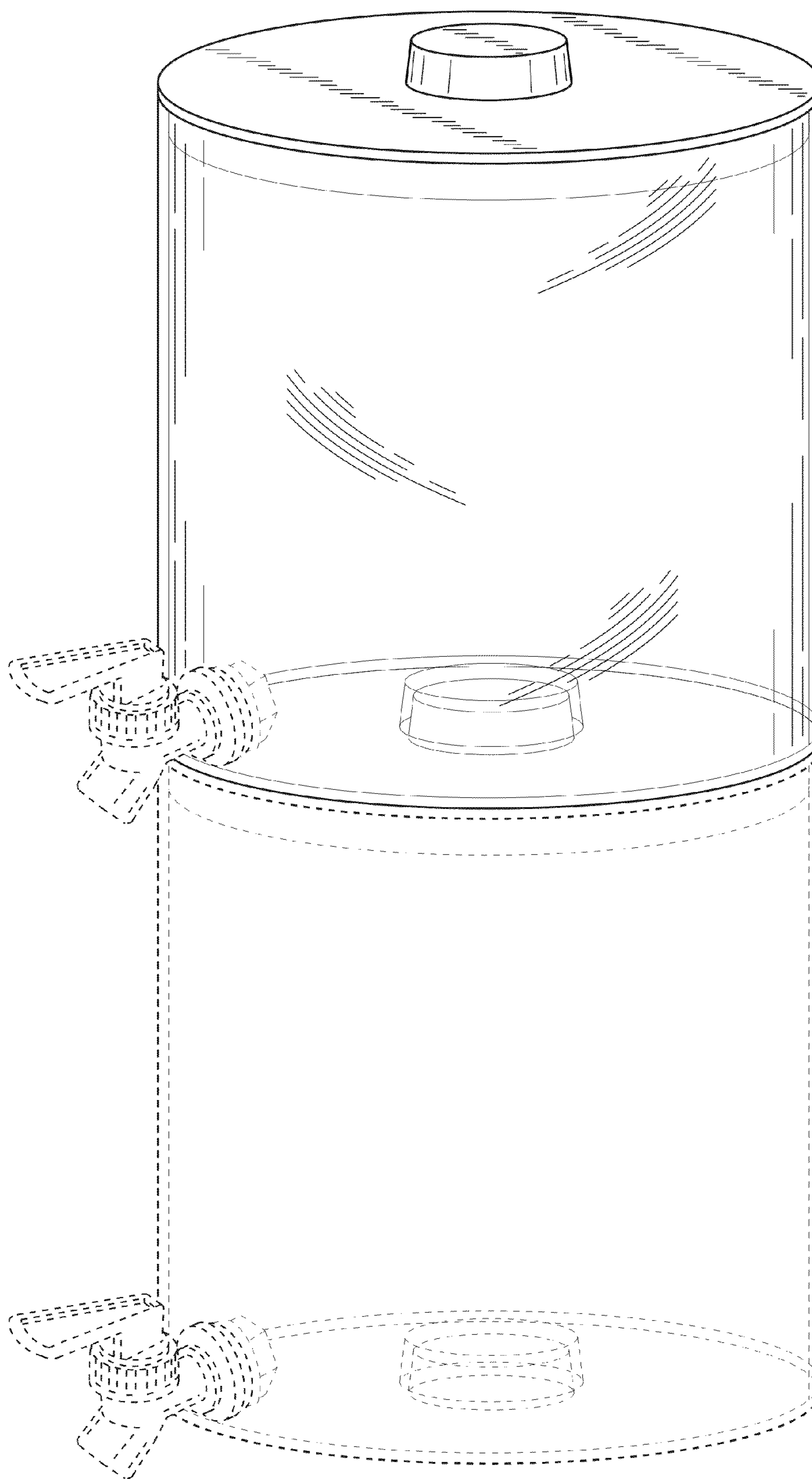

FIG. 7

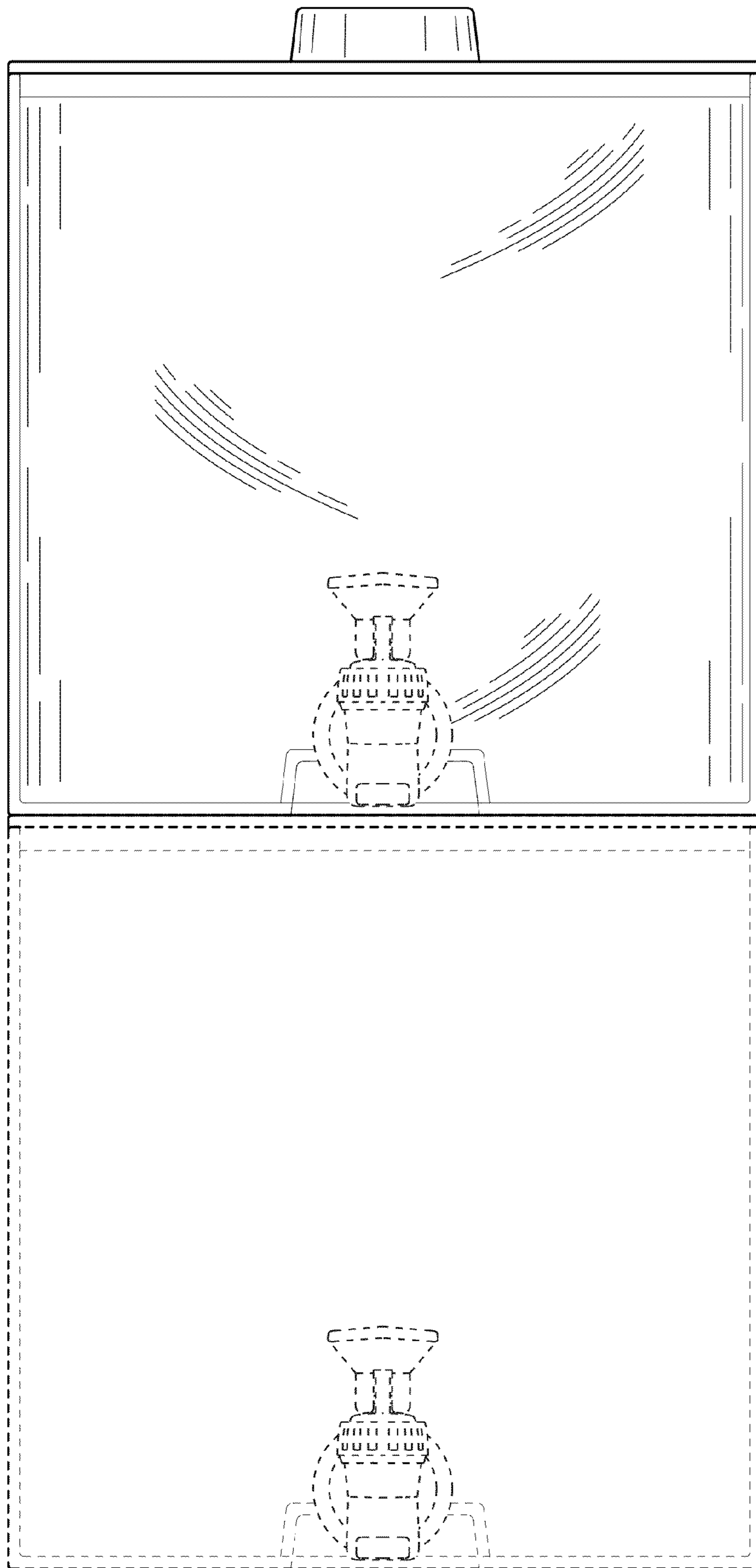

FIG. 8

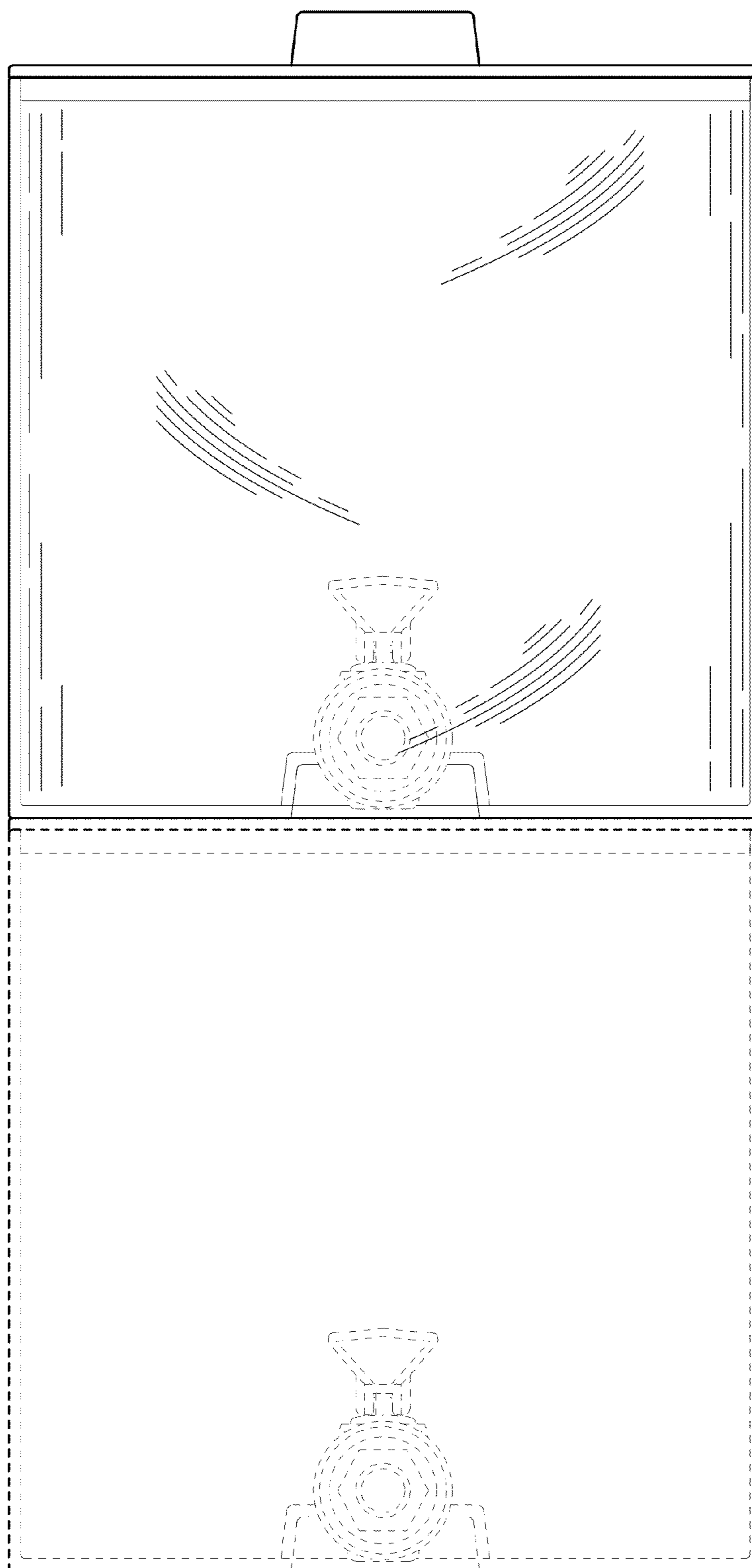

FIG. 9

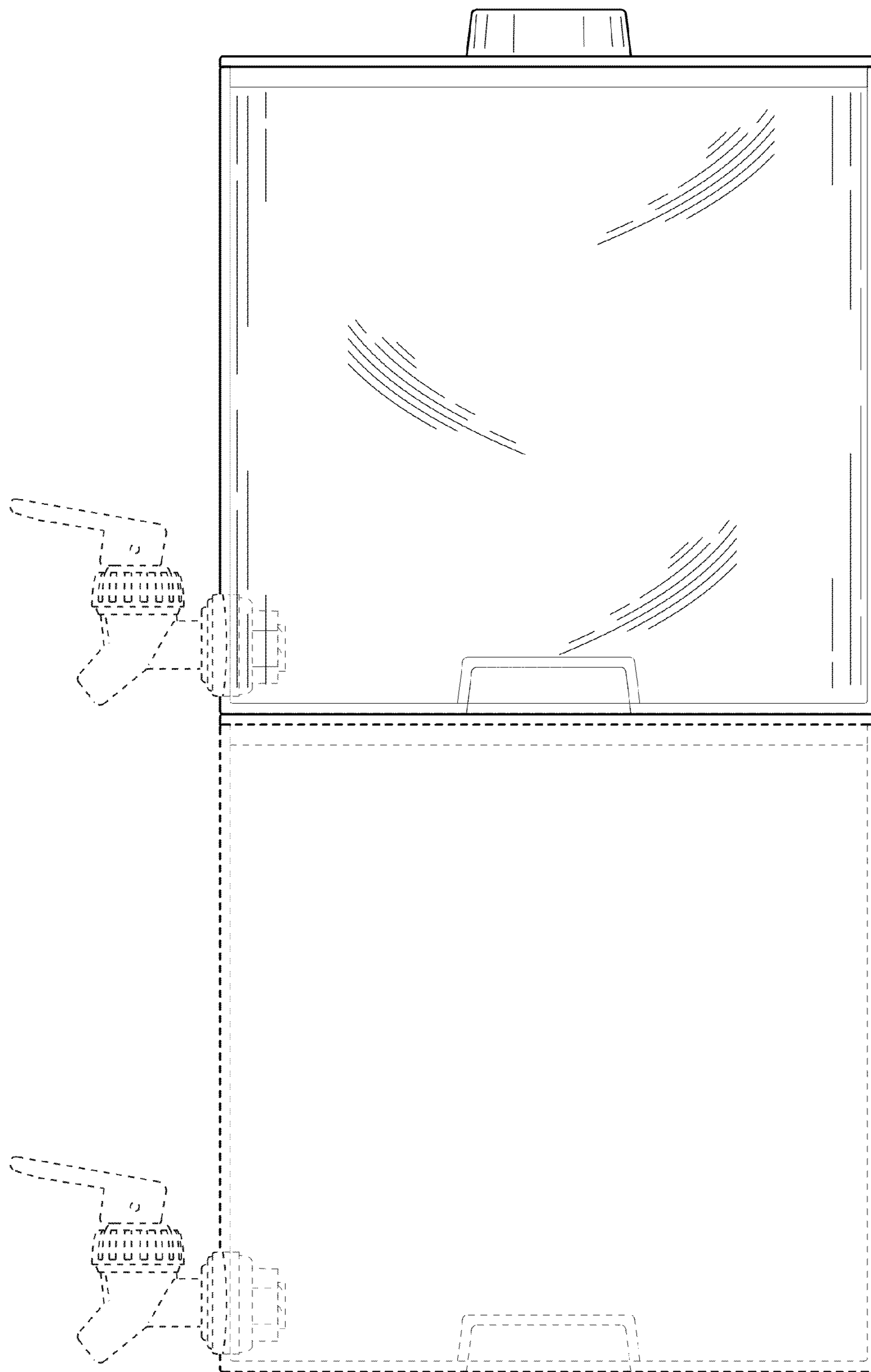
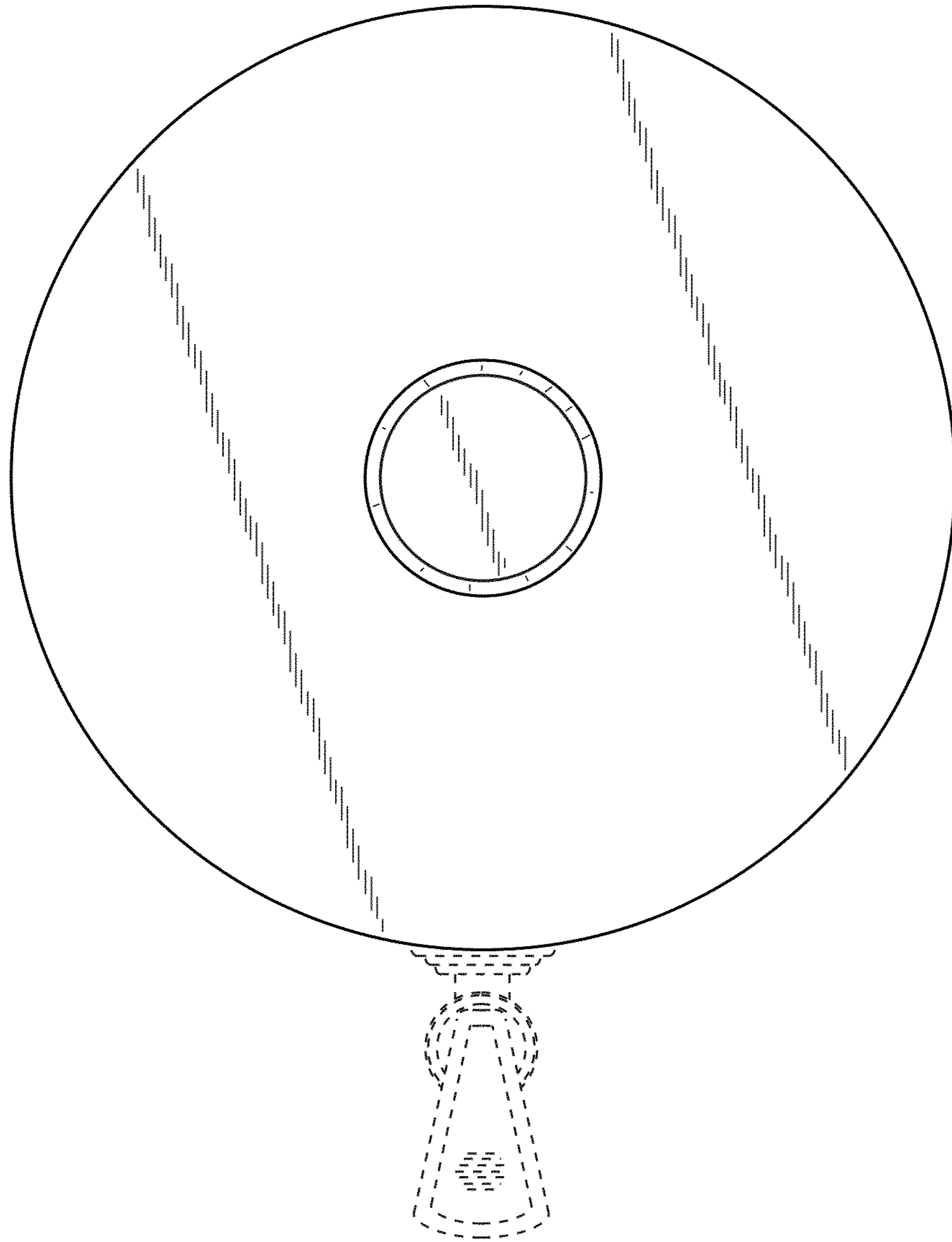
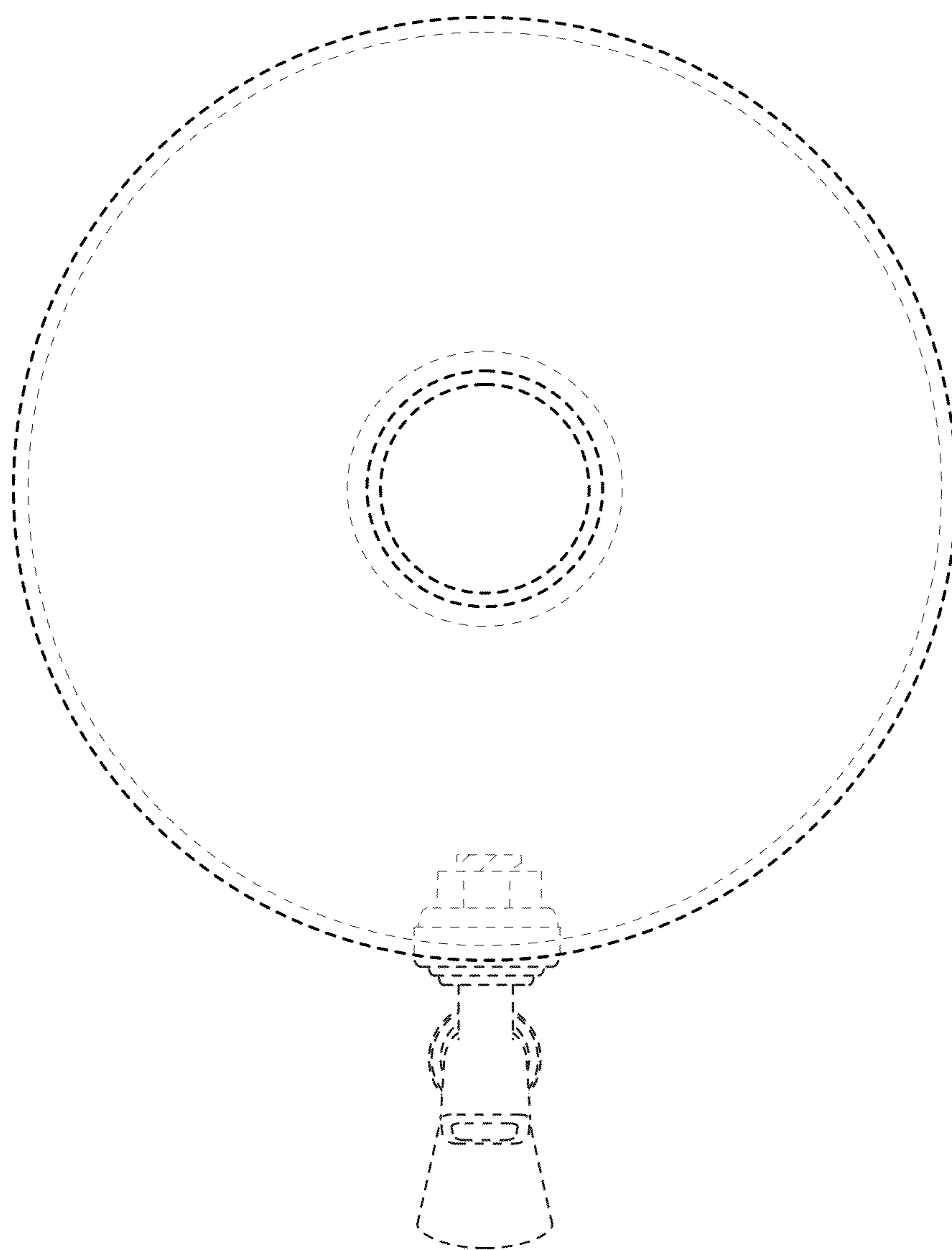

FIG. 10



**FIG. 11**



**FIG. 12**