



US00D685590S

(12) **United States Design Patent**
Hale et al.

(10) **Patent No.:** **US D685,590 S**
(45) **Date of Patent:** **** Jul. 9, 2013**

(54) **GARMENT AND ACCESSORIES ORGANIZER**

D499,548 S * 12/2004 Deutschendorf et al. D3/278
D619,834 S * 7/2010 Koller et al. D6/514
D666,440 S * 9/2012 Kinskey et al. D6/514

(71) Applicants: **Susan Jean Hale**, Brooklyn, NY (US);
Mieke Katherine Malmberg, Los Angeles, CA (US)

* cited by examiner

(72) Inventors: **Susan Jean Hale**, Brooklyn, NY (US);
Mieke Katherine Malmberg, Los Angeles, CA (US)

Primary Examiner — Brian N Vinson

(73) Assignee: **Go For It Designs, LLC**, Los Angeles, CA (US)

(57) **CLAIM**

The ornamental design for a garment and accessories organizer, as shown and described.

(**) Term: **14 Years**

DESCRIPTION

(21) Appl. No.: **29/441,027**

FIG. 1 is a front perspective view of an embodiment of a garment and accessories organizer, embodying our new design.

(22) Filed: **Dec. 31, 2012**

FIG. 2 is a front plan view of the same organizer.

(51) **LOC (9) Cl.** **06-06**

FIG. 3 is a left side plan view thereof.

(52) **U.S. Cl.**

FIG. 4 is a back plan view thereof.

USPC **D6/514; D3/278**

FIG. 5 is a right side plan view thereof, which is a mirror image of FIG. 3.

(58) **Field of Classification Search**

USPC D6/512-514, 524-525, 552-553, D6/567-570, 315, 317-320, 323, 326; D3/201, D3/203.1, 205, 903, 278; 206/730, 214, 575, 206/579, 581, 38, 6.1, 278-279, 287-289, 206/291; 211/13.1, 10, 85.2, 85.3, 85.7, 35, 211/41.12, 70.6, 86.01, 87.01; 248/300, 304, 248/309.1, 317; 383/23, 40, 121; 190/107, 190/109, 11, 112, 113

FIG. 6 is a top plan view of thereof.

FIG. 7 is a bottom plan view thereof.

FIG. 8 is a perspective view of the same organizer when it is folded.

FIG. 9 is a front view of the same organizer when it is folded.

FIG. 10 is a left side view of the same organizer when it is folded.

FIG. 11 is a back view of the organizer when it is folded.

FIG. 12 is a right side view of the same organizer when it is folded.

FIG. 13 is a top view of the same organizer when it is folded.

FIG. 14 is a bottom view of the same organizer when it is folded; and,

FIG. 15 is a back perspective view of the same organizer showing the lengthwise zipper when it is open.

The broken lines and hash patterns in the figures depict environmental structures and do not form a part of the claimed design.

See application file for complete search history.

(56) **References Cited**

U.S. PATENT DOCUMENTS

D256,636 S * 9/1980 Leishman D6/315
D320,115 S * 9/1991 King D3/278
D435,727 S * 1/2001 Gordon D3/278

1 Claim, 11 Drawing Sheets

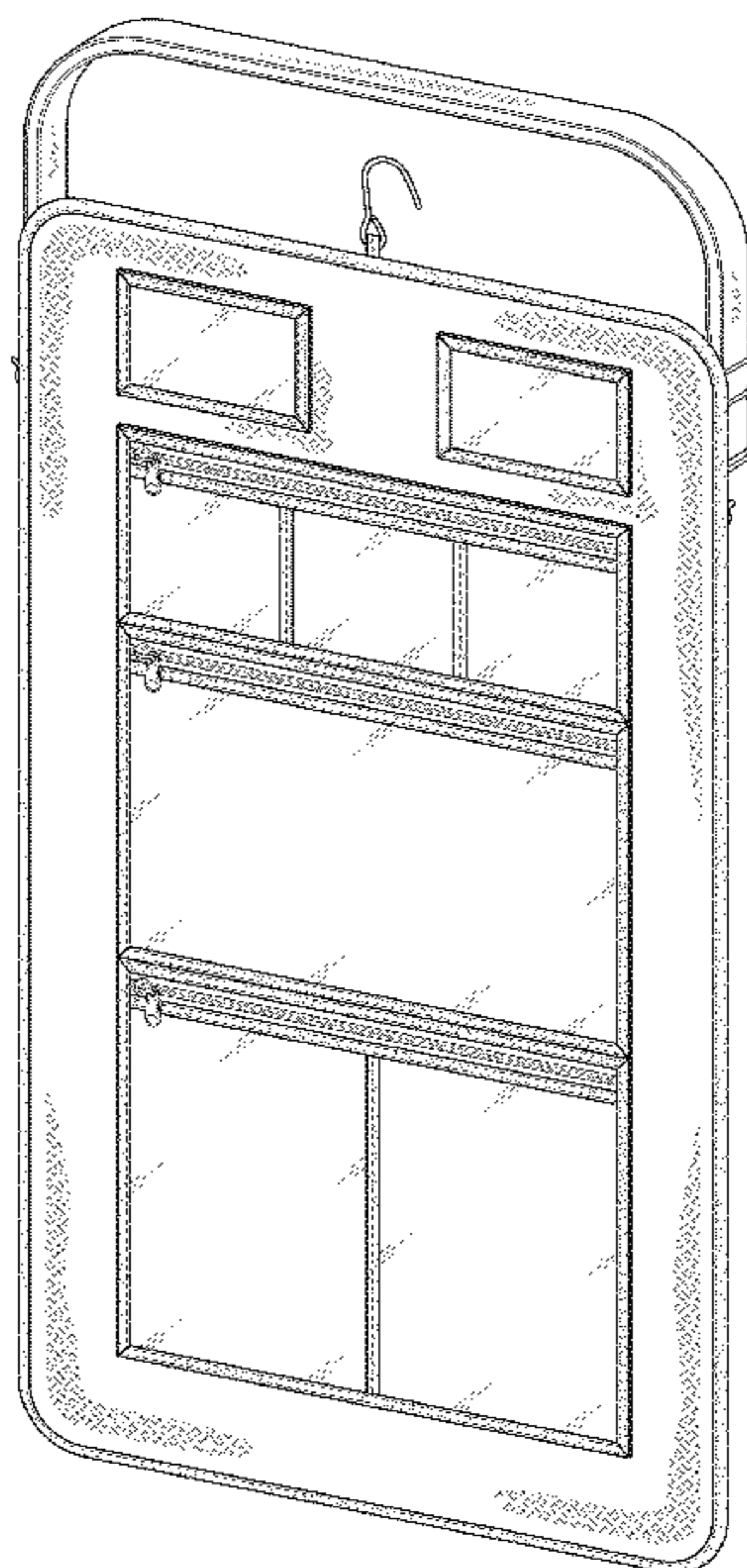

FIG. 1

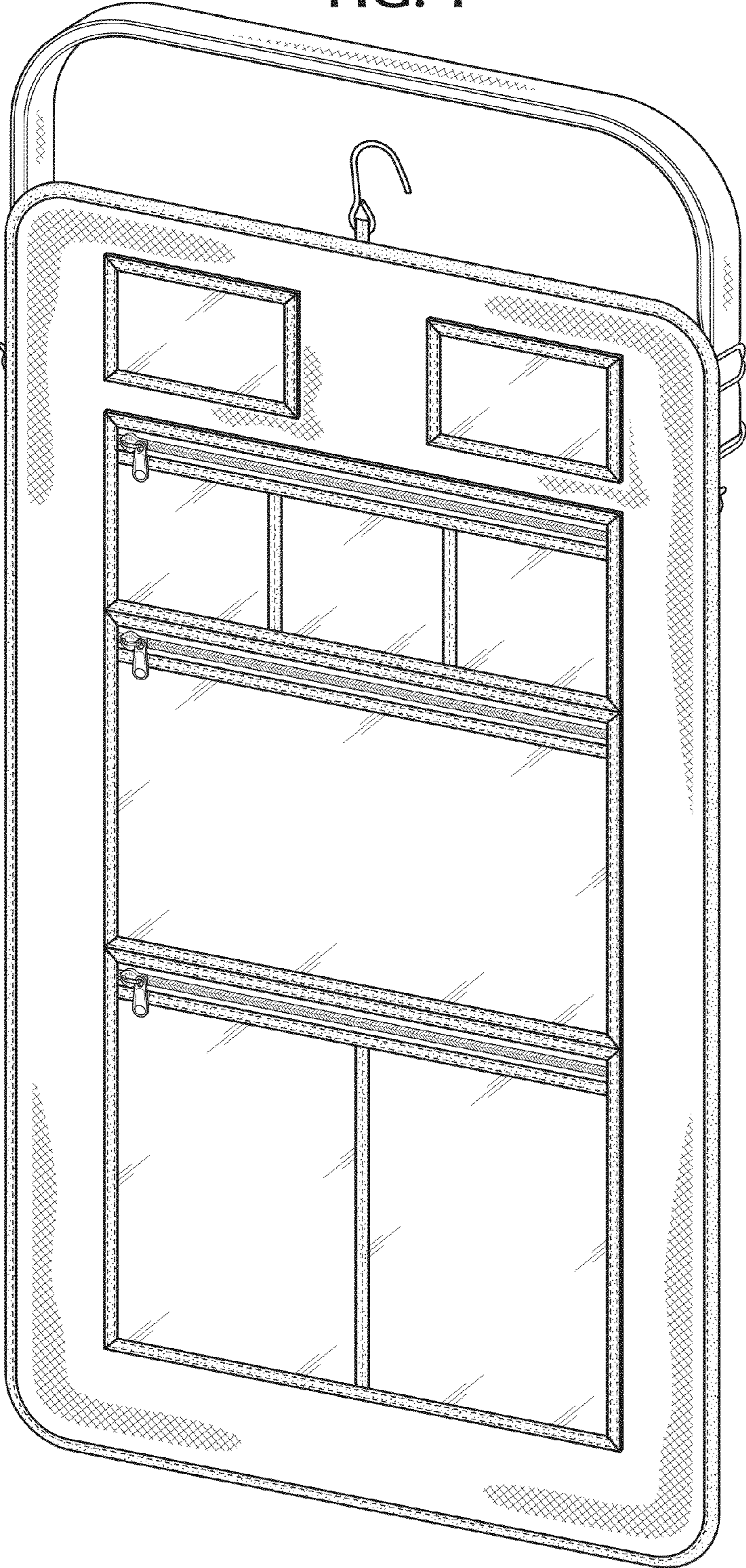

FIG. 2

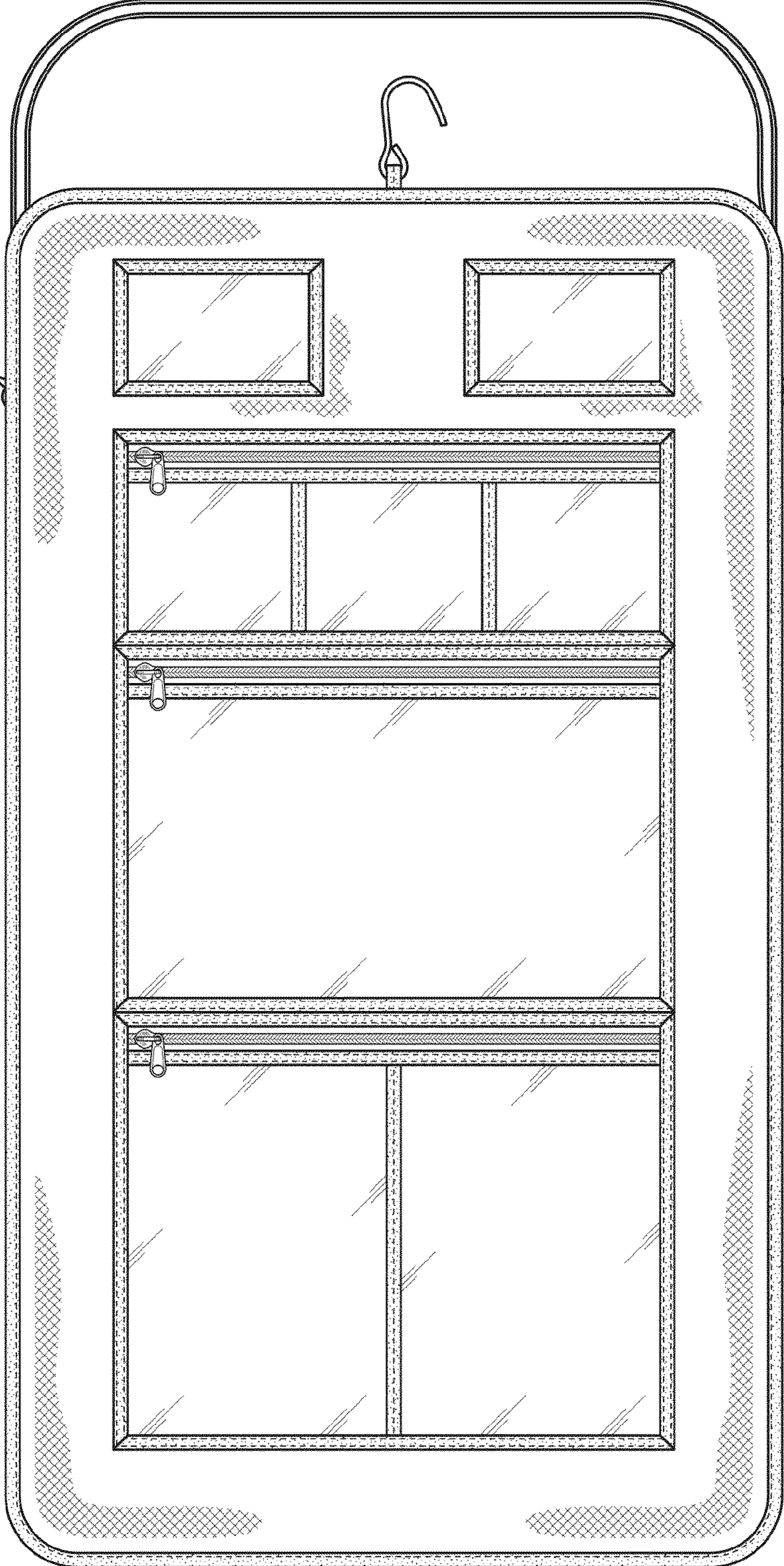

FIG. 3

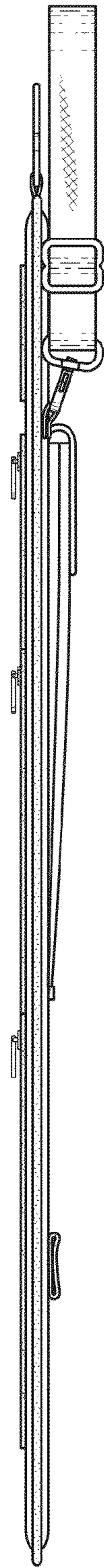

FIG. 5

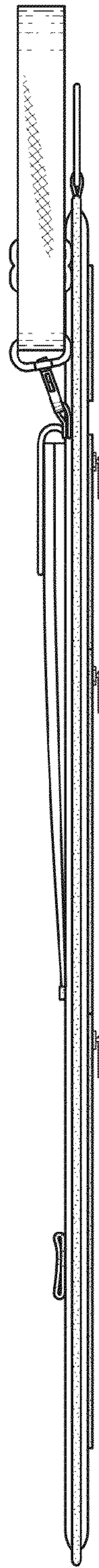
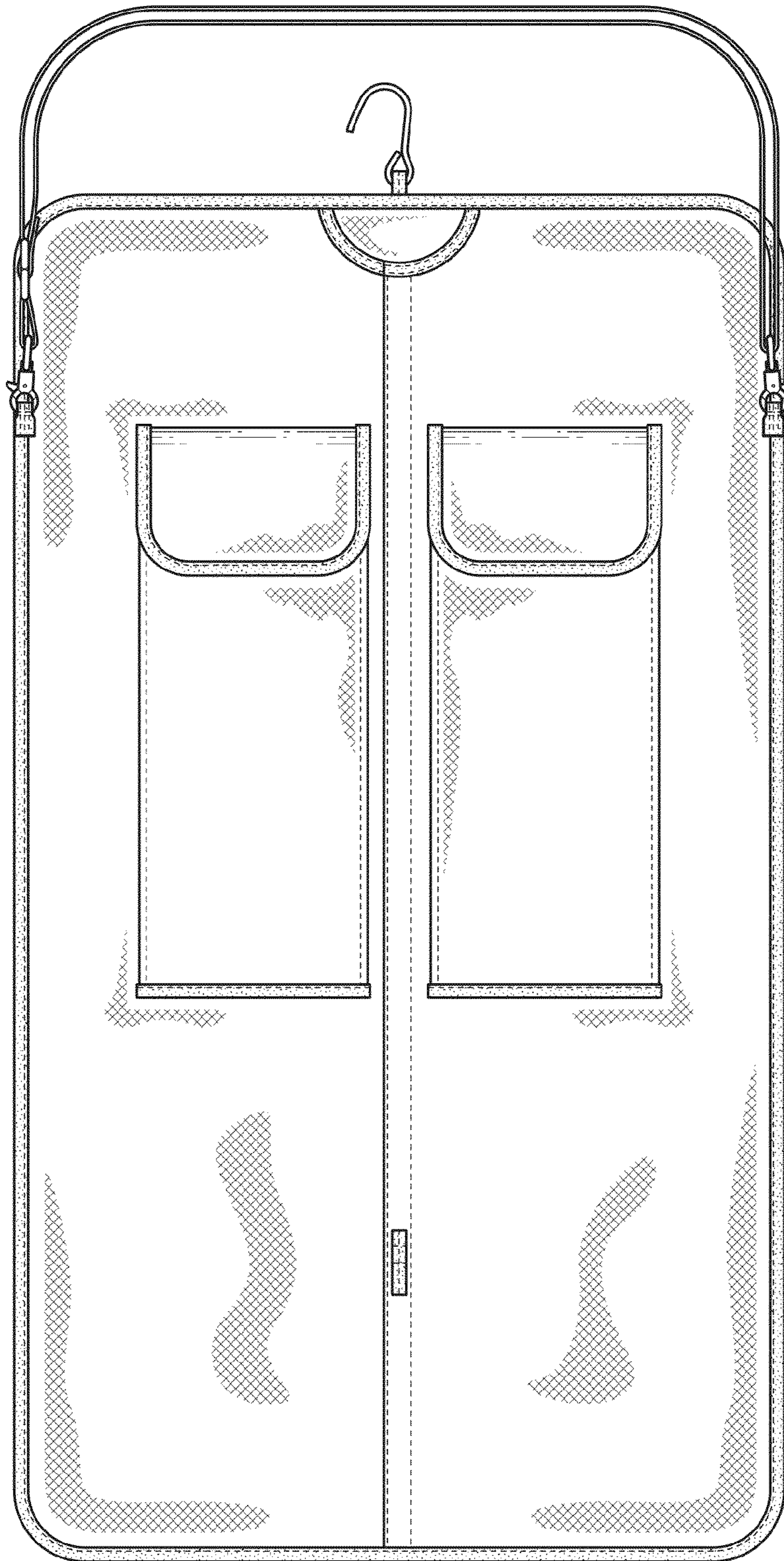

FIG. 4



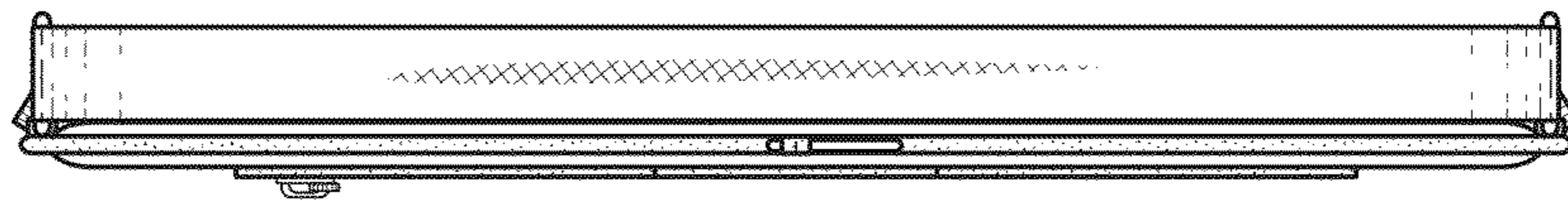

FIG. 6

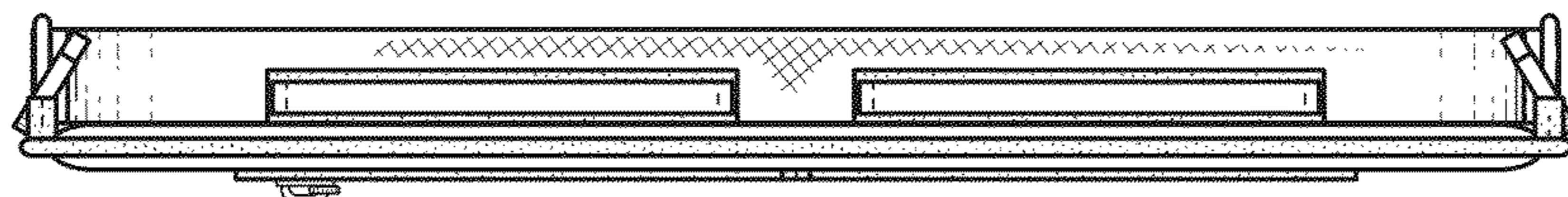

FIG. 7

FIG. 8

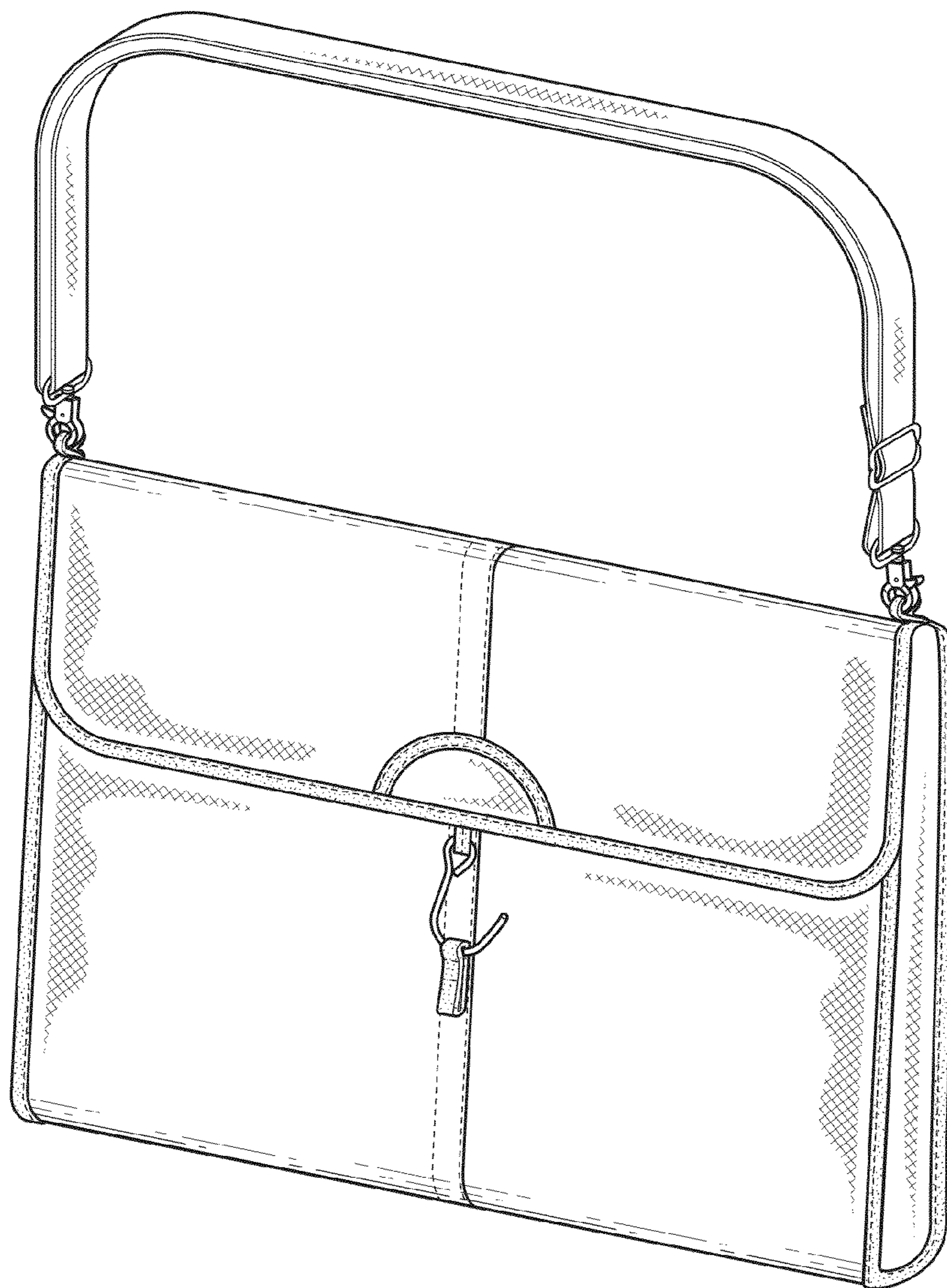

FIG. 9

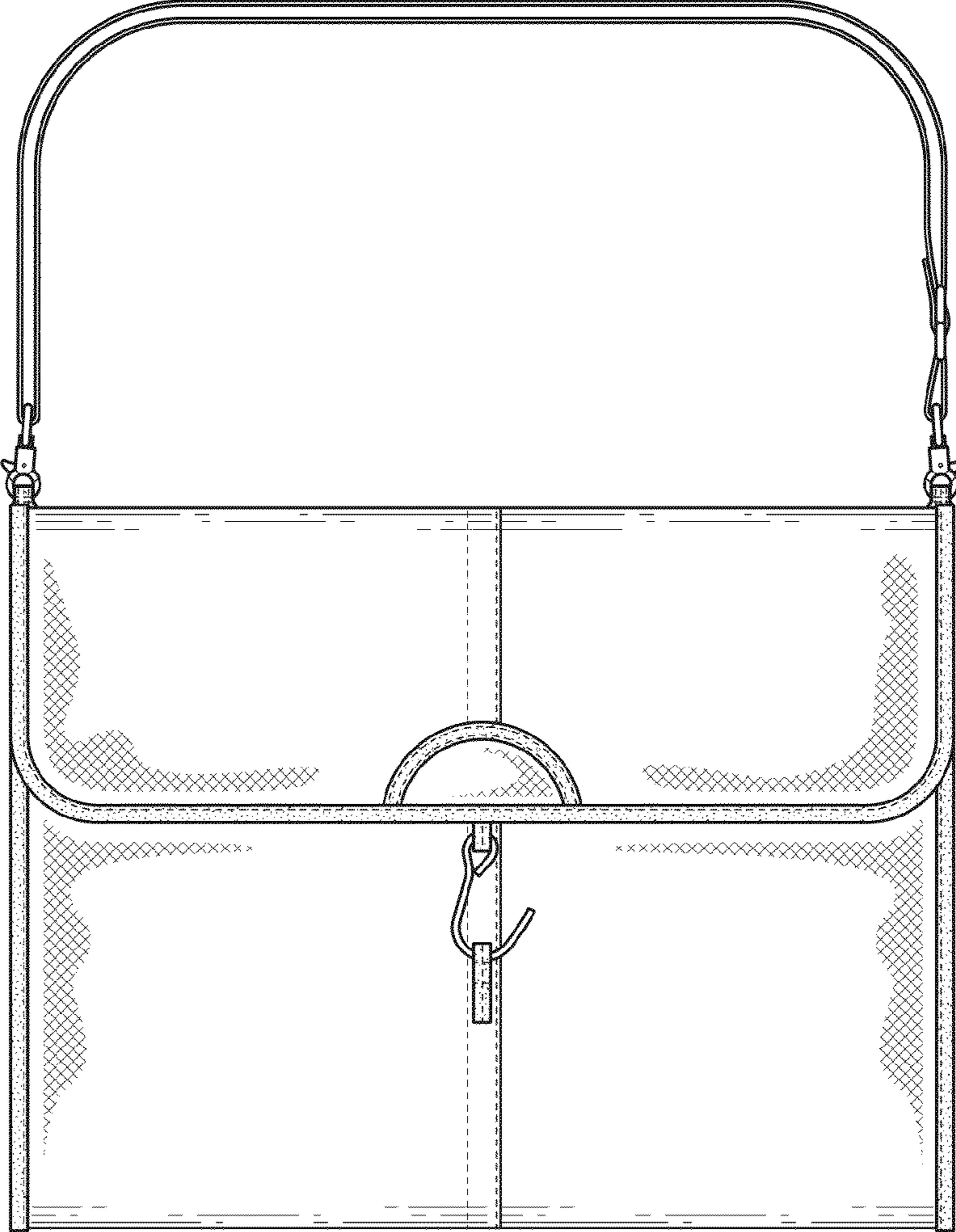

FIG. 10

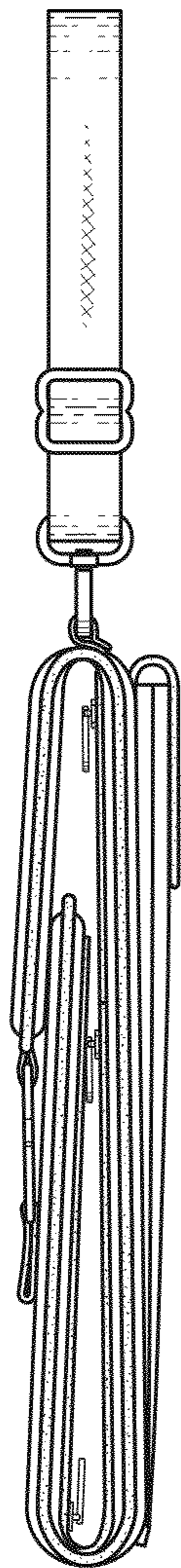

FIG. 12

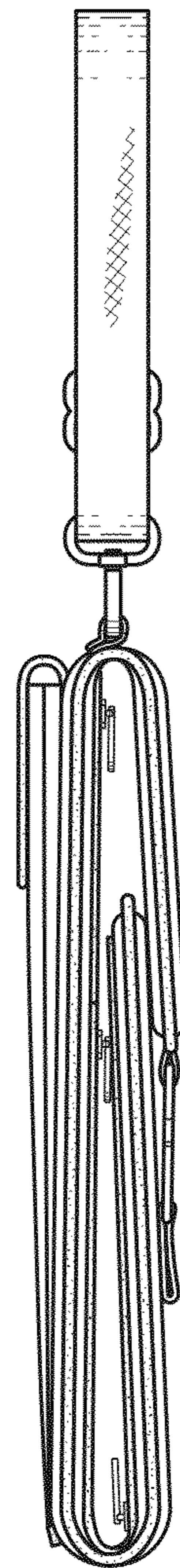
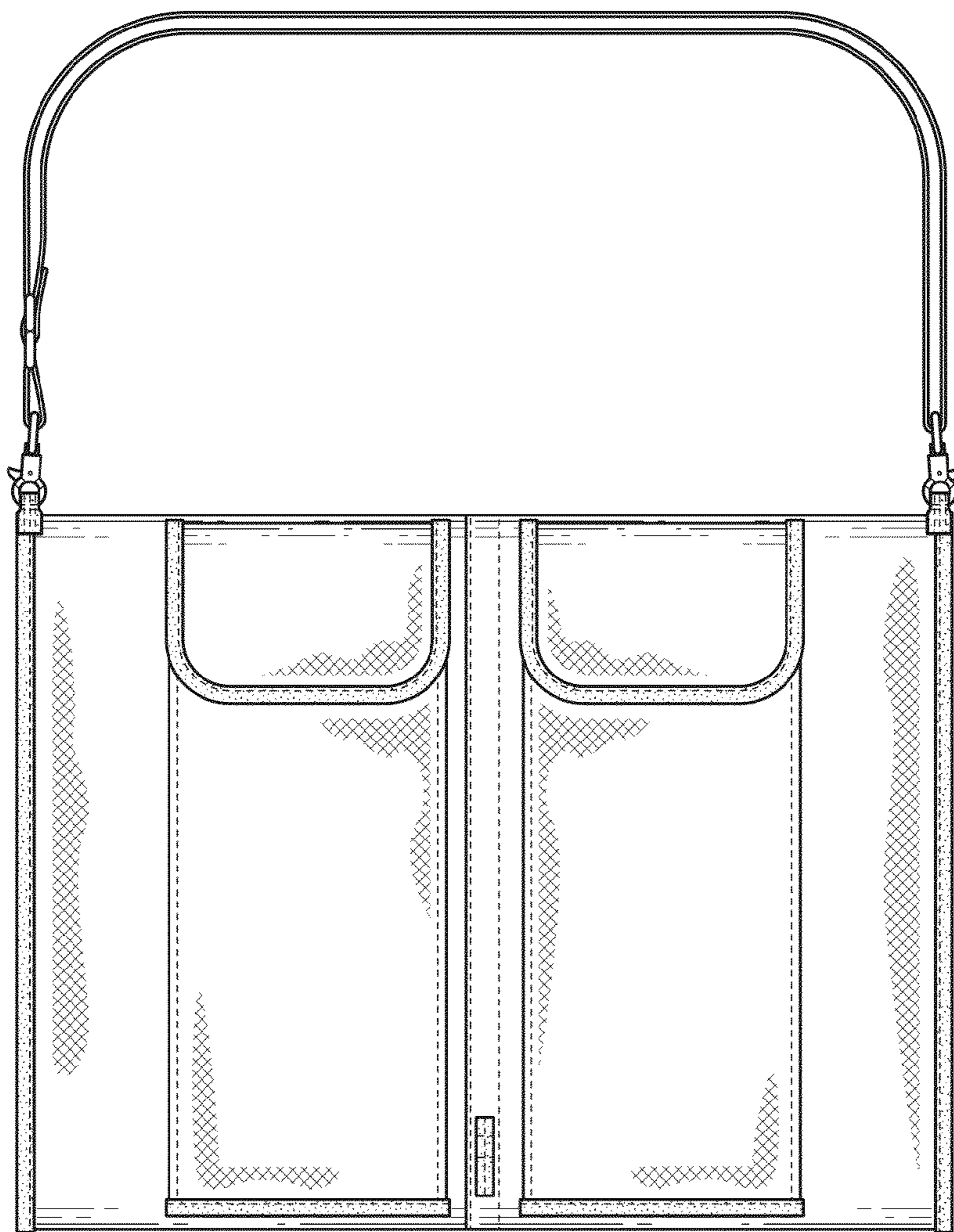

FIG. 11



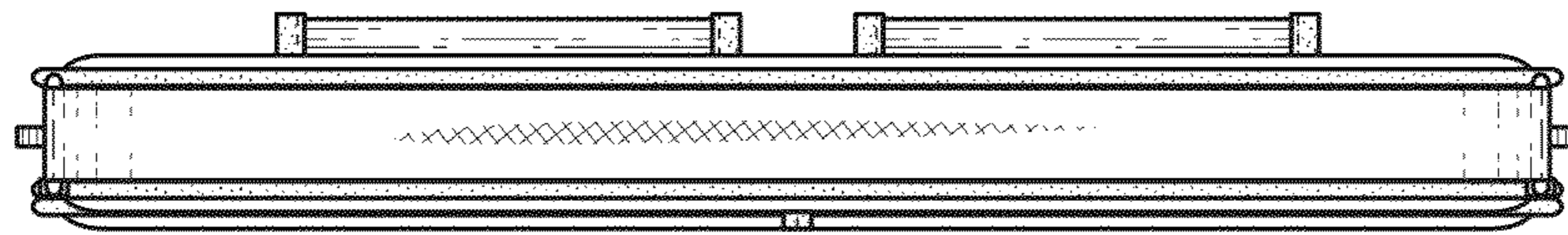

FIG. 13

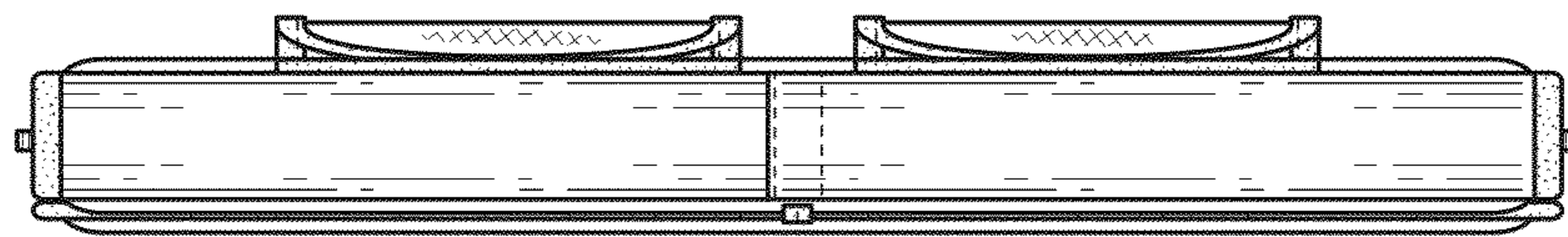

FIG. 14

FIG. 15

