



US00D685588S

(12) **United States Design Patent**
Stukenberg et al.

(10) **Patent No.:** **US D685,588 S**
(45) **Date of Patent:** **** Jul. 9, 2013**

(54) **DISPLAY UNIT**

D244,889 S 7/1977 Neuschwander
4,154,027 A 5/1979 Searcy
D257,995 S 1/1981 Mikkelson et al.

(75) Inventors: **Joseph R. Stukenberg**, Minneapolis, MN (US); **Scott Denby**, Minneapolis, MN (US)

(Continued)

(73) Assignee: **Target Brands, Inc.**, Minneapolis, MN (US)

OTHER PUBLICATIONS

U.S. Appl. No. 29/358,811, filed Apr. 1, 2010 (8 Pages).

(**) Term: **14 Years**

(Continued)

(21) Appl. No.: **29/412,129**

Primary Examiner — Ricky Pham

(22) Filed: **Jan. 31, 2012**

(74) *Attorney, Agent, or Firm* — Griffiths & Seaton PLLC; JoAnn M. Seaton

(51) **LOC (9) Cl.** **06-04**

(57) **CLAIM**

(52) **U.S. Cl.**

The ornamental design for a display unit, as shown and described.

USPC **D6/436**

(58) **Field of Classification Search**

DESCRIPTION

USPC D3/302; D6/300, 309, 396, 436–439, D6/444–448, 460–468, 470–479, 491–495, D6/509–511, 559, 561, 660–661, 662.1, 671, D6/671.1, 672–675, 675.1, 678.4, 705.5; D19/75; 211/42–50, 90.01, 133.1, 186–189; 312/50, 107–109, 117–119, 122, 194, 198, 312/204–209, 224–234, 242, 245, 278–279

FIG. 1 is a front, perspective view of a display unit showing a first embodiment of our new design; FIG. 2 is a front view thereof; FIG. 3 is a right side view thereof; FIG. 4 is a left side view thereof; and FIG. 5 is a top view thereof.

See application file for complete search history.

FIG. 6 is a front, perspective view of the display unit of FIG. 1 with additional environmental subject matter shown in broken lines; FIG. 7 is a front view thereof; FIG. 8 is a right side view thereof; FIG. 9 is a left side view thereof; and, FIG. 10 is a top view thereof.

(56) **References Cited**

U.S. PATENT DOCUMENTS

810,243 A	1/1906	Wright	
839,639 A	12/1906	Pulfer	
870,314 A	11/1907	Pierce	
1,435,395 A	11/1922	Howard	
1,528,243 A	3/1925	Briggs	
1,647,889 A	11/1927	Saunders	
1,766,409 A	6/1930	Stocks	
1,861,671 A	6/1932	Webb	
2,171,378 A	8/1939	Urbanek	
2,285,962 A	6/1942	Foulkes	
3,716,281 A	2/1973	Rudder, Jr.	
D242,192 S	11/1976	Robinson	
D243,981 S *	4/1977	Carter D6/446

The features shown in broken lines depict environmental subject matter only and form no part of the claimed design. Bolded, long dash-short dash lines indicate the boundaries of the claimed subject matter and otherwise form no part of the claimed design. The rear and bottom views have been omitted from the application, as those surfaces are not part of the claimed design.

1 Claim, 10 Drawing Sheets

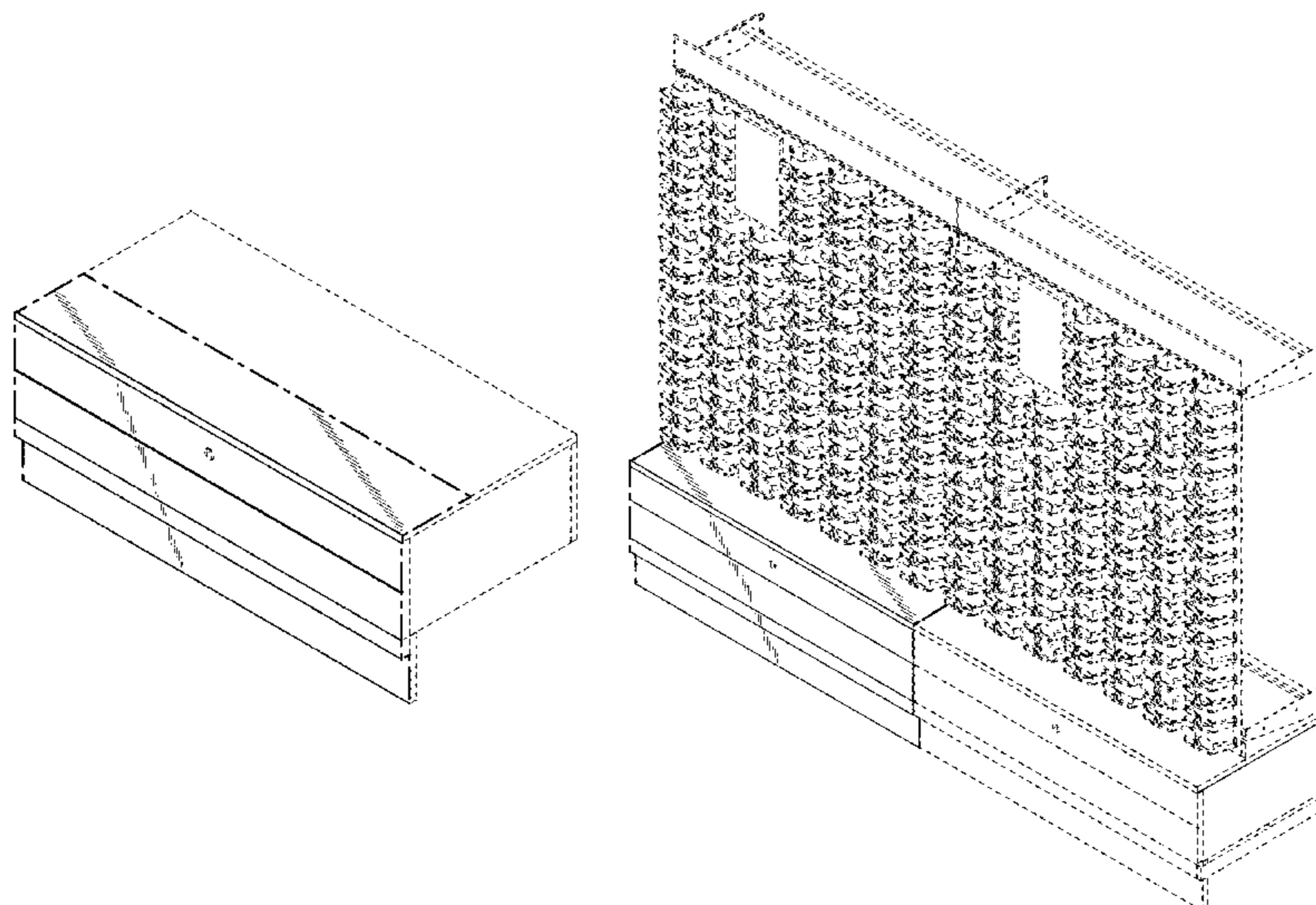

US D685,588 S

Page 2

U.S. PATENT DOCUMENTS

4,288,948 A 9/1981 Harris
D267,293 S 12/1982 Georgi
D273,923 S * 5/1984 Matthias D6/445
5,447,366 A * 9/1995 Cole 312/50
5,529,192 A * 6/1996 Conen et al. 211/189
D401,443 S * 11/1998 Zaidman D6/446
D410,620 S 6/1999 Sacco et al.
D426,033 S 5/2000 Rooks
D429,085 S 8/2000 Welty et al.
D450,486 S 11/2001 Stafford et al.
D461,061 S 8/2002 Kent
D547,569 S * 7/2007 Yan D6/474
D573,369 S * 7/2008 Sparkowski D6/463
D584,078 S * 1/2009 Weigand D6/473
D586,584 S * 2/2009 Hung D6/470
D587,494 S * 3/2009 Cramer D6/470
D599,577 S * 9/2009 Lara D6/436
D609,937 S * 2/2010 Ricereto D6/432
D611,733 S 3/2010 Stukenberg
D611,734 S 3/2010 Stukenberg et al.
D611,735 S 3/2010 Stukenberg

D617,558 S 6/2010 Myers
D622,976 S * 9/2010 Lovegrove D6/446
D637,421 S * 5/2011 Theisen et al. D6/478
D641,988 S * 7/2011 Giroux D6/396
D649,192 S * 11/2011 Beukema et al. D19/75
D653,475 S * 2/2012 Thompson D6/437
D654,719 S * 2/2012 Stukenberg D6/418
D655,108 S * 3/2012 Majrani D6/479
D657,591 S * 4/2012 Sanchez D6/479
D657,978 S * 4/2012 Hamm et al. D6/470
D675,020 S * 1/2013 Mu et al. D3/302
2002/0084726 A1 * 7/2002 O'Neill et al. 312/122
2005/0230338 A1 * 10/2005 Farinola et al. 211/186
2009/0188875 A1 * 7/2009 Wade et al. 211/45

OTHER PUBLICATIONS

U.S. Appl. No. 29/393,744, filed Jun. 8, 2011 (35 pages).
U.S. Appl. No. 13/096,879, filed Apr. 28, 2011 (33 pages).
U.S. Appl. No. 13/268,244, filed Oct. 7, 2011 (42 pages).
U.S. Appl. No. 29/412,193, filed Jan. 31, 2012 (13 pages).

* cited by examiner

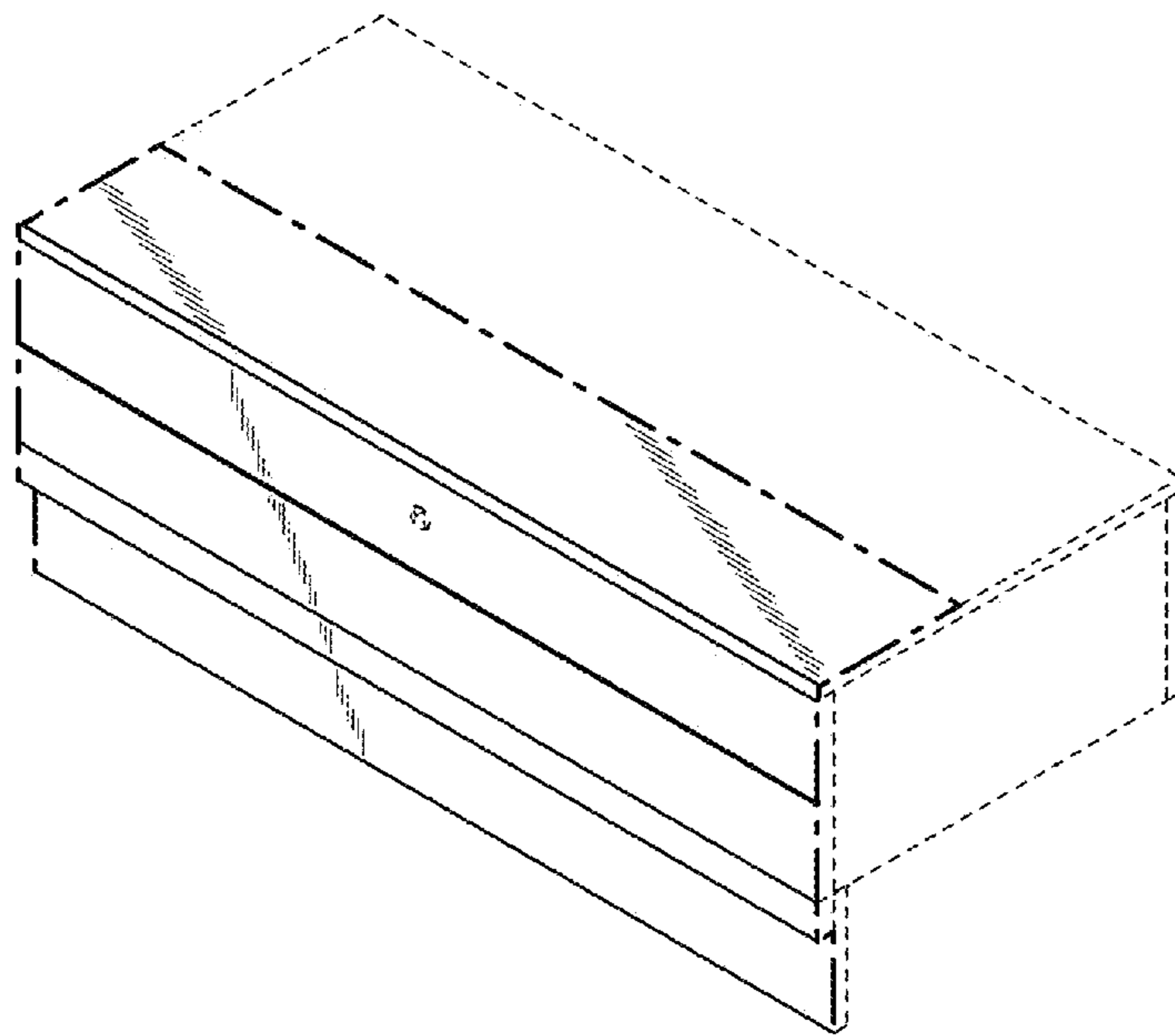

FIG. 1

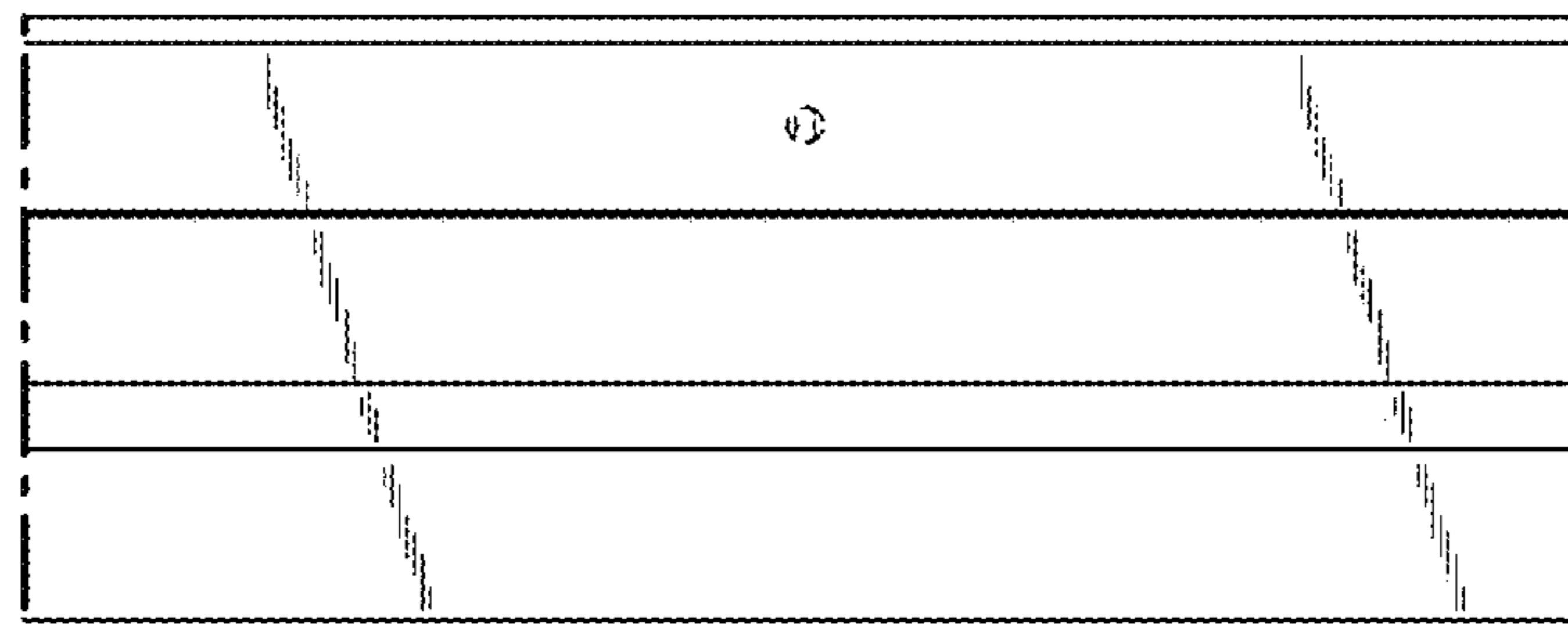

FIG. 2

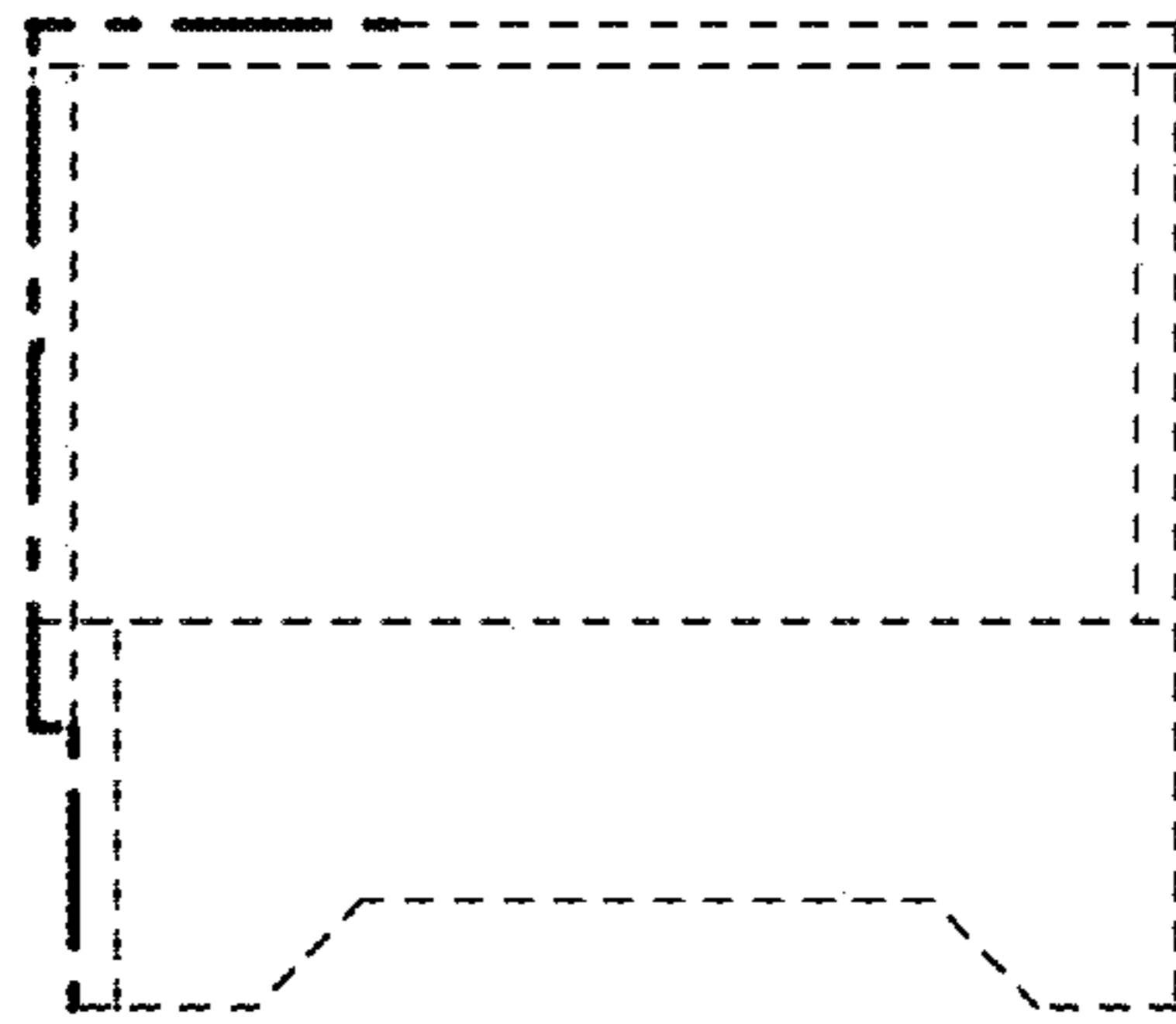

FIG. 3

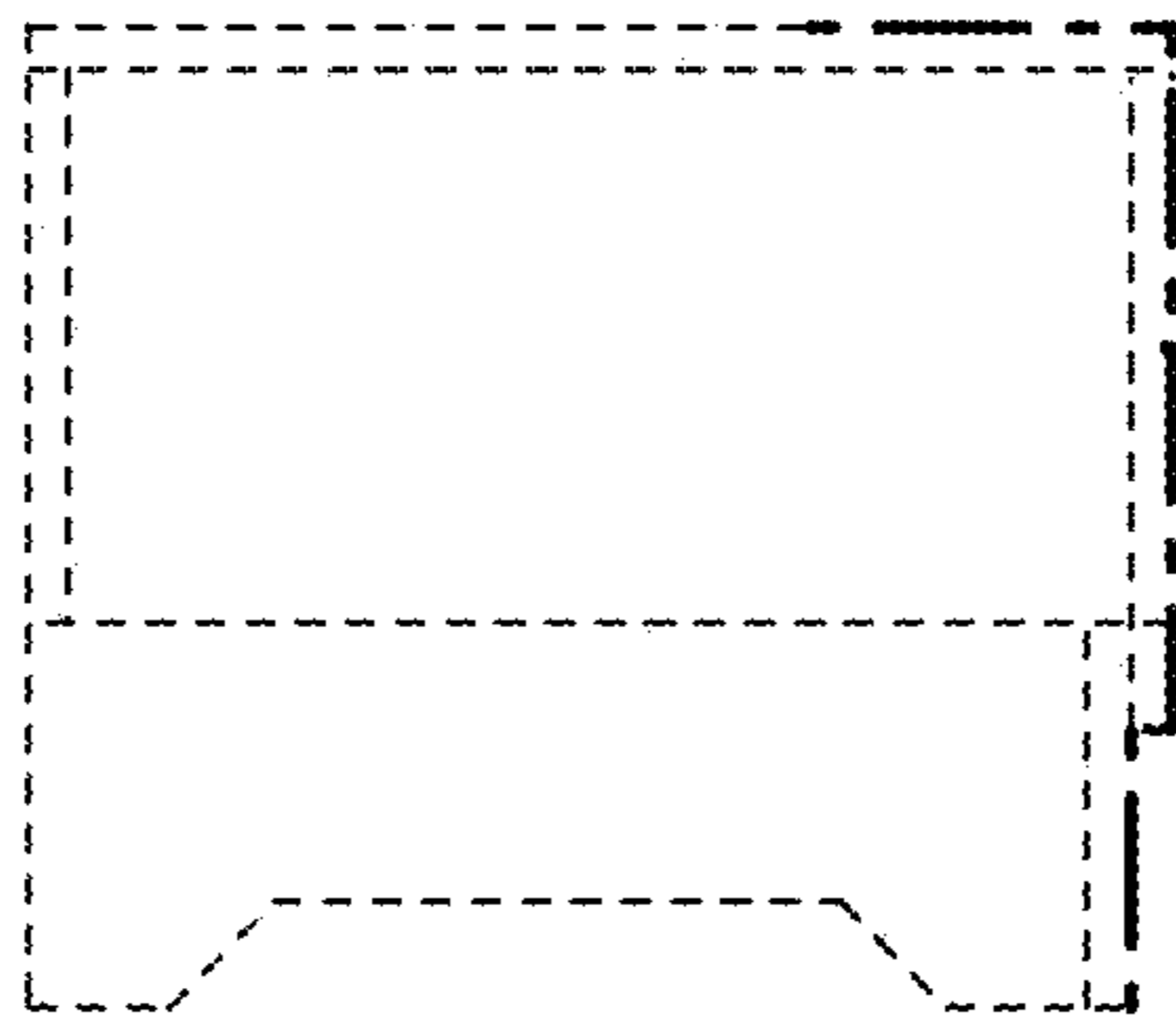

FIG. 4

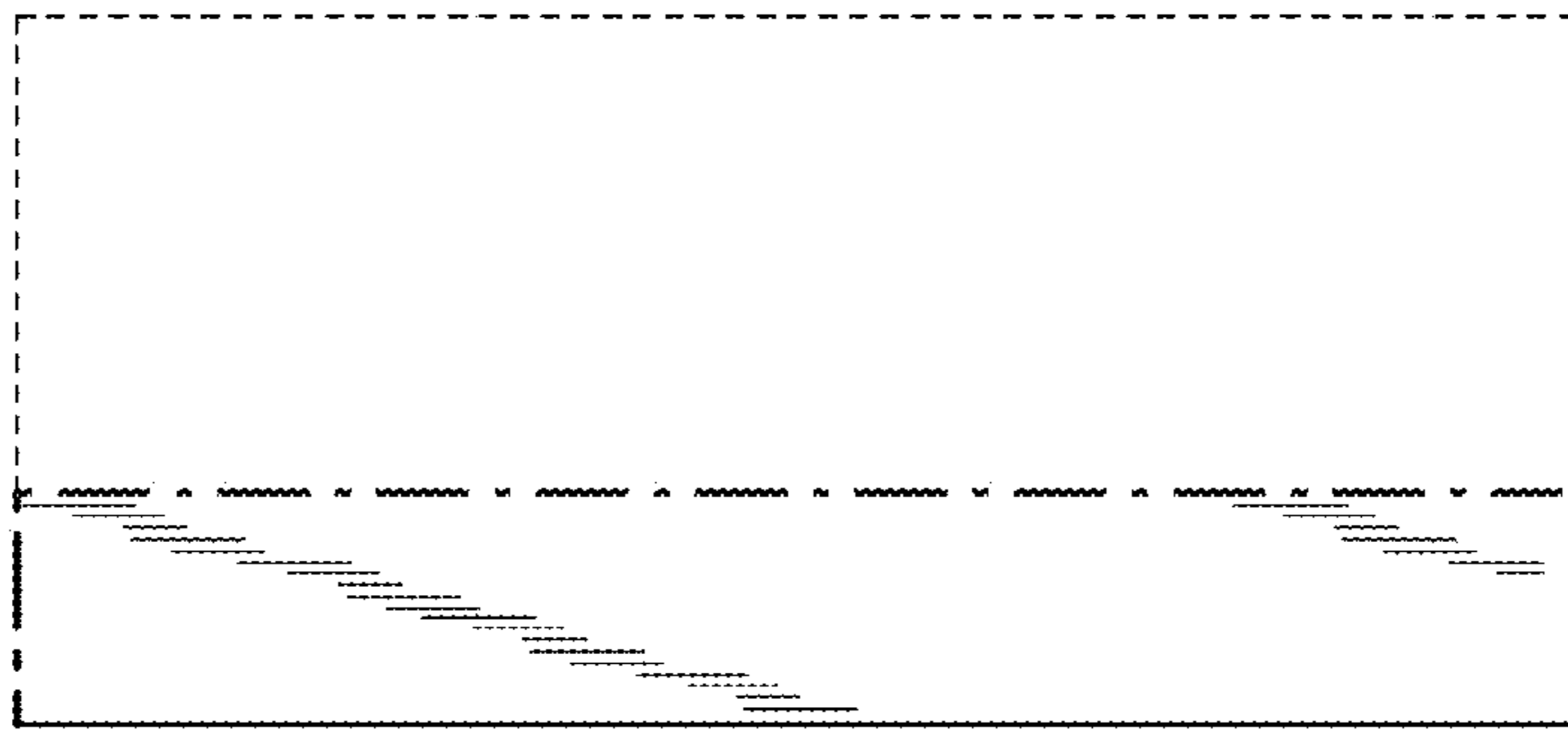

FIG. 5

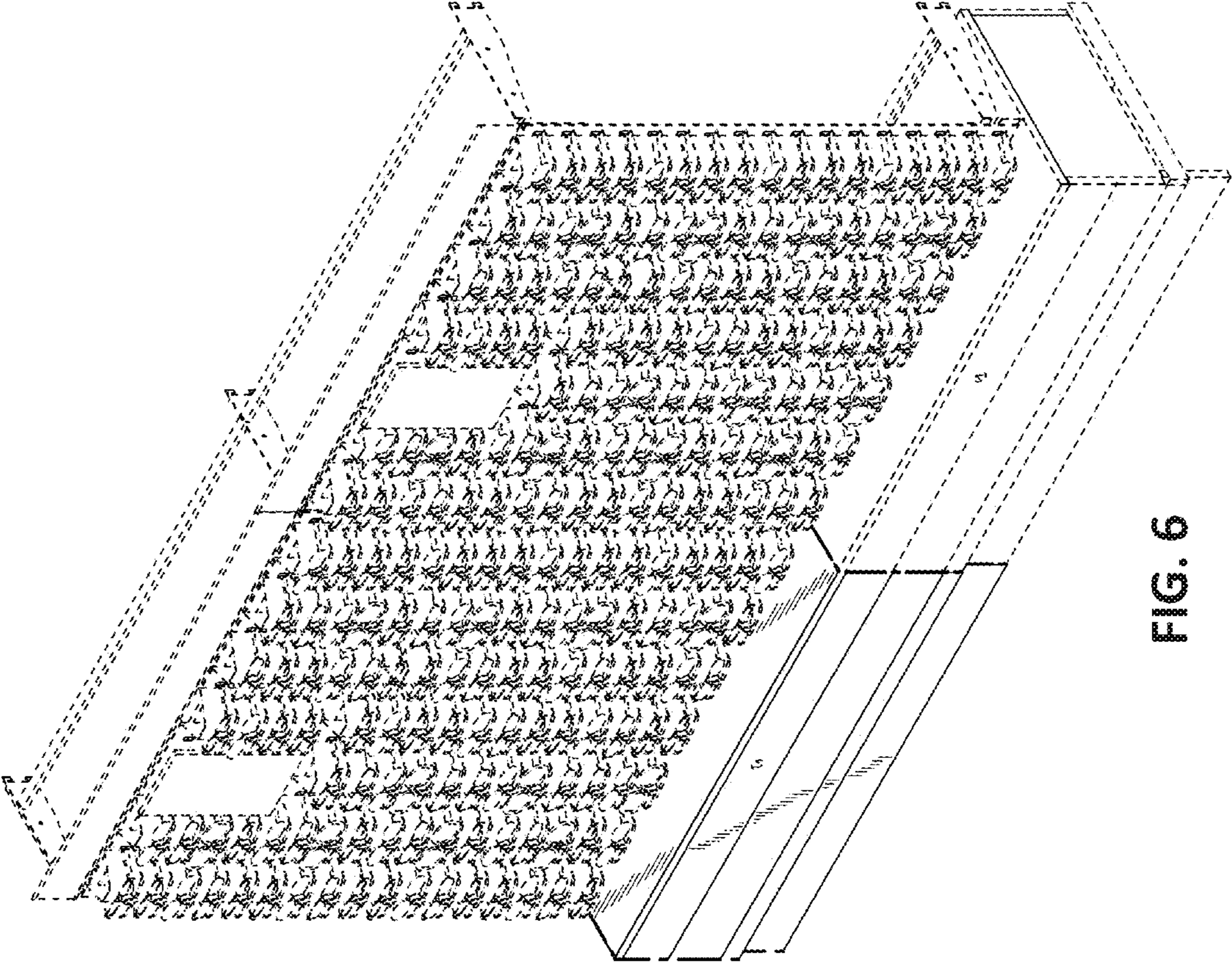

FIG. 6

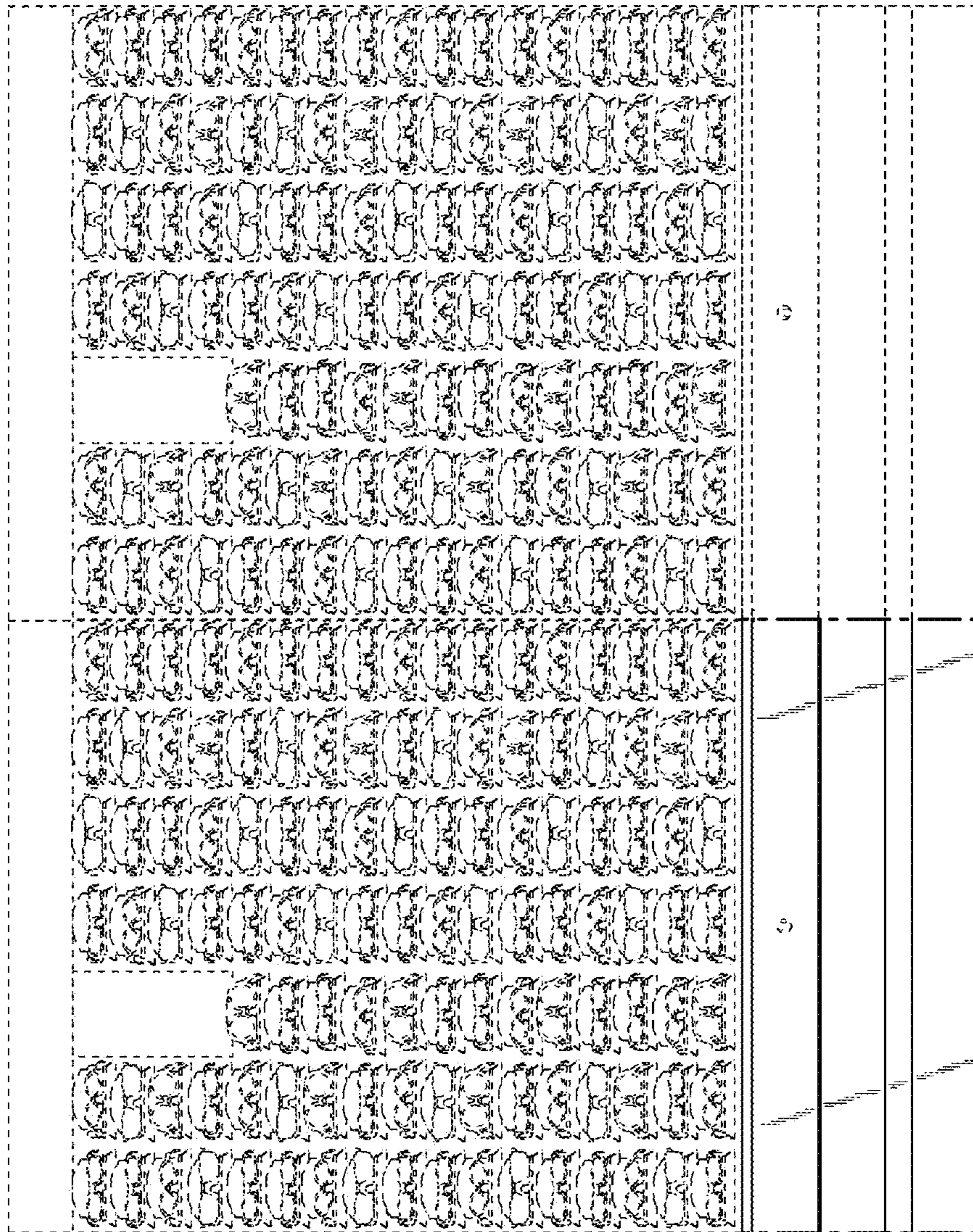

FIG. 7

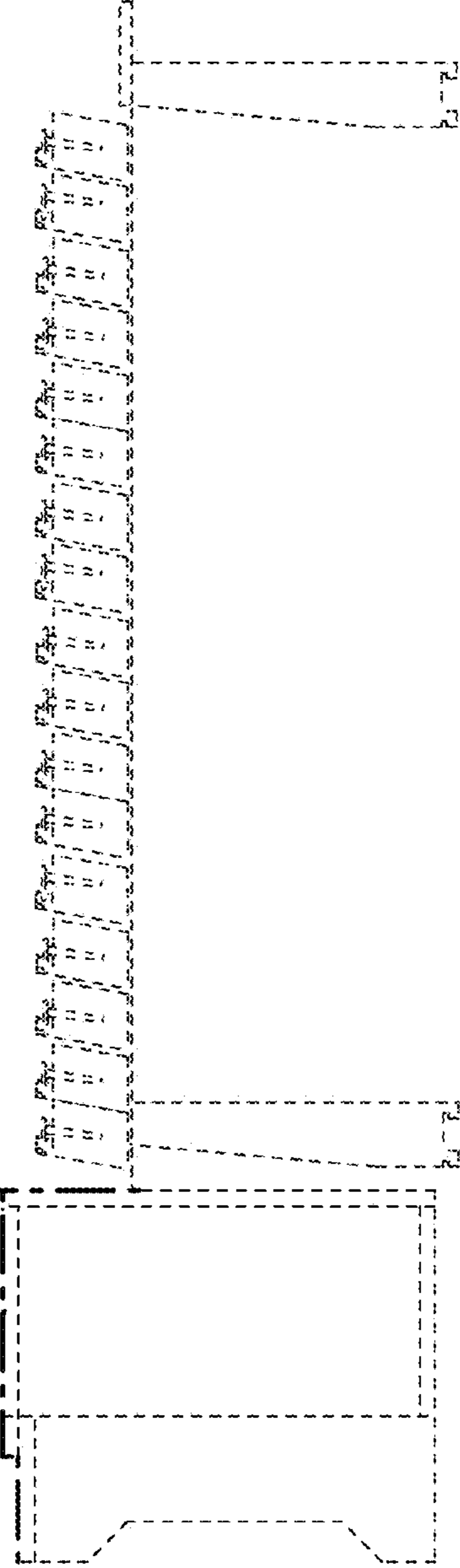

FIG. 8

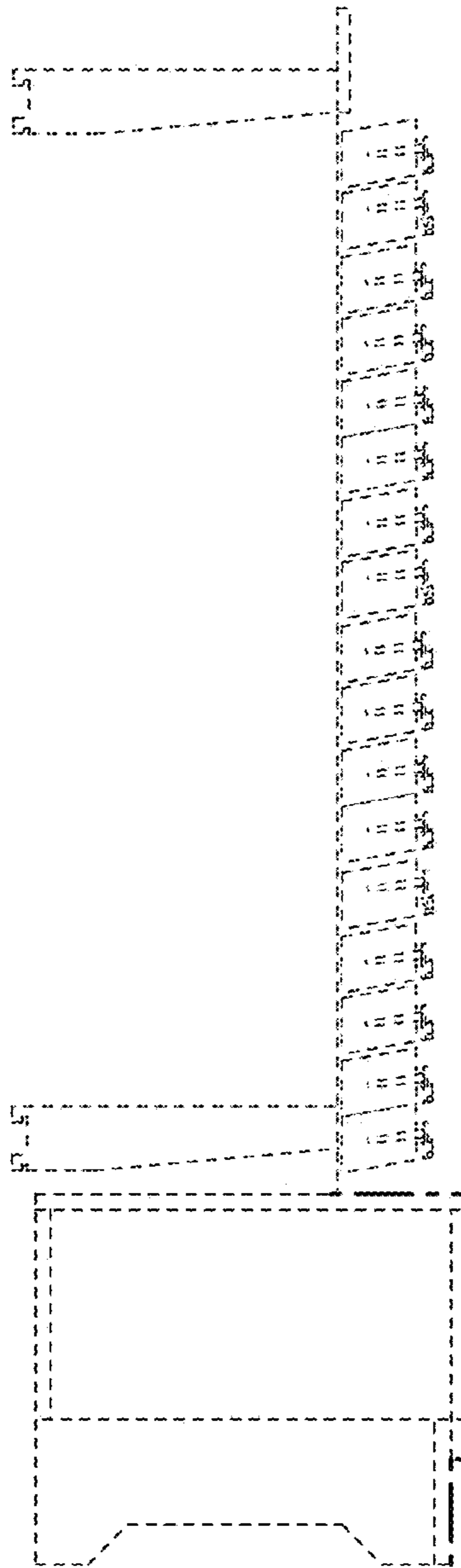

FIG. 9

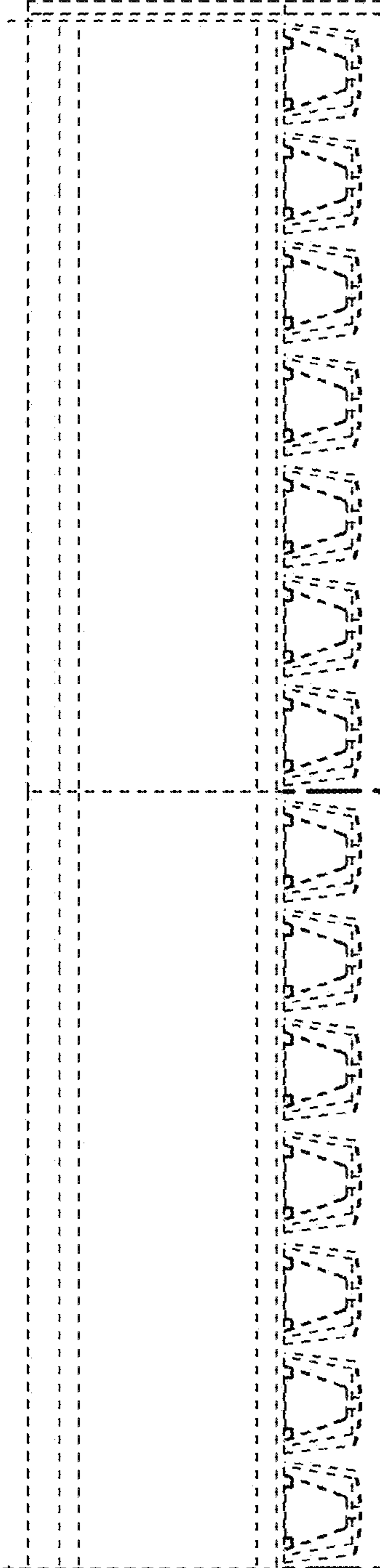

FIG. 10