



US00D685556S

(12) **United States Design Patent**
Fields

(10) **Patent No.:** **US D685,556 S**
(45) **Date of Patent:** **** Jul. 2, 2013**

(54) **PORTABLE CLEANING DEVICE**
(76) Inventor: **Blaine Alan Fields**, Santa Monica, CA
(US)
(**) Term: **14 Years**
(21) Appl. No.: **29/422,088**
(22) Filed: **May 16, 2012**

7,617,560 B2 11/2009 Argo et al.
7,766,258 B2 8/2010 Barniak, Jr.
D640,432 S * 6/2011 Jackson D32/42
2005/0005949 A1 1/2005 Boggess
2006/0029458 A1 2/2006 Jones
2006/0115316 A1 6/2006 Verlin
2009/0185851 A1 7/2009 Mapalo et al.

FOREIGN PATENT DOCUMENTS

GB 917564 2/1963
* cited by examiner

Related U.S. Application Data

(63) Continuation-in-part of application No. 13/012,370,
filed on Jan. 24, 2011.
(51) **LOC (9) Cl.** **04-01**
(52) **U.S. Cl.**
USPC **D32/42**
(58) **Field of Classification Search**
USPC D32/40-46; 15/245; 401/118, 119
See application file for complete search history.

Primary Examiner — Robin V Webster

(74) *Attorney, Agent, or Firm* — Heidi L. Eisenhut; Loza &
Loza LLP

(57) **CLAIM**

The ornamental design for a portable cleaning device, as
shown and described.

DESCRIPTION

FIG. 1 is a right side perspective view of a portable cleaning
device of the present invention;
FIG. 2 is left side perspective view of the portable cleaning
device of FIG. 1;
FIG. 3 is front elevation view of the portable cleaning device
of FIG. 1;
FIG. 4 is a back elevation view of the portable cleaning device
of FIG. 1;
FIG. 5 is a right elevation view the portable cleaning device of
FIG. 1;
FIG. 6 is a left elevation view the portable cleaning device of
FIG. 1;
FIG. 7 is a top plan view of the portable cleaning device of
FIG. 1; and,
FIG. 8 is a bottom plan view of the portable cleaning device of
FIG. 1.

(56) **References Cited**

U.S. PATENT DOCUMENTS

57,656 A 9/1866 Alden
3,724,017 A 4/1973 Mallory
4,143,792 A 3/1979 Rex
4,312,093 A 1/1982 Raab
4,759,470 A 7/1988 Jacobs
4,903,869 A 2/1990 McKenna
D409,342 S * 5/1999 Kajimoto et al. D32/40
6,007,129 A 12/1999 Kearney, Jr.
6,036,388 A * 3/2000 Atcher 401/118
6,135,276 A 10/2000 French et al.
6,227,737 B1 5/2001 Lightfoot
6,301,740 B1 10/2001 Quiroz
6,360,884 B1 3/2002 Smith et al.
6,758,331 B2 7/2004 DeHart
6,854,910 B2 2/2005 Leblanc
7,311,458 B2 12/2007 Verlin

1 Claim, 8 Drawing Sheets

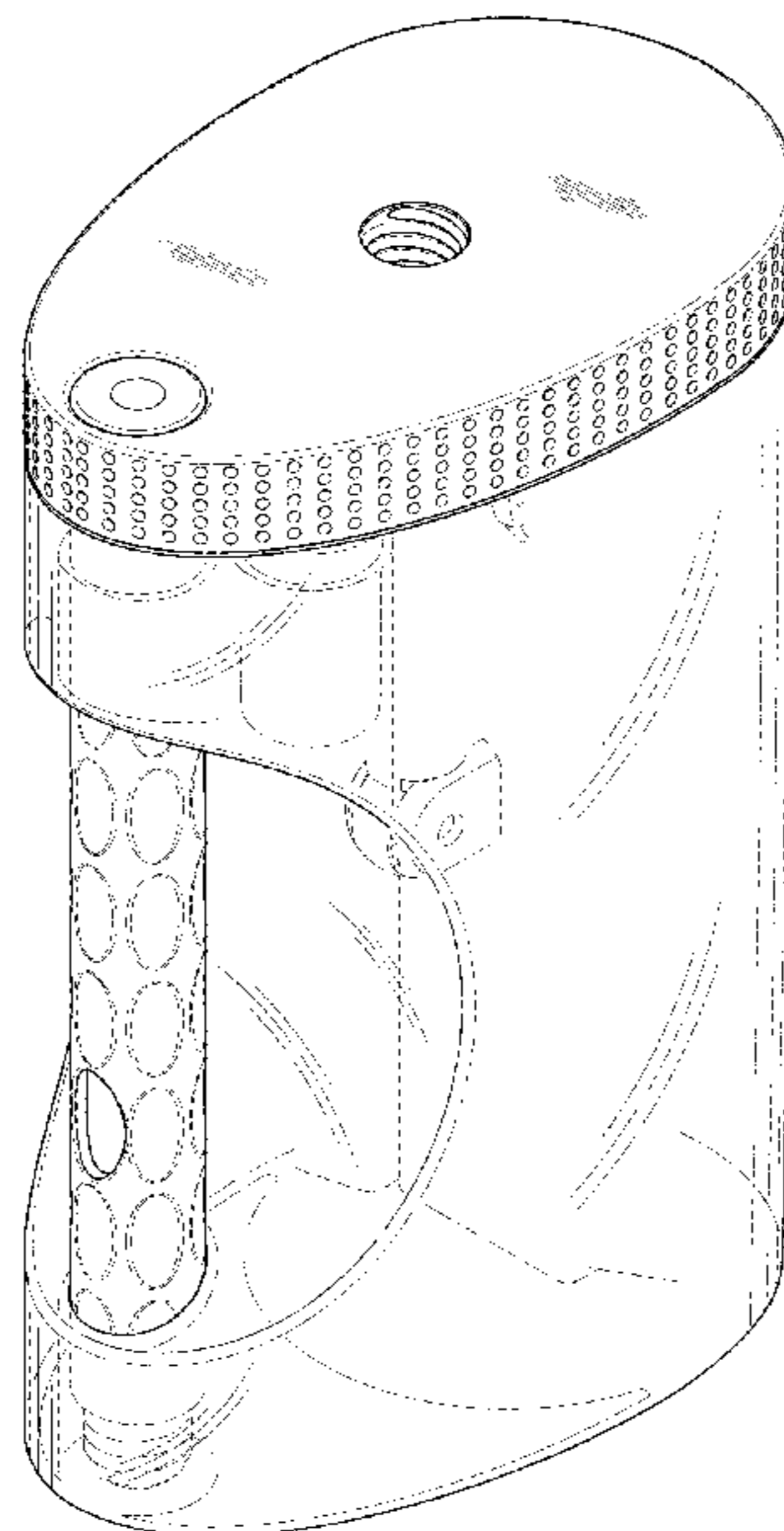

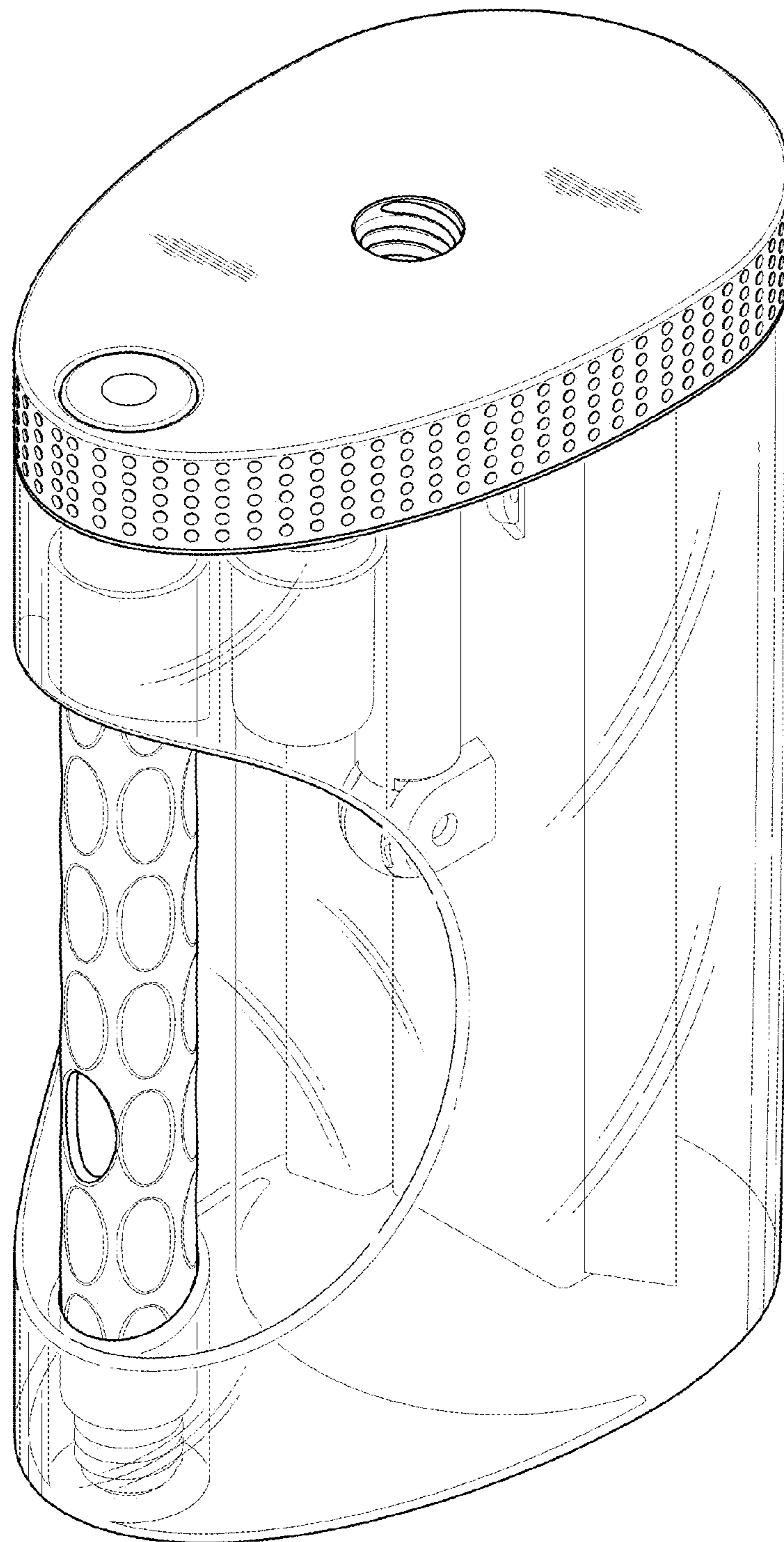

FIG. 1

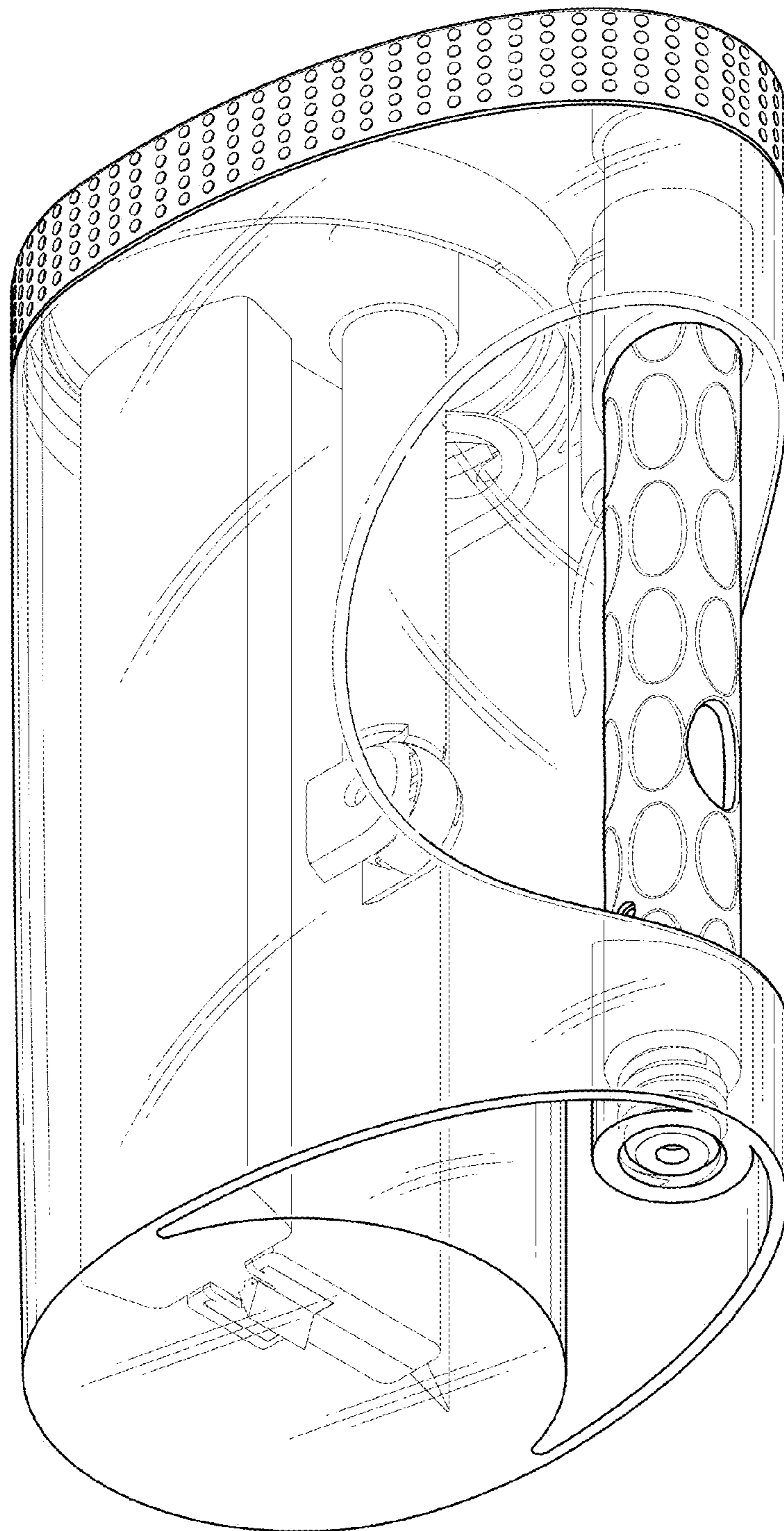

FIG. 2

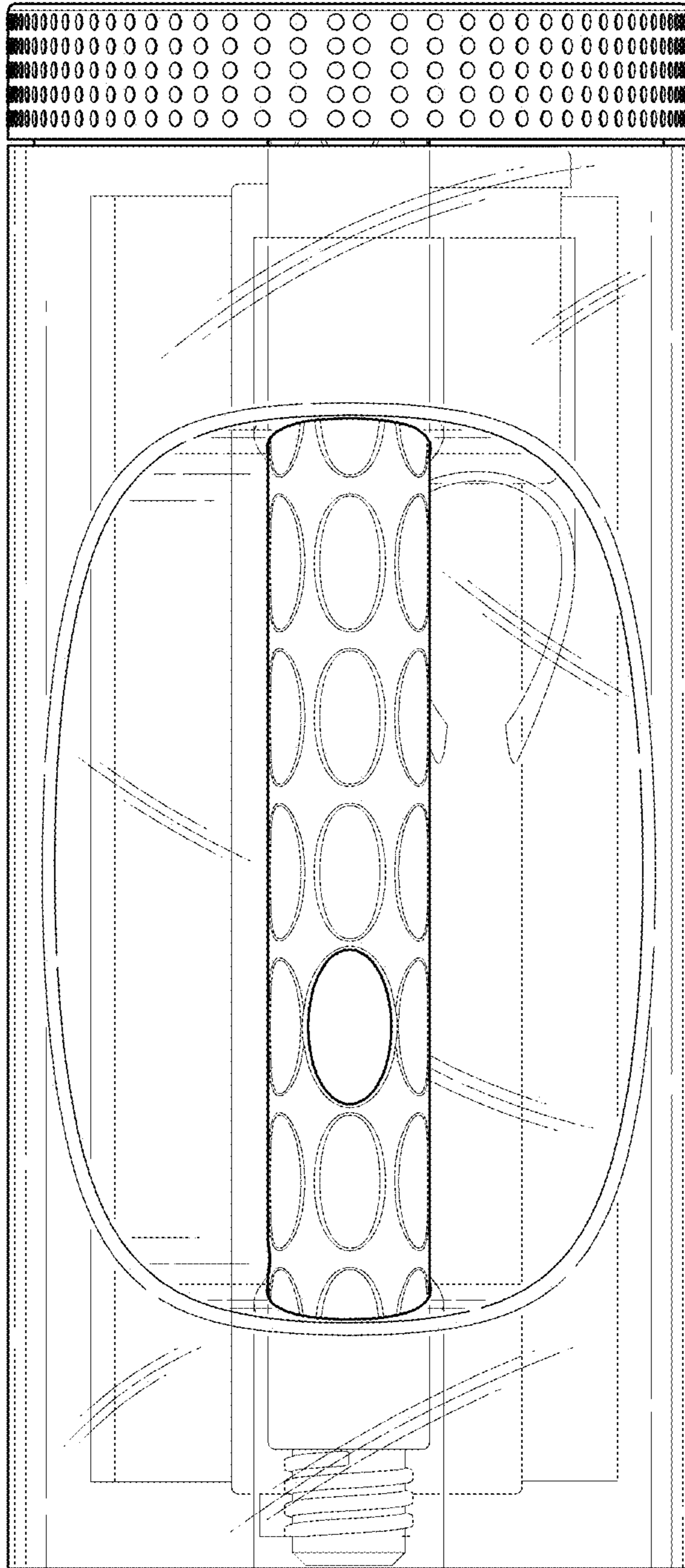

FIG. 3

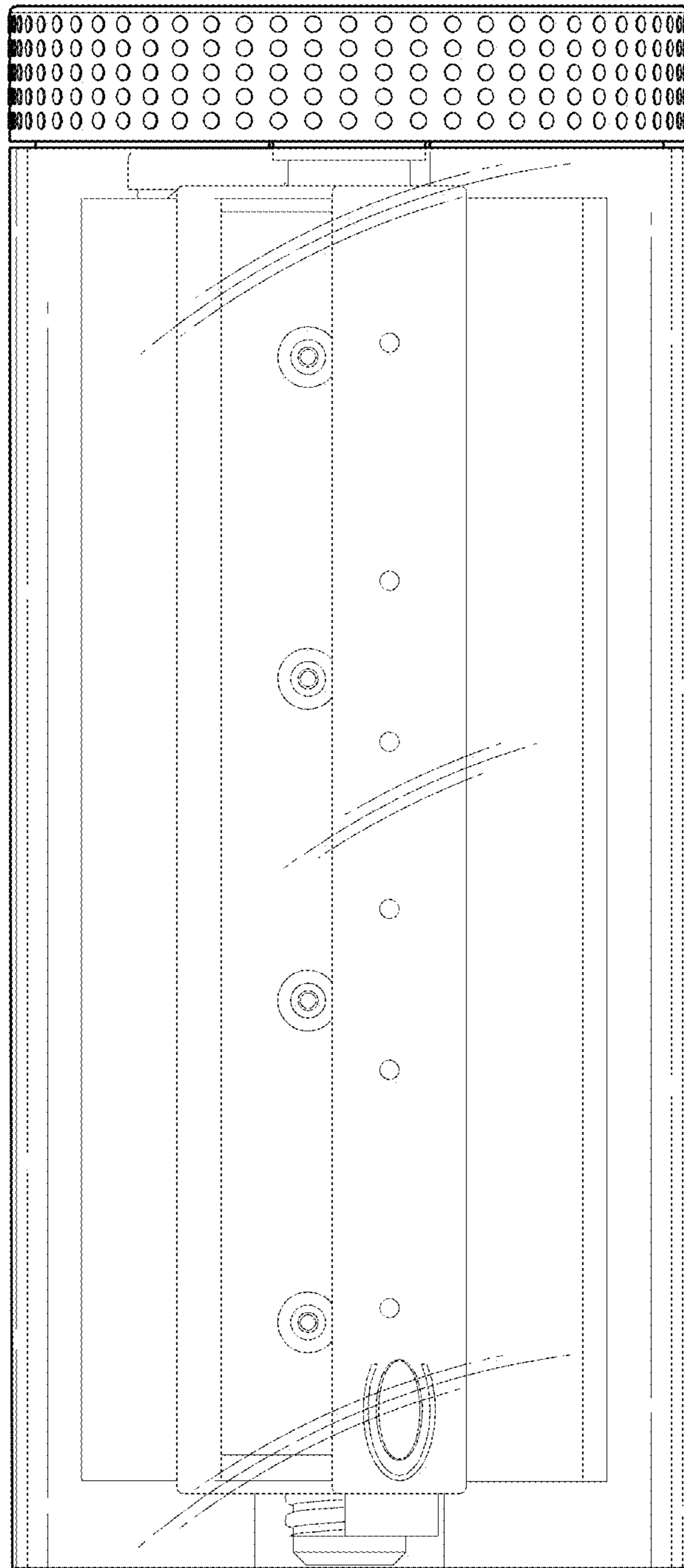

FIG. 4

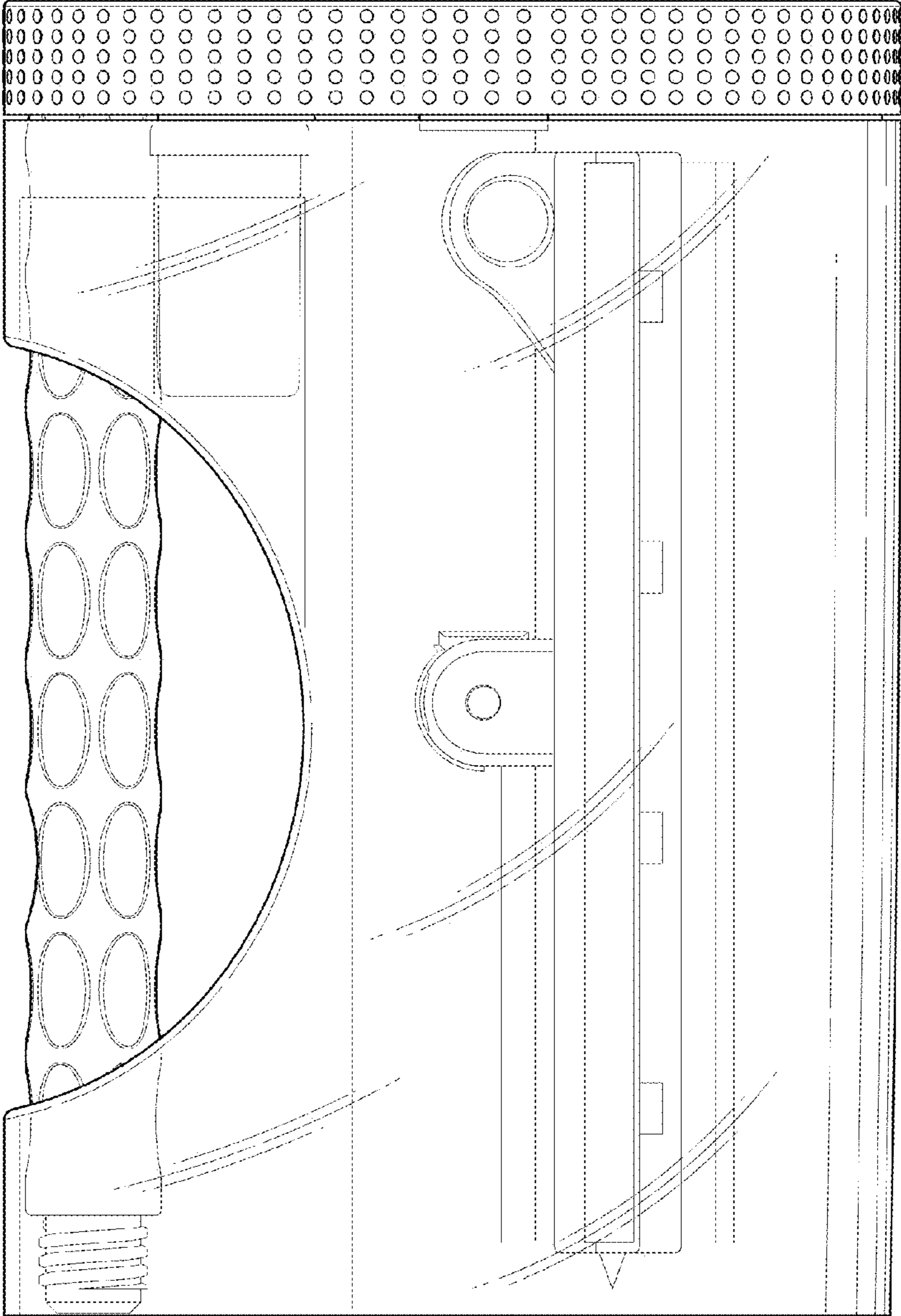

FIG. 5

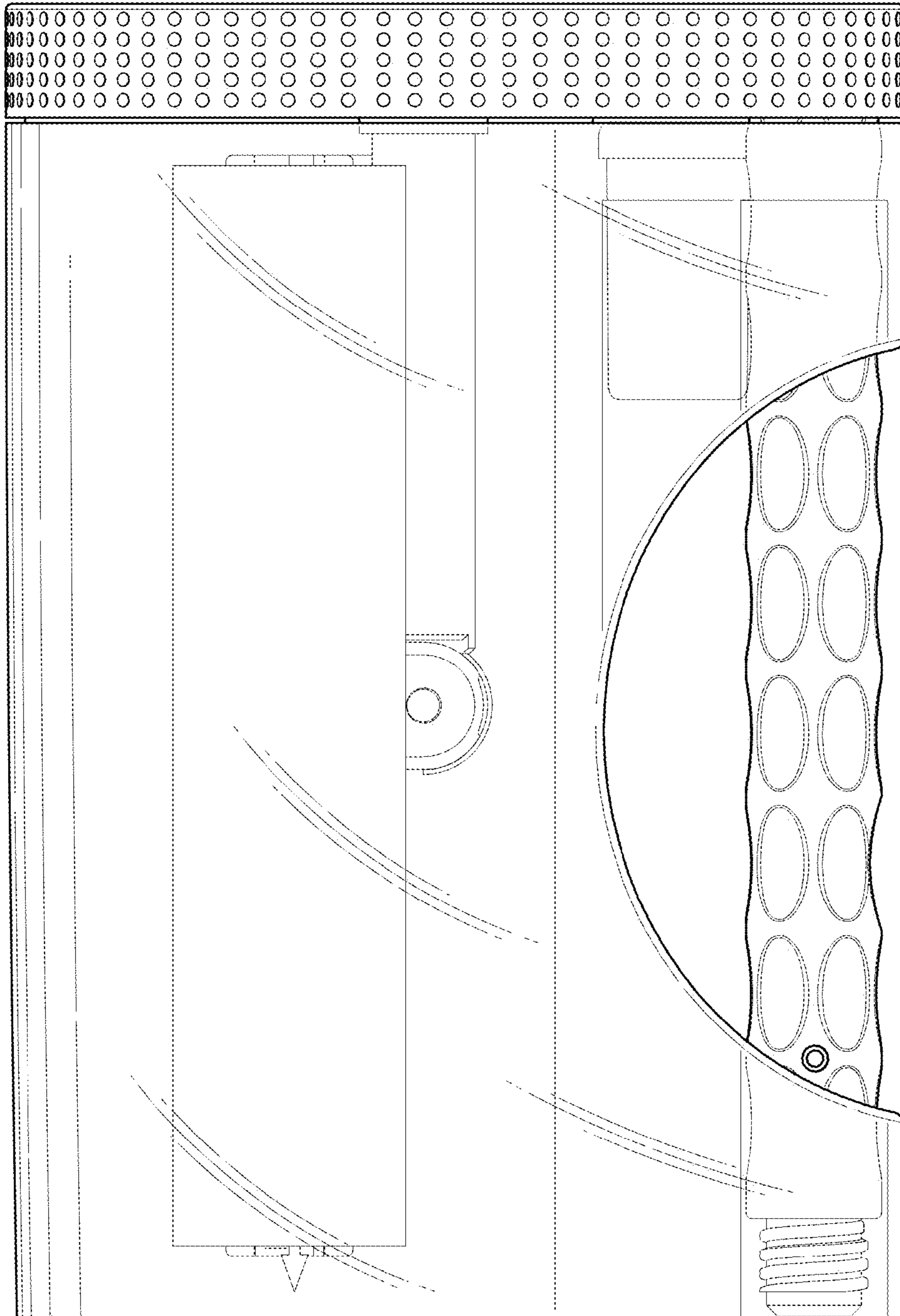

FIG. 6

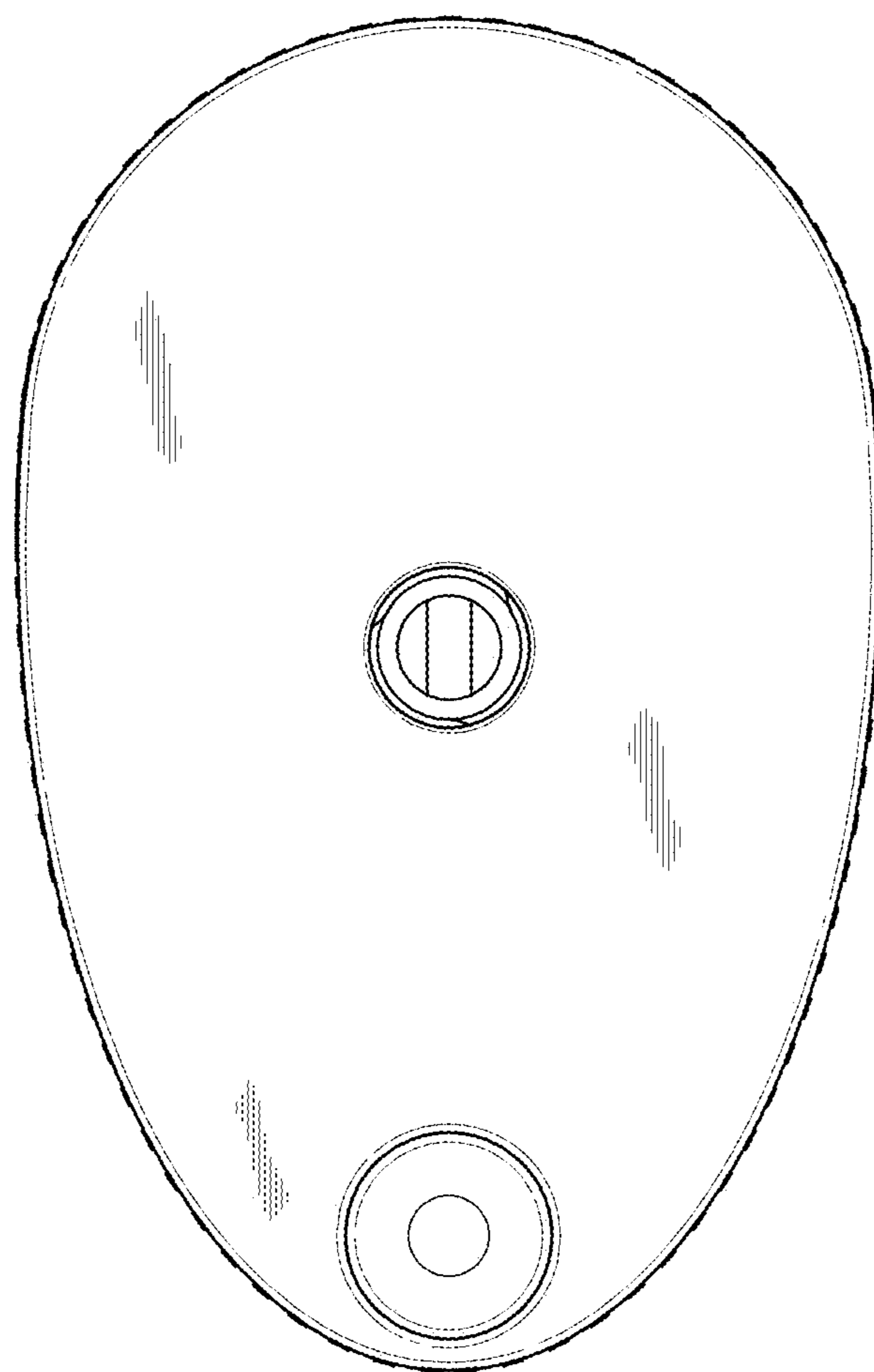

FIG. 7

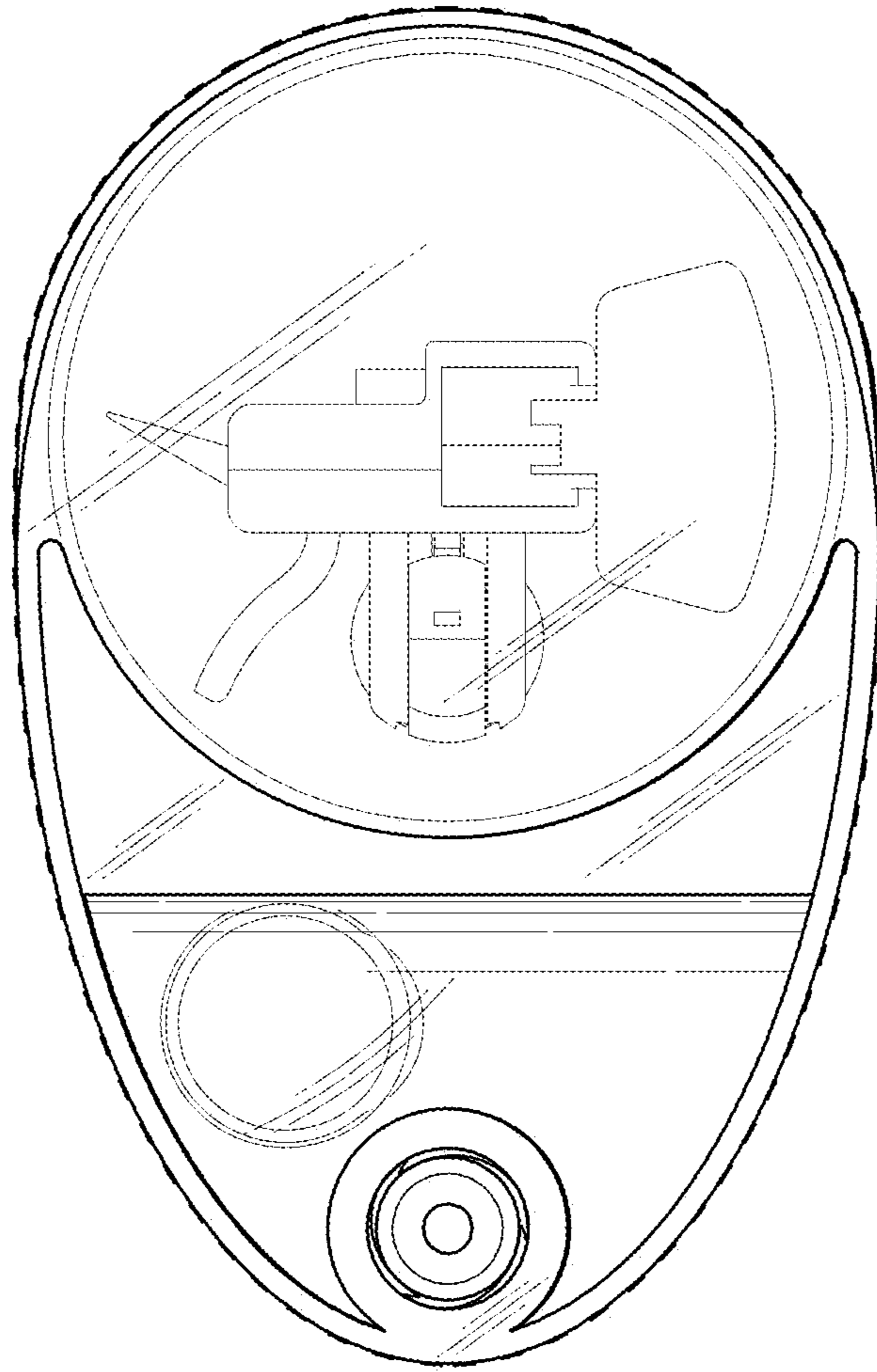

FIG. 8