



US00D685547S

(12) **United States Design Patent**
Vasilakes et al.

(10) **Patent No.:** **US D685,547 S**

(45) **Date of Patent:** **** Jul. 2, 2013**

(54) **CLEANING TOOL**

(75) Inventors: **Lloyd S. Vasilakes**, Stillwater, MN (US);
Qian Zheng Zhou, Shanghai (CN);
Giuseppe De Bellis, Milanese (IT);
Valentina Tronconi, Milan (IT); **Monica Jerez**, Woodbury, MN (US); **Adel M. Kassem Llano**, Milan (IT)

(73) Assignee: **3M Innovative Properties Company**,
St. Paul, MN (US)

(**) Term: **14 Years**

(21) Appl. No.: **29/425,721**

(22) Filed: **Jun. 26, 2012**

(51) **LOC (9) Cl.** **04-01**

(52) **U.S. Cl.**

USPC **D32/40**; D32/41

(58) **Field of Classification Search**

USPC D32/40-45, 50, 51; 15/245, 245.1,
15/244.1-244.4, 208, 209.1

See application file for complete search history.

(56) **References Cited**

U.S. PATENT DOCUMENTS

776,751	A *	12/1904	Morgan	15/147.1
948,641	A *	2/1910	Bailey	15/245
2,179,223	A *	11/1939	Siemund	15/245
D473,028	S *	4/2003	Hay et al.	D32/41
D512,193	S *	11/2005	Hay	D32/41
D517,758	S *	3/2006	Hay et al.	D32/41
7,748,074	B2 *	7/2010	Guizzi	15/245
D627,532	S *	11/2010	Yang et al.	D32/41
D652,595	S *	1/2012	Pottes	D32/41

* cited by examiner

Primary Examiner — Robin V Webster

(74) *Attorney, Agent, or Firm* — Irina Hass

(57) **CLAIM**

The ornamental design for a cleaning tool, as shown and described.

DESCRIPTION

FIG. 1 is a perspective view of a first embodiment of a cleaning tool showing the new design;
 FIG. 2 is a right side view thereof, the left side view being a mirror image thereof;
 FIG. 3 is a front view thereof;
 FIG. 4 is a bottom view thereof;
 FIG. 5 is a rear view thereof;
 FIG. 6 is a top view thereof;
 FIG. 7 is a perspective view thereof showing the cleaning tool with a long handle;
 FIG. 8 is a perspective view of a second embodiment of a cleaning tool showing the new design;
 FIG. 9 is a right side view thereof, the left side view being a mirror image thereof;
 FIG. 10 is a front view thereof;
 FIG. 11 is a bottom view thereof;
 FIG. 12 is a rear view thereof;
 FIG. 13 is a top view thereof; and,
 FIG. 14 is a perspective view thereof showing the cleaning tool with a long handle.

The broken lines in the drawings are shown for illustrative purposes only and form no part of the claimed design. In addition, the surface shading illustrated in the drawings is provided merely to highlight the contour of design; it is not intended to be illustrative of texture or gloss.

1 Claim, 8 Drawing Sheets

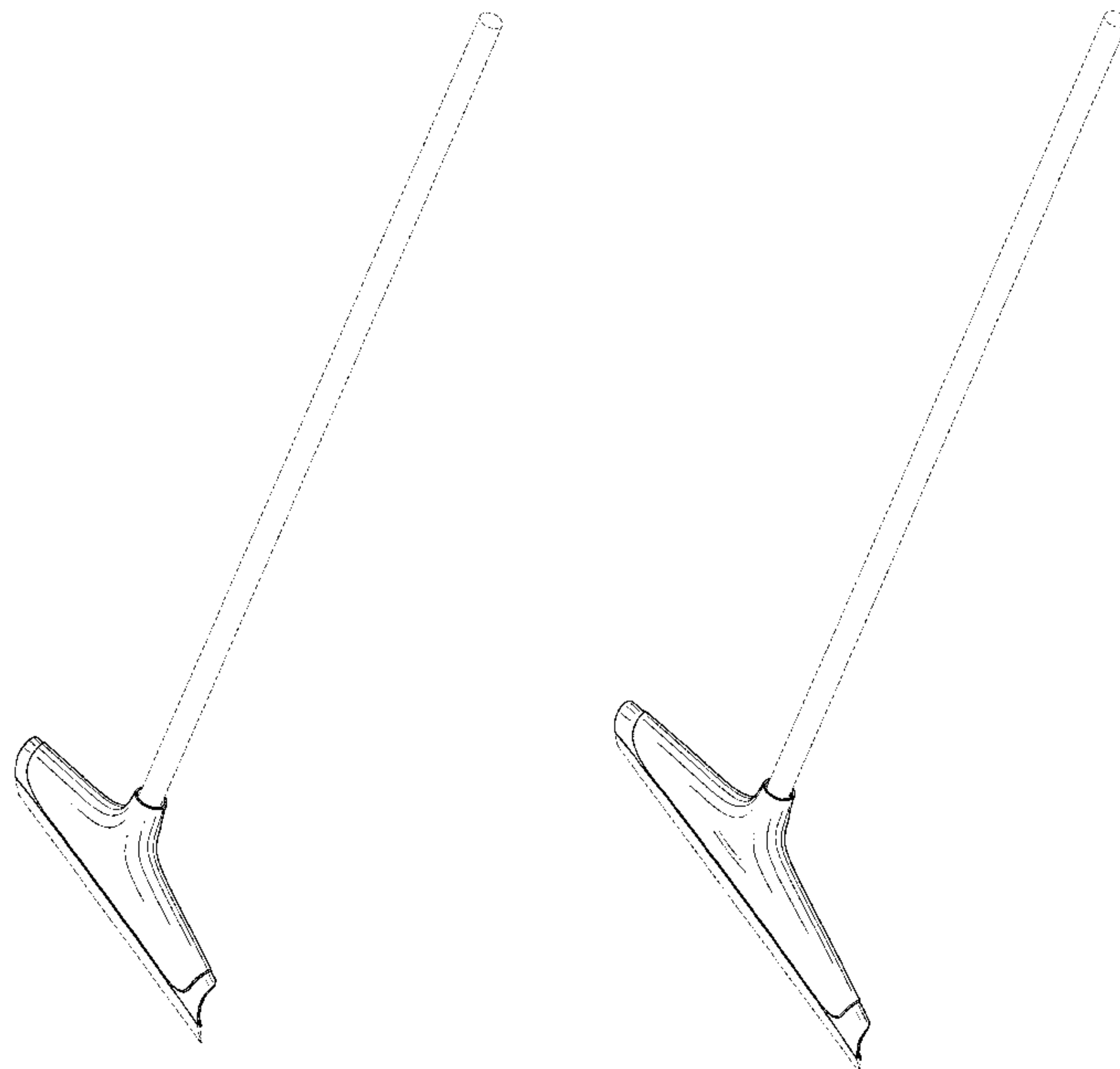

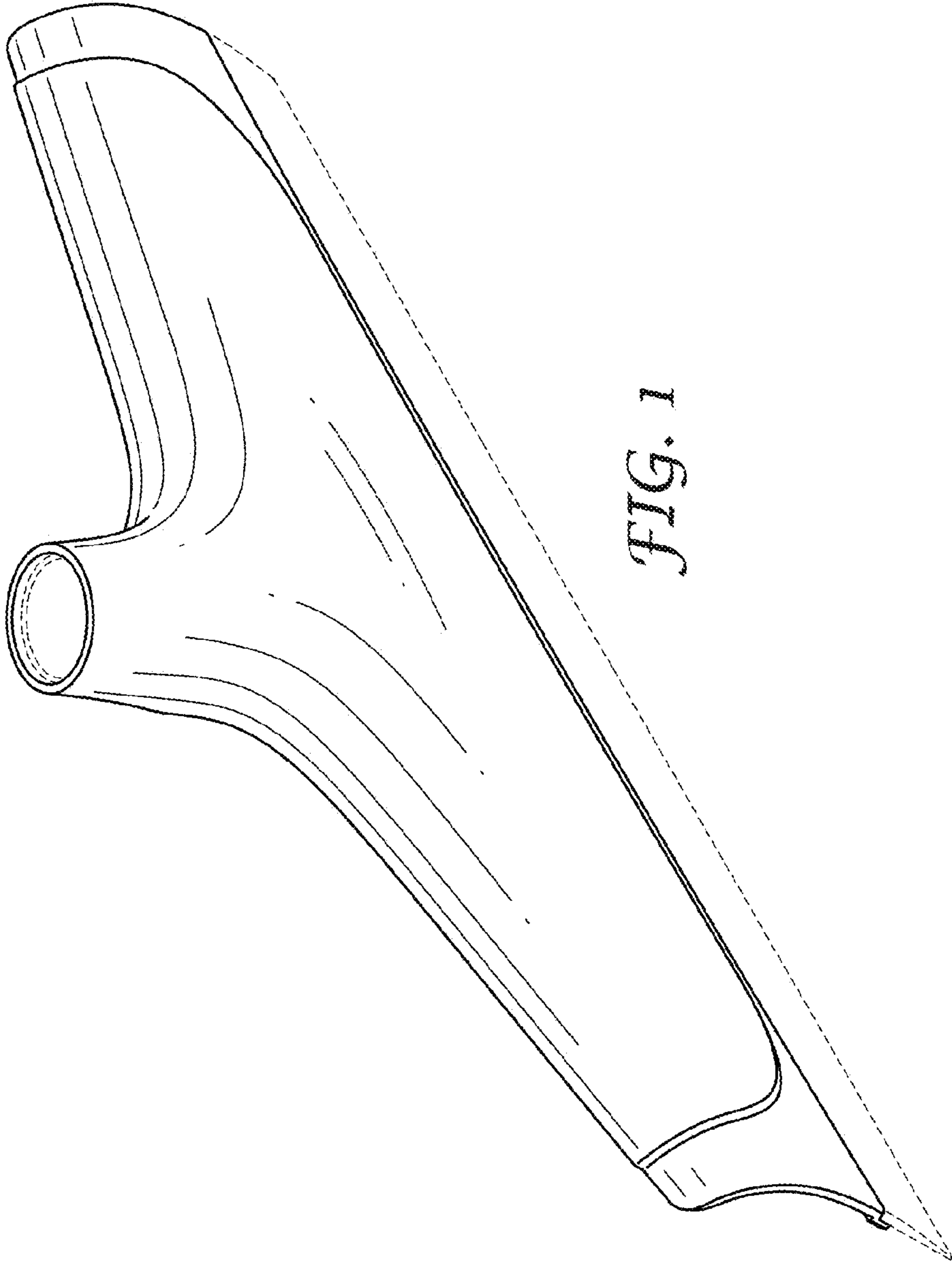

FIG. 1



FIG. 2

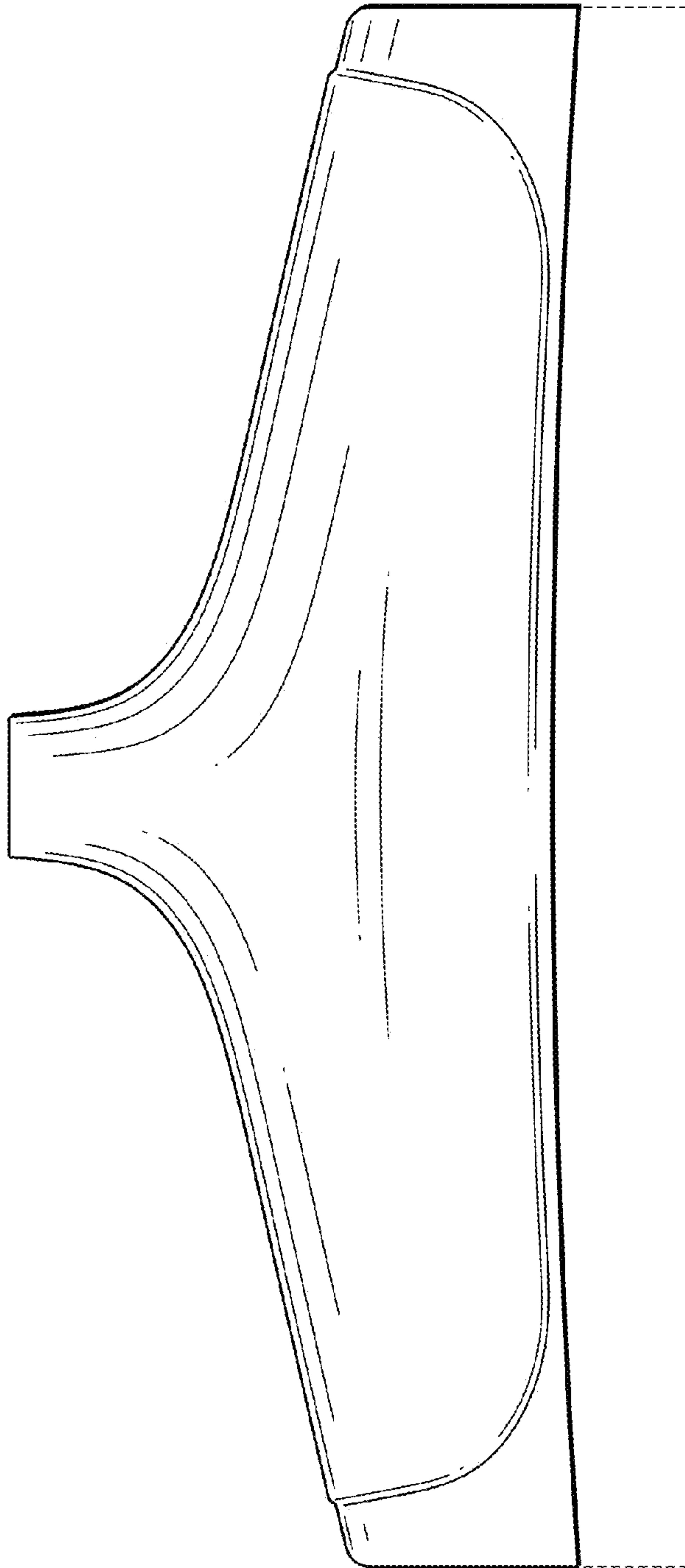

FIG. 3

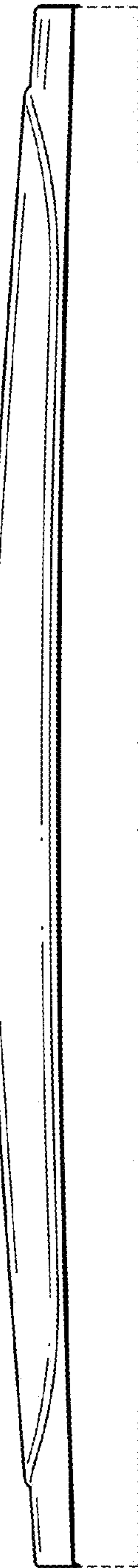

FIG. 4

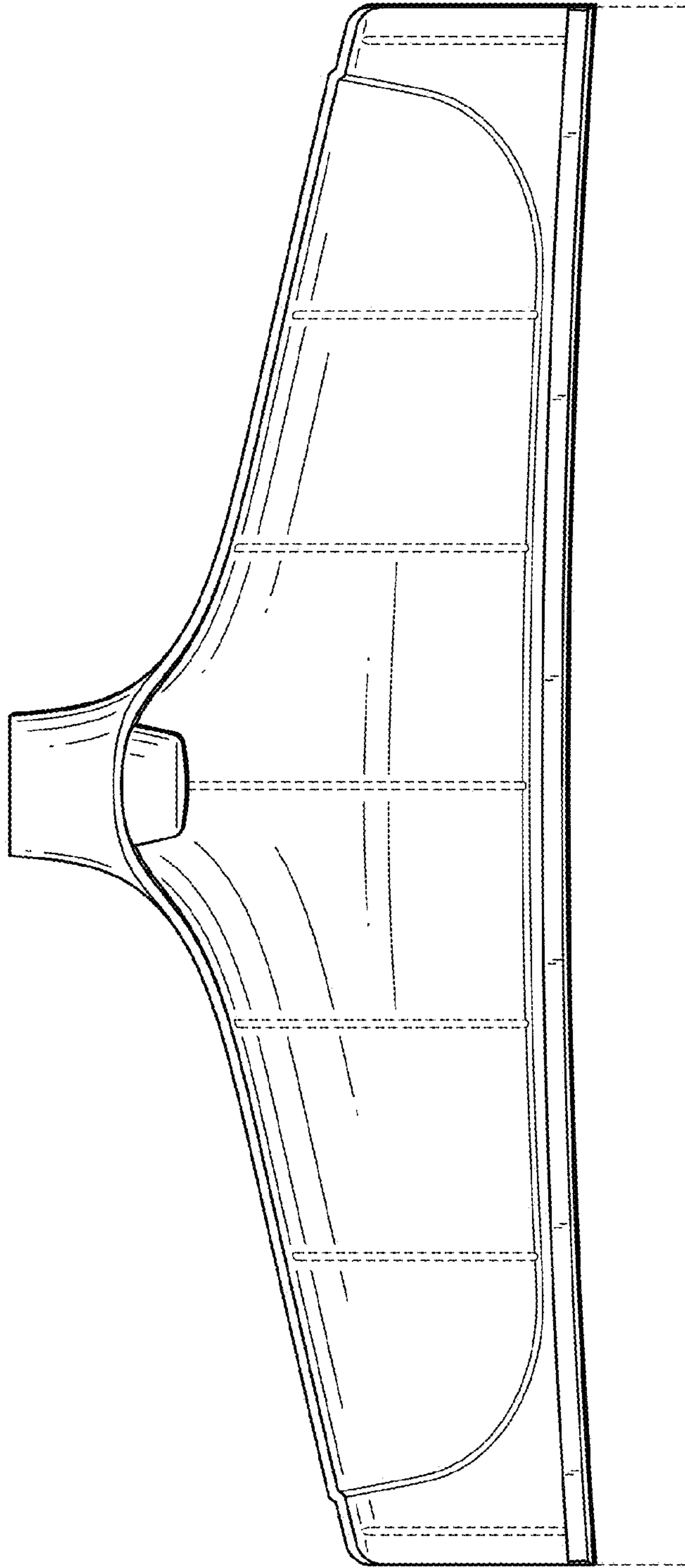

FIG. 5

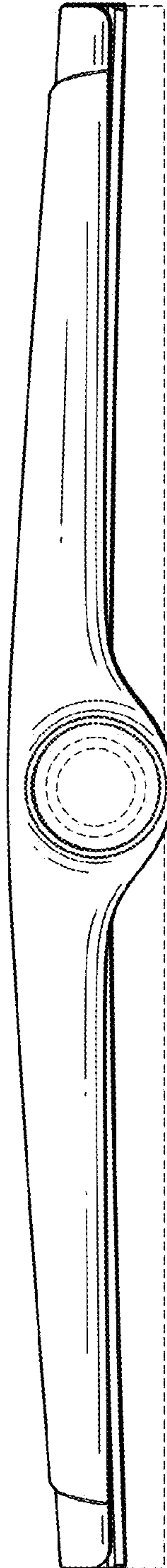

FIG. 6

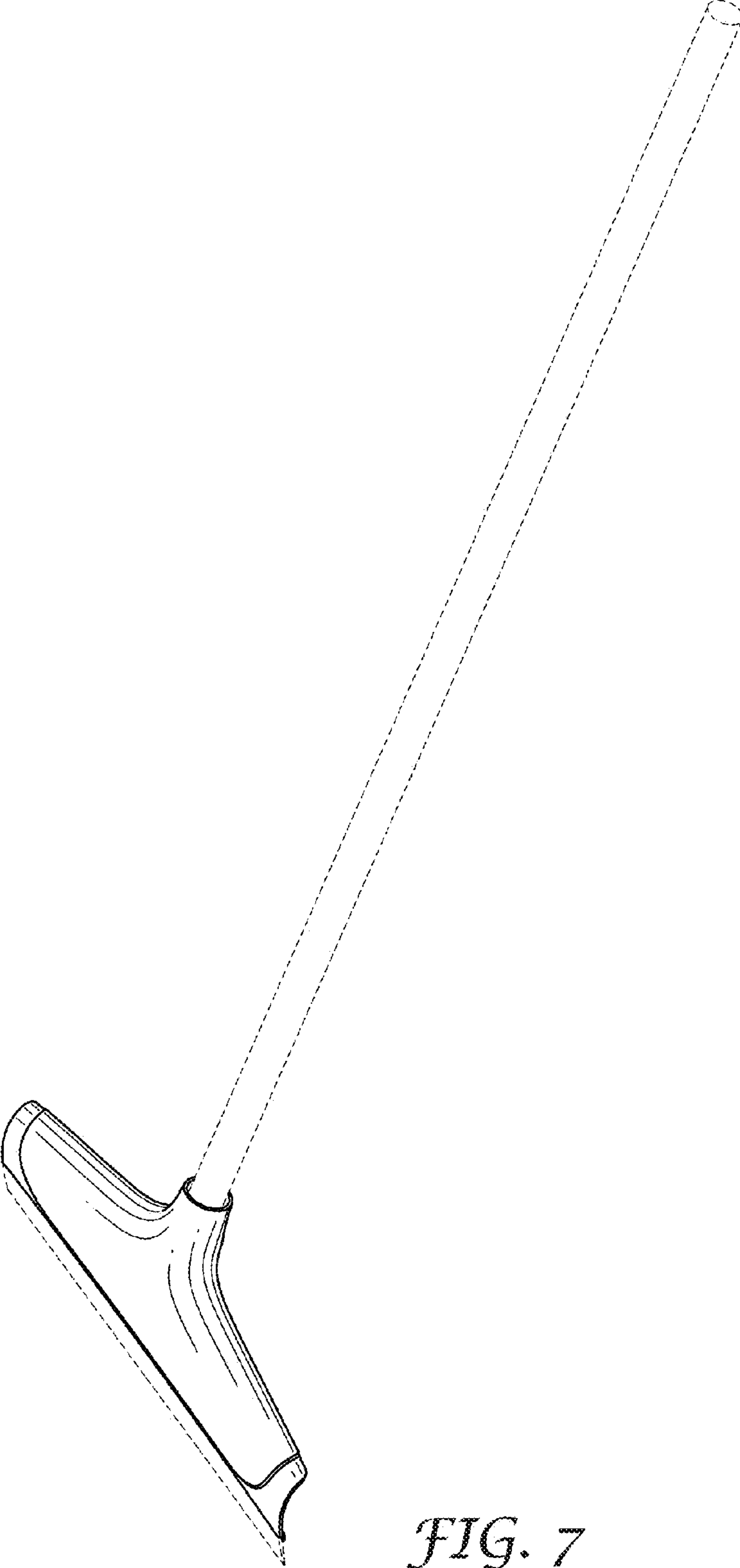

FIG. 7

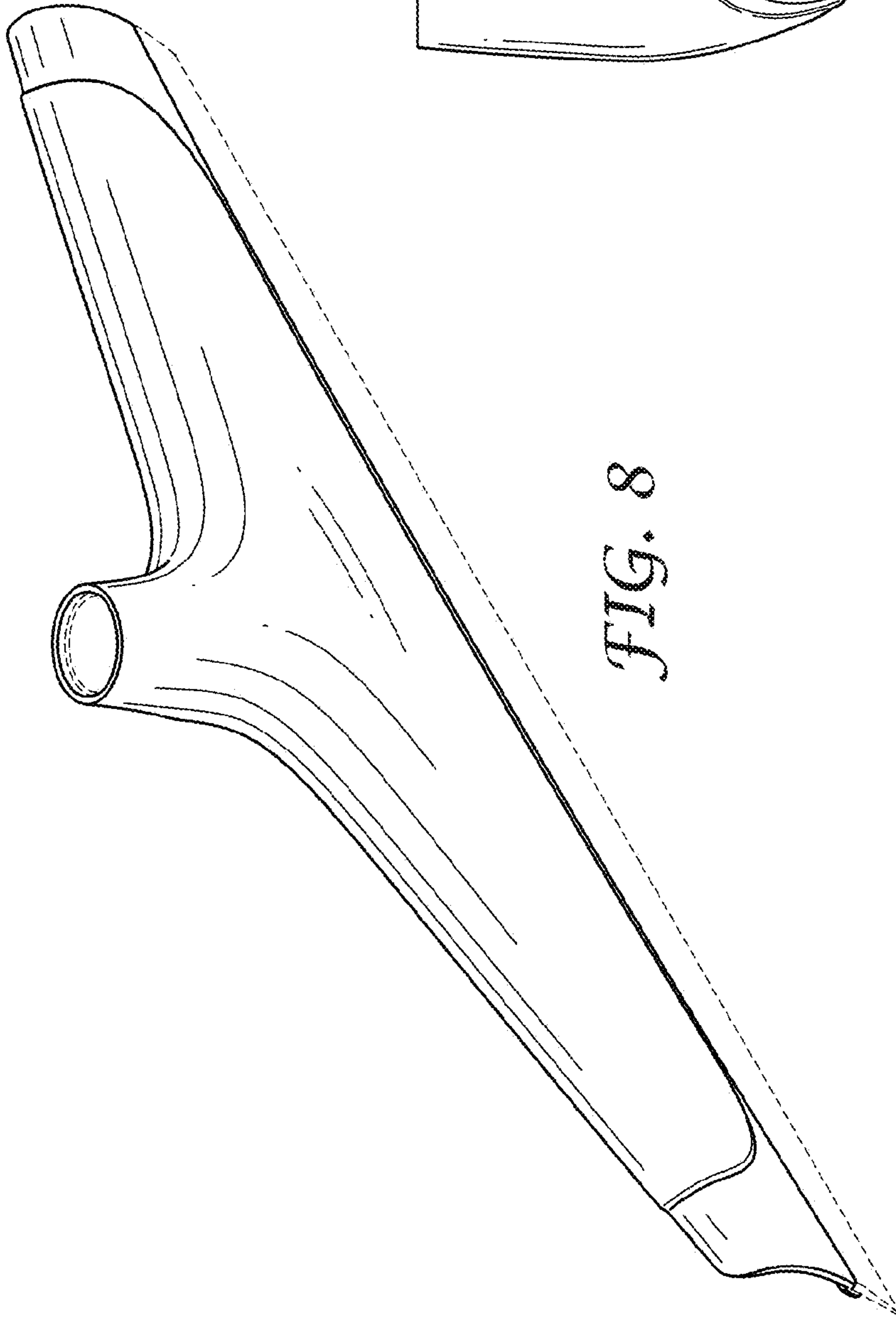

FIG. 8

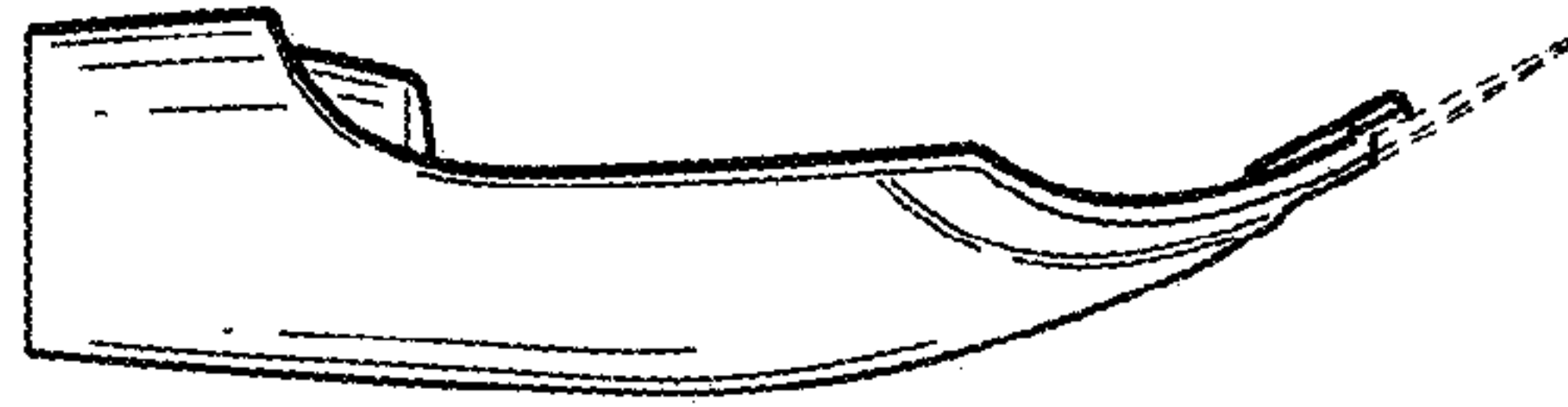

FIG. 9

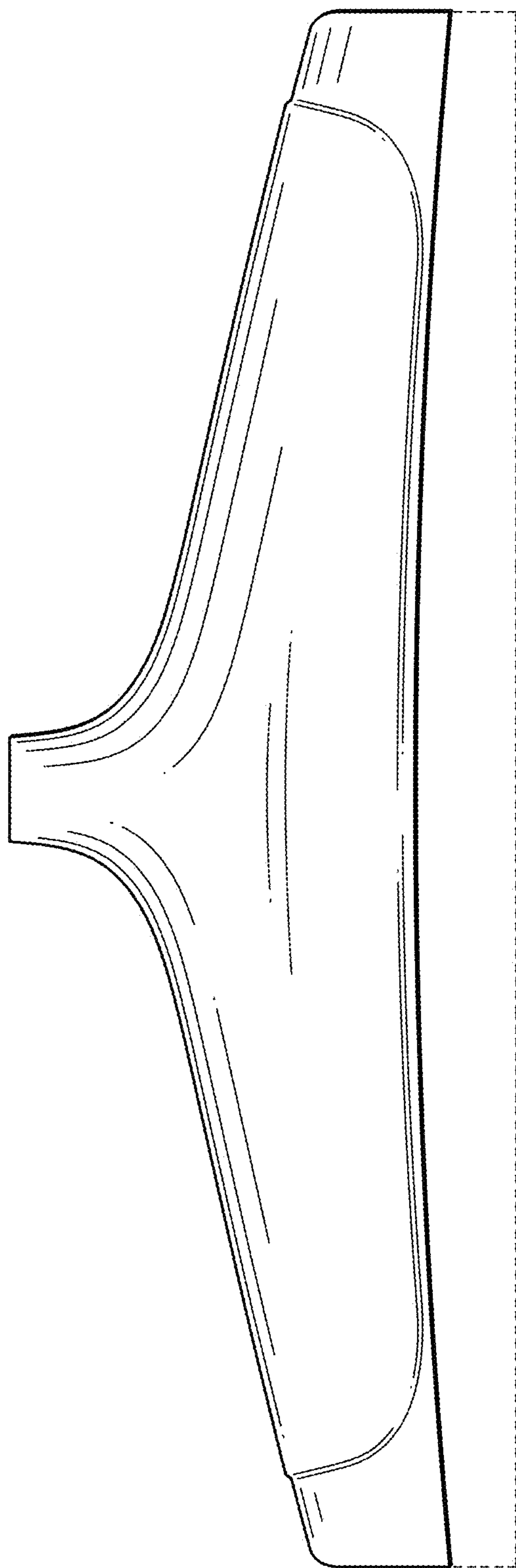

FIG. 10

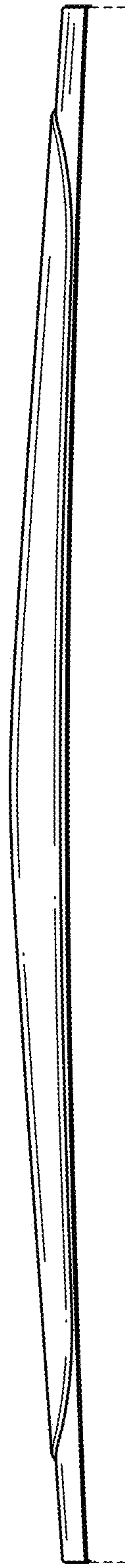

FIG. 11

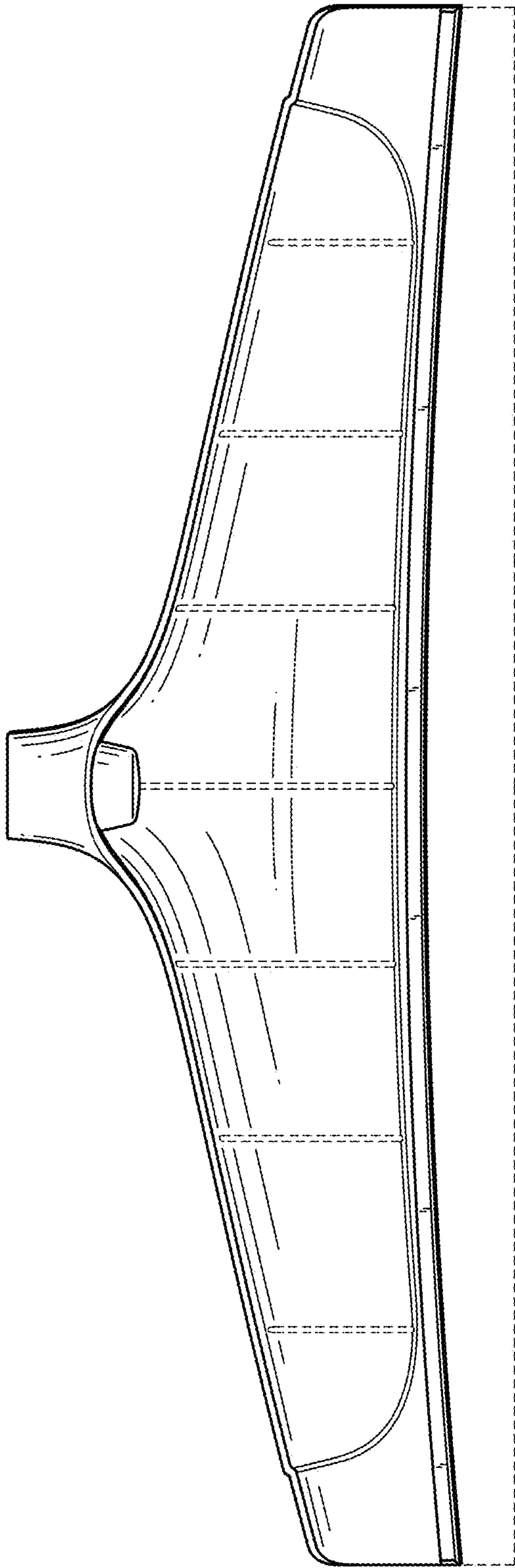

FIG. 12

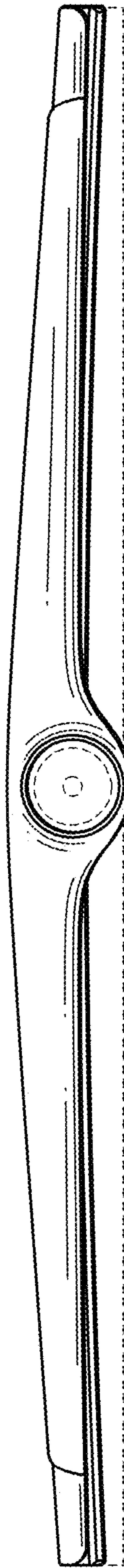

FIG. 13

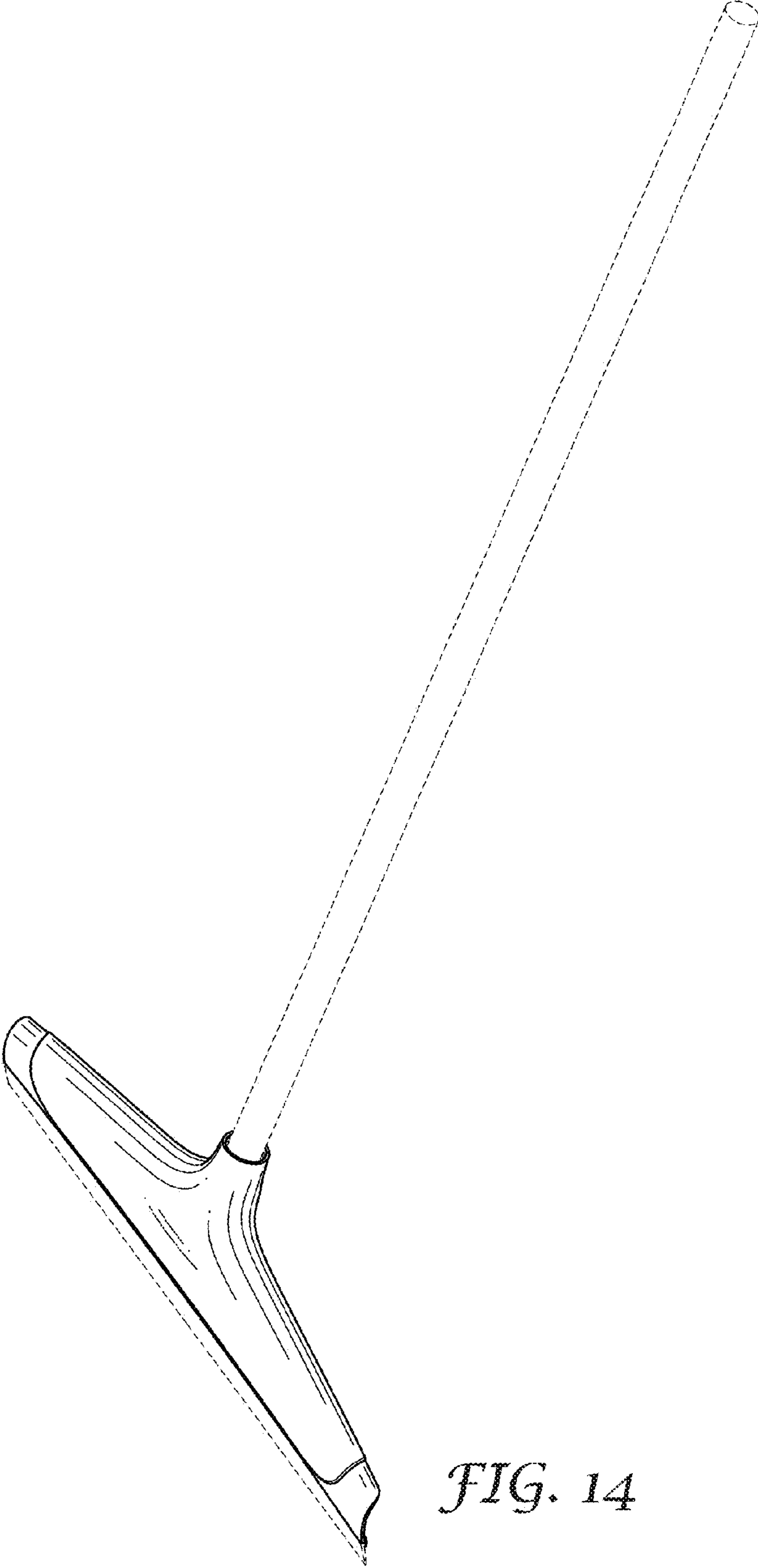

FIG. 14