



US00D685337S

(12) **United States Design Patent**
Lee

(10) **Patent No.:** **US D685,337 S**
(45) **Date of Patent:** **** Jul. 2, 2013**

(54) **TV RECEIVER**

(75) Inventor: **Sang-Young Lee**, Kyunggi-do (KR)

(73) Assignee: **Samsung Electronics Co., Ltd.**,
Suwon-si, Gyeonggi-do (KR)

(**) Term: **14 Years**

(21) Appl. No.: **29/426,428**

(22) Filed: **Jul. 5, 2012**

(30) **Foreign Application Priority Data**

Jan. 19, 2012 (KR) 30-2012-0002820

(51) **LOC (9) Cl.** **14-03**

(52) **U.S. Cl.**
USPC **D14/126**

(58) **Field of Classification Search**
USPC D14/125-134, 239, 371, 136, 374-377,
D14/440, 450, 448, 336, 342, 159; 312/7.2;
248/917-924, 465; 345/104, 133, 156, 168,
345/87, 173; 720/605, 669, 600, 655; 369/99,
369/197; 455/344, 347; D21/329, 515, 577,
D21/622, 333, 433, 448, 452, 450, 331; D6/477,
D6/479, 300; 273/148 B; 446/484, 175, 356;
D10/15, 26

See application file for complete search history.

(56) **References Cited**

U.S. PATENT DOCUMENTS

D570,841 S	6/2008	Kim et al.
D572,682 S	7/2008	Won et al.
D573,118 S	7/2008	Yang et al.
D584,258 S	1/2009	Yang et al.
D601,104 S	9/2009	Kim
D603,816 S	11/2009	Kim et al.
D603,817 S	11/2009	Kim et al.
D605,148 S	12/2009	Boo et al.
D605,149 S	12/2009	Kim et al.

D608,314 S	1/2010	Boo et al.	
D614,596 S	4/2010	Won et al.	
D615,511 S *	5/2010	Shin et al.	D14/126
D625,278 S	10/2010	Kim et al.	
D655,264 S	3/2012	Lee et al.	
D655,265 S	3/2012	Ann et al.	
D656,117 S	3/2012	Won et al.	
D657,326 S *	4/2012	Kim et al.	D14/126
D658,613 S	5/2012	Lee et al.	
D669,872 S *	10/2012	Yagi	D14/126

OTHER PUBLICATIONS

U.S. Appl. No. 29/426,390, Applicant: Yu-Li Sung, filed Jul. 5, 2012 entitled TV Receiver.

U.S. Appl. No. 29/373,618, Applicant: Ji-Gwang Kim, et al., filed May 3, 2011 entitled Television Receiver.

U.S. Appl. No. 29/422,973, Applicant: Jae-Hyung Kim, et al., filed May 25, 2012 entitled TV Receiver.

U.S. Appl. No. 29/422,068, Applicant: Dong-Hee Won, et al., filed May 16, 2012 entitled TV Receiver.

* cited by examiner

Primary Examiner — Raphael Barkai

(74) *Attorney, Agent, or Firm* — Flynn, Thiel, Boutell & Tanis, P.C.

(57) **CLAIM**

The ornamental design for a TV receiver, as shown and described.

DESCRIPTION

FIG. 1 is a top front perspective view of a TV receiver showing my new design;

FIG. 2 is a front elevational view thereof;

FIG. 3 is a rear elevational view thereof;

FIG. 4 is a left side elevational view thereof;

FIG. 5 is a right side elevational view thereof;

FIG. 6 is a top plan view thereof; and,

FIG. 7 is a bottom plan view thereof.

1 Claim, 4 Drawing Sheets

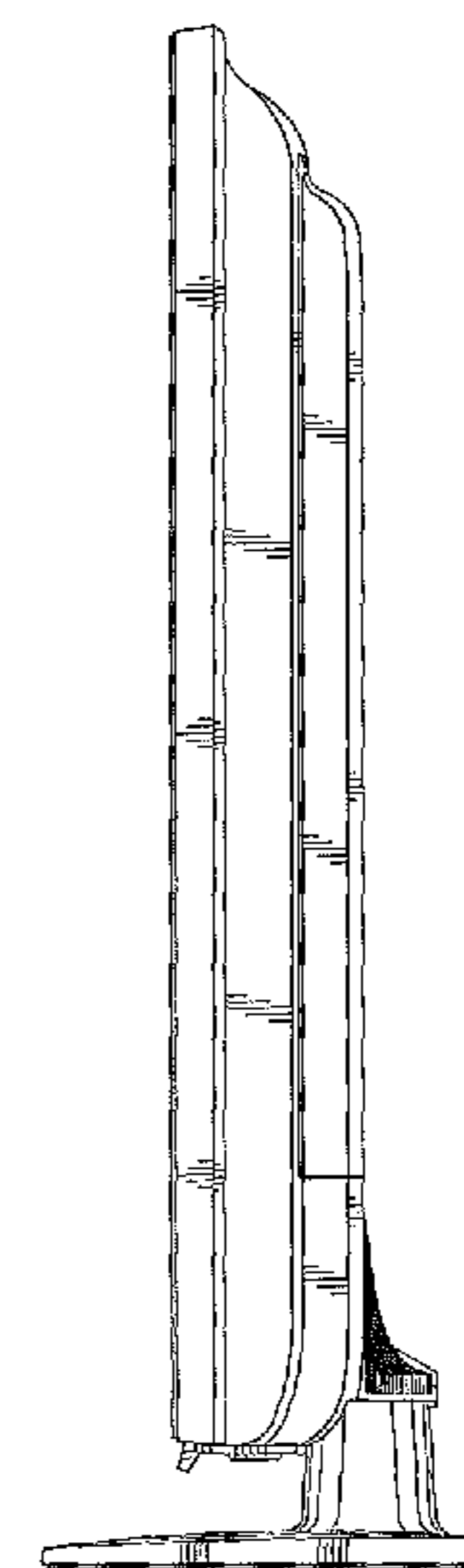
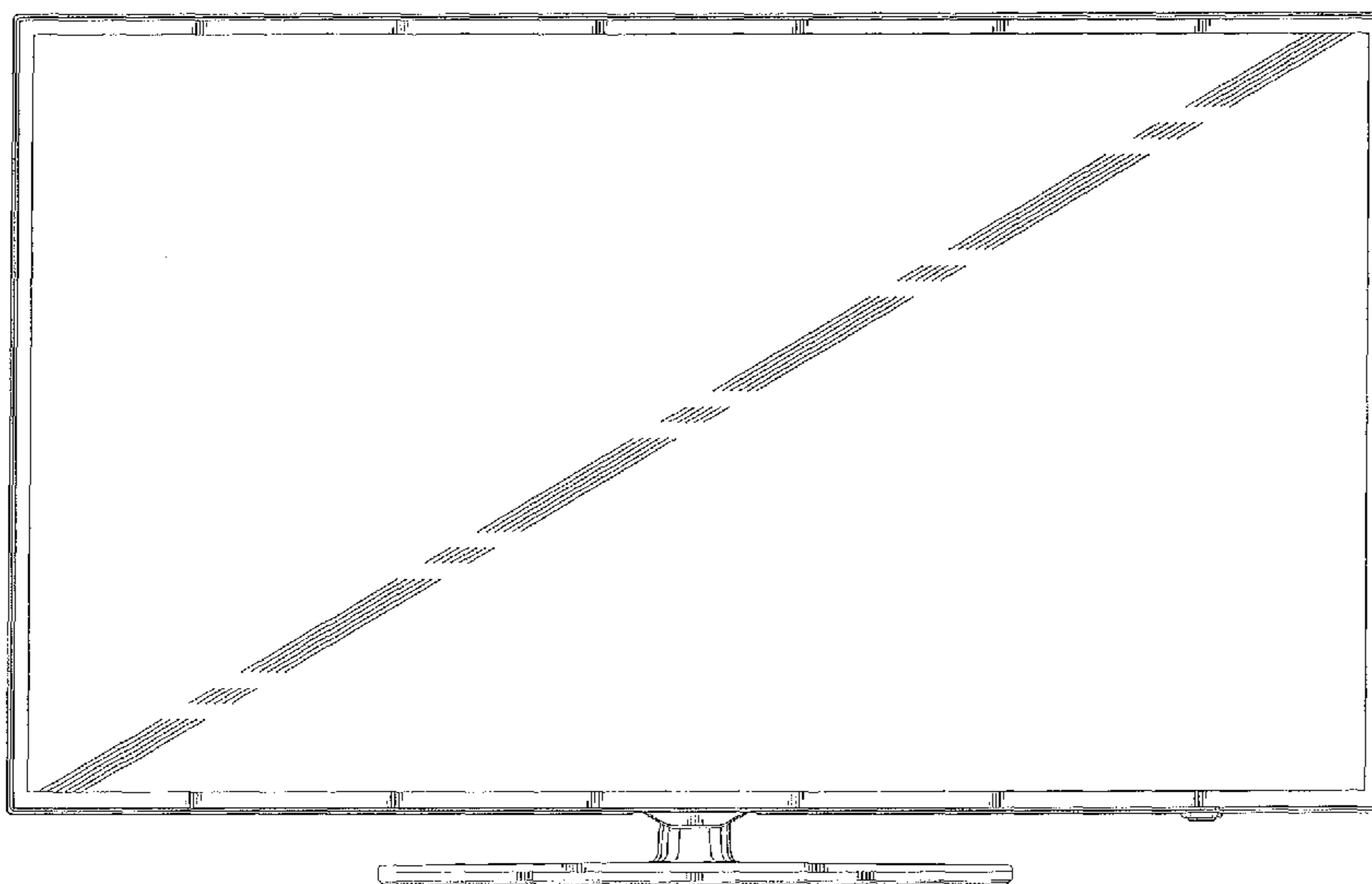

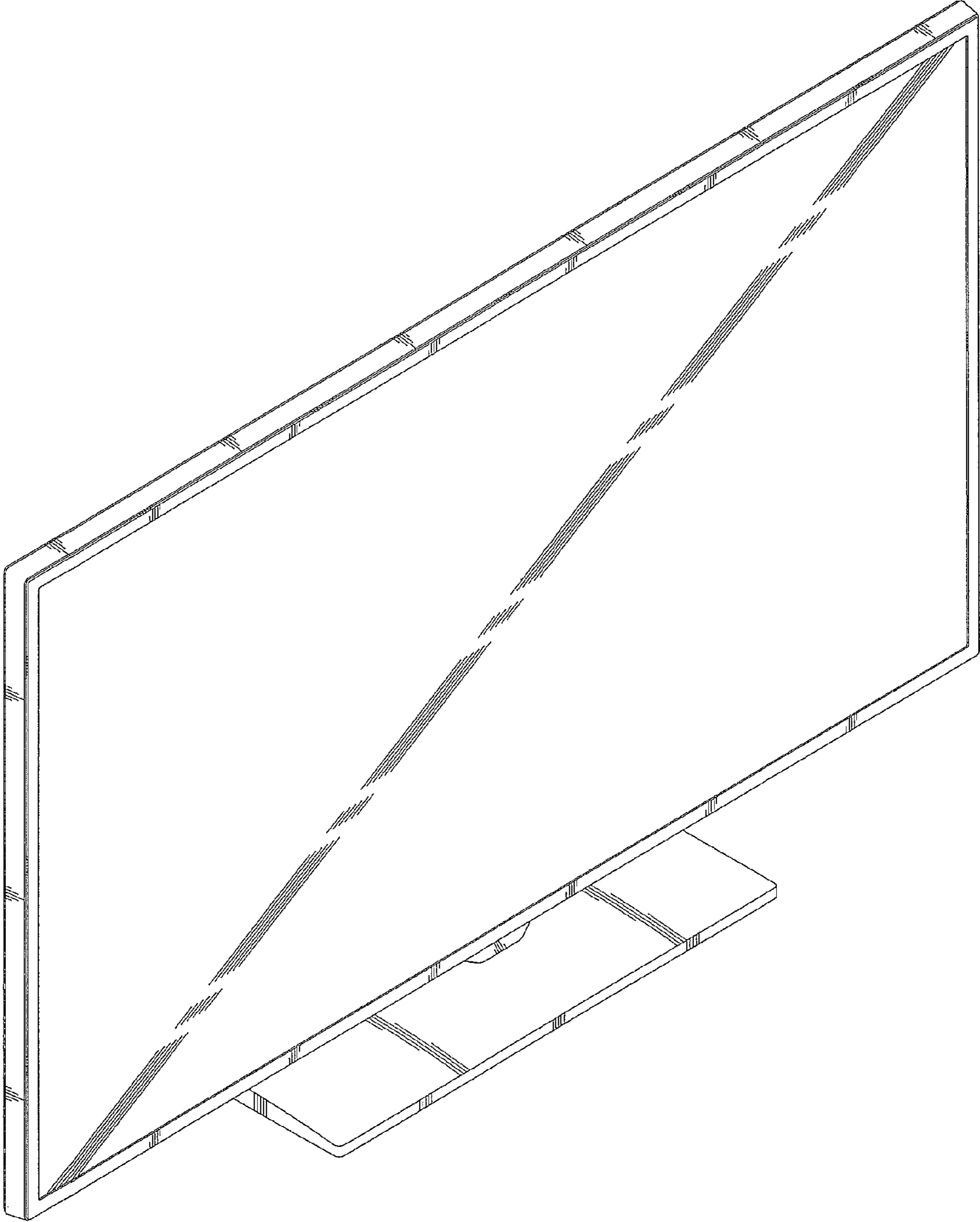

FIG.1

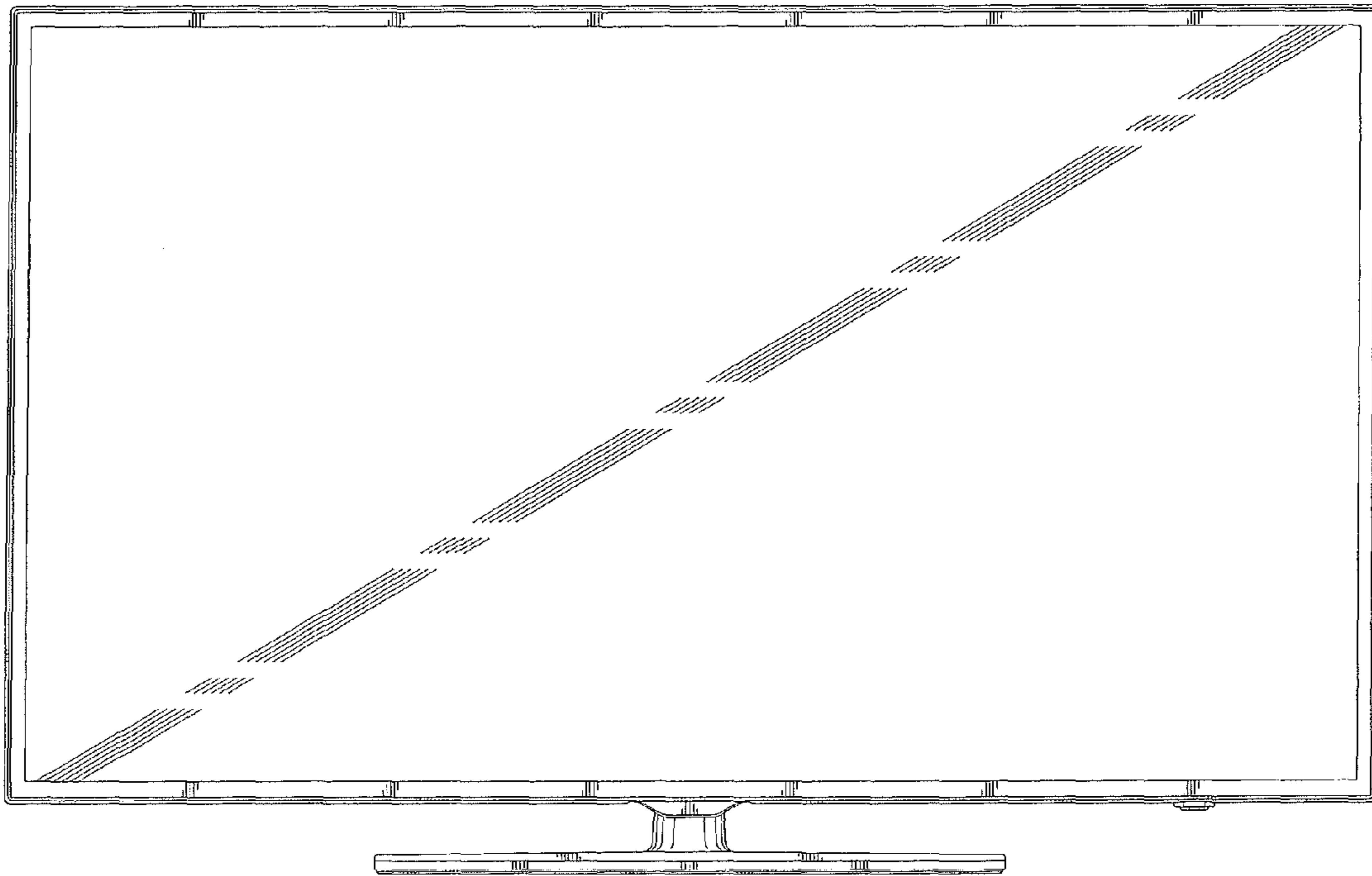

FIG. 2

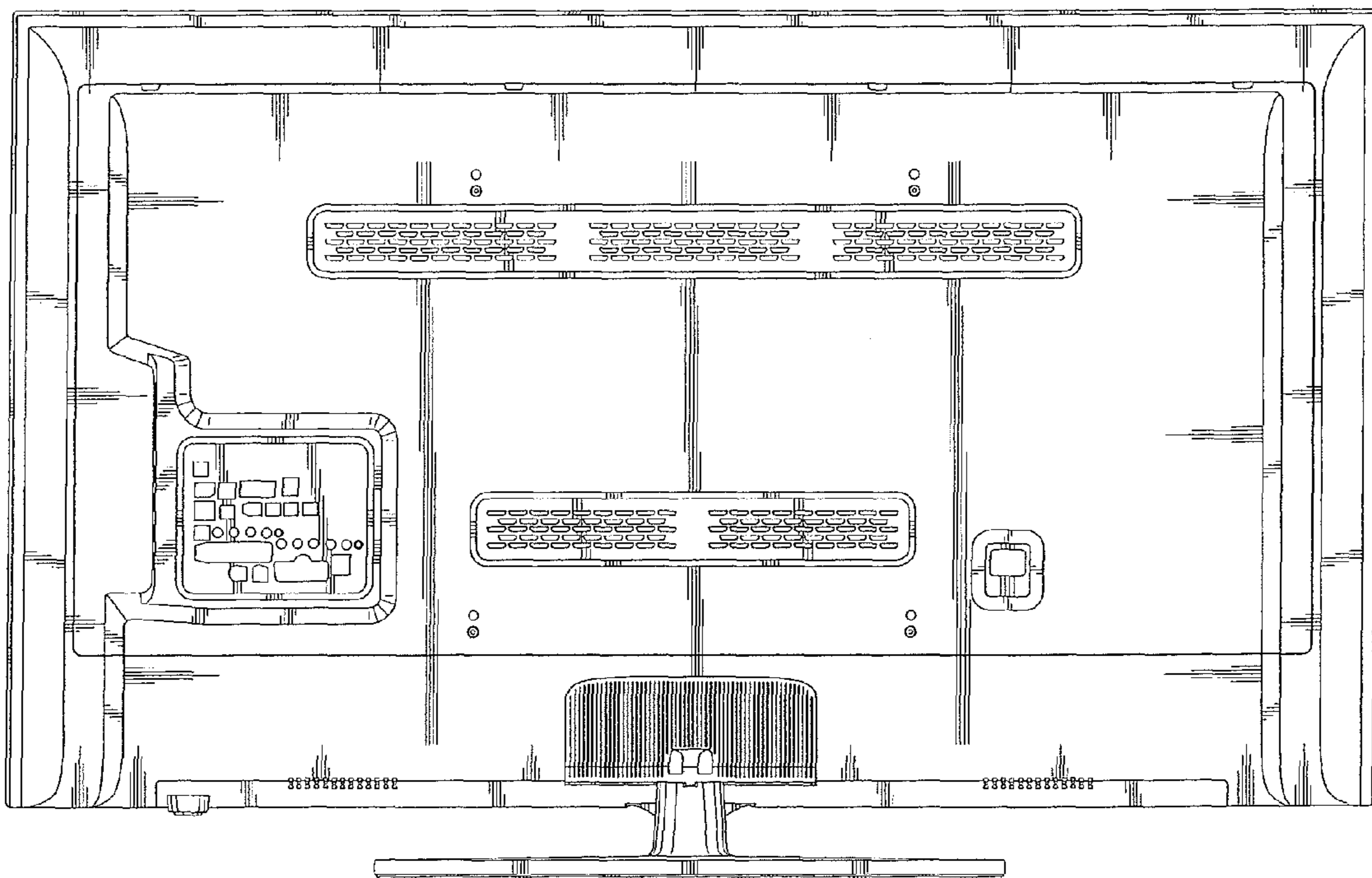

FIG. 3

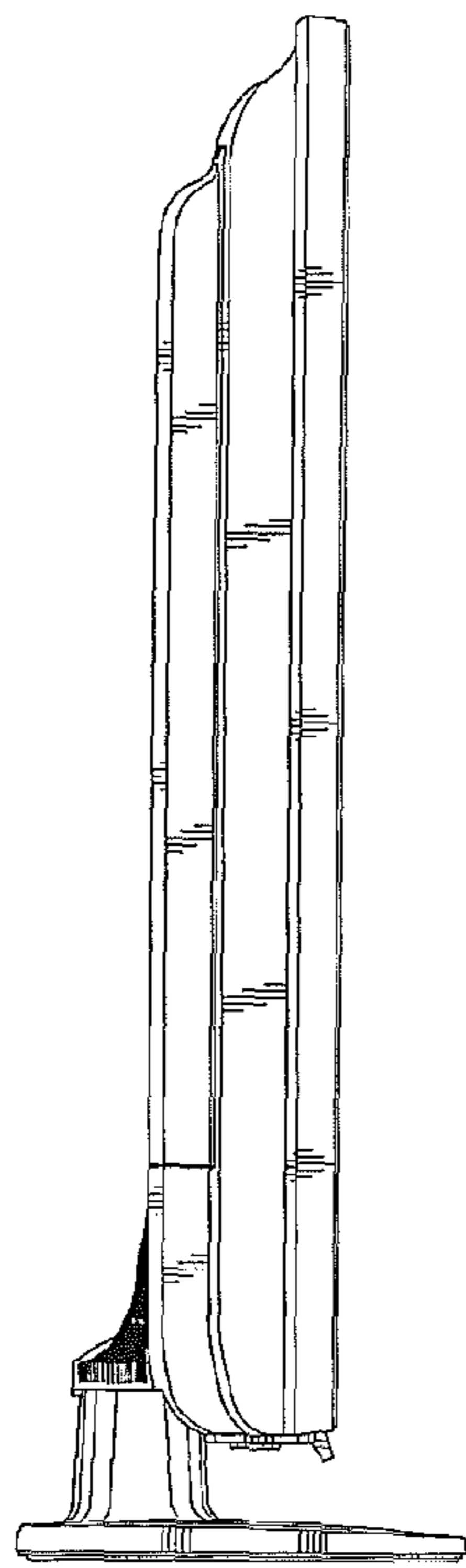

FIG. 4

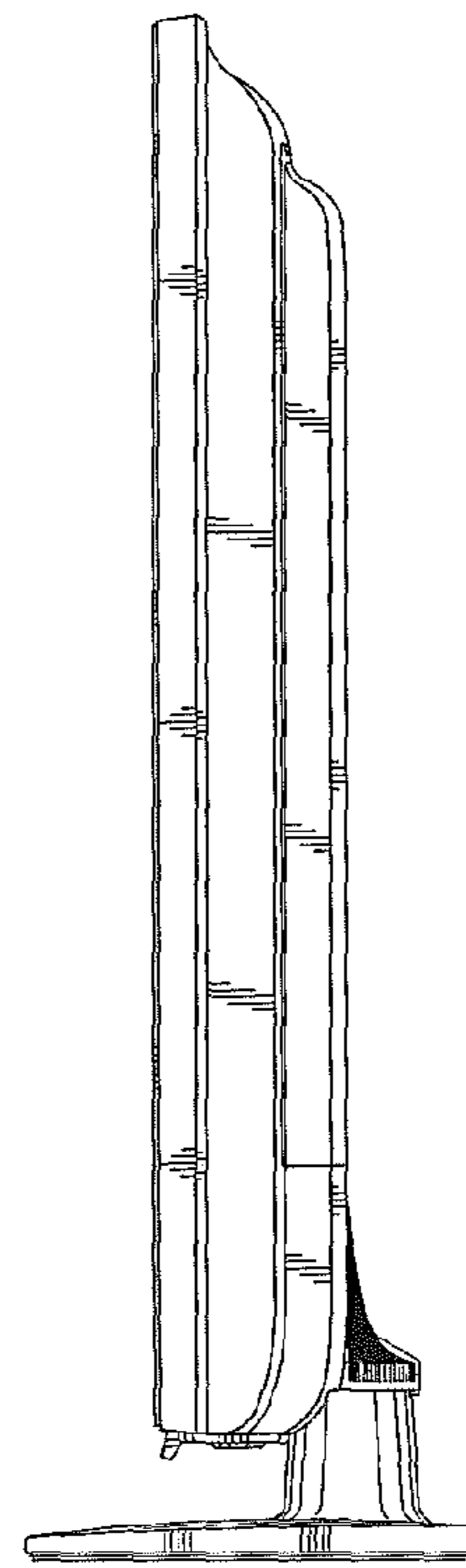

FIG. 5

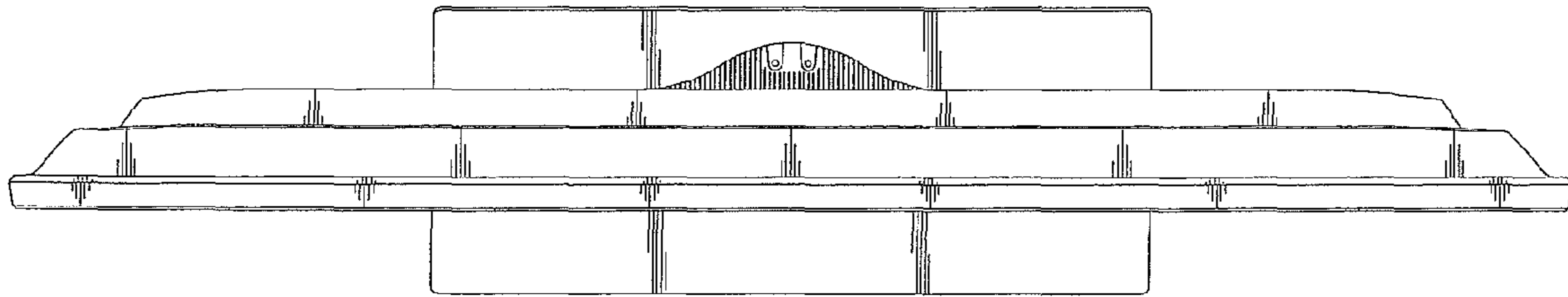

FIG.6

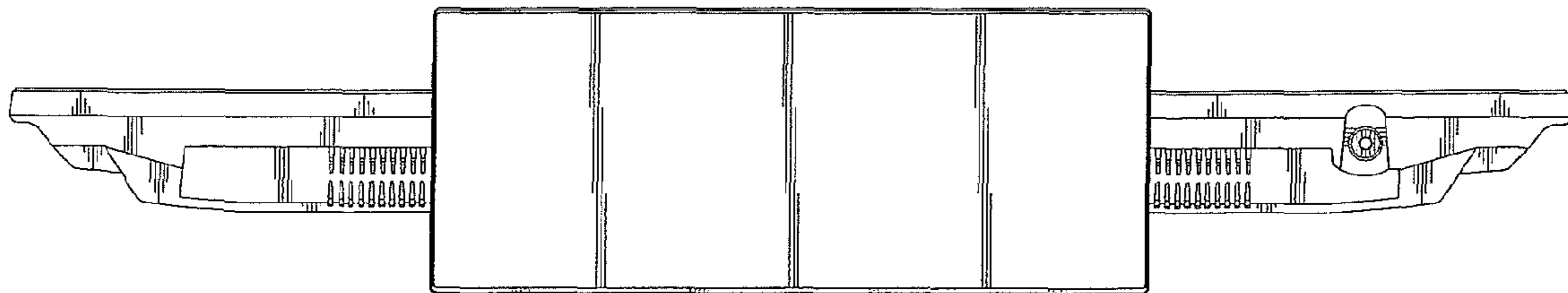

FIG.7