



US00D685228S

(12) **United States Design Patent**  
**Daugherty et al.**

(10) **Patent No.:** **US D685,228 S**  
(45) **Date of Patent:** **\*\* Jul. 2, 2013**

(54) **HELMET SHAPED COOLER**

(76) Inventors: **Brian Daugherty**, Baton Rouge, LA (US); **Don Paul Day**, Baton Rouge, LA (US); **Douglas Brian Clavier**, Midlothian, TX (US)

(\*\*) Term: **14 Years**

(21) Appl. No.: **29/391,470**

(22) Filed: **May 9, 2011**

(51) **LOC (9) Cl.** ..... **07-01**

(52) **U.S. Cl.**  
USPC ..... **D7/606**

(58) **Field of Classification Search**  
USPC ..... D7/603-608, 628; 62/457.1-457.9, 62/371, 372; 220/915.1, 915.2, 592.03, 592.09, 220/592.02, 592.16; 206/457; 280/655.1, 280/47.26, 43.1, 29, 43.24, 43.17, 47.17, 280/64, 242.1, 200

See application file for complete search history.

(56) **References Cited**

U.S. PATENT DOCUMENTS

D231,523	S *	4/1974	Baker	.....	D12/83
4,566,292	A *	1/1986	Parmet		
D289,598	S *	5/1987	Parmet	.....	D7/606
D349,630	S *	8/1994	Redmon	.....	D7/606
D352,211	S *	11/1994	Rucks	.....	D7/606
D409,050	S *	5/1999	Anderson et al.	.....	D7/606
D415,658	S *	10/1999	Frehse	.....	D7/605
D521,322	S *	5/2006	Loving	.....	D7/606
D613,128	S *	4/2010	Blakeman	.....	D7/606
7,735,334	B2 *	6/2010	Johnson	.....	62/457.4
2003/0168371	A1 *	9/2003	Weimer	.....	206/457
2005/0279123	A1 *	12/2005	Maldonado et al.	.....	62/457.7
2008/0223862	A1 *	9/2008	Vanderberg et al.	.....	220/592.03

OTHER PUBLICATIONS

Publisher: Believed to be Gregory Doyle; Title: Gregory Doyle Products; Date: Believed to be published at least by May 9, 2011; Location: [http://gregorydoyle.com/gd\\_product.html](http://gregorydoyle.com/gd_product.html).

Publisher: Believed to be Alibaba.com; Title: BBQ Grill Cooler; Date: Believe to be published at least by May 6, 2011; Location: [http://www.alibaba.com/product-gs/363333985/BBQ\\_grill\\_cooler\\_Helmet\\_shape\\_multifunction.html](http://www.alibaba.com/product-gs/363333985/BBQ_grill_cooler_Helmet_shape_multifunction.html).

Publisher: Believed to be MDA Dallas; Title: North Texas Online Auction; Date: Believed to be published at least by Sep. 16, 2010; Location: [http://www.biddingforgood.com/auction/item/Item.action;jsessionid=EOKJwMPOZ0BuePGezUbIEQ\\*\\*.asp2-i?id=117369035](http://www.biddingforgood.com/auction/item/Item.action;jsessionid=EOKJwMPOZ0BuePGezUbIEQ**.asp2-i?id=117369035).

\* cited by examiner

*Primary Examiner* — Terry Wallace

(74) *Attorney, Agent, or Firm* — Pamela A. Baxter; Kean Miller LLP

(57) **CLAIM**

The ornamental design for a helmet shaped cooler, as shown and described.

**DESCRIPTION**

FIG. 1 is a right side perspective view of the helmet shaped cooler with the handle extended. The left side perspective view is a mirror image.

FIG. 2 is a right side elevation view thereof; the left side view is a mirror image.

FIG. 3 is a front view thereof.

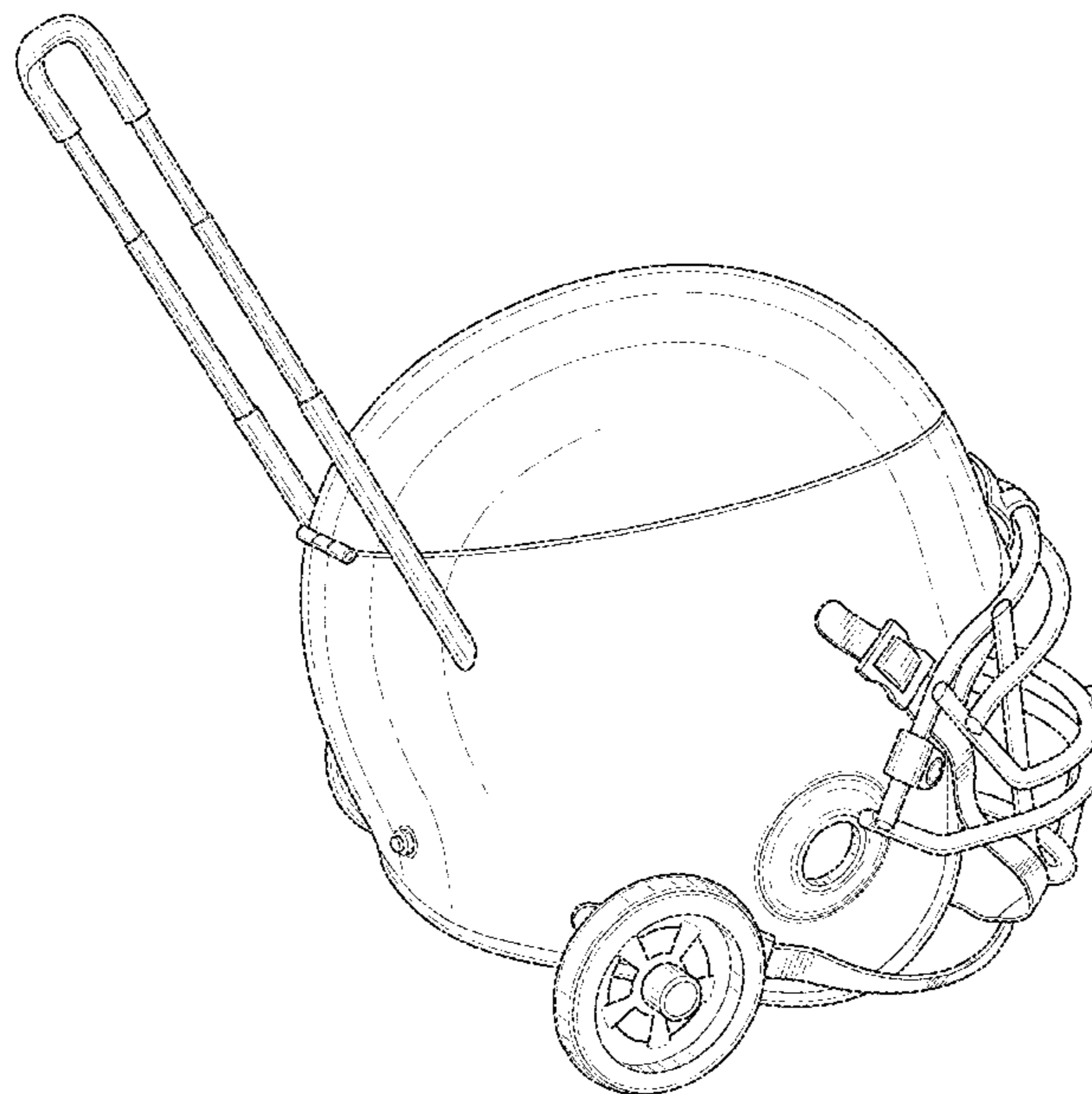
FIG. 4 is a rear view thereof.

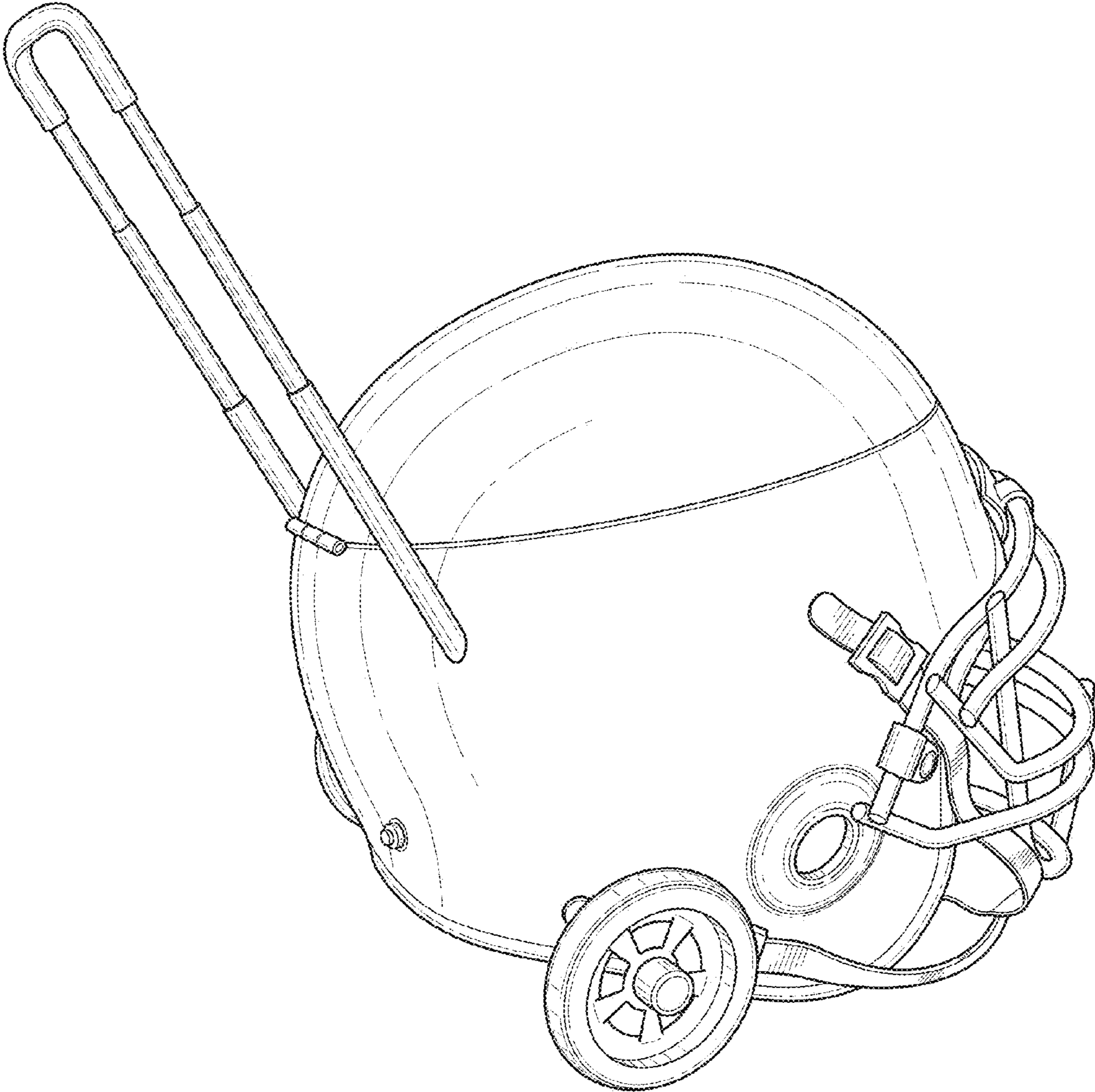
FIG. 5 is a top plan view thereof; and,

FIG. 6 is a right side perspective view thereof with the lid raised and the handles extended. The left side perspective view is a mirror image; and,

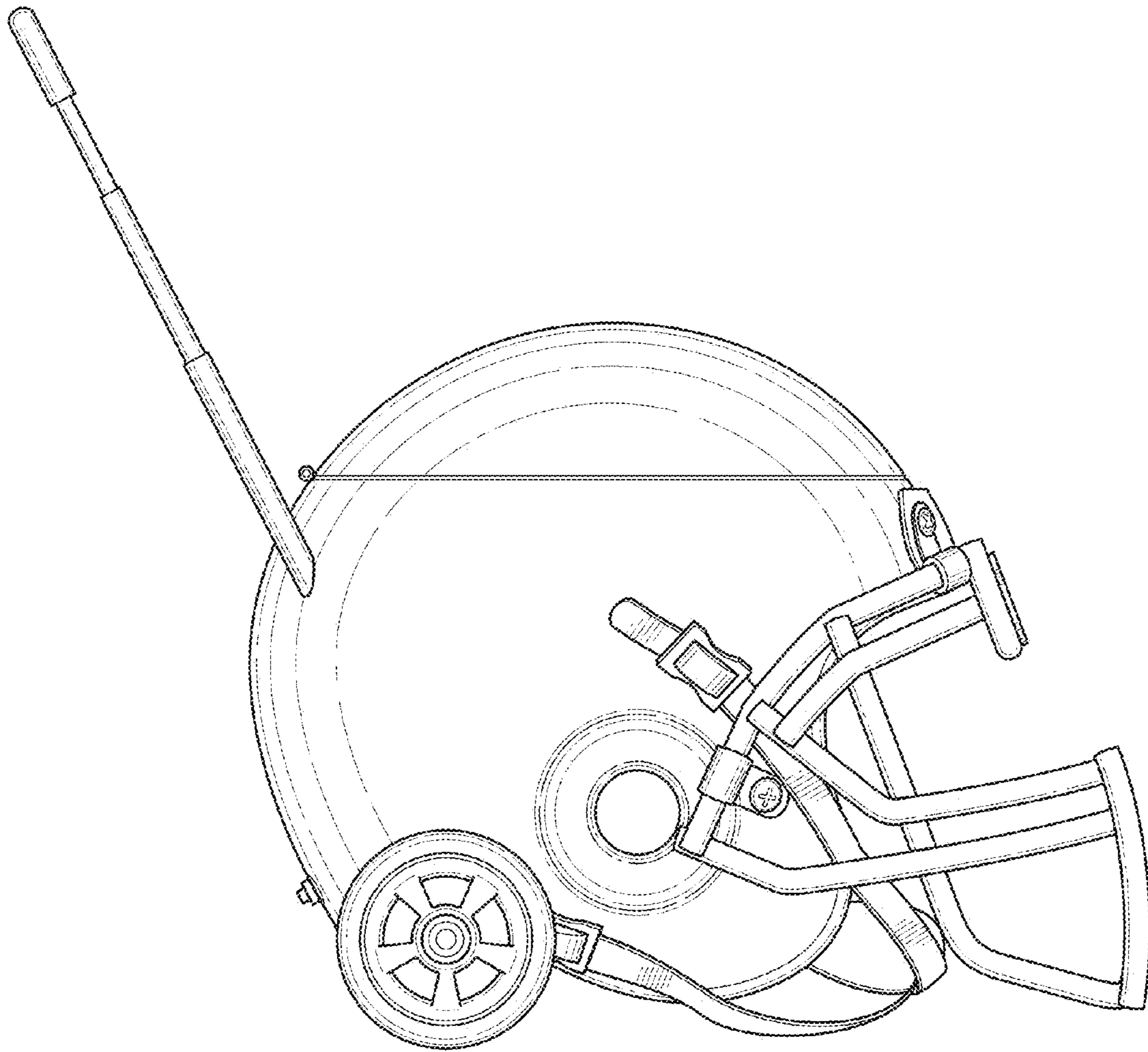
FIG. 7 is a right side perspective view thereof with the handle retracted. The left side perspective view is a mirror image.

**1 Claim, 7 Drawing Sheets**

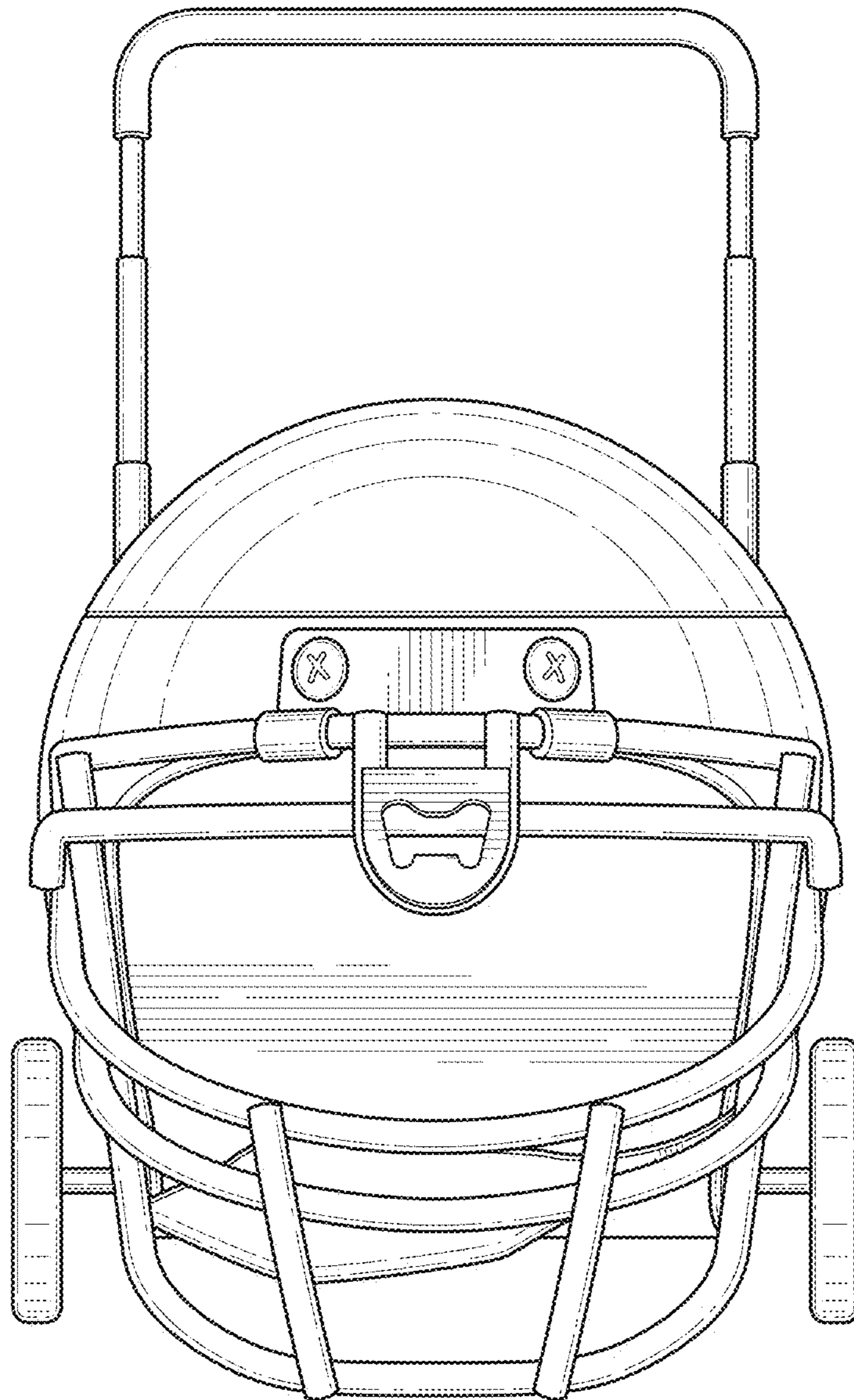




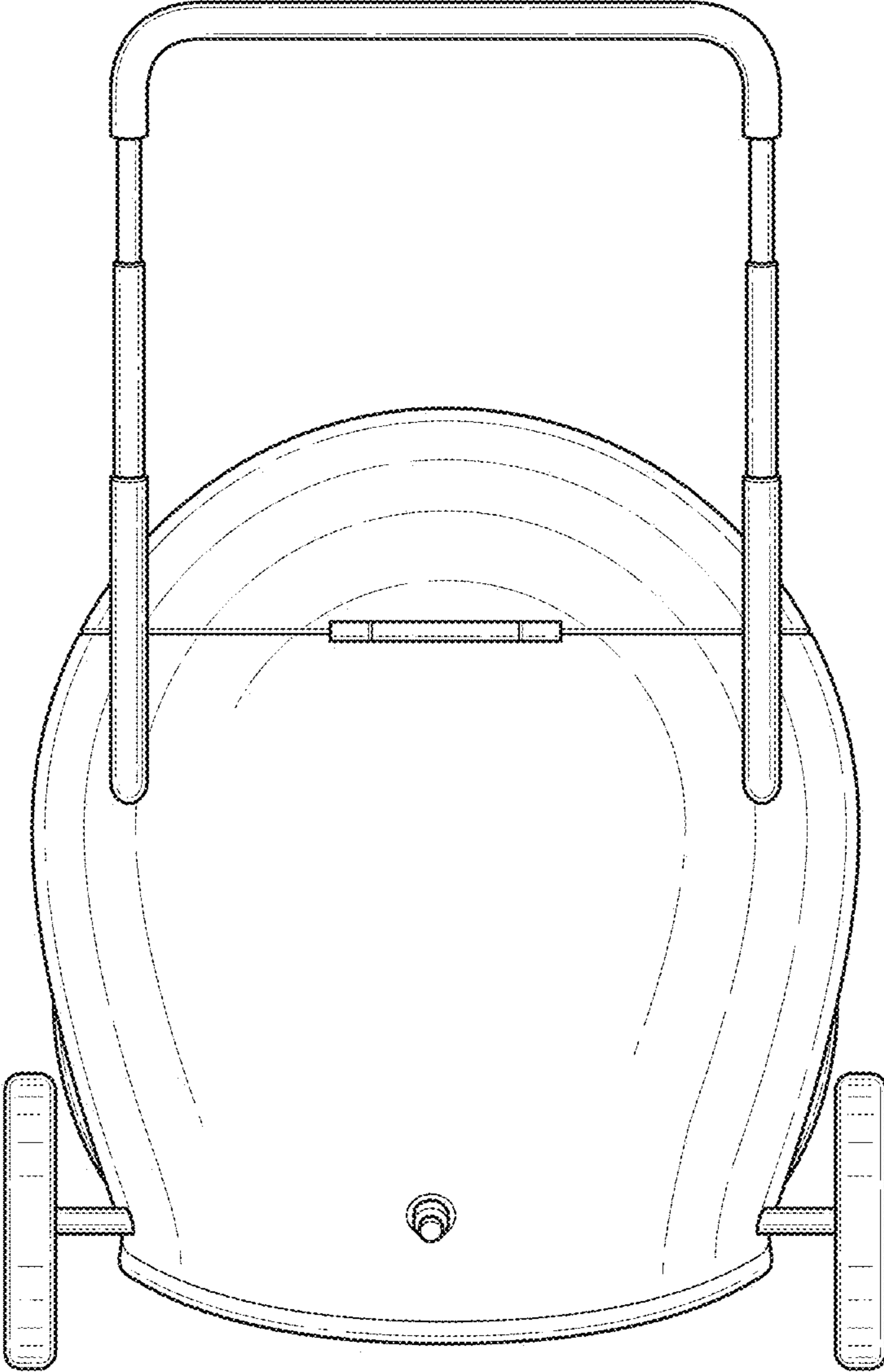
**FIG. 1**



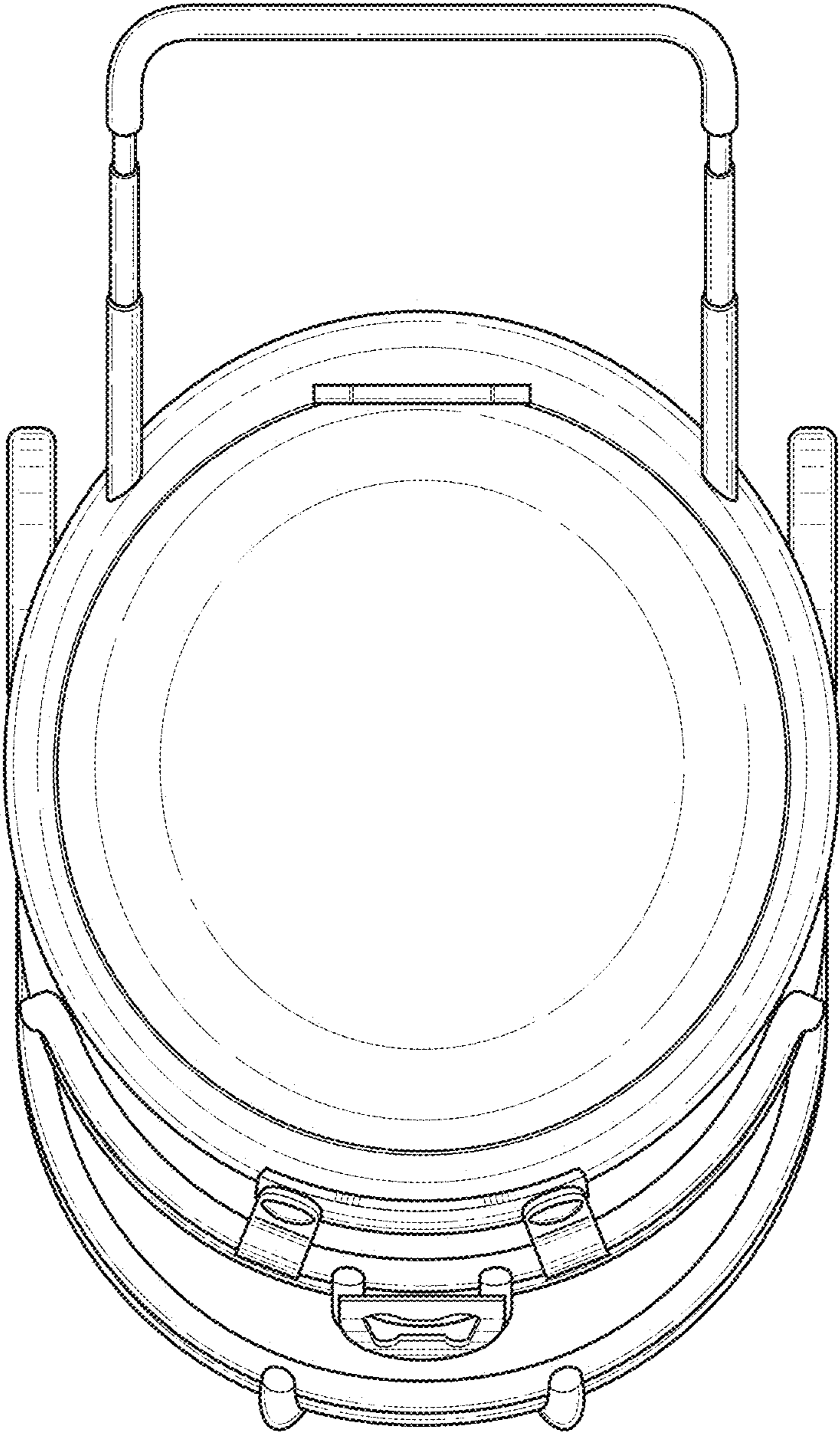
**FIG. 2**



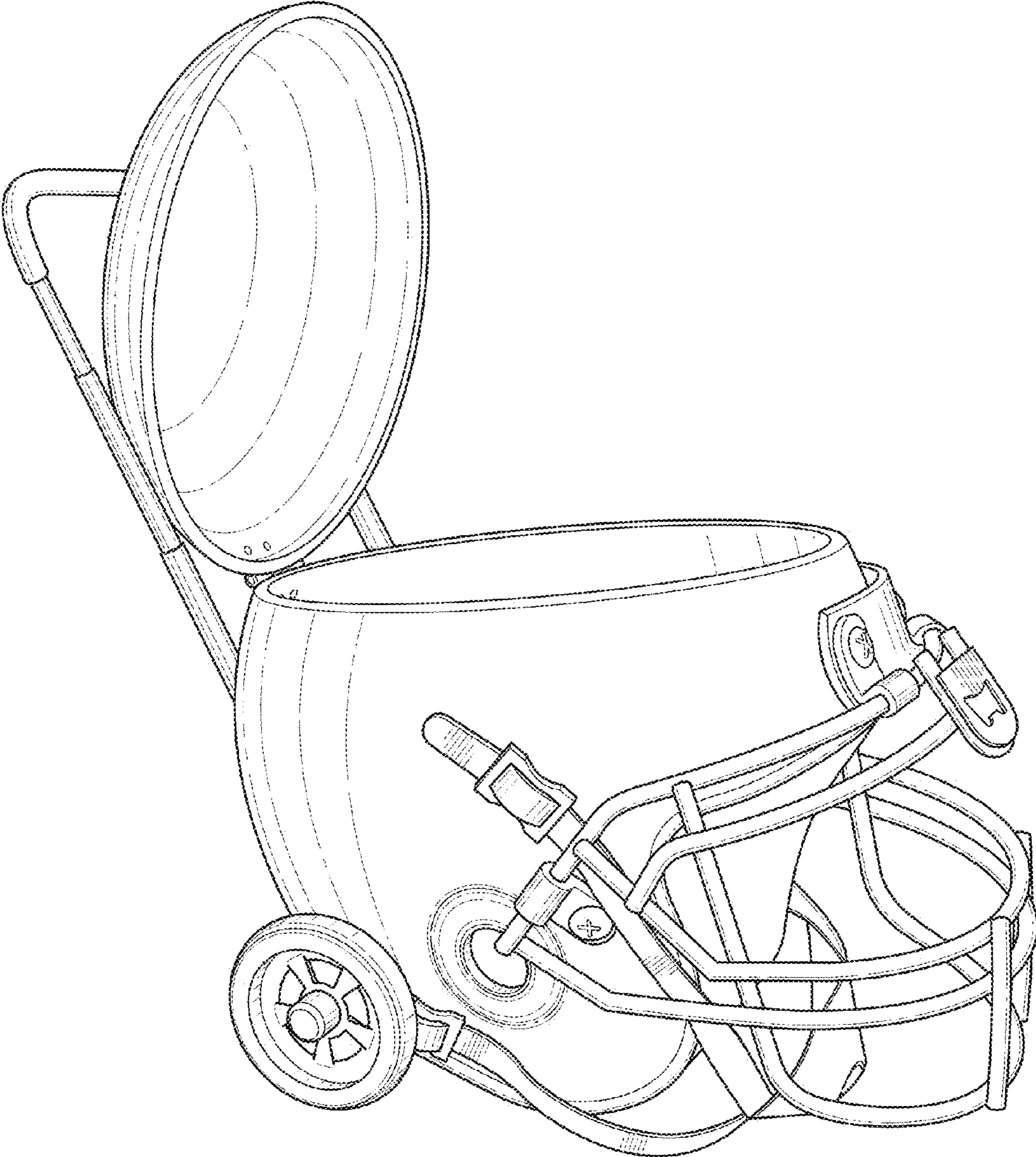
**FIG. 3**



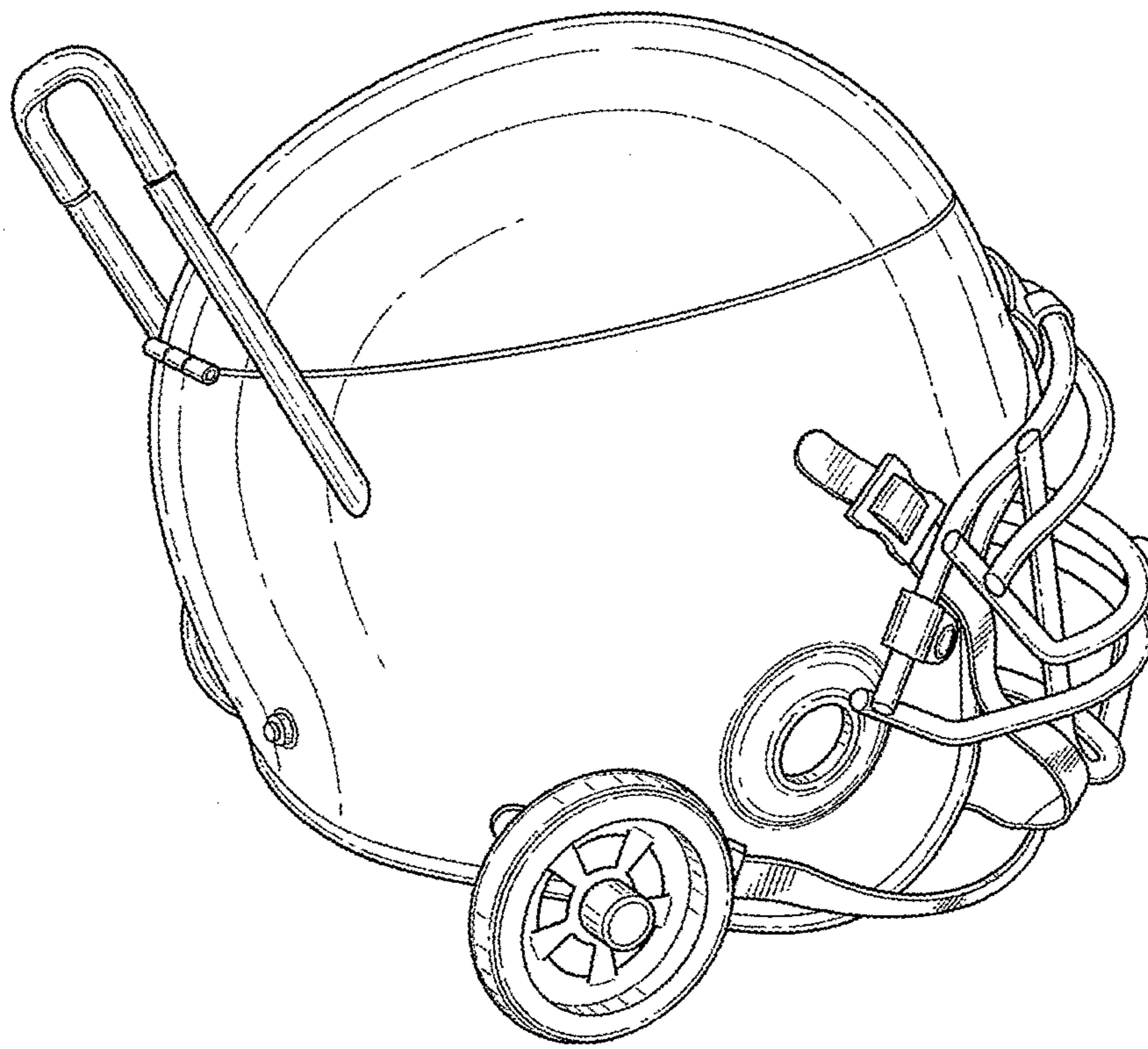
**FIG. 4**



**FIG. 5**



**FIG. 6**



**FIG. 7**