



US00D685218S

(12) **United States Design Patent**
Willat et al.

(10) **Patent No.:** **US D685,218 S**
(45) **Date of Patent:** **** Jul. 2, 2013**

(54) **DECANTER**
(75) Inventors: **Boyd I. Willat**, Venice, CA (US);
Joseph T. Perrulli, St. Helena, CA (US)
(73) Assignee: **By The Glass, LLC**, Los Angeles, CA
(US)

(**) Term: **14 Years**

(21) Appl. No.: **29/411,856**

(22) Filed: **Jan. 26, 2012**

(51) **LOC (9) Cl.** **07-01**

(52) **U.S. Cl.**
USPC **D7/316; D7/598**

(58) **Field of Classification Search**
USPC D7/316, 598, 600, 300, 317, 318,
D7/319; D9/500, 538; D11/146, 152, 153;
222/146.6
See application file for complete search history.

(56) **References Cited**

U.S. PATENT DOCUMENTS

D181,301 S * 10/1957 Loewy D7/300
D214,831 S * 8/1969 Lomont D7/598
D230,689 S * 3/1974 Schweizer D7/598
D295,145 S * 4/1988 Jeanjean D7/300
D403,833 S * 1/1999 Mertins, Jr. D99/34
D542,707 S * 5/2007 Kolokotronis et al. D11/153
D567,566 S * 4/2008 Beha D7/316

D577,547 S * 9/2008 Willat et al. D7/523
D612,659 S * 3/2010 Kehoe D7/316
D635,403 S * 4/2011 Conway et al. D7/598
D646,926 S * 10/2011 Willat et al. D7/509
D658,924 S * 5/2012 Sabadicci D7/316
D671,786 S * 12/2012 Lin D7/300.1
2006/0249518 A1* 11/2006 Festa 220/669

* cited by examiner

Primary Examiner — Marianne Pandozzi

(74) *Attorney, Agent, or Firm* — Lowry Blixseth LLP; Scott M. Lowry

(57) **CLAIM**

The ornamental design for a decanter, as shown and described.

DESCRIPTION

FIG. 1 is a perspective view showing the front, top and right sides of the decanter;
FIG. 2 is a front elevation view of the decanter;
FIG. 3 is a rear elevation view of the decanter;
FIG. 4 is a left side elevation view, the right side being a mirror image of the left side as shown;
FIG. 5 is a top plan view of the decanter;
FIG. 6 is a bottom plan view of the decanter;
FIG. 7 is a cross-sectional view of the decanter, taken about the line 7-7 of FIG. 2; and,
FIG. 8 is an enlarged cross-sectional view taken about the circle 8 of FIG. 7, further illustrating an inwardly projecting drip resistant lip of the decanter.

1 Claim, 2 Drawing Sheets

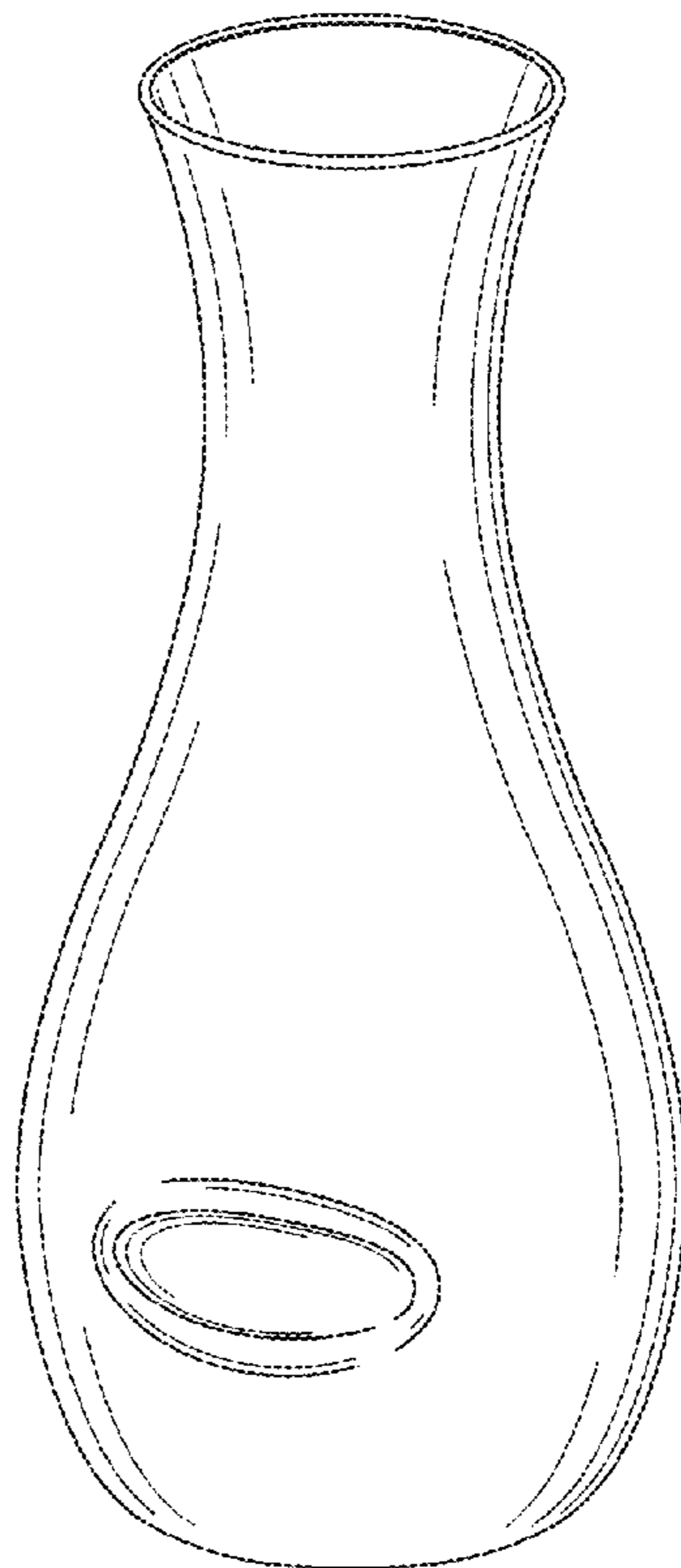

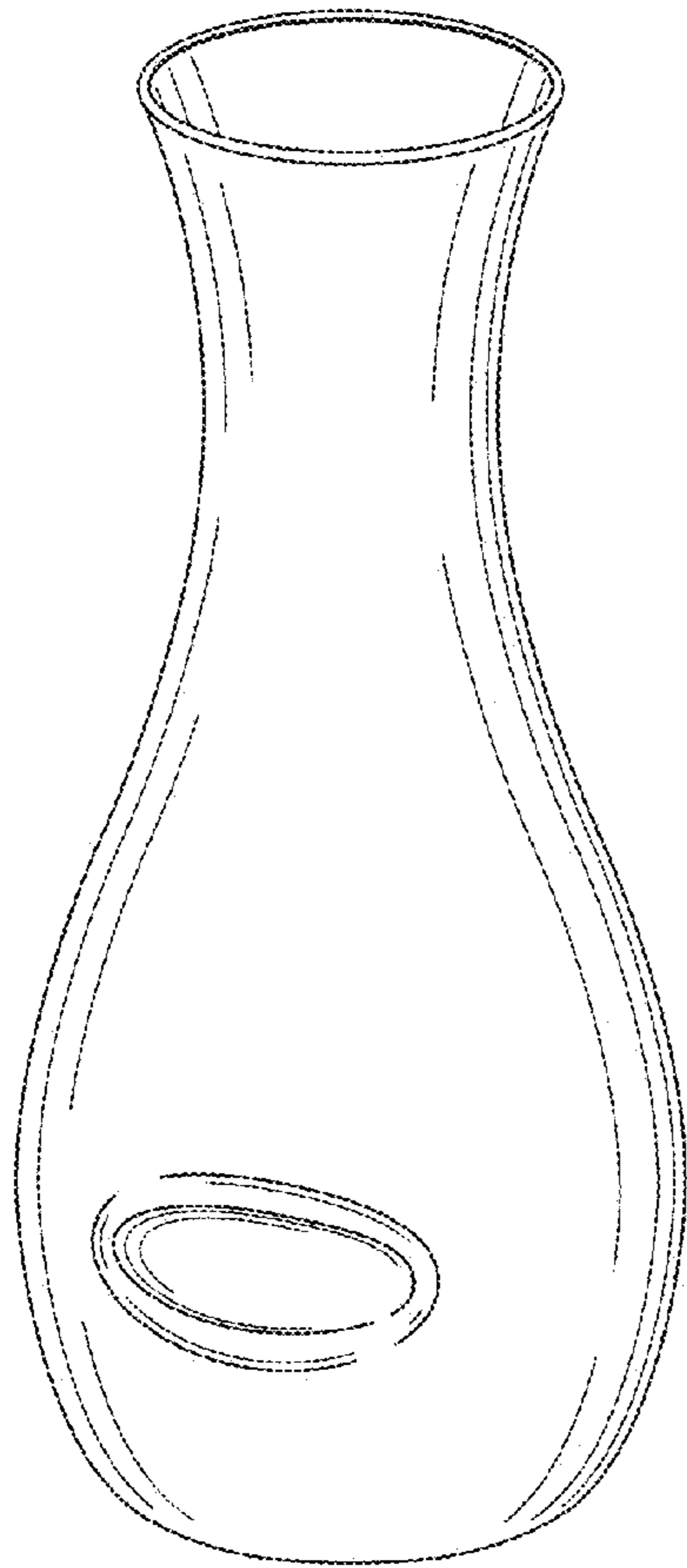
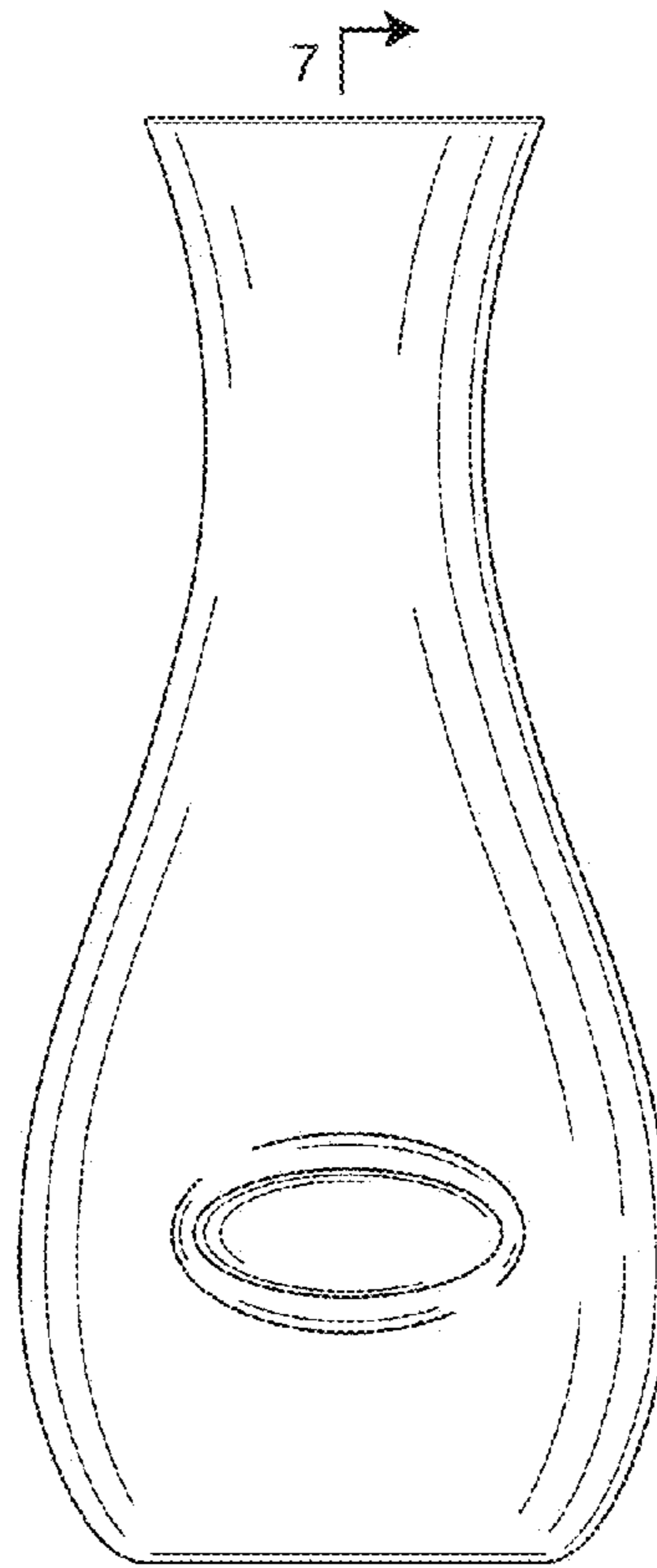

FIG. 1



7L →
FIG. 2

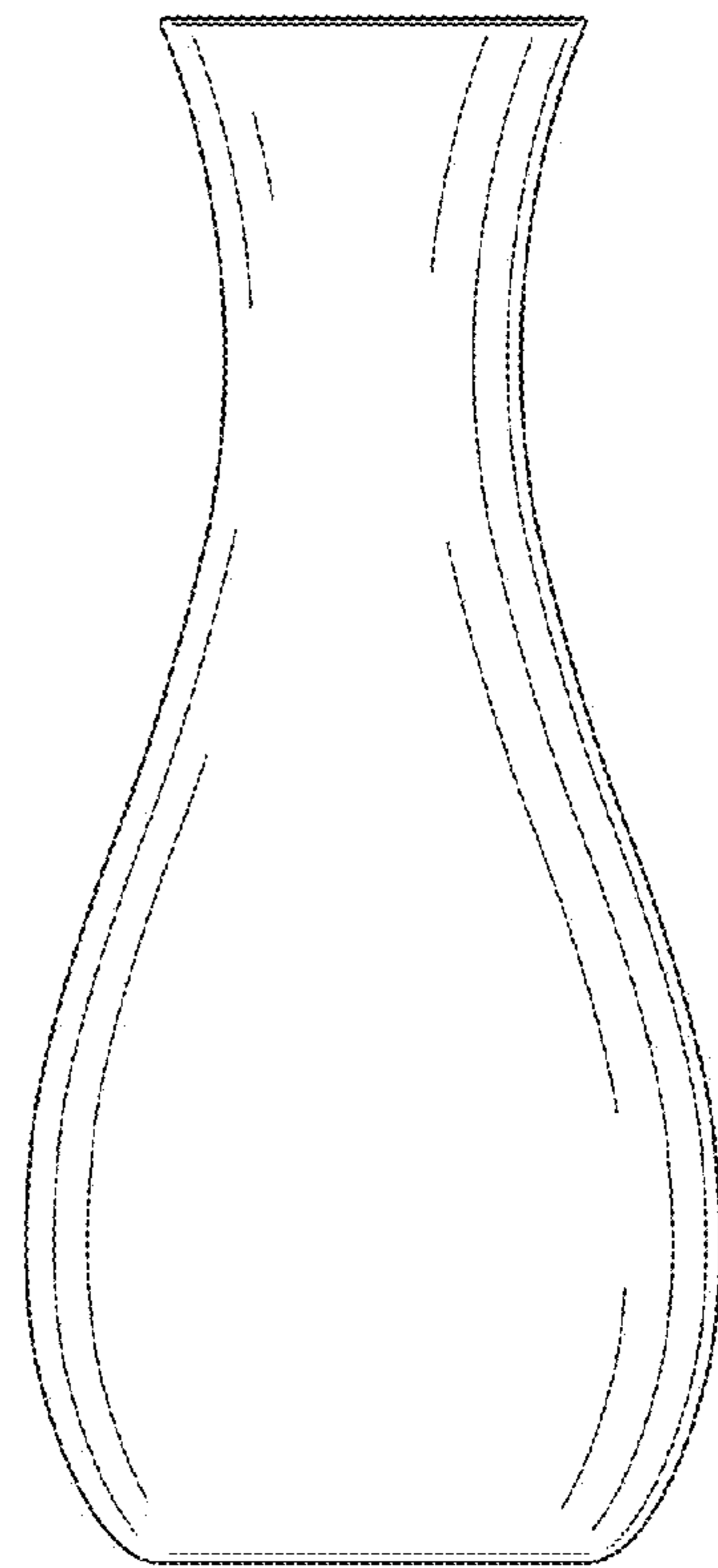

FIG. 3

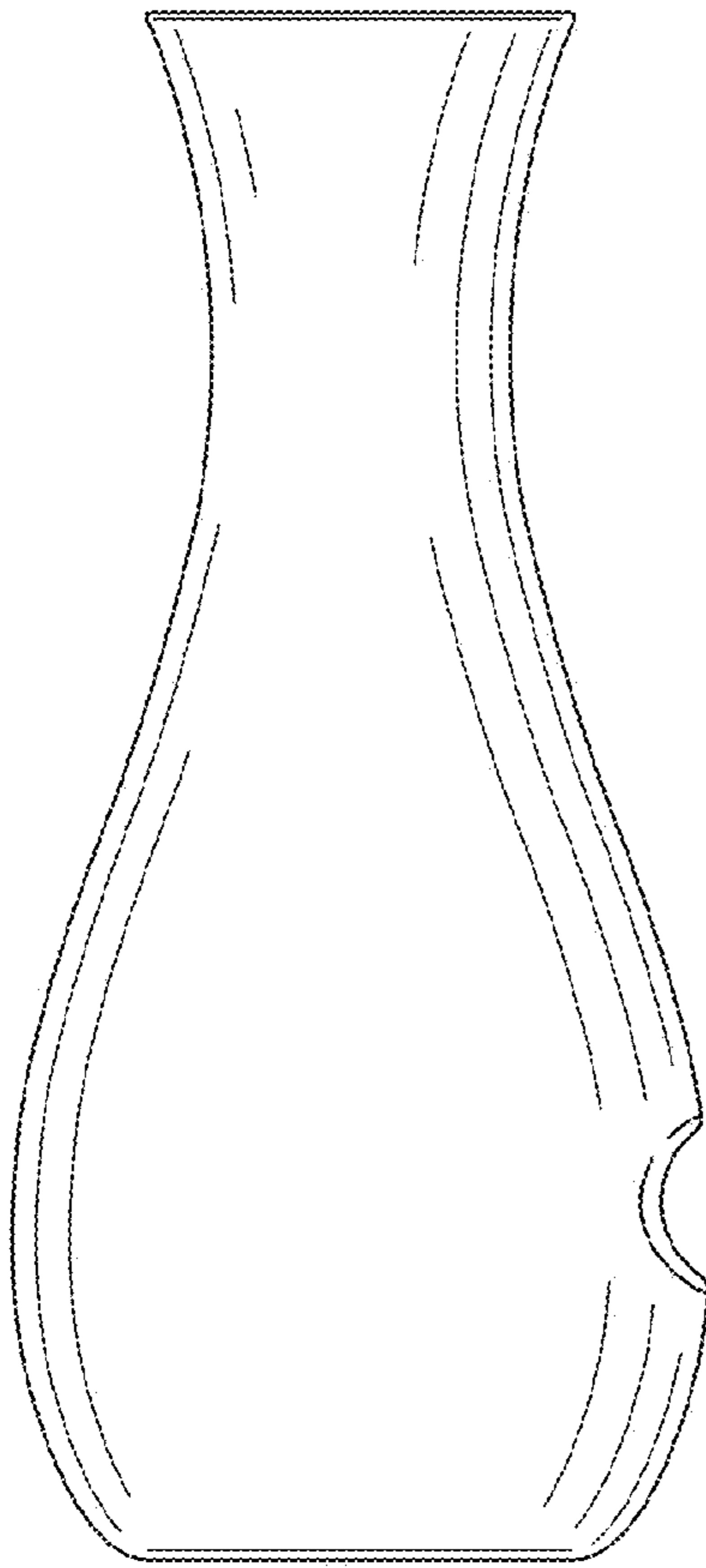

FIG. 4

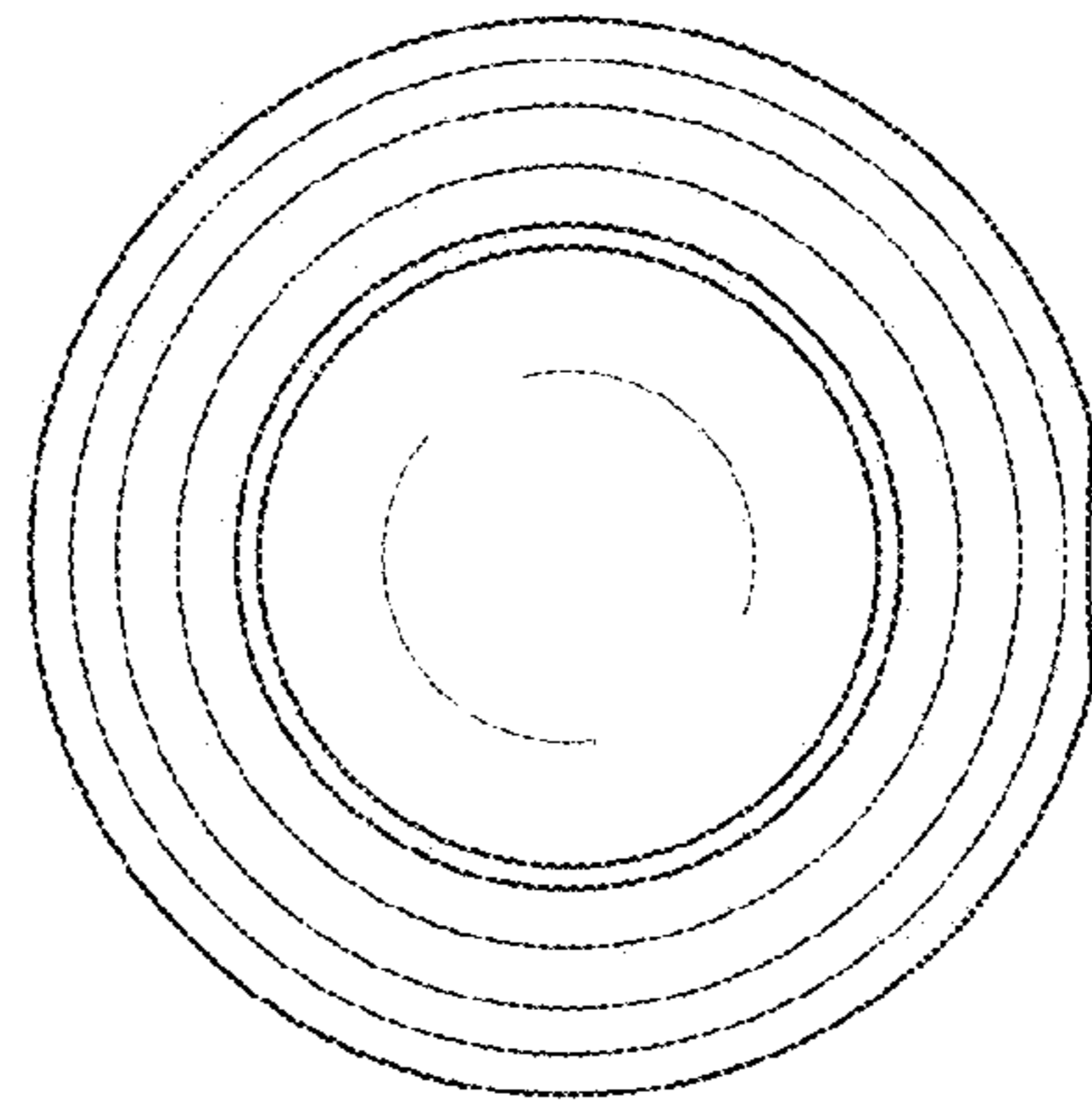

FIG. 5

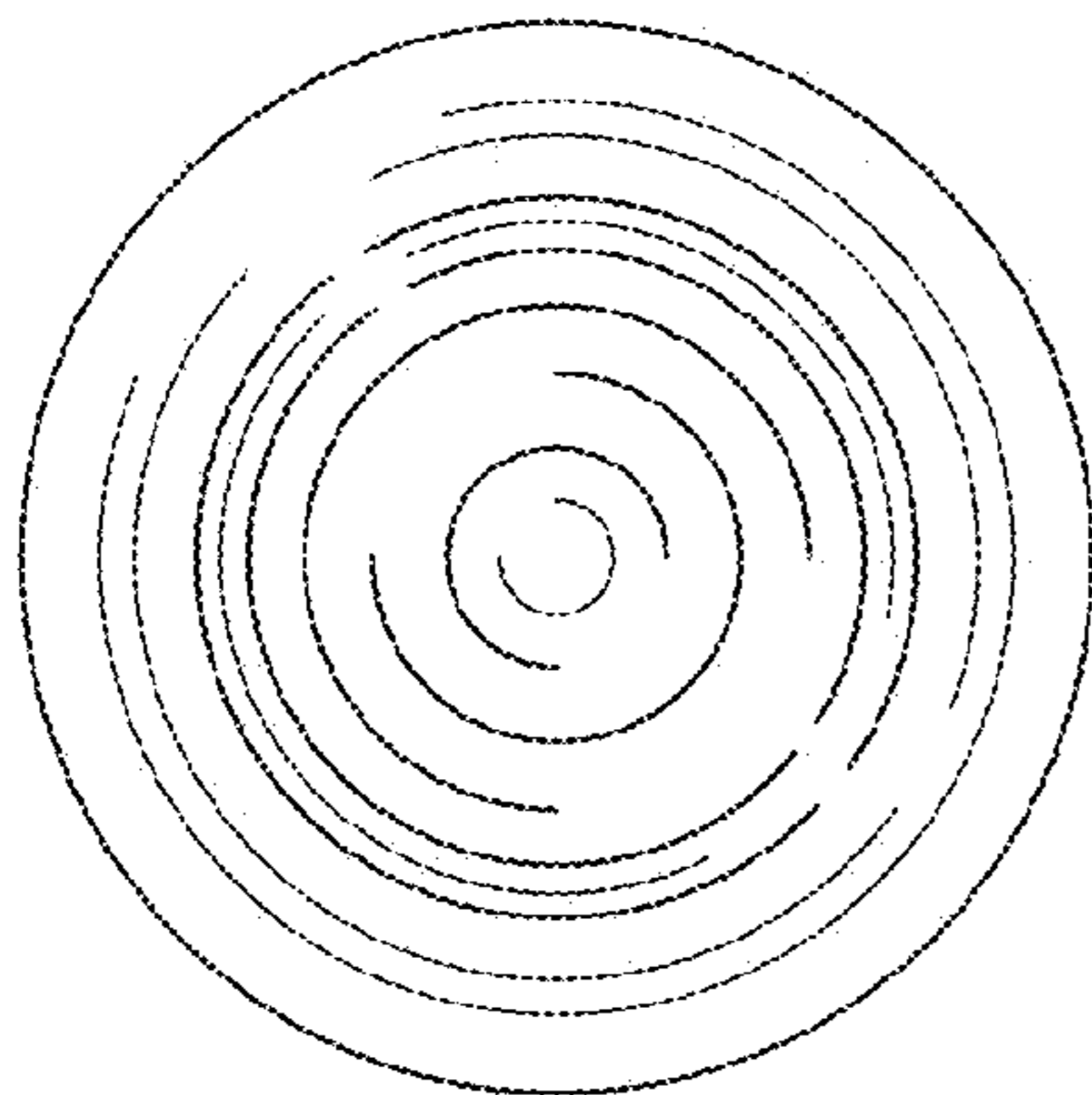

FIG. 6

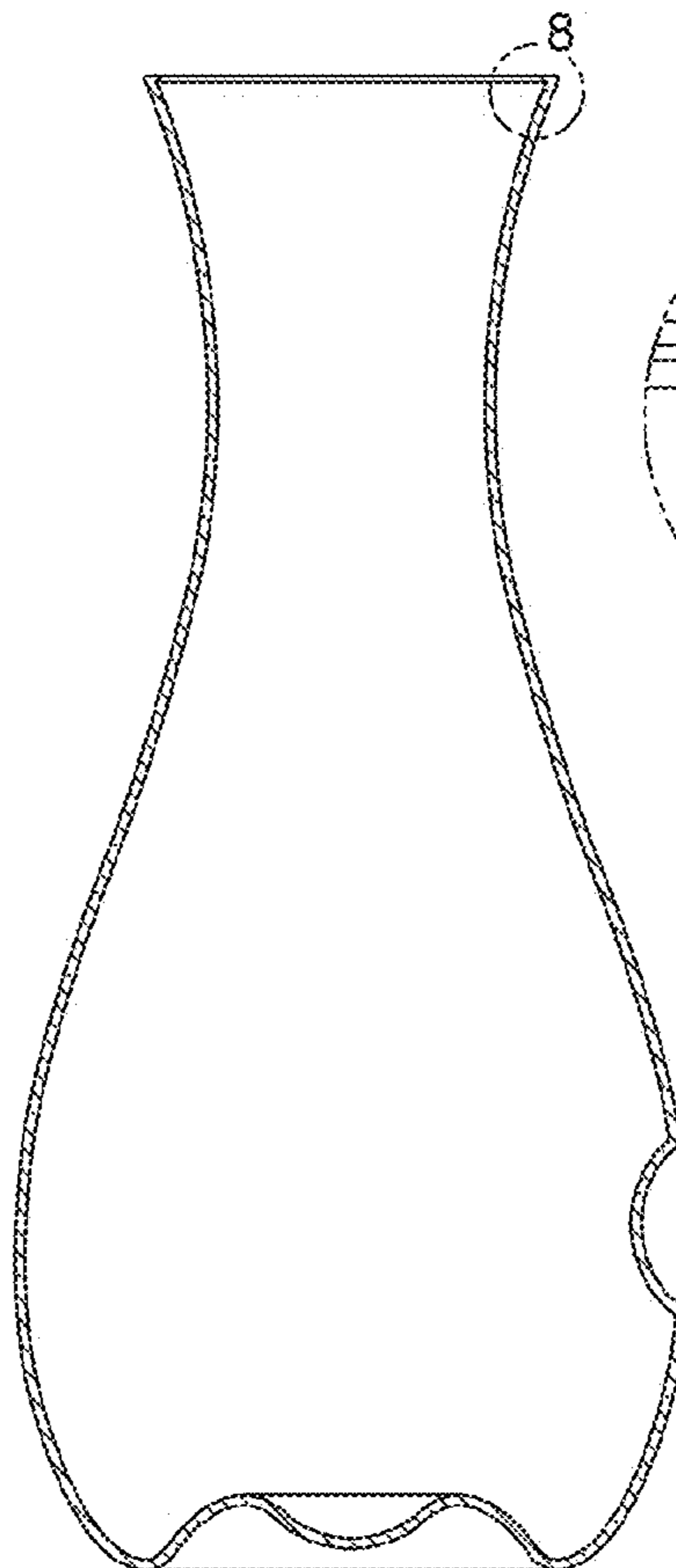

FIG. 7

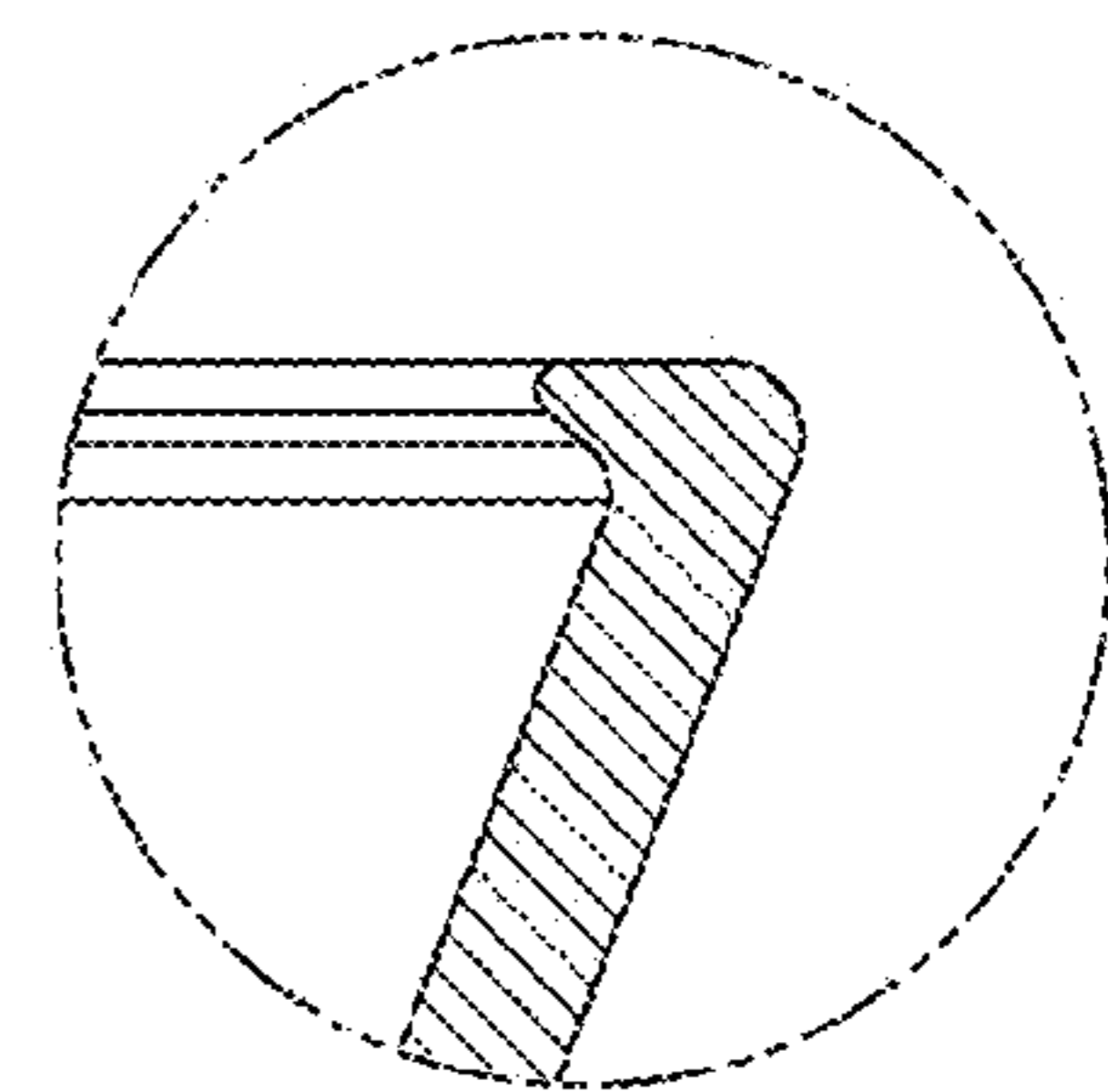

FIG. 8