



US00D685185S

(12) **United States Design Patent**  
**Bulzis**

(10) **Patent No.:** **US D685,185 S**

(45) **Date of Patent:** **\*\* Jul. 2, 2013**

(54) **CASE FOR GLASSES**

**FOREIGN PATENT DOCUMENTS**

(76) **Inventor:** **Christopher Bulzis**, Bradenton, FL (US)

CN	201015459	2/2008
CN	201097742	8/2008
CN	201131403	10/2008
CN	201192148	2/2009
JP	2006326238	12/2006

(\*) **Notice:** This patent is subject to a terminal disclaimer.

\* cited by examiner

(\*\*) **Term:** **14 Years**

*Primary Examiner* — Holly Baynham

*Assistant Examiner* — Michelle E Wilson

(21) **Appl. No.:** **29/360,711**

(74) *Attorney, Agent, or Firm* — Charles J. Prescott, P.A.

(22) **Filed:** **Apr. 29, 2010**

(57) **CLAIM**

(51) **LOC (9) Cl.** ..... **03-01**

The ornamental design for a case for glasses, as shown and described.

(52) **U.S. Cl.**

**DESCRIPTION**

USPC ..... **D3/266**

(58) **Field of Classification Search**

USPC ..... D3/201, 202, 229, 232, 233, 276,  
D3/272, 273, 283–287, 289; D7/603–608,  
D7/709, 710; 62/457.1–457.9, 371, 372;  
383/110, 113, 93, 109; 150/100, 103–105,  
150/107, 110, 114, 118, 119; 190/100, 103–106,  
190/109, 115; 220/592.01, 915.1, 915.2

See application file for complete search history.

FIG. 1 is a perspective view of one embodiment of a case for glasses showing my new design;  
FIG. 2 is a top plan view of FIG. 1;  
FIG. 3 is a bottom plan view of FIG. 1;  
FIG. 4 is a front elevation view of FIG. 1;  
FIG. 5 is a rear elevation view of FIG. 1;  
FIG. 6 is a left end elevation view of FIG. 1;  
FIG. 7 is a right end elevation view of FIG. 1;  
FIG. 8 is a perspective view of FIG. 1 in the open position;  
FIG. 9 is a perspective view of another embodiment of a case for glasses showing my new design;  
FIG. 10 is a top plan view of FIG. 9;  
FIG. 11 is a bottom plan view of FIG. 9;  
FIG. 12 is a front elevation view of FIG. 9;  
FIG. 13 is a rear elevation view of FIG. 9;  
FIG. 14 is a left end elevation view of FIG. 9;  
FIG. 15 is a right end elevation view of FIG. 9; and,  
FIG. 16 is a perspective view of FIG. 9 in the open position.  
The broken line showing of the interior of a case for glasses is included for the purpose of illustrating environmental structure and forms no part of the claimed design.

(56) **References Cited**

**U.S. PATENT DOCUMENTS**

2,723,745	A *	11/1955	McNeill	206/5
3,291,267	A *	12/1966	Pelavin	190/111
3,477,553	A *	11/1969	Kish, Jr.	190/119
D280,261	S	8/1985	Chuboff et al.	
4,932,506	A *	6/1990	Kim	190/111
D316,932	S *	5/1991	Escher, Jr.	D3/265
5,676,242	A	10/1997	Scott	
D452,612	S *	1/2002	Alexandroff	D3/265
D516,870	S *	3/2006	Martinez et al.	D7/607
D524,050	S *	7/2006	Suppangig	D3/289
D552,348	S *	10/2007	Martin	D3/265
D610,804	S *	3/2010	Bedingfield	D3/265
D618,966	S *	7/2010	Koehler et al.	D7/607

**1 Claim, 12 Drawing Sheets**

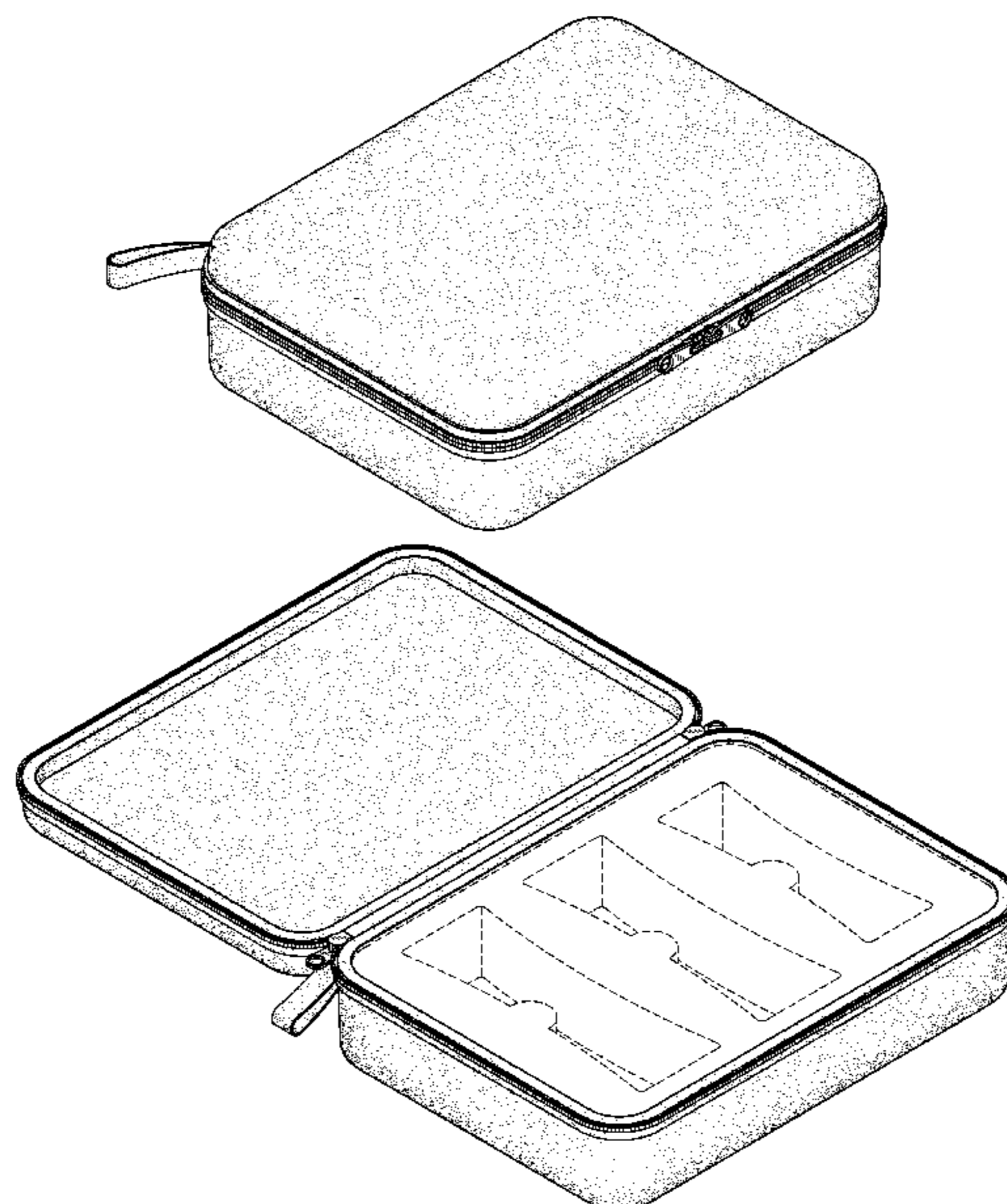

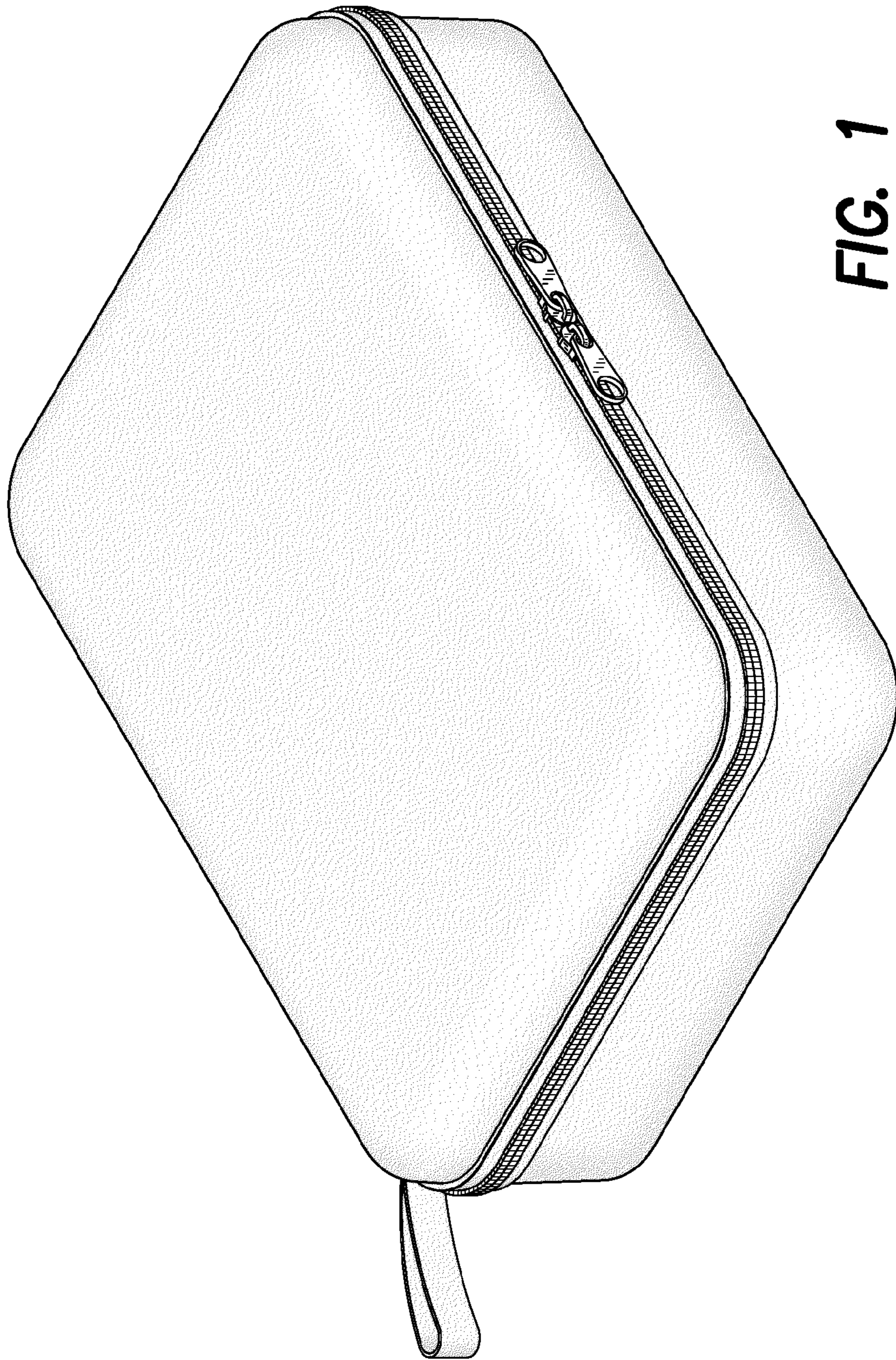
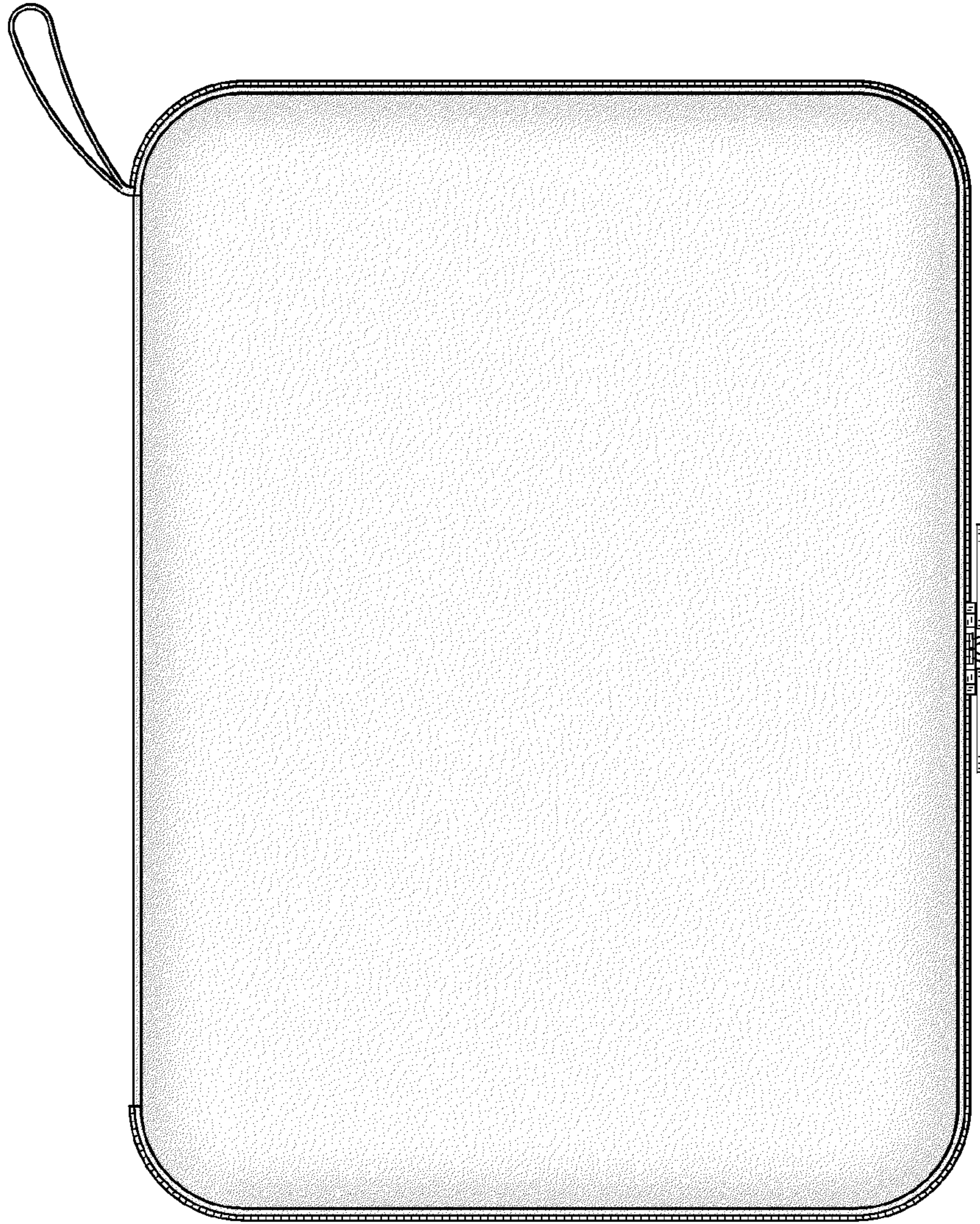

FIG. 1



**FIG. 2**



**FIG. 3**

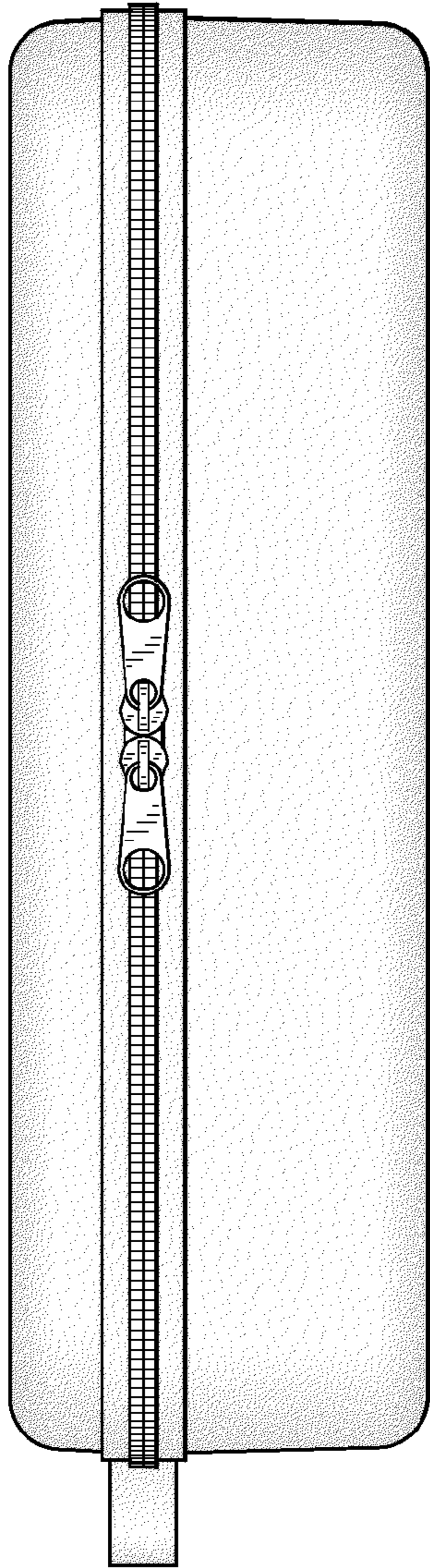

**FIG. 4**

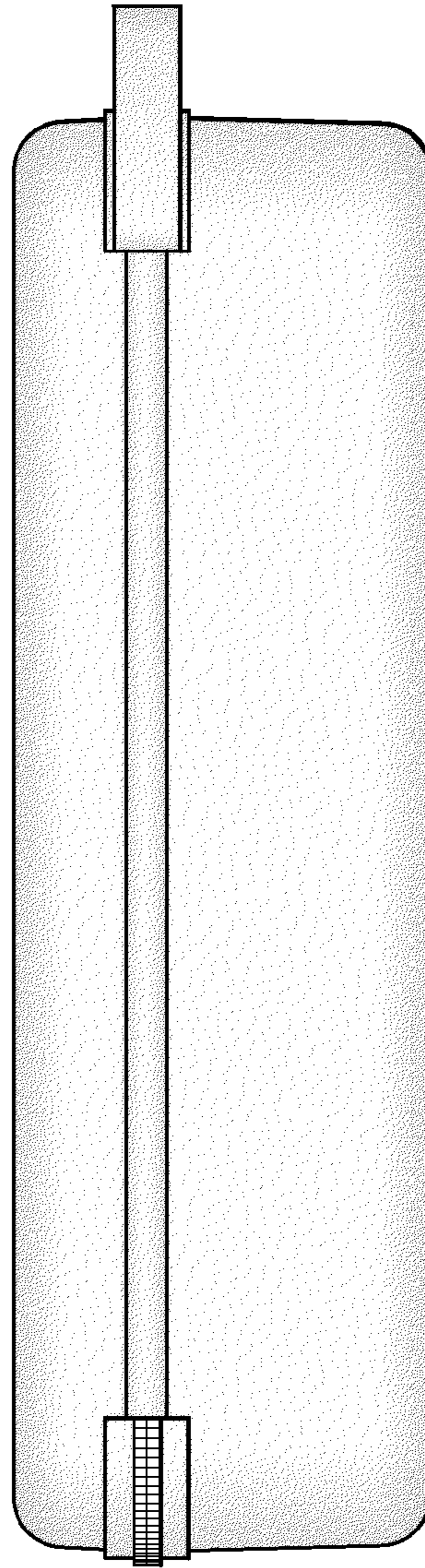

**FIG. 5**

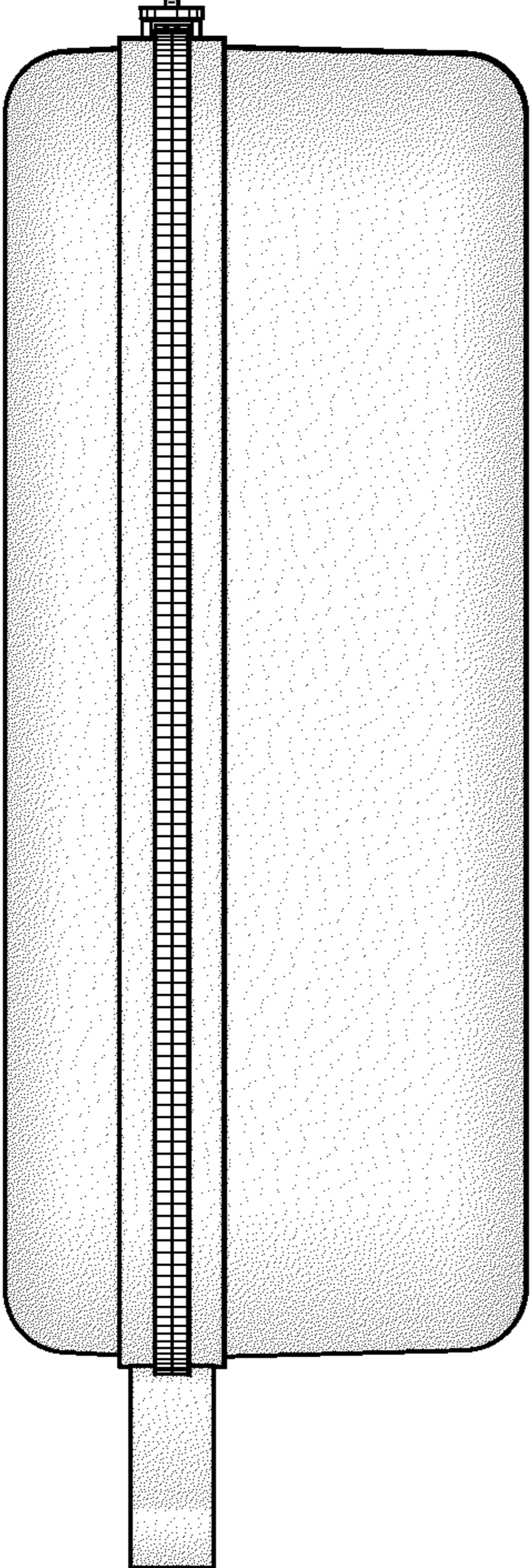

**FIG. 6**

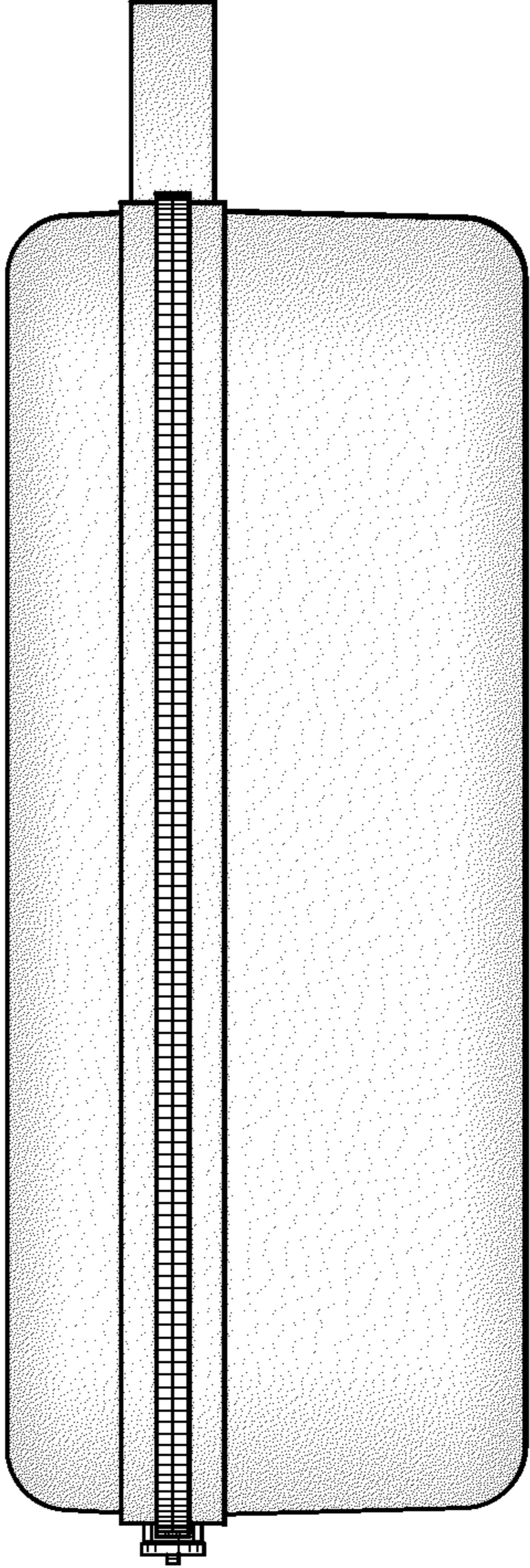

**FIG. 7**

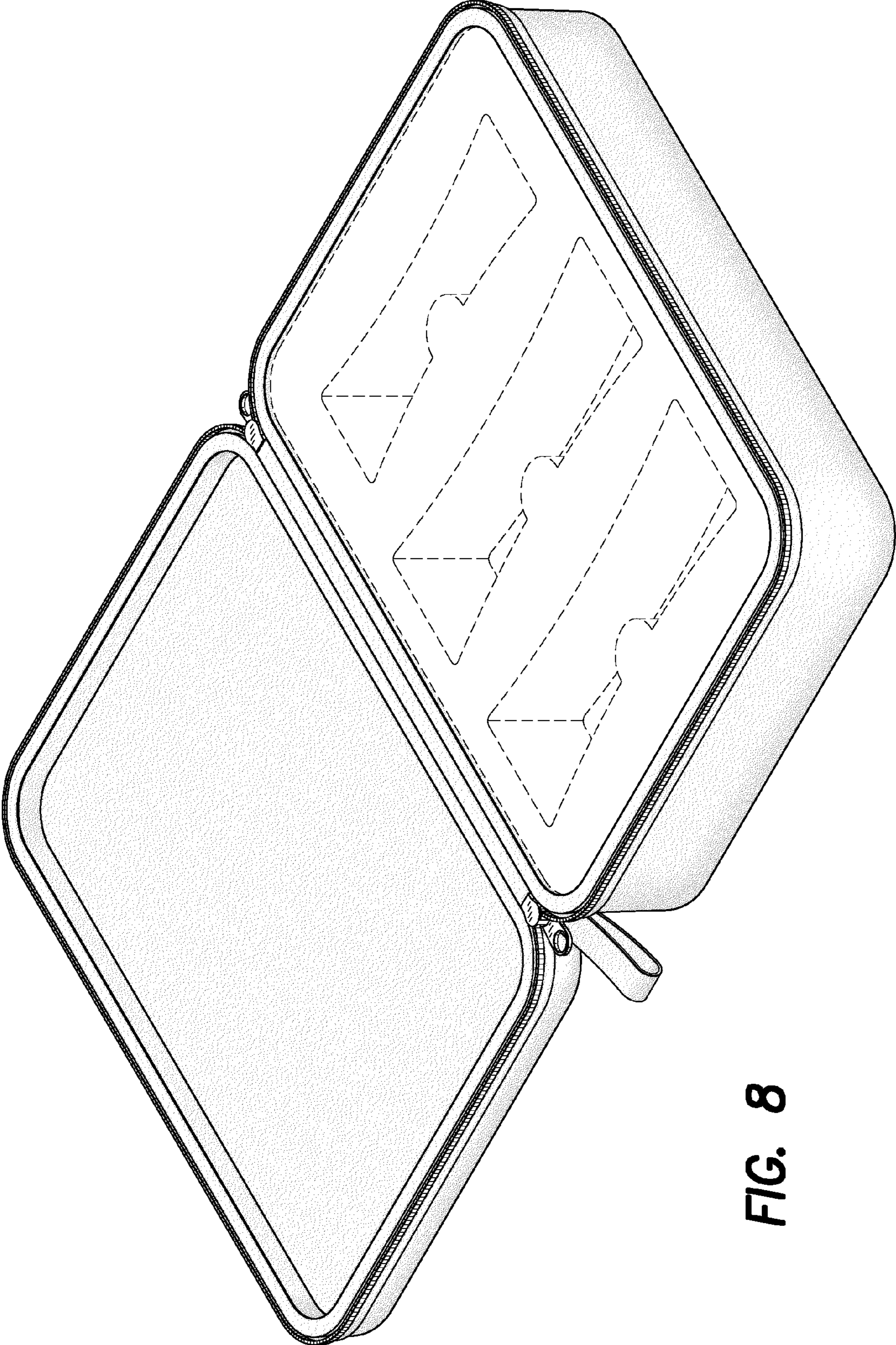
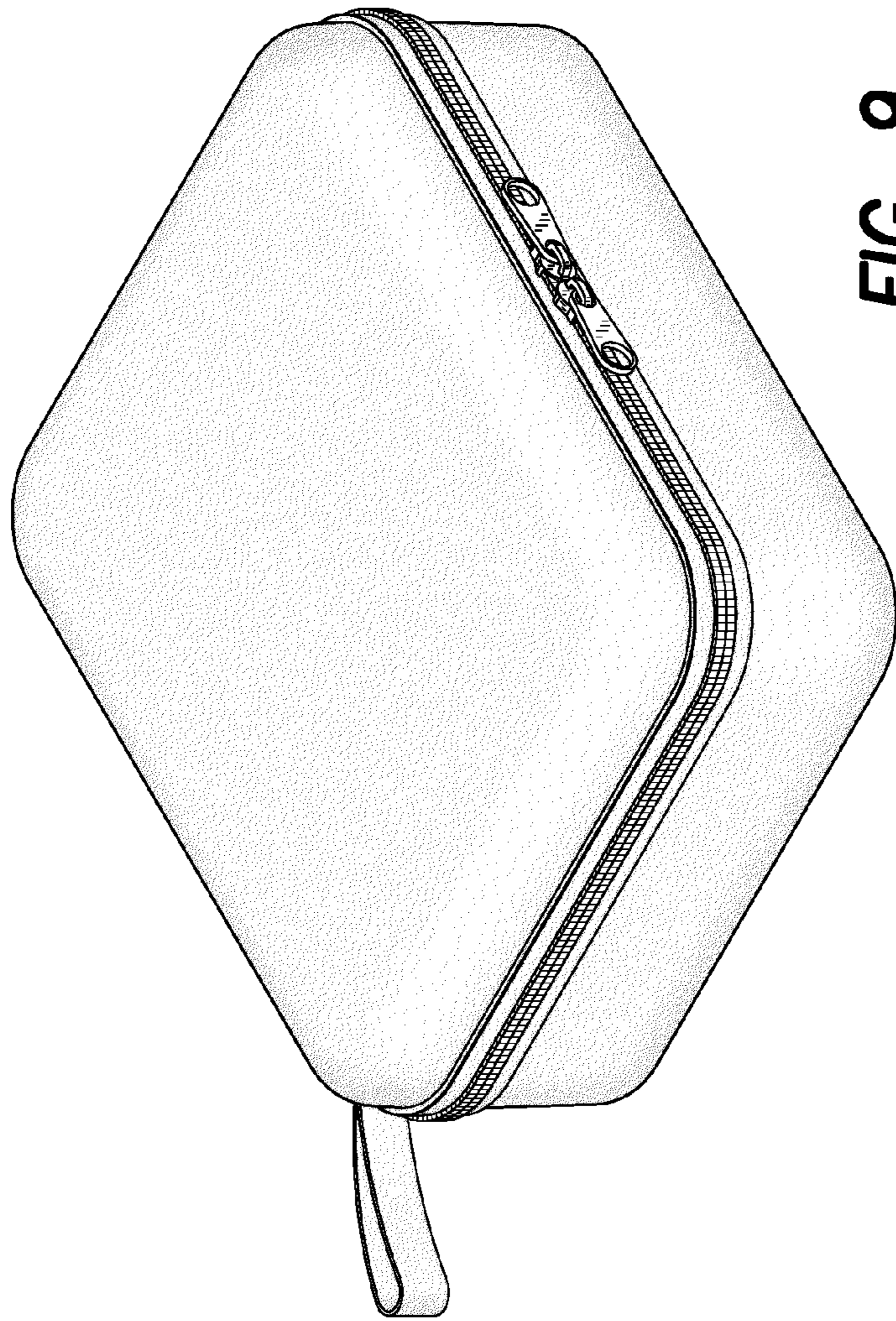
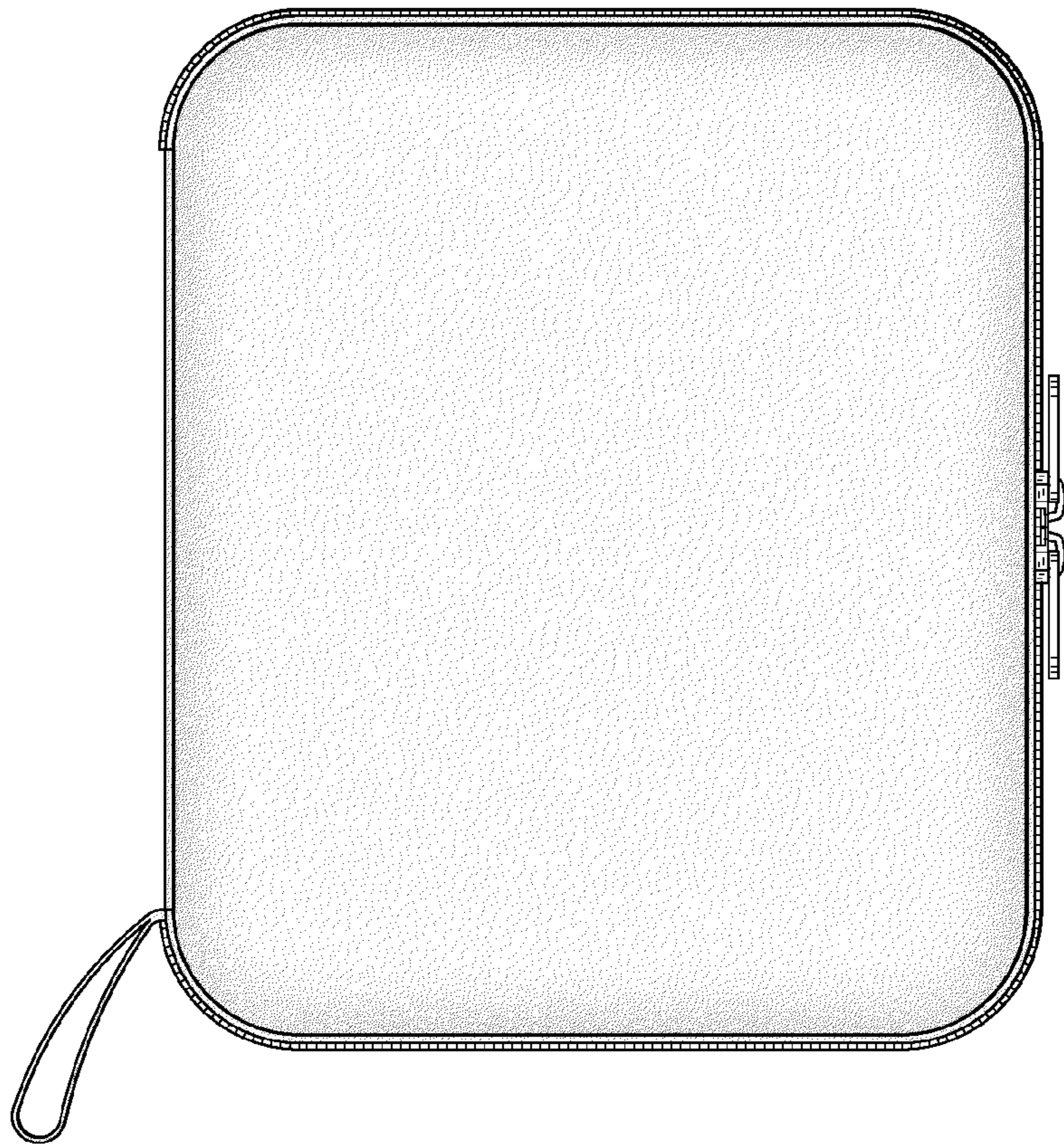

FIG. 8

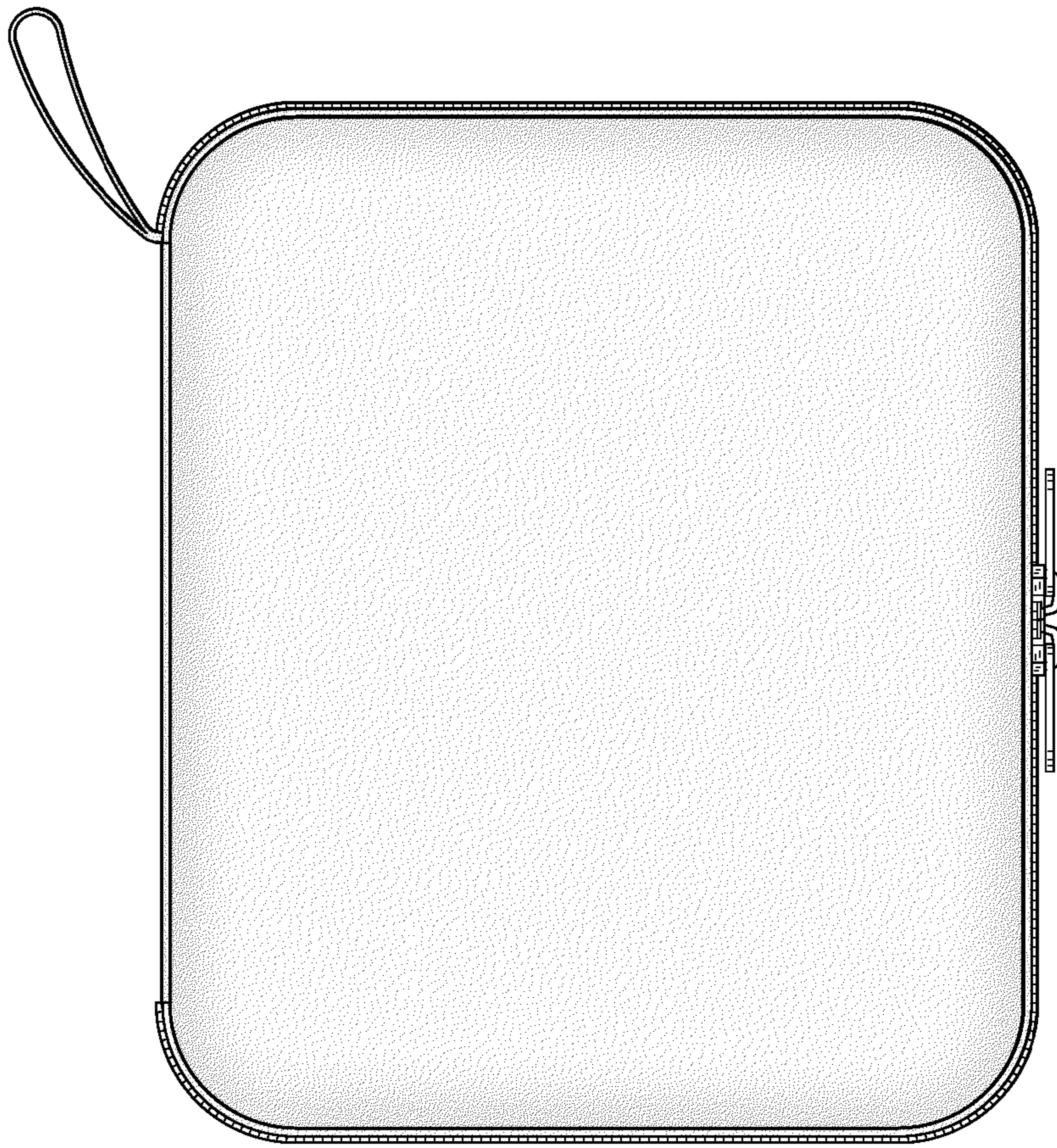

**FIG. 9**

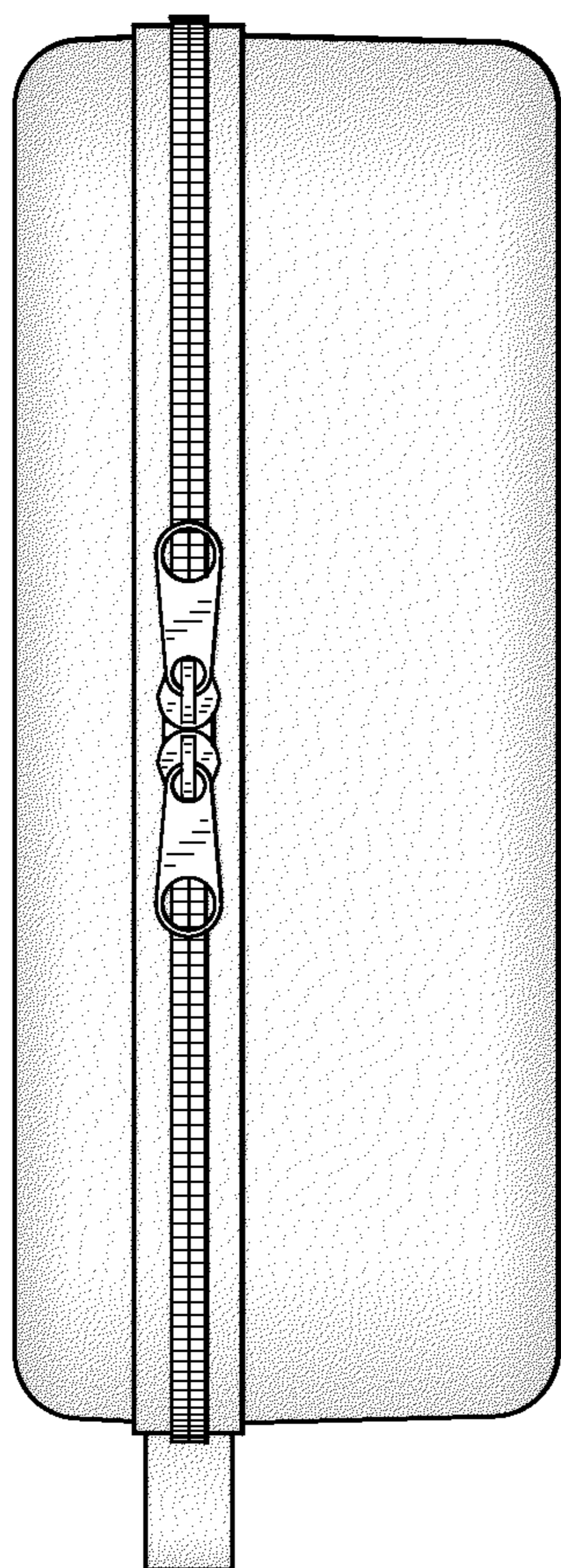



**FIG. 10**



**FIG. 11**



**FIG. 12**

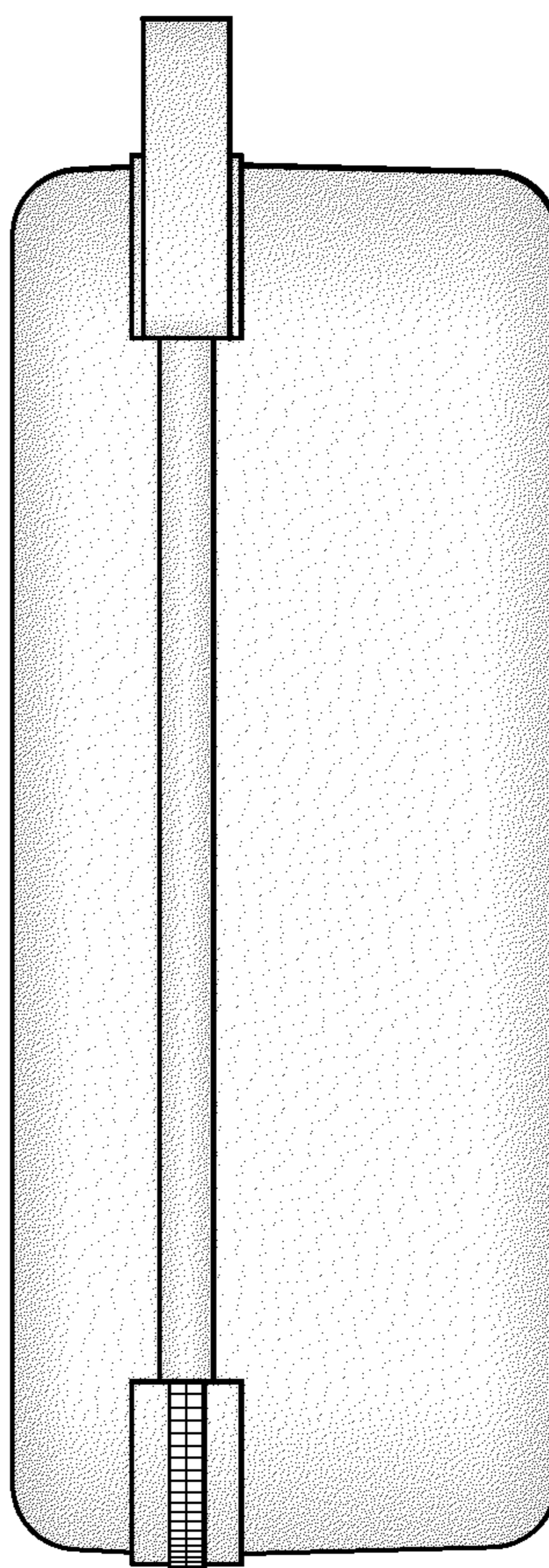

**FIG. 13**

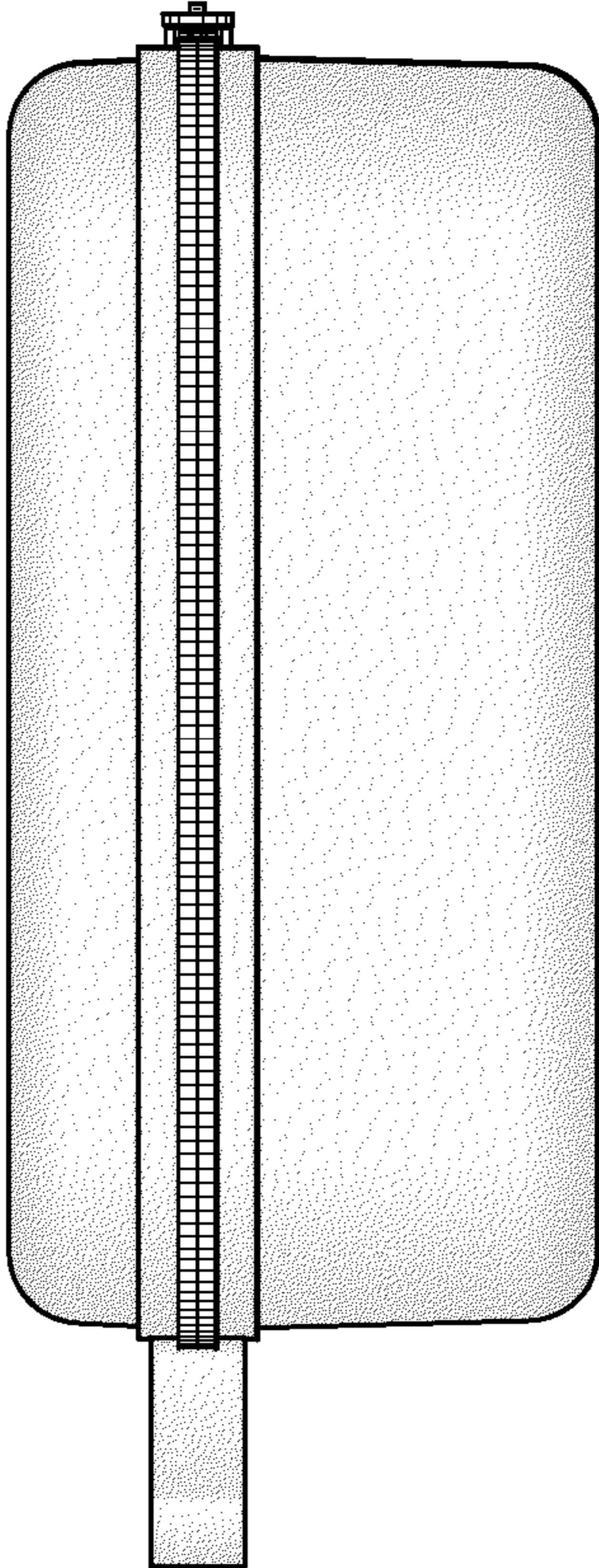

**FIG. 14**

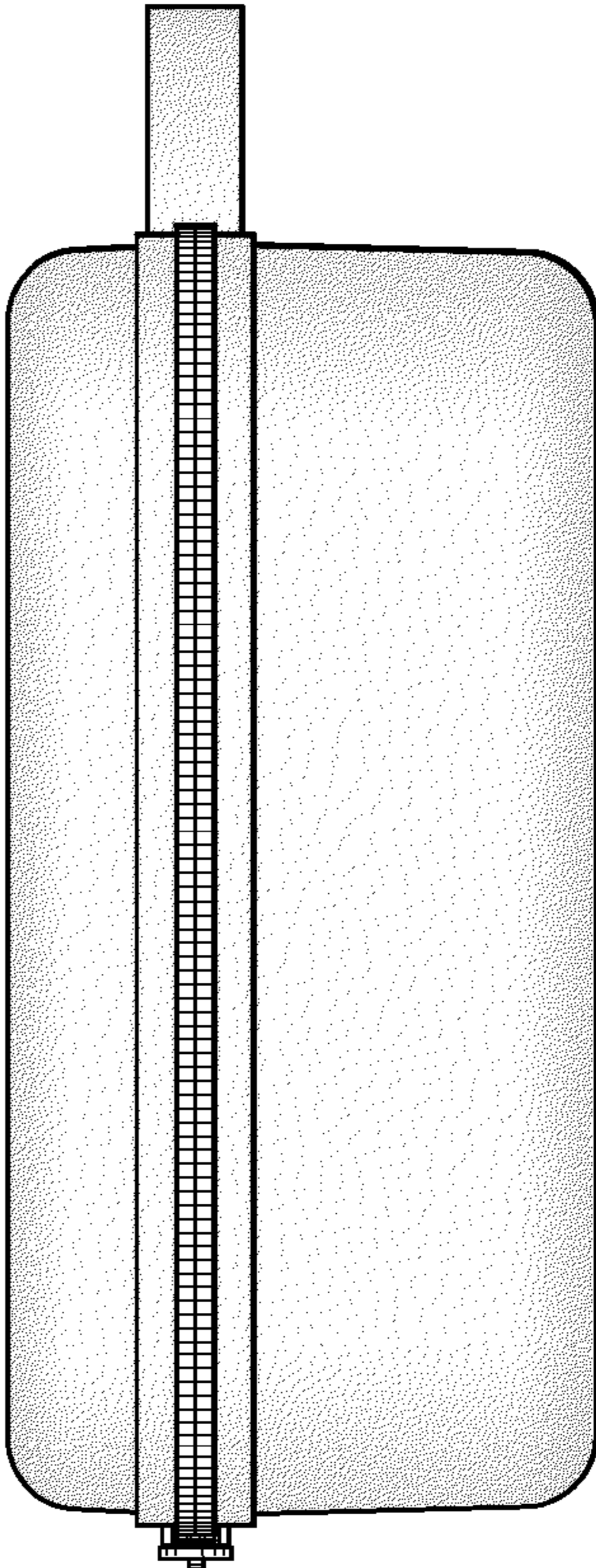

**FIG. 15**

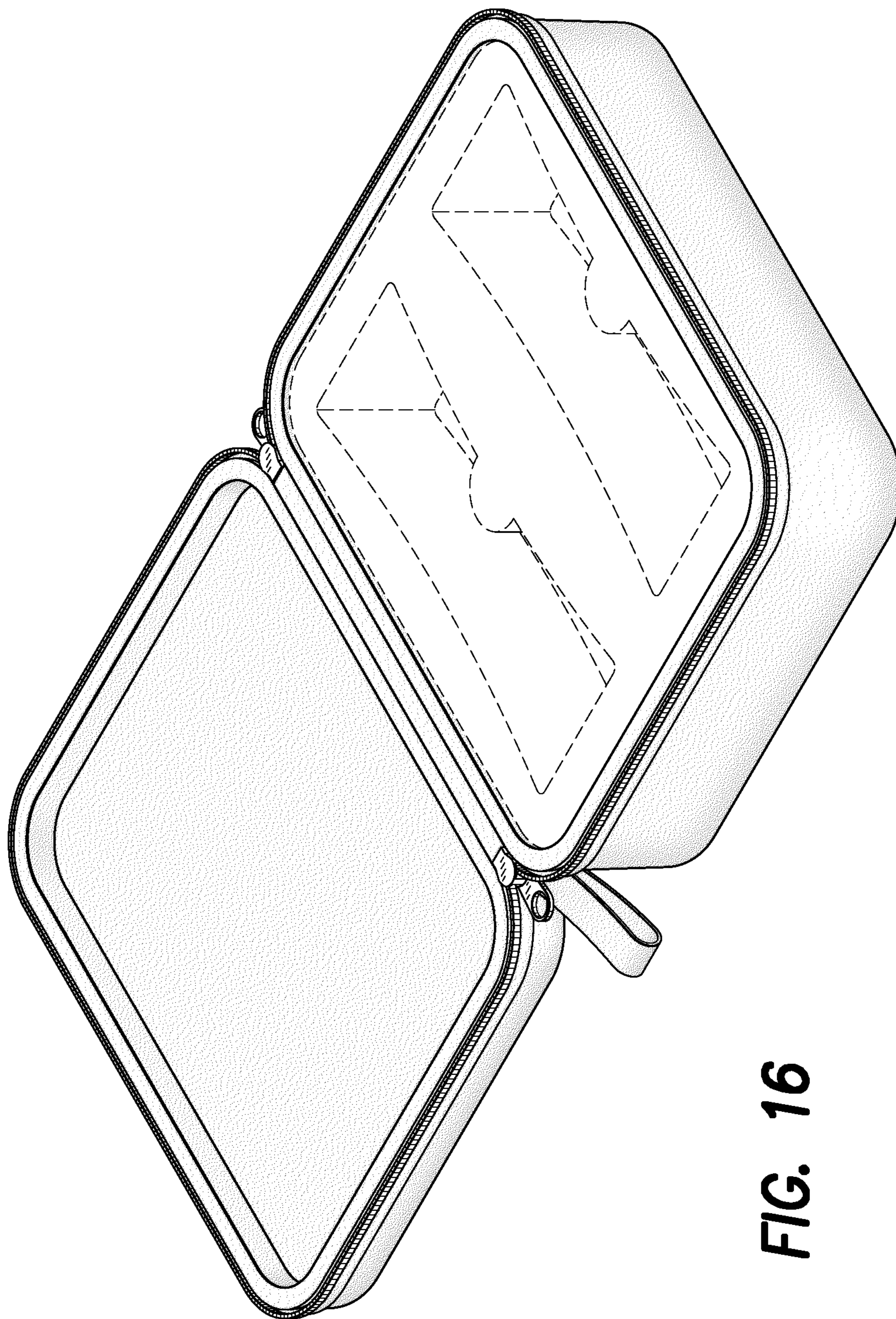

**FIG. 16**