



US00D685134S

(12) **United States Design Patent**
Santavicca

(10) **Patent No.:** **US D685,134 S**
(45) **Date of Patent:** **** Jun. 25, 2013**

(54) **LIP GLOSS DISPENSER**

(76) Inventor: **Nicole M. Santavicca**, Fairfax, VA (US)

(**) Term: **14 Years**

(21) Appl. No.: **29/404,659**

(22) Filed: **Oct. 24, 2011**

(51) **LOC (9) Cl.** **28-03**

(52) **U.S. Cl.**
USPC **D28/85; D9/729**

(58) **Field of Classification Search**
USPC 206/385, 823, 581; D28/76, 85-90,
D28/7; 132/317, 218; 401/68-79, 126-130,
401/202; D9/731, 729; D3/208
See application file for complete search history.

(56) **References Cited**

U.S. PATENT DOCUMENTS

2,039,323	A *	5/1936	Lessin	132/318
2,196,127	A *	4/1940	Stogran	401/19
2,653,339	A	9/1953	Mureau		
2,717,339	A *	9/1955	Brown	361/634
D262,768	S *	1/1982	Bovet	D28/85
5,067,836	A	11/1991	Khan		
D351,049	S *	9/1994	Schlueter	D28/77
D433,562	S *	11/2000	Redlinger	D3/208
D496,135	S *	9/2004	Hillock	D28/85

6,923,589	B2	8/2005	Blackwell		
D522,696	S *	6/2006	Severa	D28/88
D593,713	S *	6/2009	Fogelson	D28/85
2004/0031829	A1	2/2004	Guimond et al.		
2006/0131431	A1	6/2006	Finn		
2013/0025614	A1*	1/2013	Morgan	132/200

* cited by examiner

Primary Examiner — Jennifer Rivard

(57) **CLAIM**

The ornamental design for a lip gloss dispenser, as shown and described.

DESCRIPTION

FIG. 1 is a front elevation view of a lip gloss dispenser showing my new design showing a lid separated for clarity; FIG. 2 is a rear elevation view thereof; FIG. 3 is a right elevation view thereof; FIG. 4 is a left elevation view thereof; FIG. 5 is a top plan view thereof; FIG. 6 is a bottom plan view thereof; FIG. 7 is an isometric view thereof; and, FIG. 8 is a cross-sectional view thereof taken along line 8-8 of FIG. 7.

The broken lines in the drawings depict environmental subject matter only and form no part of the claimed design.

1 Claim, 5 Drawing Sheets

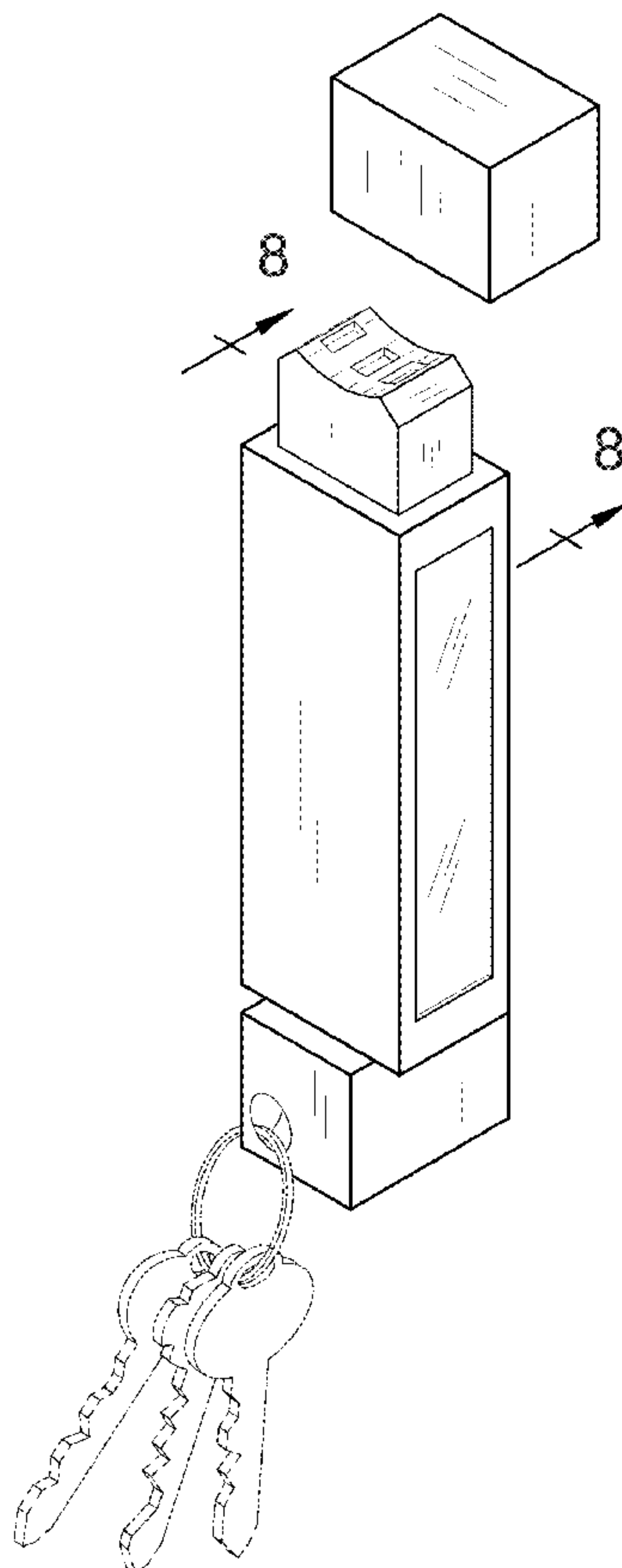

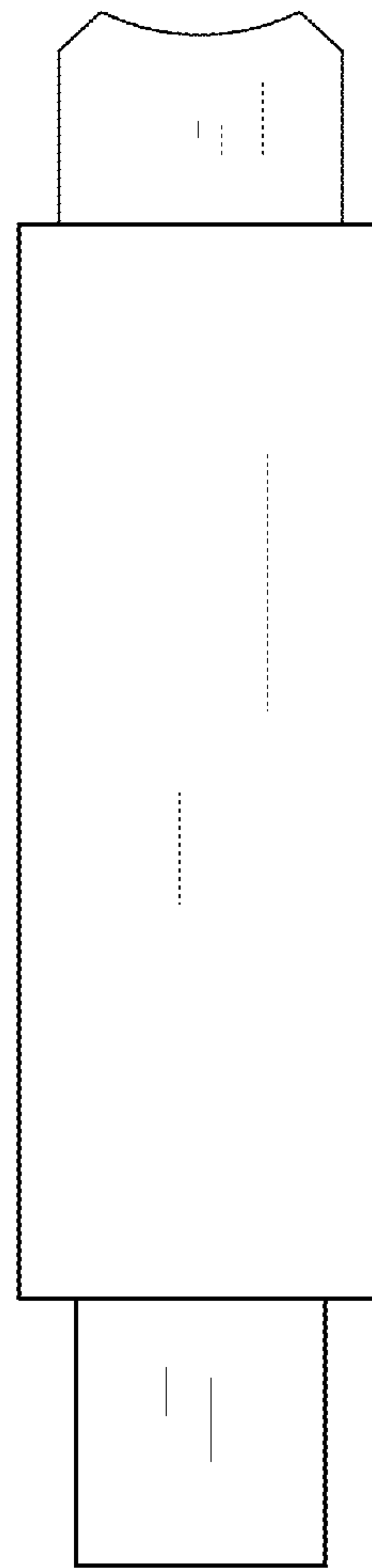
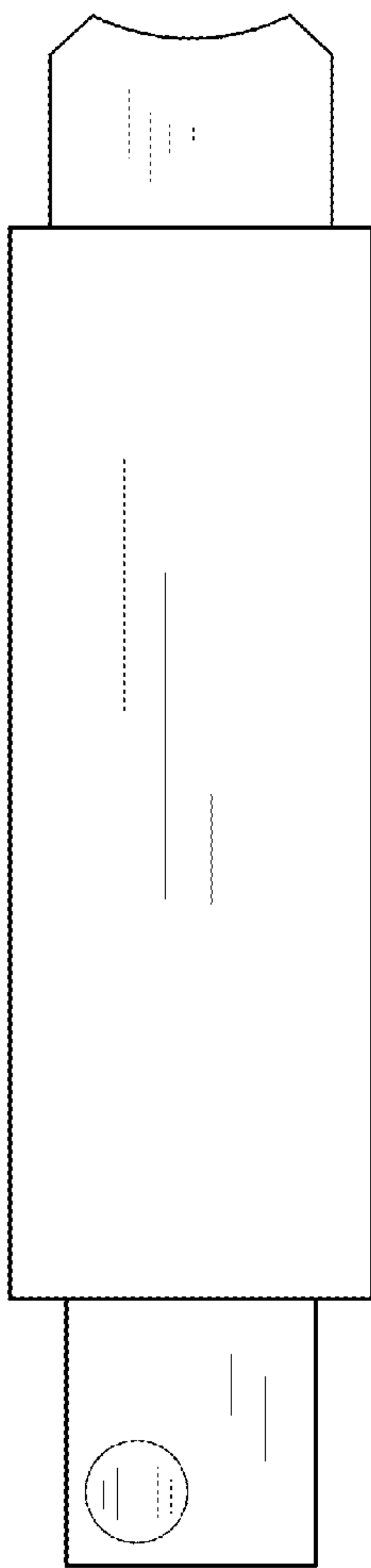
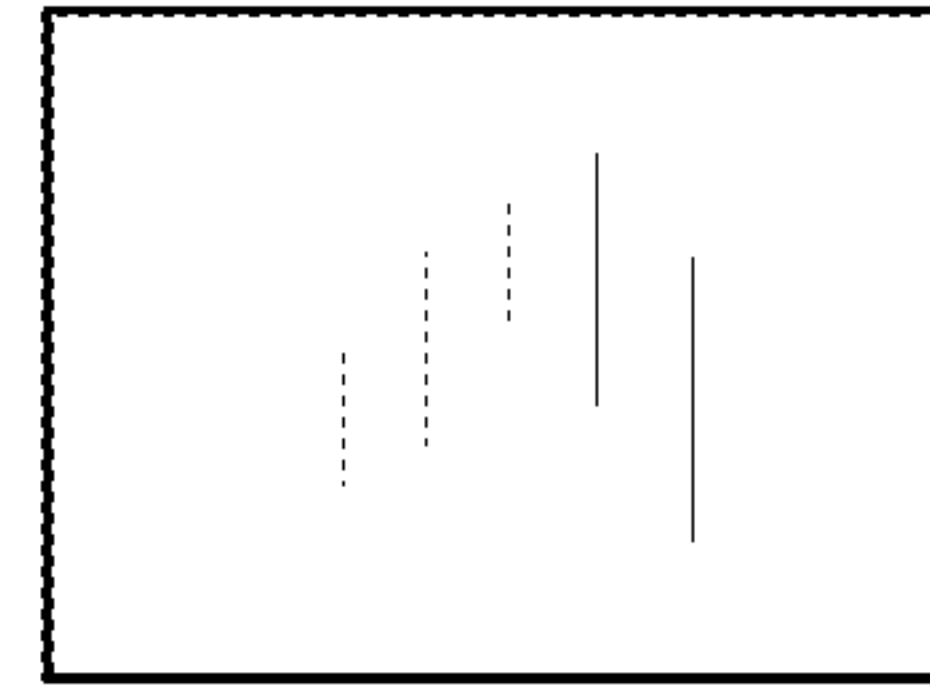
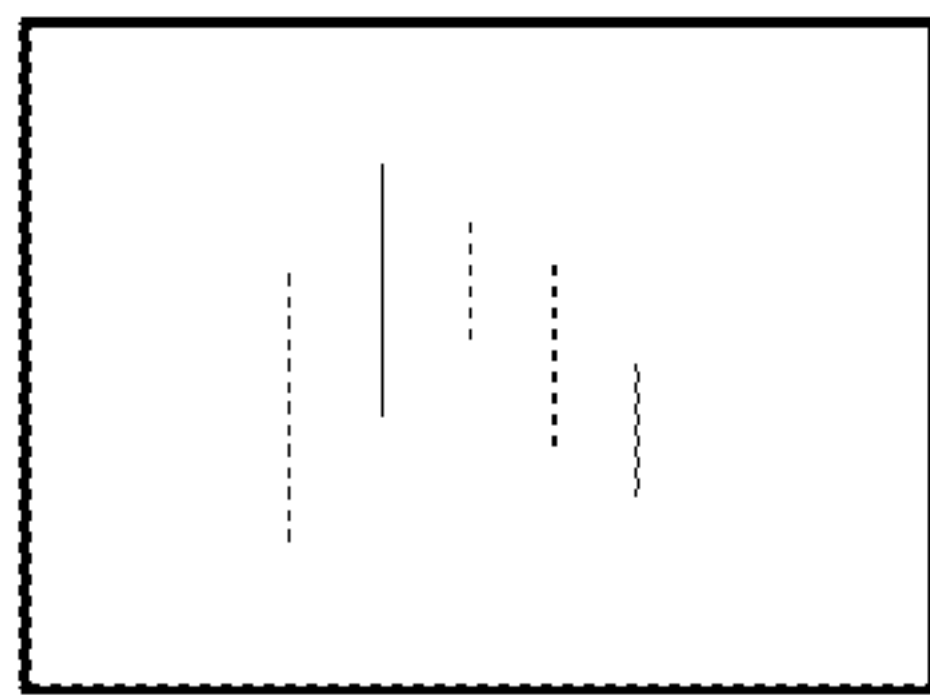

FIG. 1

FIG. 2

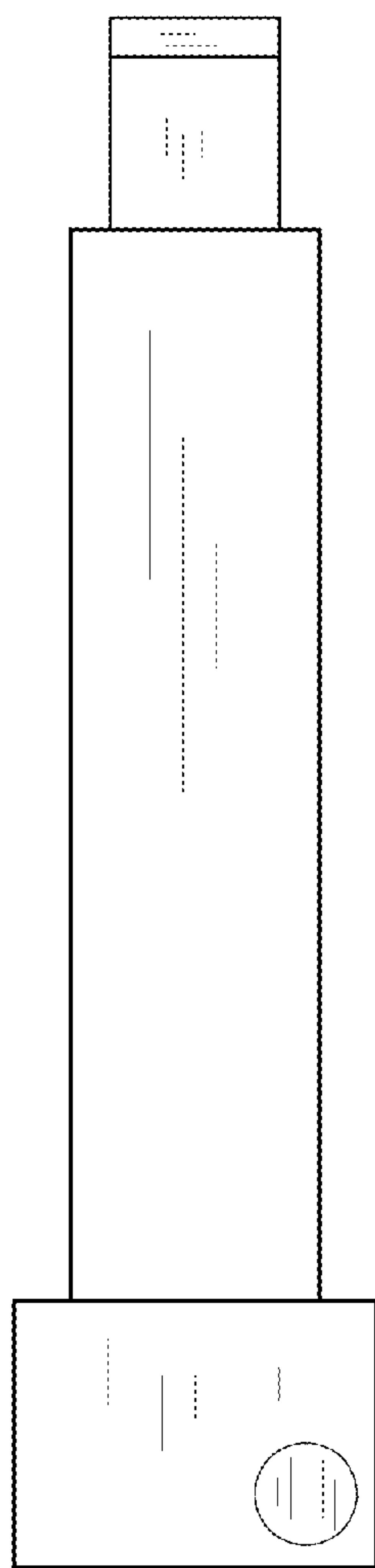
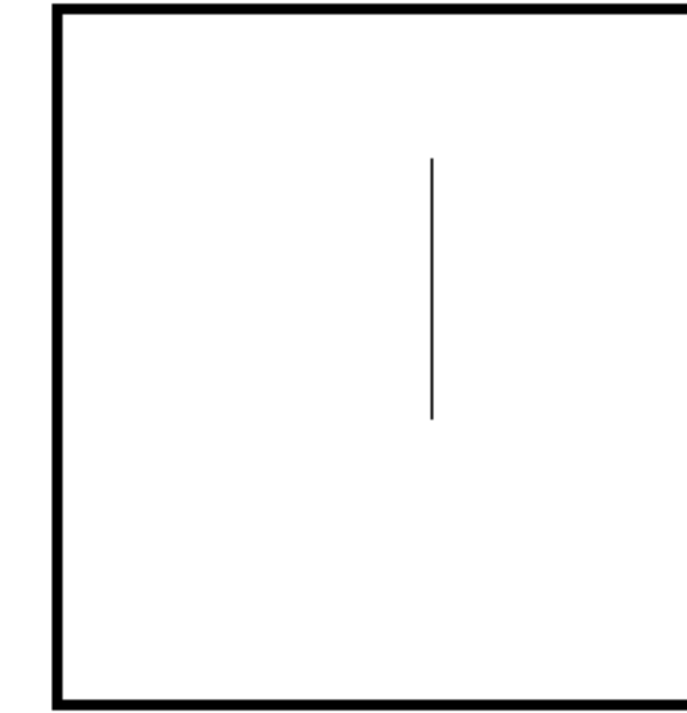
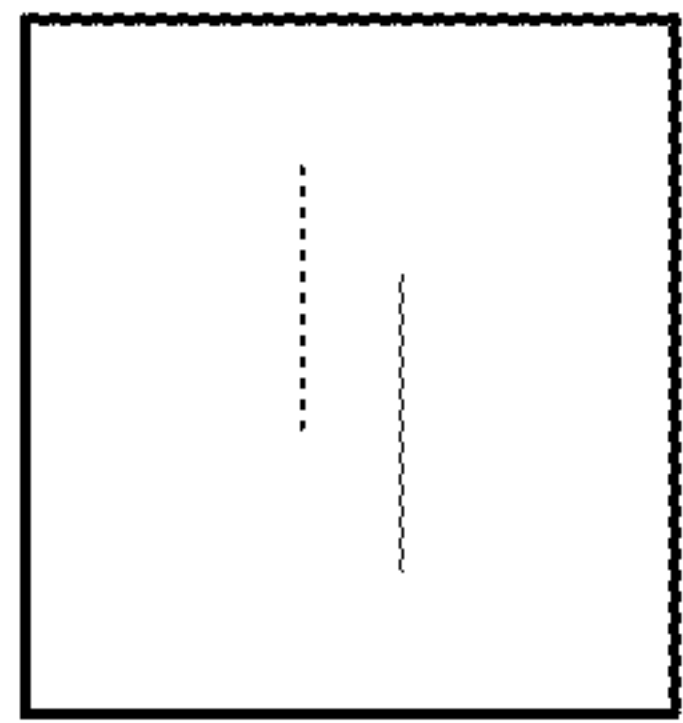

FIG. 3

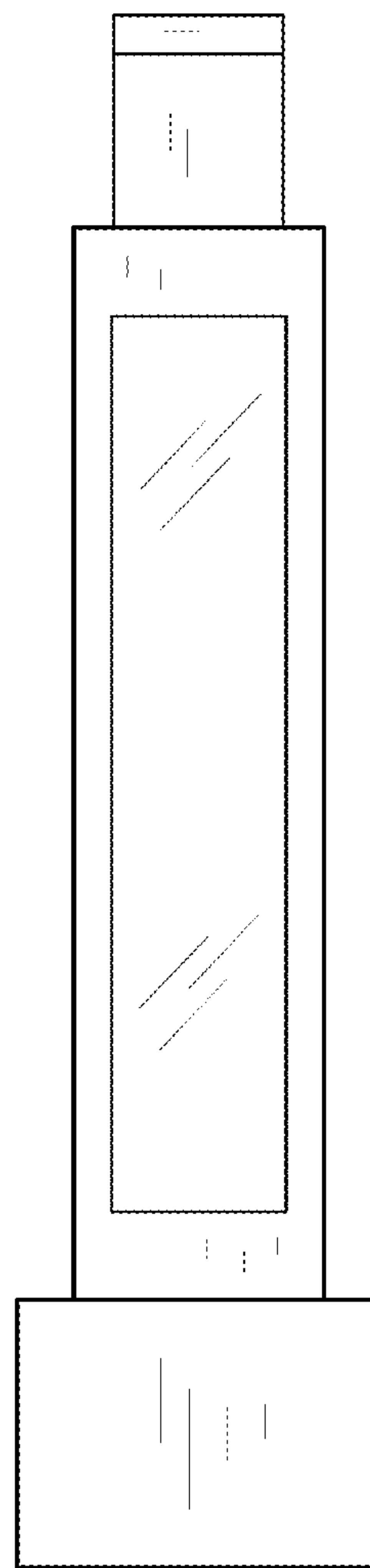

FIG. 4

FIG. 5

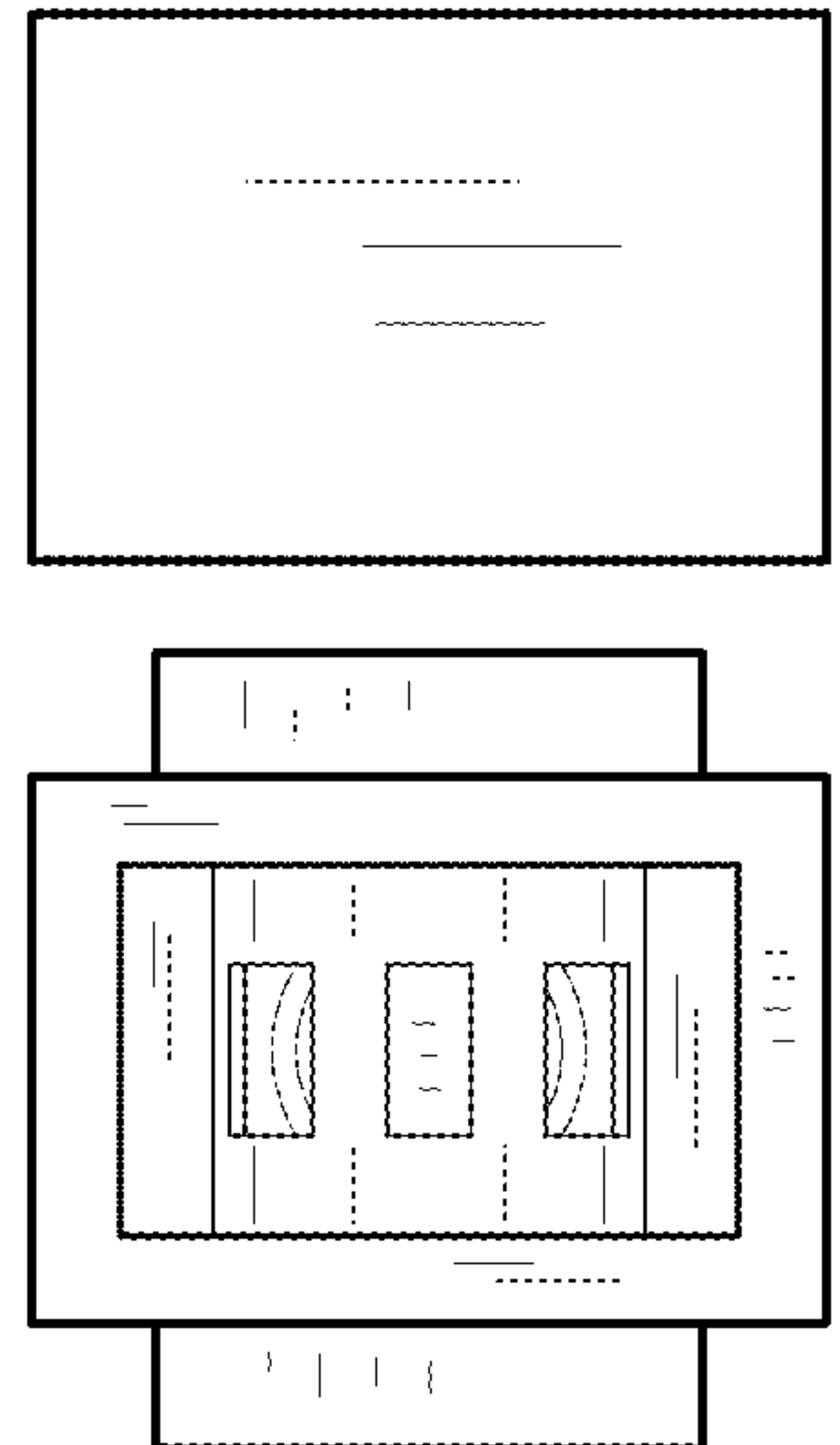
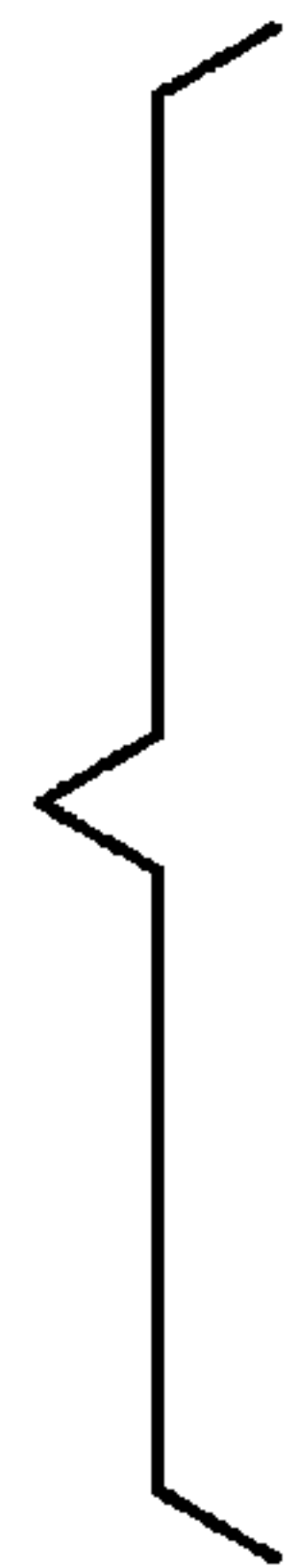
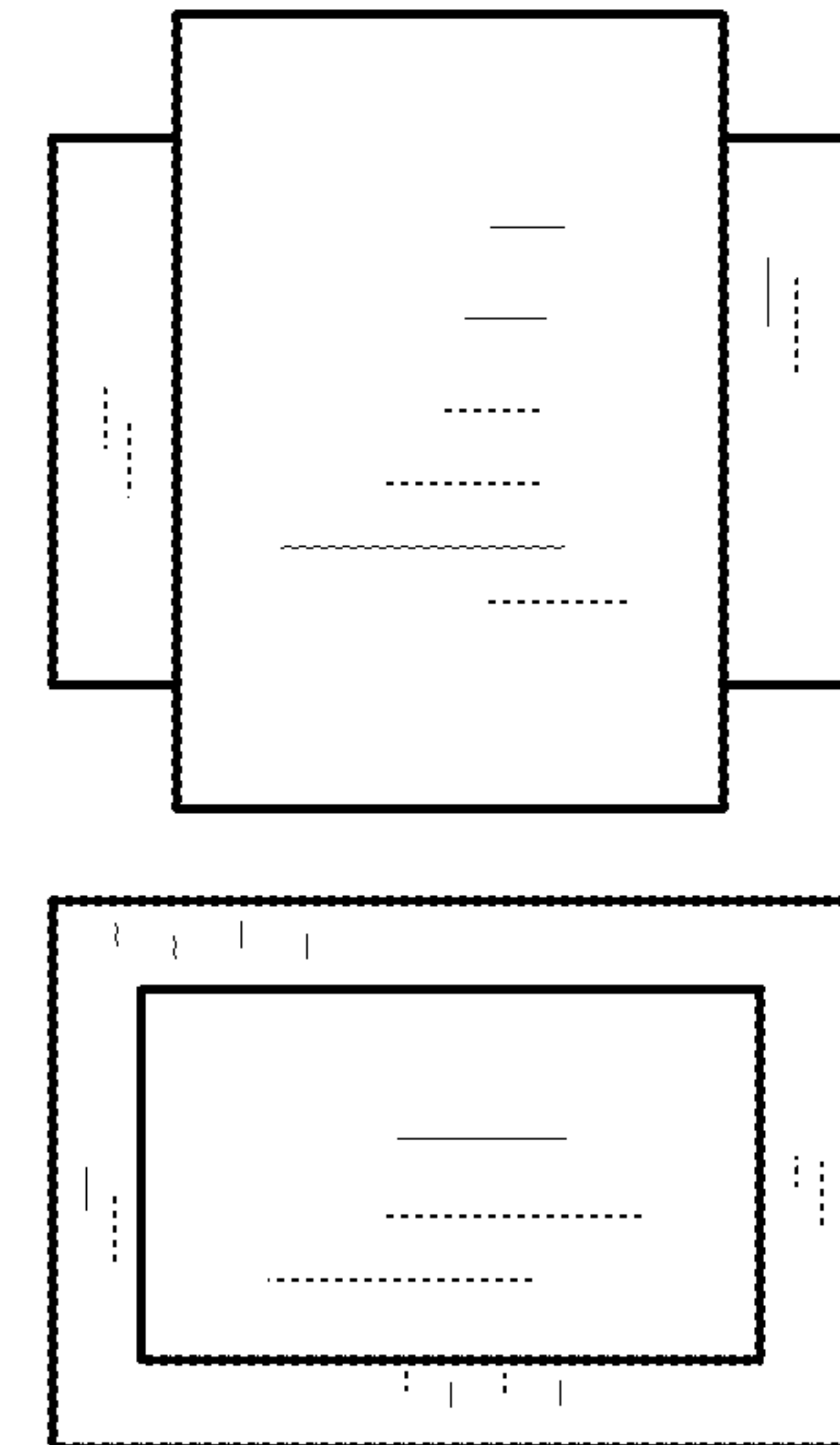
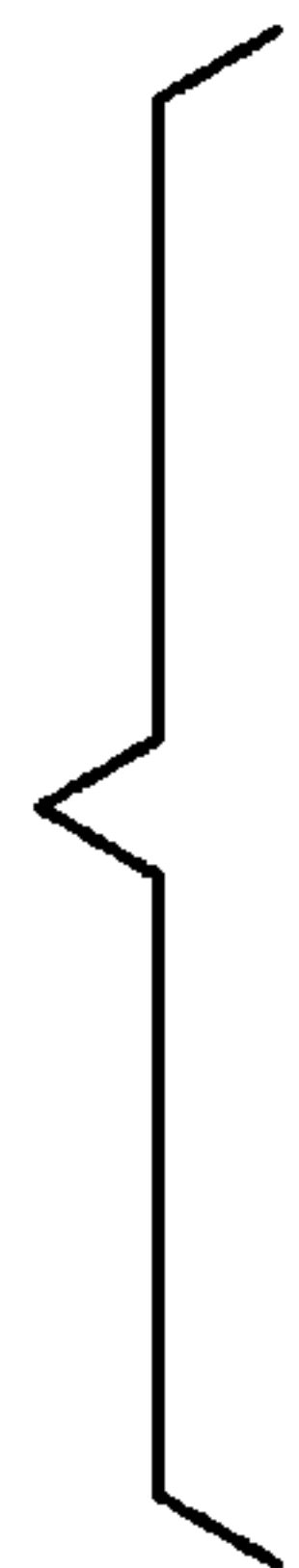
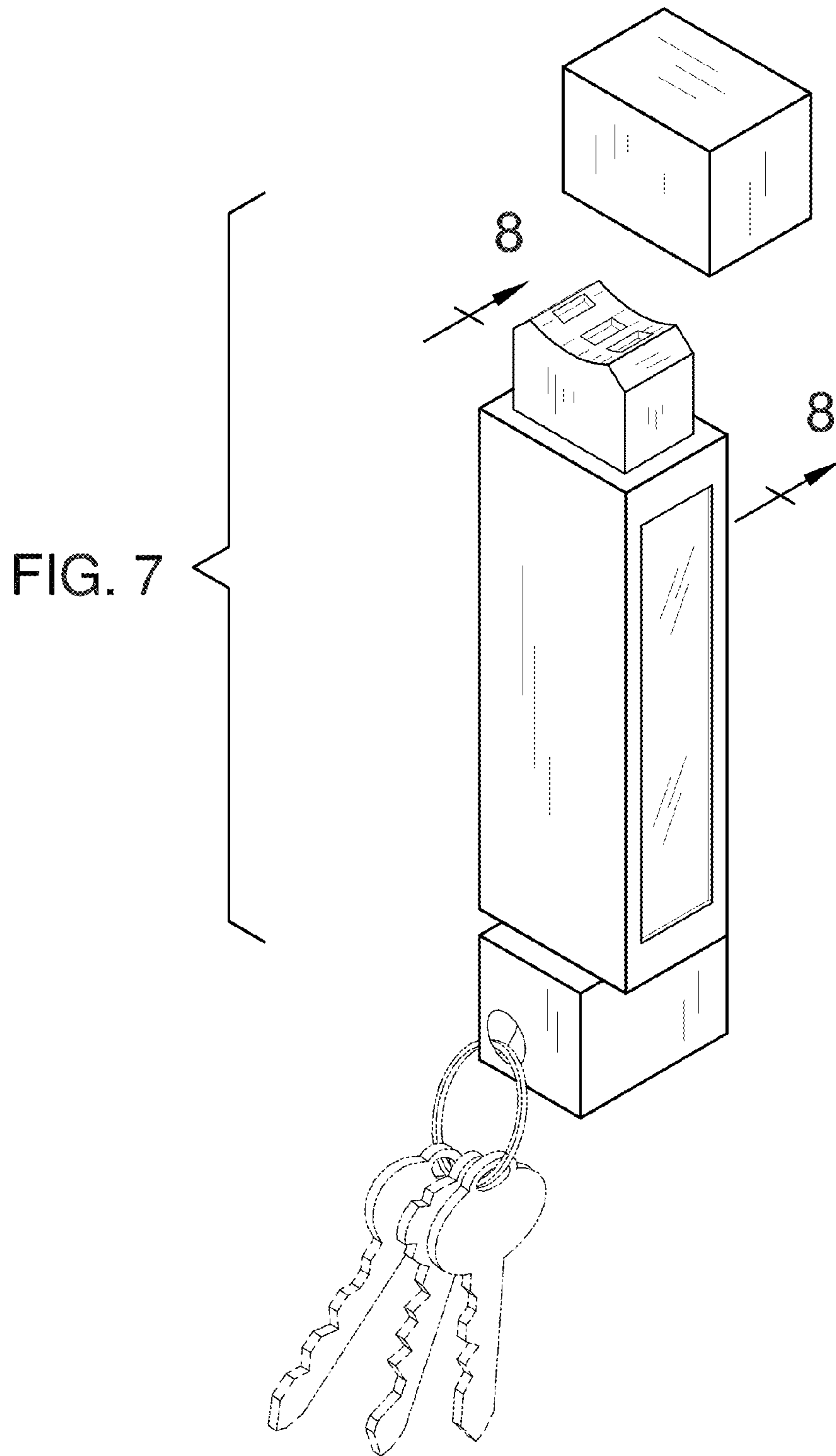

FIG. 6





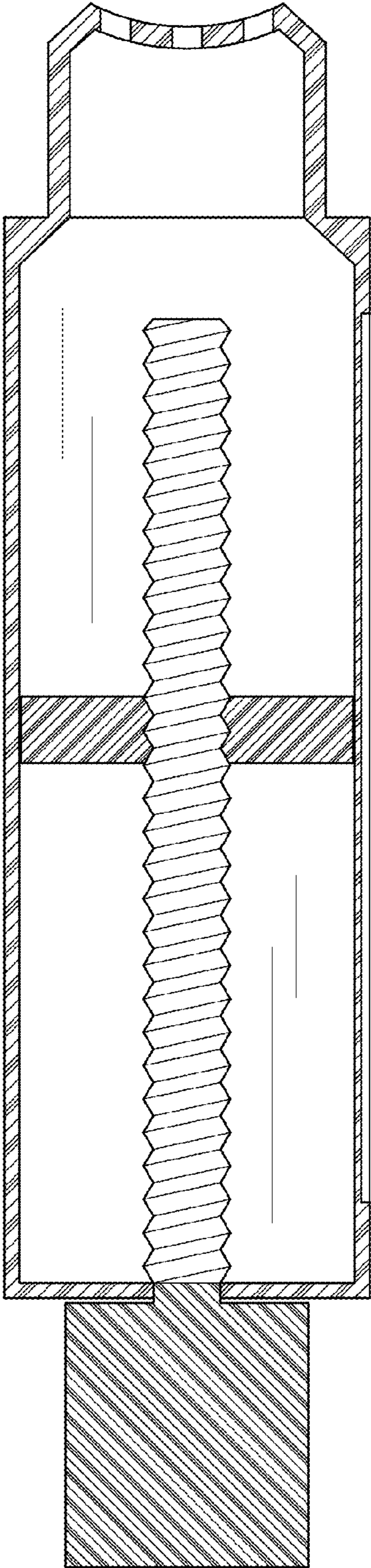

FIG. 8