



US00D685029S

(12) **United States Design Patent**
Cooper et al.

(10) **Patent No.:** **US D685,029 S**
(45) **Date of Patent:** **** Jun. 25, 2013**

(54) **CORRECTION TAPE DISPENSER**

(75) Inventors: **Jason J. Cooper**, Watertown, MA (US);
Jan Schminke, Marshfield, MA (US)

(73) Assignee: **Sanford, L.P.**, Oak Brook, IL (US)

(**) Term: **14 Years**

(21) Appl. No.: **29/380,804**

(22) Filed: **Dec. 10, 2010**

(51) **LOC (9) Cl.** **19-02**

(52) **U.S. Cl.**
USPC **D19/69**

(58) **Field of Classification Search**
USPC D19/70, 69, 36, 68, 67; 242/588.6,
242/588.2; 225/77, 6, 56, 39, 26, 25, 19,
225/11, 34; 206/411; 156/577, 527, 523
See application file for complete search history.

(56) **References Cited**

U.S. PATENT DOCUMENTS

D410,494 S	6/1999	Hoffmann	
D410,955 S	6/1999	Hoffmann	
D436,129 S *	1/2001	Fujihara	D19/53
D457,564 S	5/2002	Kimura	
6,453,969 B1 *	9/2002	Ferrara	156/577
D466,939 S *	12/2002	Lee	D19/69
D485,302 S *	1/2004	Bain	D19/69
D492,355 S *	6/2004	Suzuki	D19/69
D544,543 S *	6/2007	Ono	D19/69
D571,404 S *	6/2008	Tullney et al.	D19/69
D573,646 S	7/2008	Wolff et al.	
D579,499 S *	10/2008	Rushe et al.	D19/69
D607,055 S *	12/2009	Koreska	D19/69
D640,321 S *	6/2011	Kuronuma	D19/69
D640,322 S *	6/2011	Kouda	D19/69
D640,742 S *	6/2011	Booty, Jr.	D19/69
D647,139 S *	10/2011	Quah et al.	D19/69

OTHER PUBLICATIONS

Liquid Paper Dryline Comfort Grip correction tape dispenser. <URL:
<http://www.officeworld.com/Worlds-Biggest-Selection/PAP6624/08Q3/>>. Publicly available before Sep. 12, 2008.

(Continued)

Primary Examiner — Austin Murphy

(74) *Attorney, Agent, or Firm* — Marshall, Gerstein & Borun
LLP

(57) **CLAIM**

The ornamental design for a correction tape dispenser, as shown and described.

DESCRIPTION

FIG. 1 is a top perspective view showing our new design for a correction tape dispenser;
FIG. 2 is a right side view of the correction tape dispenser of FIG. 1;
FIG. 3 is a left side view of the correction tape dispenser of FIG. 1;
FIG. 4 is a front view of the correction tape dispenser of FIG. 1;
FIG. 5 is a rear view of the correction tape dispenser of FIG. 1;
FIG. 6 is a top plan view of the correction tape dispenser of FIG. 1; and,
FIG. 7 is bottom plan view of the correction tape dispenser of FIG. 1.
The broken lines shown in the drawings represent portions of the correction tape dispenser that form no part of the claimed design.

1 Claim, 3 Drawing Sheets

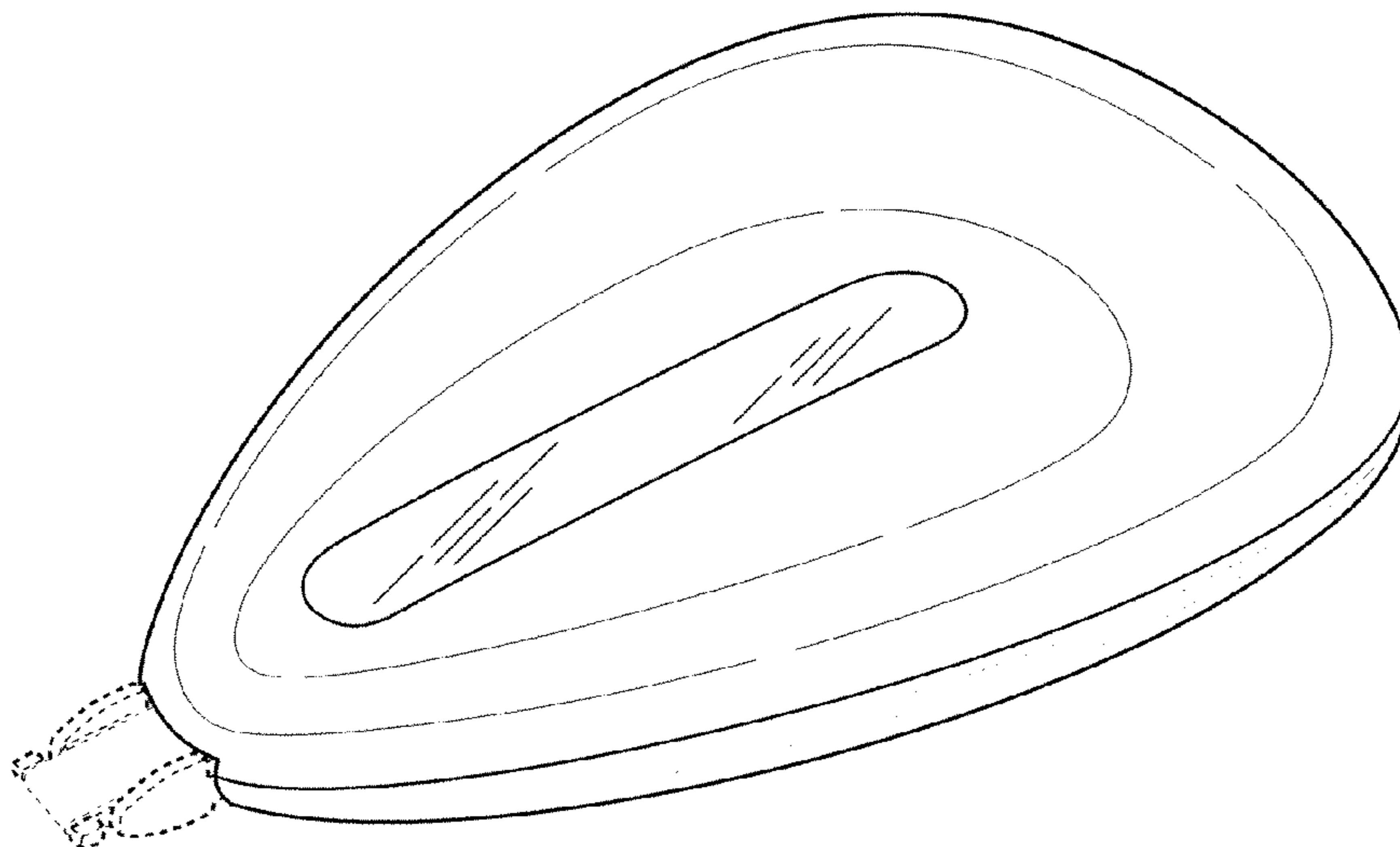

OTHER PUBLICATIONS

Sparco correction tape dispenser. Retrieved from the Internet: <URL: http://images.google.com/imgres?imgurl=http://s7.sears.com/is/image/Sears/09170846000%3Fhei%3D100%26wid%3D100%26op_sharpen%3D1&imgrefurl=http://www.kmart.com/shc/s/v_10151_10104_Computers%2B%26%2BElectronics%3Fsbf%3DBrand%26sbv%3DSparco&h=100&w=100&sz=2&hl=en&start=462&tbnid=pbvclSahKT13CM:&tbnh=82&tbnw=82&prev=/images%3Fq%3Dcorrection%2Btape%26start%3D460%26gbv%3D2%26ndsp%3D20%26hl%3Den%26sa%3DN>. Publicly available before Sep. 12, 2008.

Tipp-Ex Pckt Mouse correction tape dispenser. Retrieved from the Internet: <URL: http://www.eurwholesale.co.uk/_itemImages/med/835.jpg>. Publicly available before Sep. 12, 2008.

Correction tape dispenser. Retrieved from the Internet: <URL: http://commons.wikimedia.org/wiki/Image:Correction_tape_dispenser.jpg>. Publicly available before Sep. 12, 2008.

Mono wide width correction tape. Retrieved from the Internet: <URL: <http://www.tombowusa.com/OfficeIndex.aspx?category=C>>. Publicly available before Sep. 12, 2008.

Tombow Mono correction film. Retrieved from the Internet: <URL: <http://www.tombowusa.com/OfficeIndex.aspx?category=C>>. Publicly available before Sep. 12, 2008.

Ningbo Haishu Wenhua Stationery Factory correction tape dispenser. Retrieved from the Internet: <URL: http://www.lakewoodconferences.com/direct/dbimage/50098546/Correction_Tapes_Glue_Tapes.jpg>. Publicly available before Sep. 12, 2008.

Ninghai Pacific Network Science & Technology Co. correction tape. Retrieved from the Internet: <URL: <http://www.qbc.cn/main/exec/more/mod/pdts/pid/1909e4e6d0d5w2y4>>. Publicly available before Sep. 12, 2008.

Twingo correction tape. Retrieved from the Internet: <URL: http://images.google.com/imgres?imgurl=http://www.germes-online.com/direct/dbimage/50024521/Correction_Tape.jpg&imgrefurl=http://www.germes-online.com/catalog/51/1076/29/sell_stencil_duplicator.html&h=360&w=360&sz=20&hl=en&start=7&tbnid=r91iWDiGlx7XHM:&tbnh=121&tbnw=121&prev=/images%3Fq%3Dcorrection%2Btape%26gbv%3D2%26hl%3Den>. Publicly available before Sep. 12, 2008.

Tombow Mono correction tape metro colored dispensers. Retrieved from the Internet: <URL: <http://office.pricegrabber.com/erasers-correction-tape-fluid/m/904873171>>. Publicly available before Sep. 12, 2008.

Tombow Mono correction mega tape. Retrieved from the Internet: <URL: <http://www.tombowusa.com/OfficeIndex.aspx?category=C>>. Publicly available before Sep. 12, 2008.

Bic Wite-Out correction tape. Retrieved from the Internet: <URL: <http://www.wite-out.com/tapes/>>. Publicly available before Sep. 12, 2008.

Mantis correction tape. Retrieved from the Internet: <URL: <http://www.senatorpen.com/ParentDetail.aspx?ID=65>>. Publicly available before Sep. 12, 2008.

Quill Brand correction tape. Retrieved from the Internet: <URL: http://images.google.com/imgres?imgurl=http://www01.quillcorp.com/images/products/catalog/products_LG/99404_std2.jpg&imgrefurl=http://www01.quillcorp.com/includes/web_track.asp%3Fweb_track_id%3D60080161%26position_id%3D3%26pro_mo_code%3D99999%26dest_url%3D/catalog/browse/sku.asp%3FSKU%3D150685%2526PageType%3D1&h=180&w=180&sz=5&hl=en&start=279&tbnid=NeHSR0IUoQEO8M:&tbnh=101&tbnw=101&prev=/images%3Fq%3Dcorrection%2Btape%26start%3D260%26gbv%3D2%26ndsp%3D20%26hl%3Den%26sa%3DN>. Publicly available before Sep. 12, 2008.

Foray Jumbo correction tape. Retrieved from the Internet: <URL: http://images.google.com/imgres?imgurl=http://cdn.www.office depot.com/pictures/SK/MD/729912_sk_md.jpg&imgrefurl=http://www.officedepot.com/a/products/729912/Jumbo-Correction-Tape-1-Line-x/&h=150&w=150&sz=6&hl=en&start=289&tbnid=TFtj7Ui9b6UJrM:&tbnh=96&tbnw=96&prev=/images%3Fq%3Dcorrection%2Btape%26start%3D280%26gbv%3D2%26ndsp%3D20%26hl%3Den%26sa%3DN>. Publicly available before Sep. 12, 2008.

Correction tape. Retrieved from the Internet: <URL: <http://www.rapidonline.com/netalogue/zoomed/Large/06101601.jpg>>. Publicly available before Sep. 12, 2008.

Mause dry correction tape. Retrieved from the Internet: <URL: http://www.viettranvn.com/htmls/correction_tape.php>. Publicly available before Sep. 12, 2008.

Pritt Correct-it-compact white dry tape correction roller. Retrieved from the Internet: <URL: <http://www.discountofficeproducts.co.uk/pritt-correct-it-compact-white-dry-tape-correction-roller-84mm-pr-1033896.html?xid=d039605d184944e057941784a66a55c0>>. Publicly available before Sep. 12, 2008.

TESA correction rollers. Retrieved from the Internet: <URL: <http://www.mayfairstationers.co.uk/tesa-correction-rollers-p-8003.html>>. Publicly available before Sep. 12, 2008.

* cited by examiner

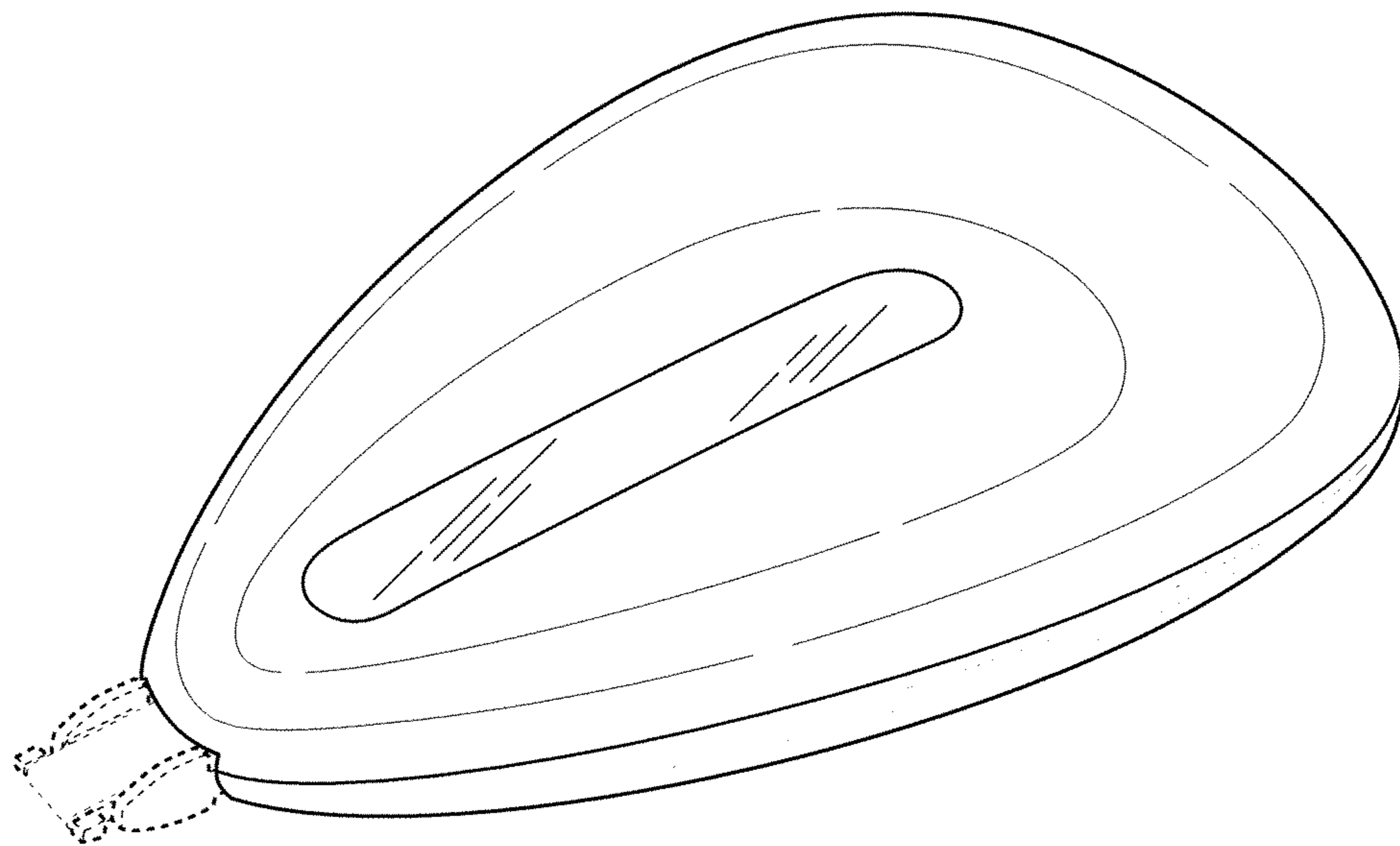

FIG. 1

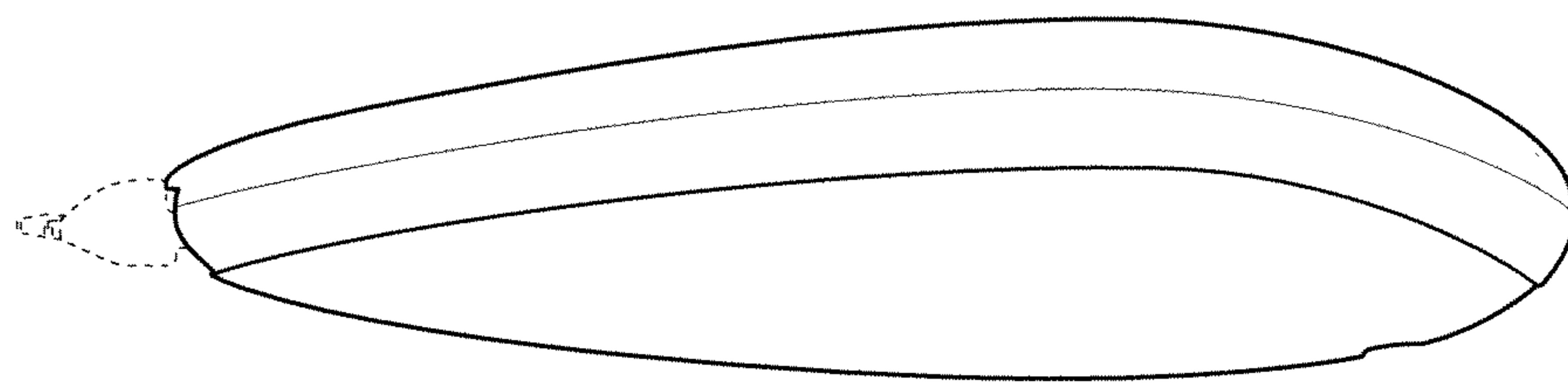

FIG. 2

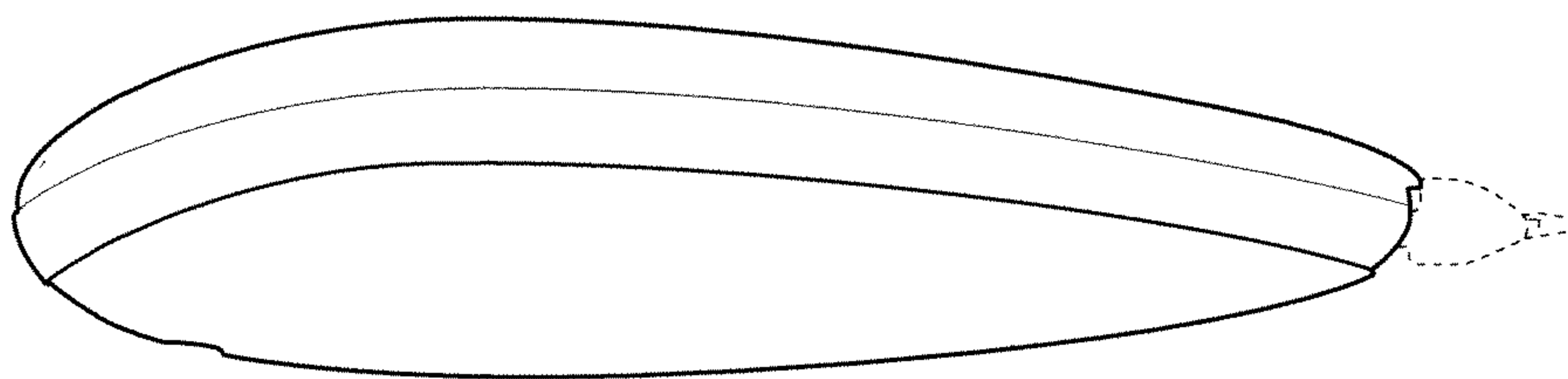

FIG. 3

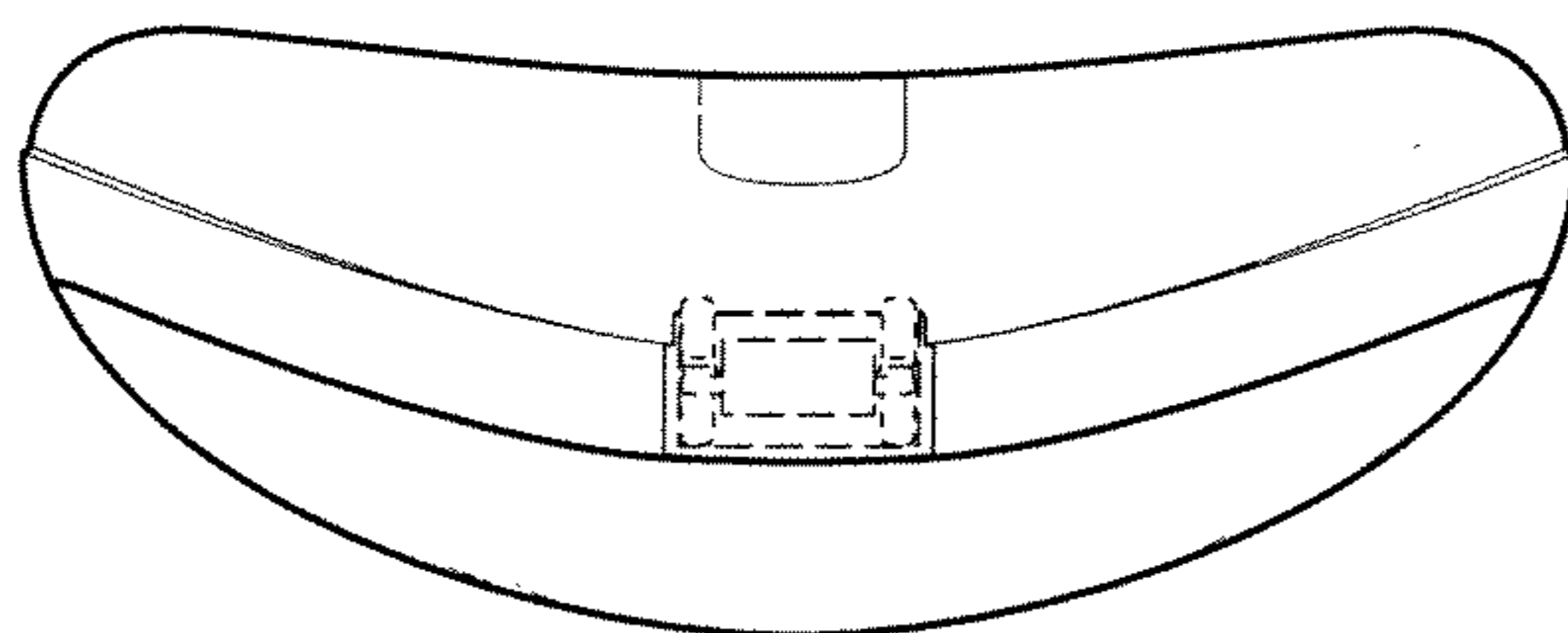

FIG. 4

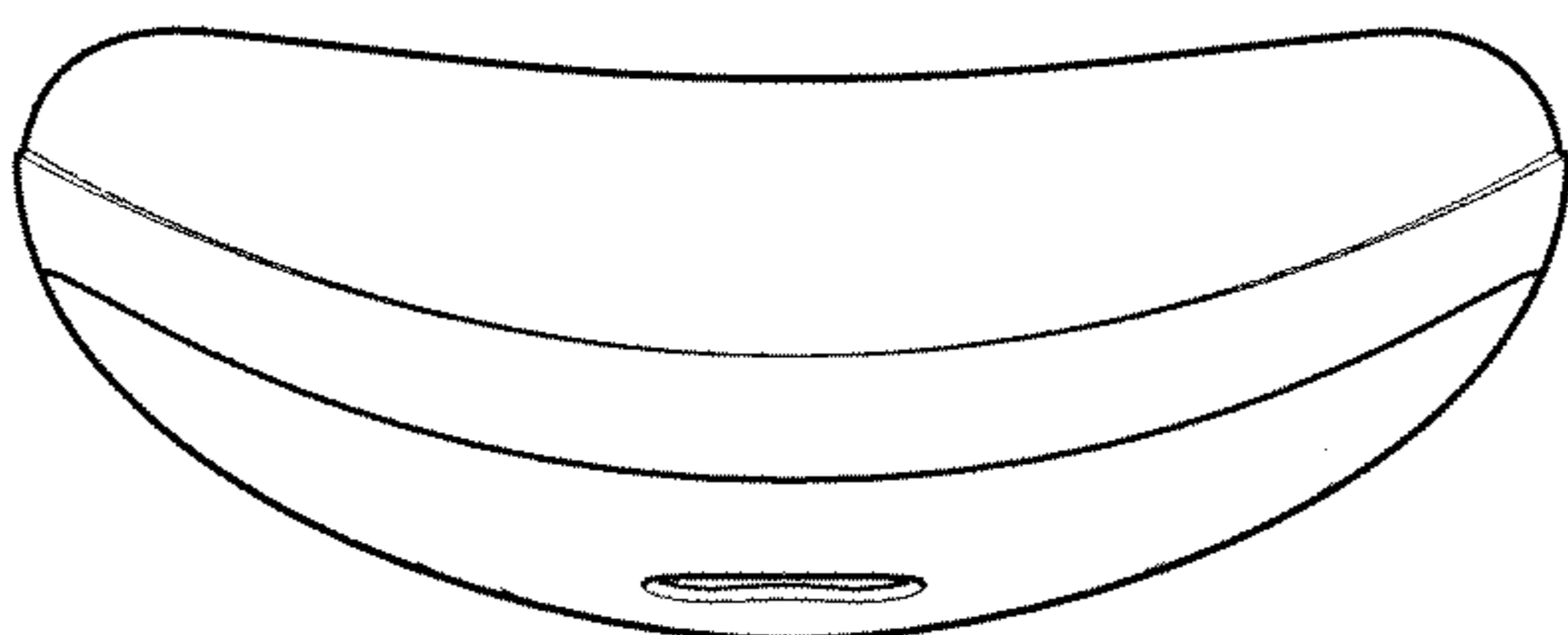

FIG. 5

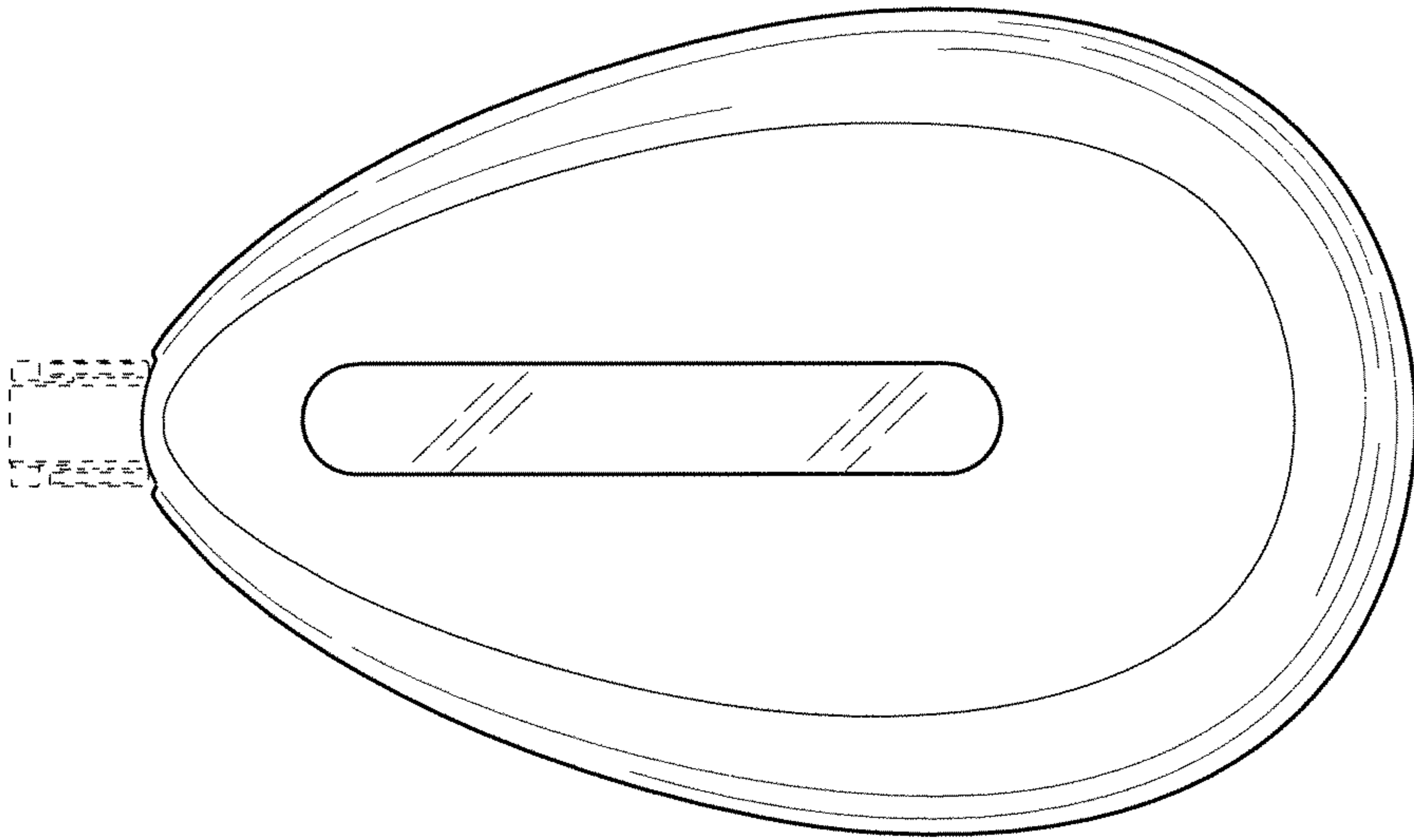

FIG. 6

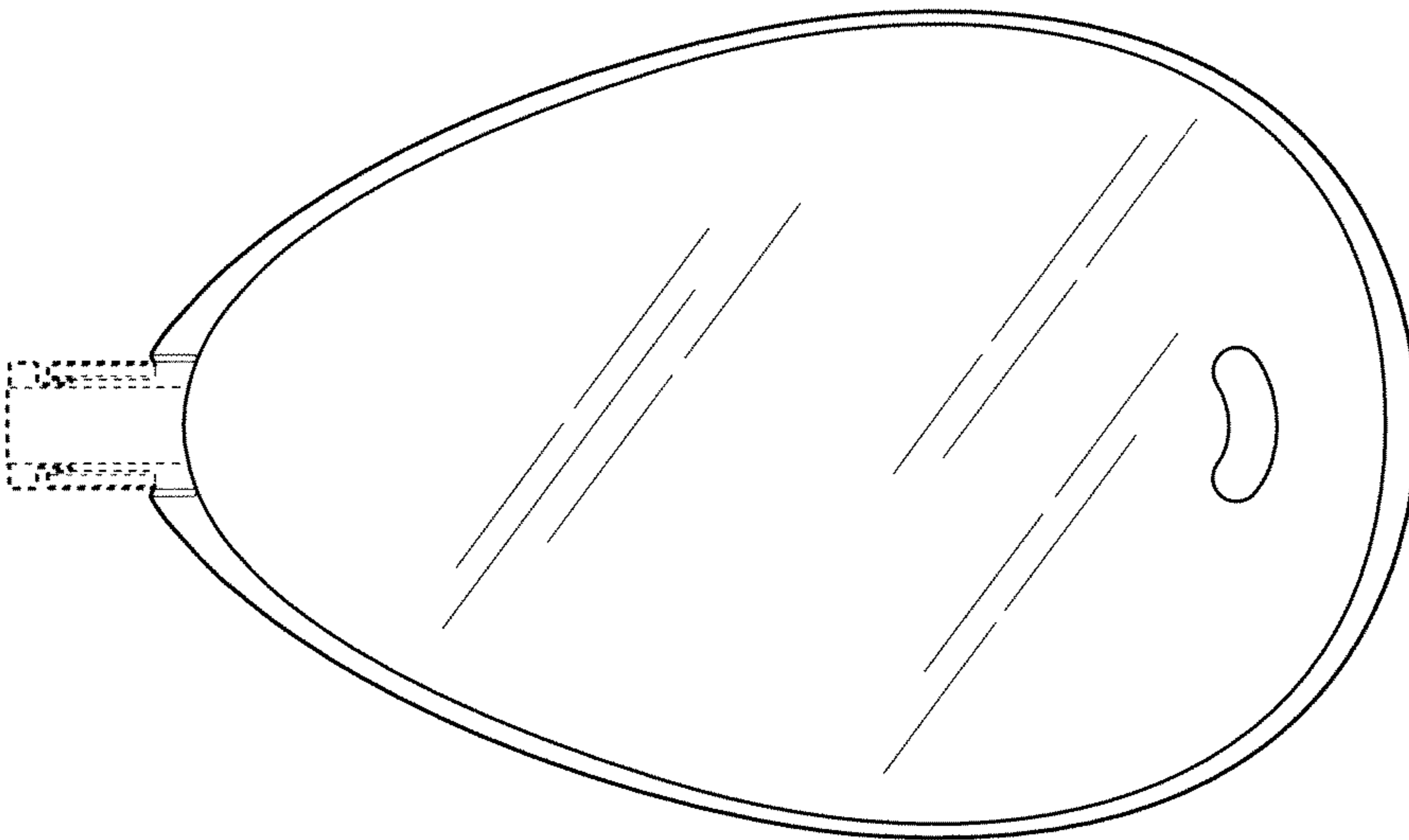

FIG. 7