



US00D684970S

(12) **United States Design Patent**
Zhang

(10) **Patent No.:** **US D684,970 S**
(45) **Date of Patent:** **** Jun. 25, 2013**

(54) **TABLET**

(75) Inventor: **Ke Zhang**, Hai Dian District (CN)

(73) Assignee: **Thomson Licensing**,
Issy-les-Moulineaux Cedex (FR)

(**) Term: **14 Years**

(21) Appl. No.: **29/426,399**

(22) Filed: **Jul. 5, 2012**

Related U.S. Application Data

(62) Division of application No. 29/388,517, filed on Mar. 30, 2011.

(51) **LOC (9) Cl.** **14-02**

(52) **U.S. Cl.**
USPC **D14/341**

(58) **Field of Classification Search**
USPC D14/341-347, 137, 138, 138.1, 138 A,
D14/138 AA, 138 R, 138 AB, 138 AC, 138 AD,
D14/138 C, 138 G, 496, 203.1, 203.3, 203.4,
D14/203.5, 203.7, 426, 427, 432, 429, 129,
D14/130, 420, 439-441, 448, 125, 126, 147,
D14/156, 218, 247-248, 250, 389, 388,
315-318; D10/65, 104; D18/6-7; D21/324,
D21/329, 330; D19/26, 59, 60; 455/556.1,
455/556.2, 566, 575.1, 90.3; 379/433.04,
379/433.01, 433.06, 916; 345/169, 173, 901,
345/905; 361/679.26, 679.27, 679.3, 679.55,
361/679.56

See application file for complete search history.

(56) **References Cited**

U.S. PATENT DOCUMENTS

D321,172	S	*	10/1991	Moore et al.	D14/389
D497,362	S	*	10/2004	Wang et al.	D14/371
D515,082	S	*	2/2006	Moskaluk et al.	D14/341
D582,875	S	*	12/2008	Haspil et al.	D14/138 G
D585,399	S	*	1/2009	Hwang	D14/130
D592,214	S	*	5/2009	Bradford	D14/371
D613,510	S	*	4/2010	Tzeng et al.	D6/308
D615,527	S	*	5/2010	Hwang	D14/203.8
D629,771	S	*	12/2010	Haspil et al.	D14/138 G
D635,535	S	*	4/2011	Cho et al.	D14/125
D639,267	S	*	6/2011	DeLorenzo et al.	D14/142
D640,654	S	*	6/2011	Montag et al.	D14/129
D641,749	S	*	7/2011	Leung et al.	D14/336
8,089,760	B2	*	1/2012	Yi-Chang	361/679.59
D653,661	S	*	2/2012	Ohrstrom	D14/341
D654,498	S	*	2/2012	Hwang et al.	D14/341
2006/0109617	A1	*	5/2006	Chen et al.	361/683

* cited by examiner

Primary Examiner — Barbara Fox

(74) *Attorney, Agent, or Firm* — Tutunjian & Bitetto, P.C.

(57) **CLAIM**

The ornamental design for a tablet, as shown and described.

DESCRIPTION

FIG. 1 is a front view of the tablet with a stand, according to my new design;
FIG. 2 is front perspective view thereof;
FIG. 3 is a back view thereof;
FIG. 4 is a rear perspective view thereof;
FIG. 5 is a right side view thereof; and,
FIG. 6 is a right side view thereof with the stand extended.
The broken lines shown in the drawings represent portions of the tablet that form no part of the claimed design.

1 Claim, 3 Drawing Sheets

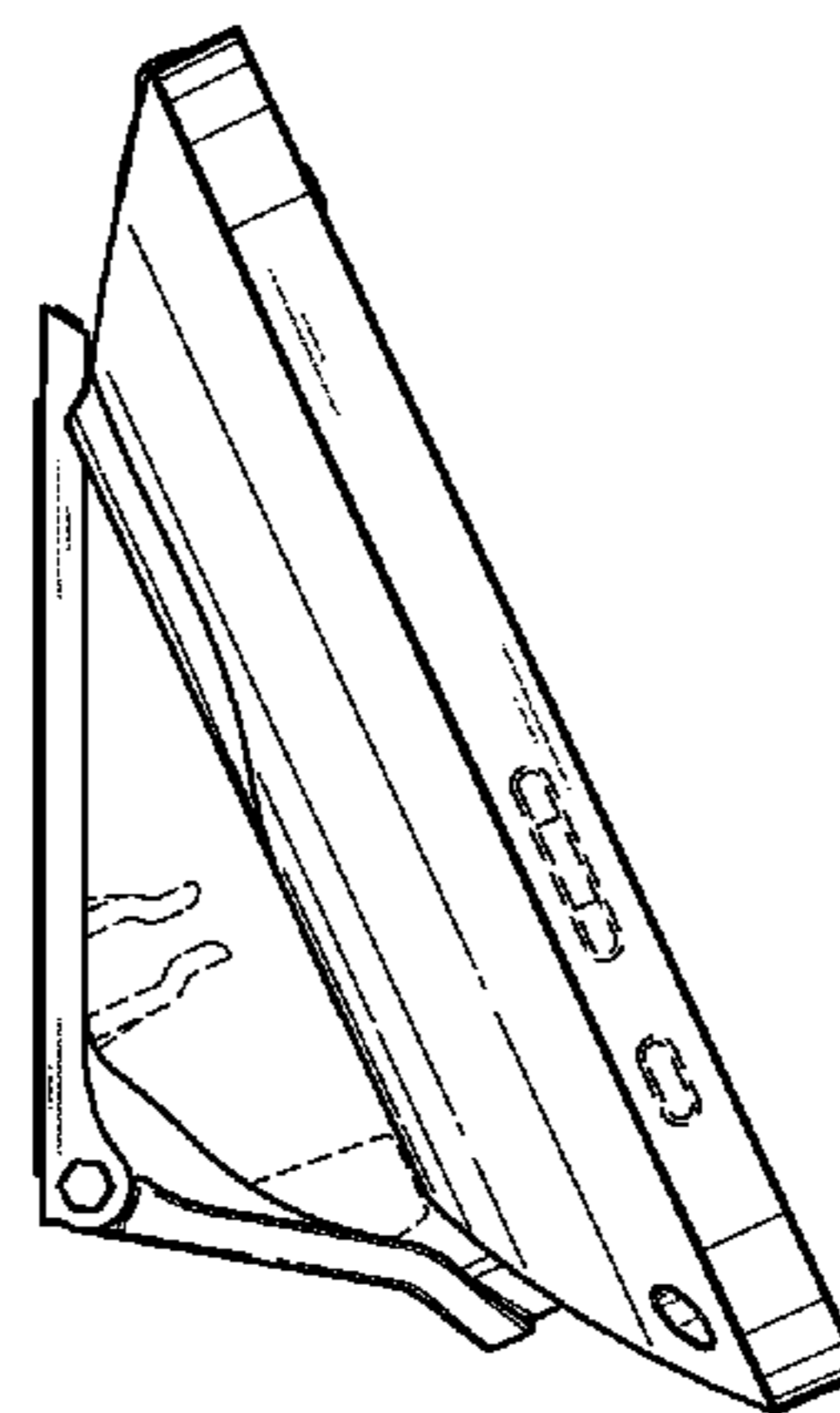
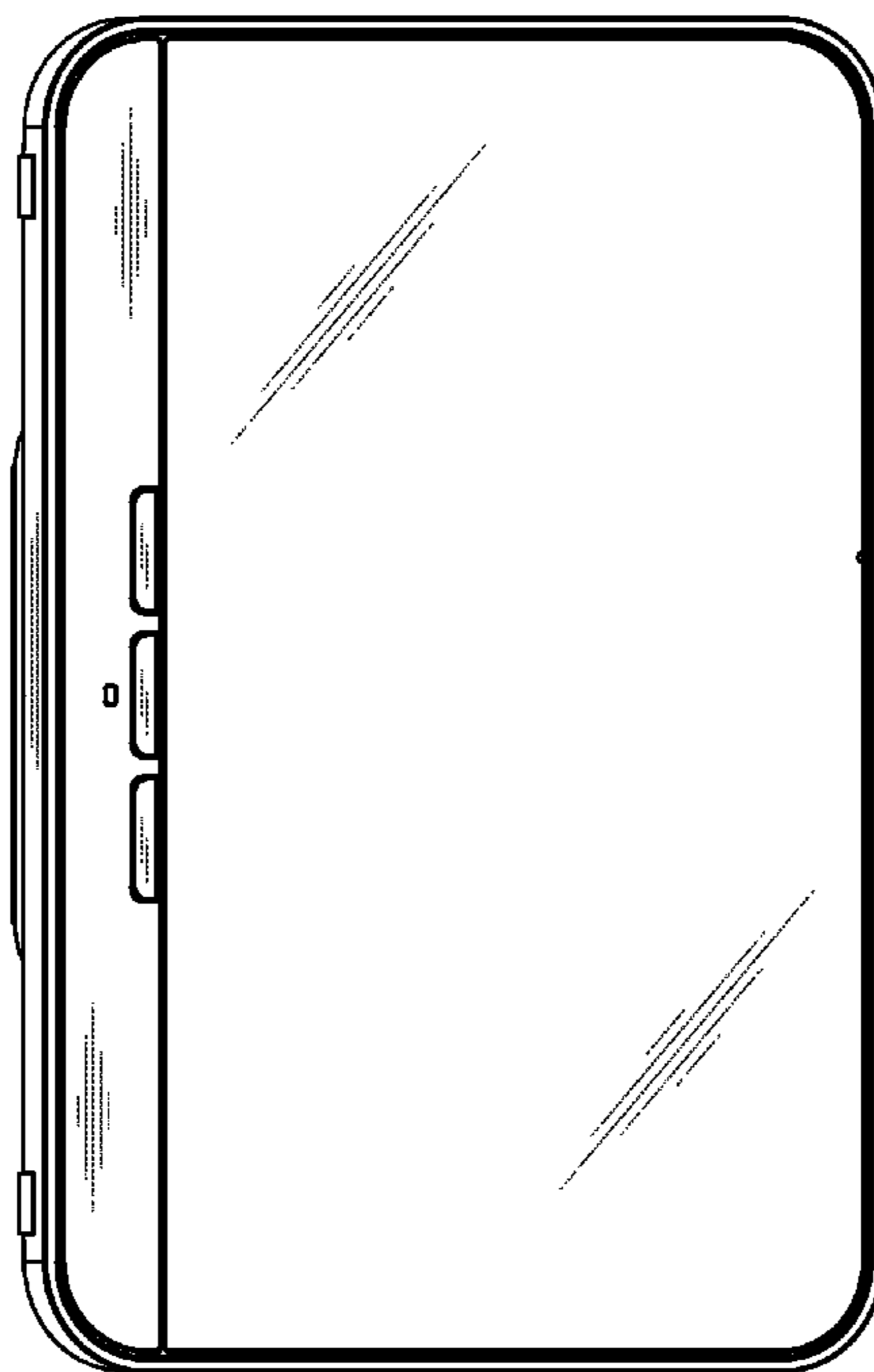

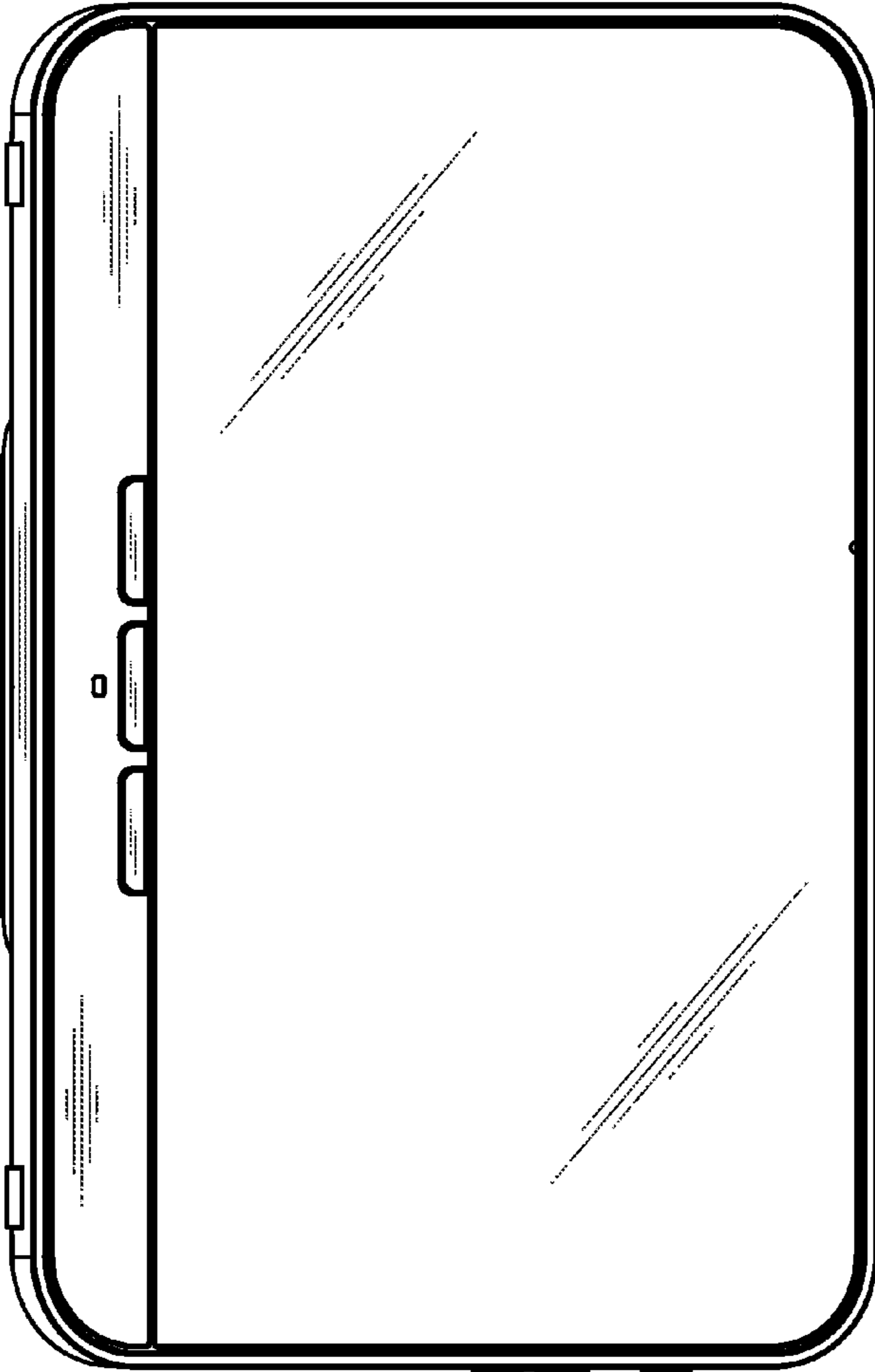

FIG. 1

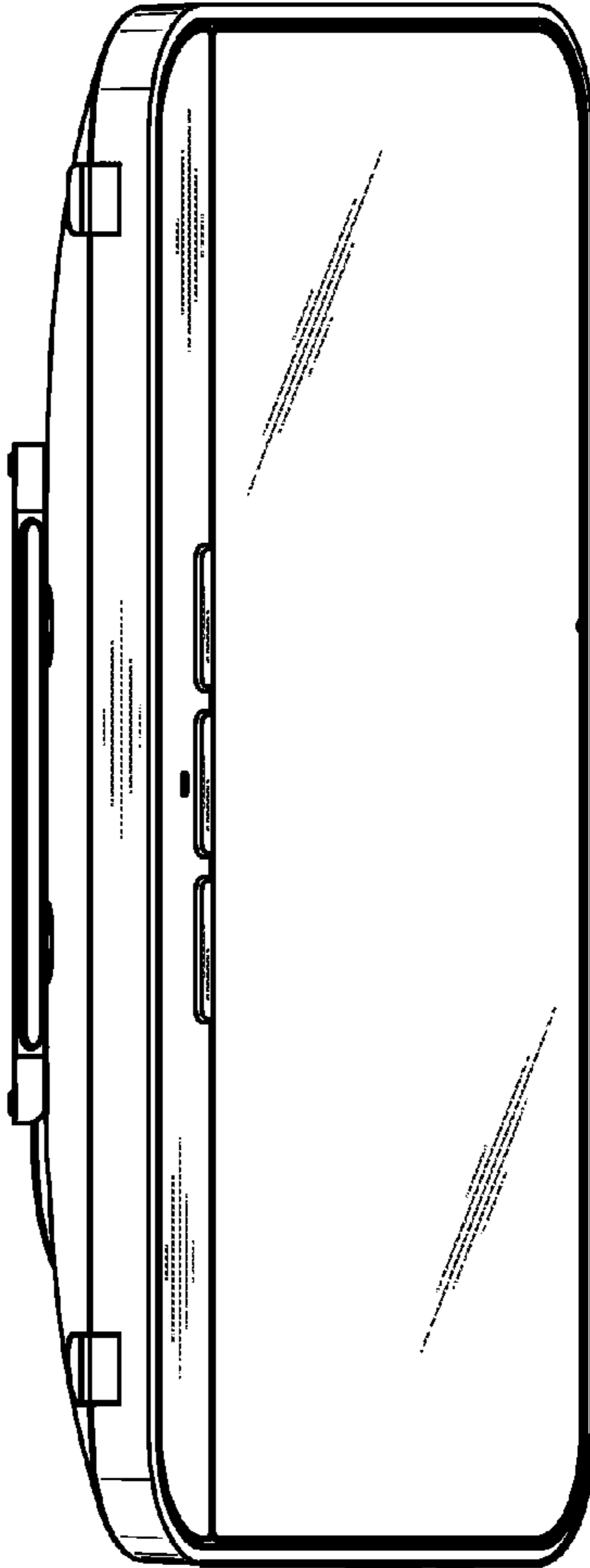

FIG. 2

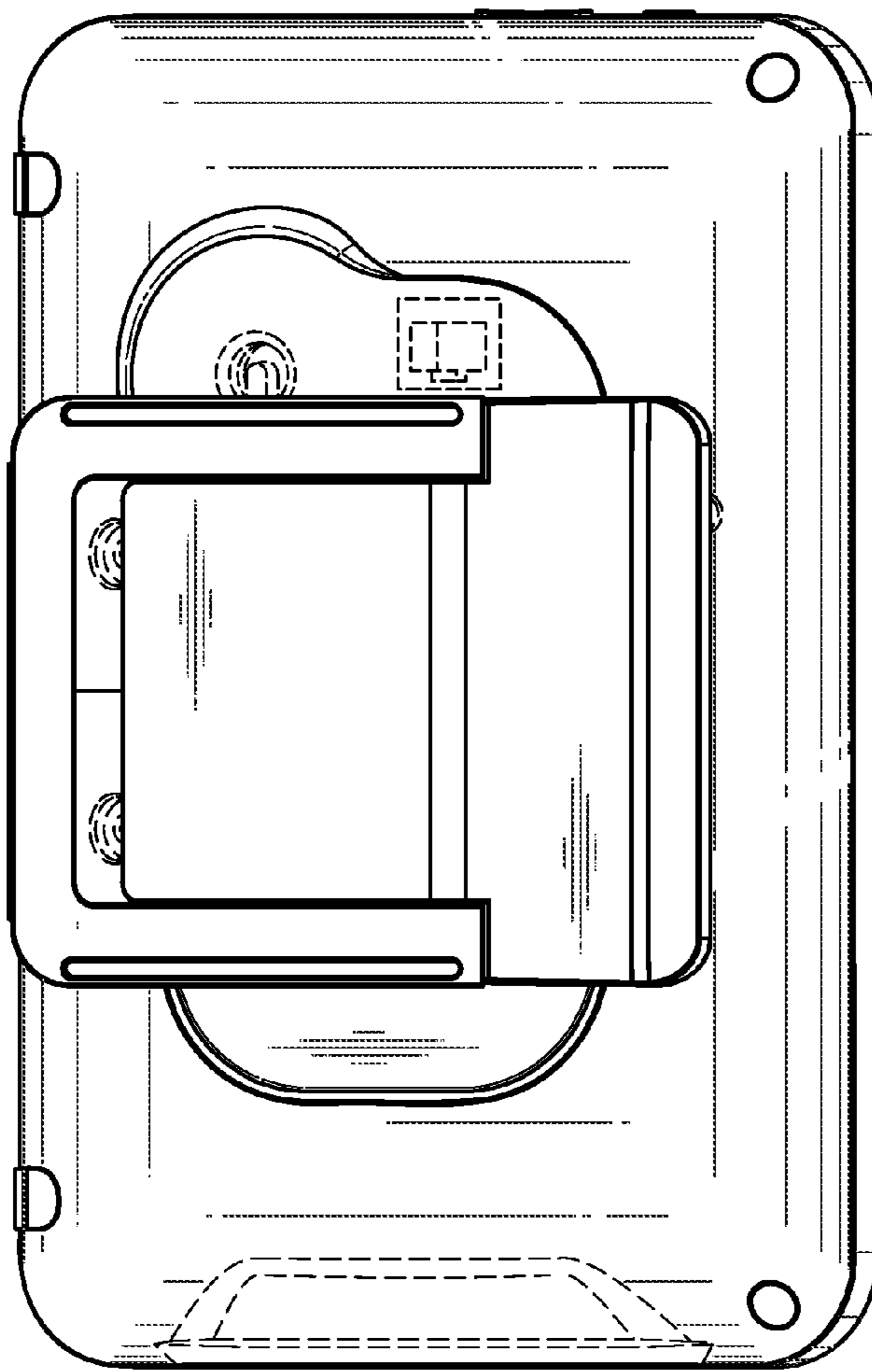

FIG. 3

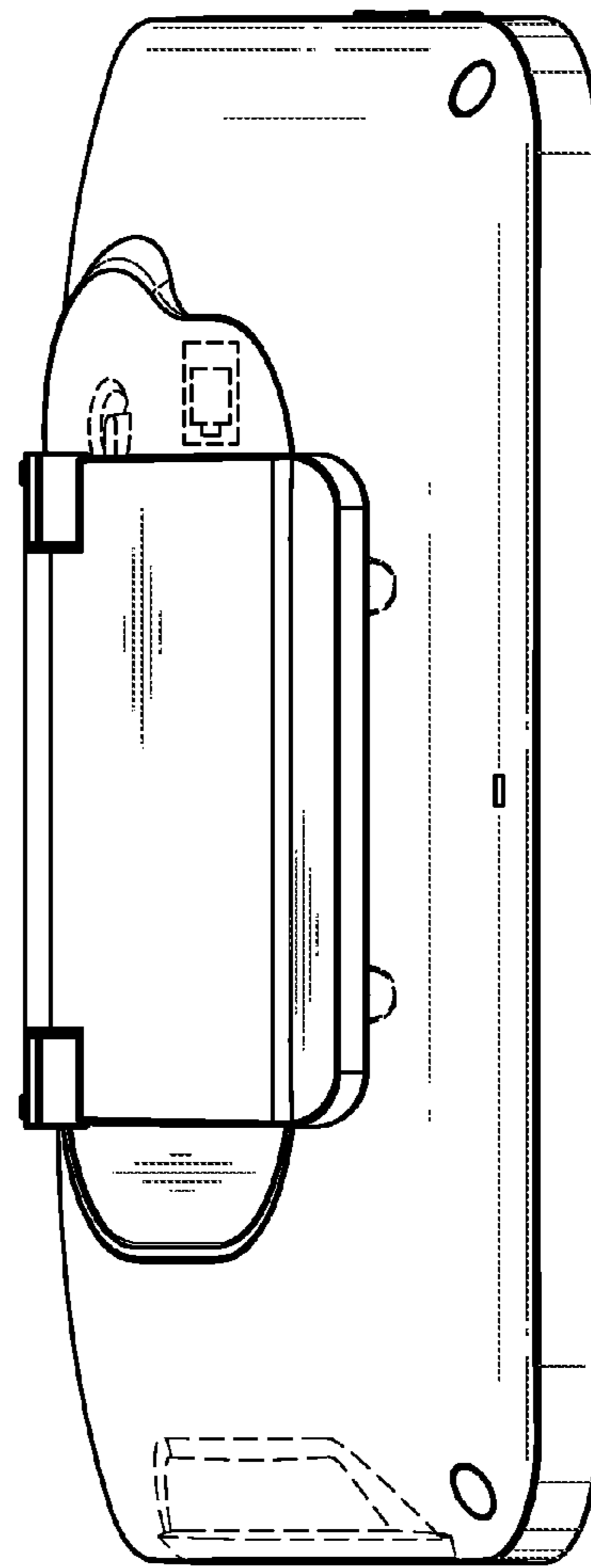

FIG. 4

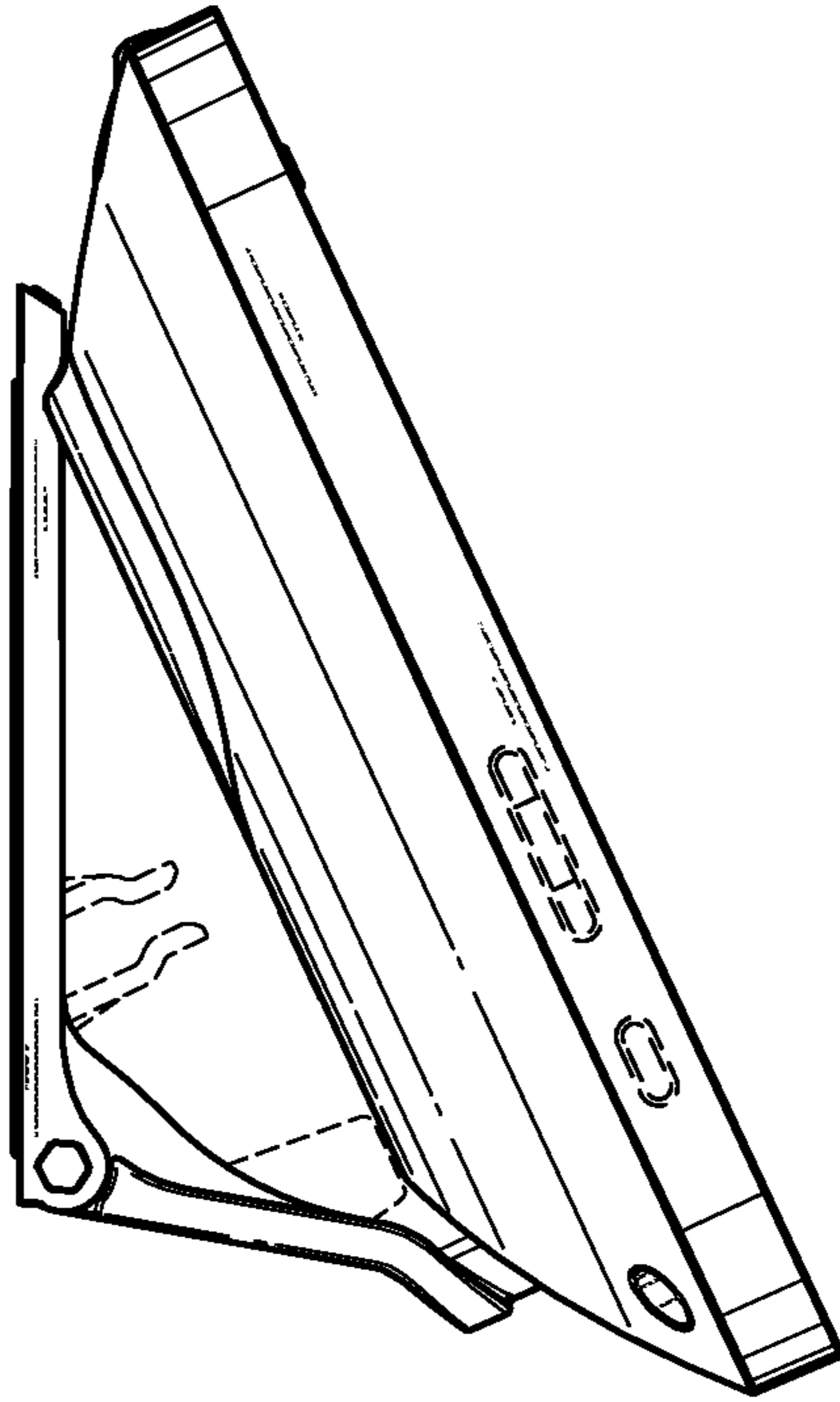

FIG. 5

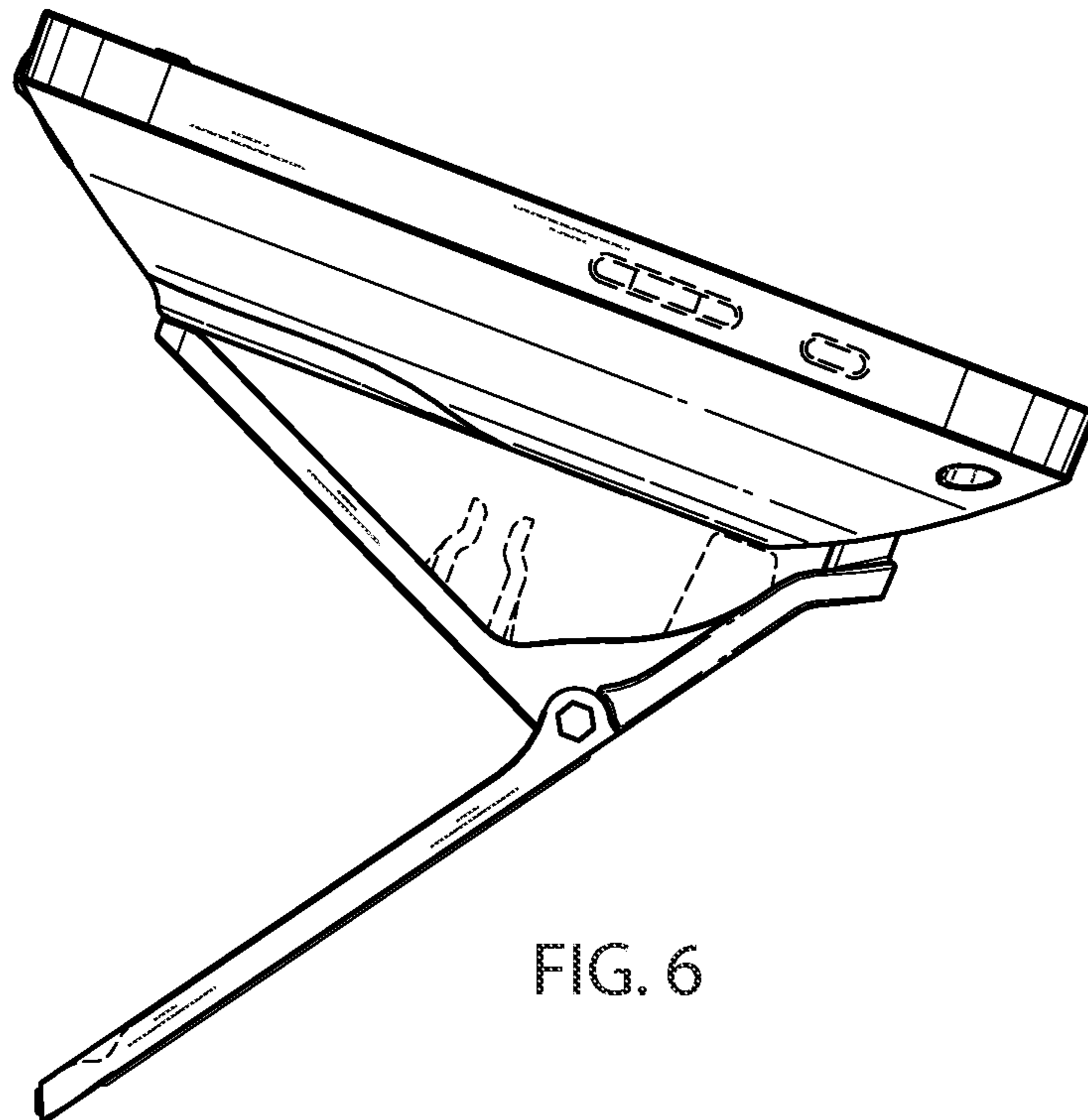

FIG. 6