



US00D684918S

(12) **United States Design Patent**
Krusemark

(10) **Patent No.:** **US D684,918 S**

(45) **Date of Patent:** **** Jun. 25, 2013**

(54) **IN-CAB ACCESSORY MOUNTING KIT FOR VEHICLES**

D413,188 S * 8/1999 Whaley D34/1
D525,935 S * 8/2006 Hussaini et al. D13/108
D546,760 S * 7/2007 Aguilar et al. D13/108

(75) Inventor: **Brad Krusemark**, Pender, NE (US)

* cited by examiner

(73) Assignee: **Automatic Equipment Manufacturing Company**, Pender, NE (US)

Primary Examiner — Katrina A Betton

(74) *Attorney, Agent, or Firm* — Donald R. Schoonover

(**) Term: **14 Years**

(21) Appl. No.: **29/373,845**

(57) **CLAIM**

I claim the ornamental design for in-cab accessory mounting kit for vehicles, as shown and described.

(22) Filed: **May 31, 2011**

(51) **LOC (9) Cl.** **12-16**

(52) **U.S. Cl.**

USPC **D12/415**

(58) **Field of Classification Search**

USPC D12/415-419, 96, 400, 195, 345,
D12/99, 191, 106; 312/246; 296/37.1-37.8,
296/70, 24.1, 24.2, 24.3, 137.1, 97.1, 97.2,
296/97.4, 97.5, 97.6, 97.7, 97.8, 180, 1;
224/311, 539, 281, 118.1, 275; D8/354;
D14/451-452; 248/278.1, 274.1, 284.1;
D9/423; D3/319; 160/370.21, 370.23, 370.22
See application file for complete search history.

DESCRIPTION

This application filed concurrently with pending U.S. patent application Ser. No. 13/134,112.

FIG. 1 is a perspective view of an in-cab accessory mounting kit for vehicles showing my new design;

FIG. 2 is a front elevational view thereof;

FIG. 3 is a rear elevational view thereof;

FIG. 4 is a left side elevational view thereof;

FIG. 5 is a right side elevational view thereof;

FIG. 6 is a top plan view thereof;

FIG. 7 is a bottom plan view thereof;

FIG. 8 is a front elevational view of the in-cab accessory mounting kit for vehicles in use; and,

FIG. 9 is a perspective view showing the in-cab accessory mounting kit for vehicles with a pad.

The broken lines in FIG. 8 depict environmental structure for illustrative purposes only and form no part of the claimed design.

(56) **References Cited**

U.S. PATENT DOCUMENTS

D247,110 S 1/1978 Olivan
D247,111 S 1/1978 Olivan
D247,112 S 1/1978 Olivan
D247,812 S 5/1978 Olivan
4,099,813 A 7/1978 Olivan
D369,953 S * 5/1996 Carr D8/353

1 Claim, 2 Drawing Sheets

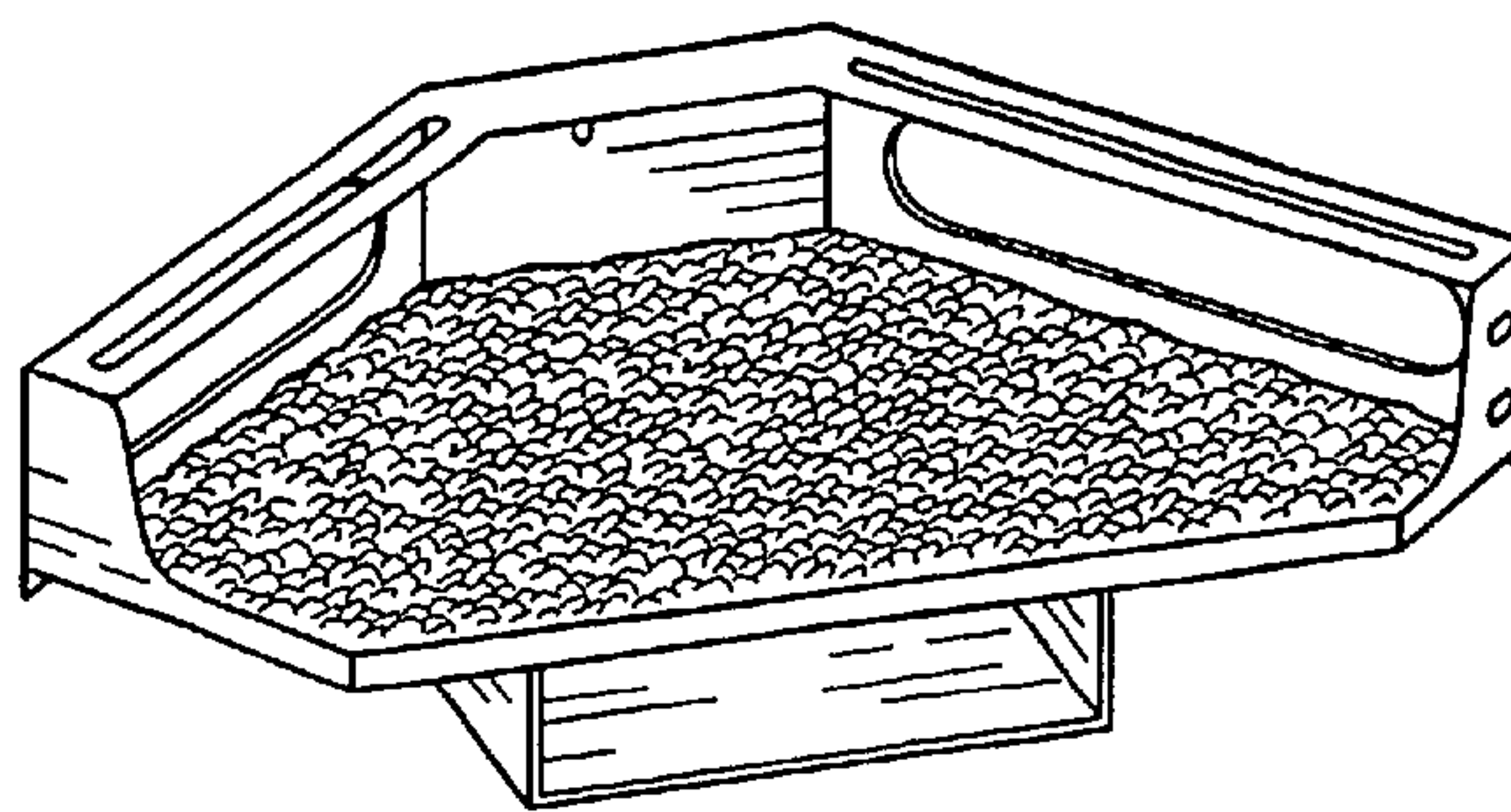
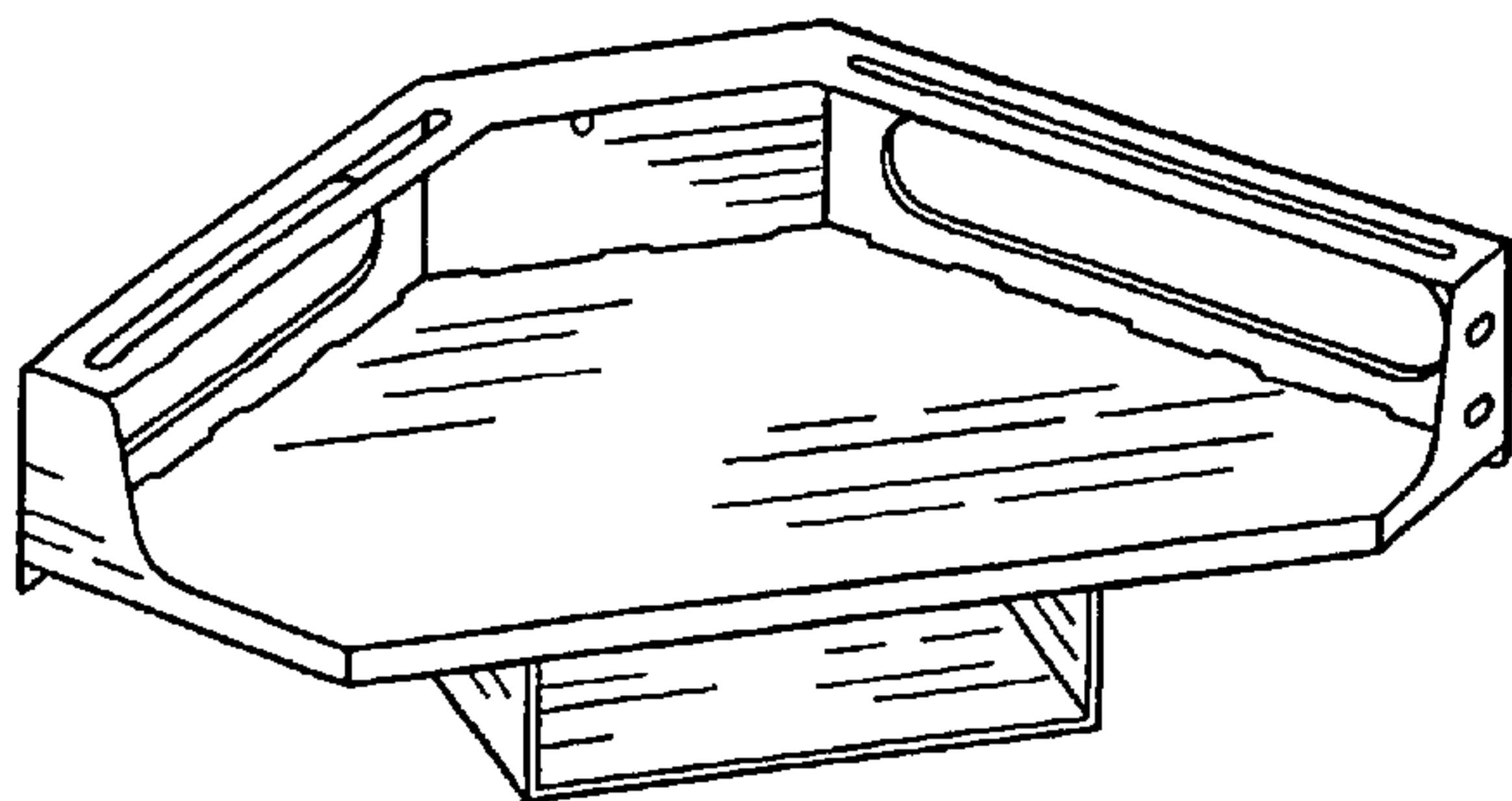

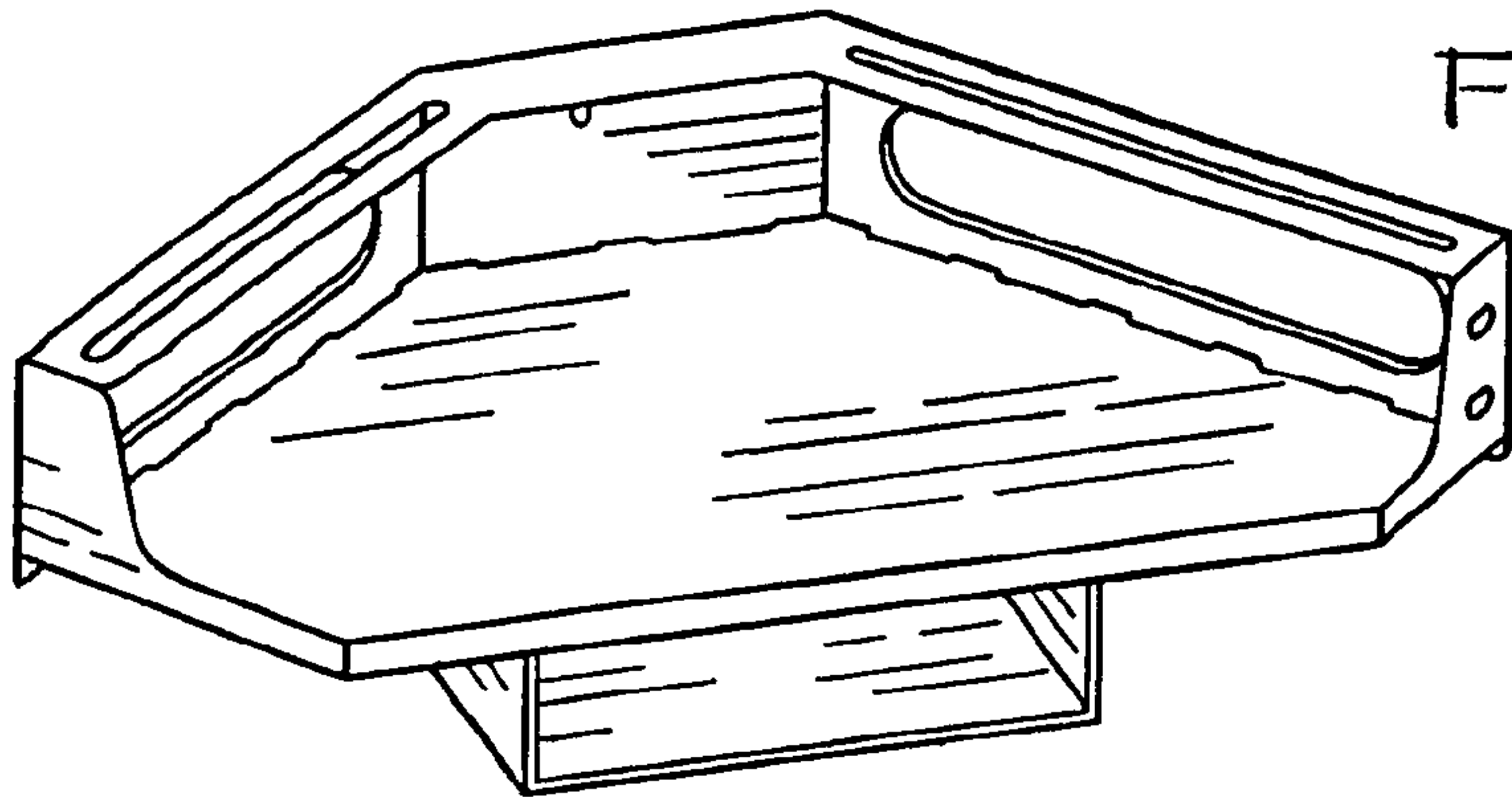

Fig. 1

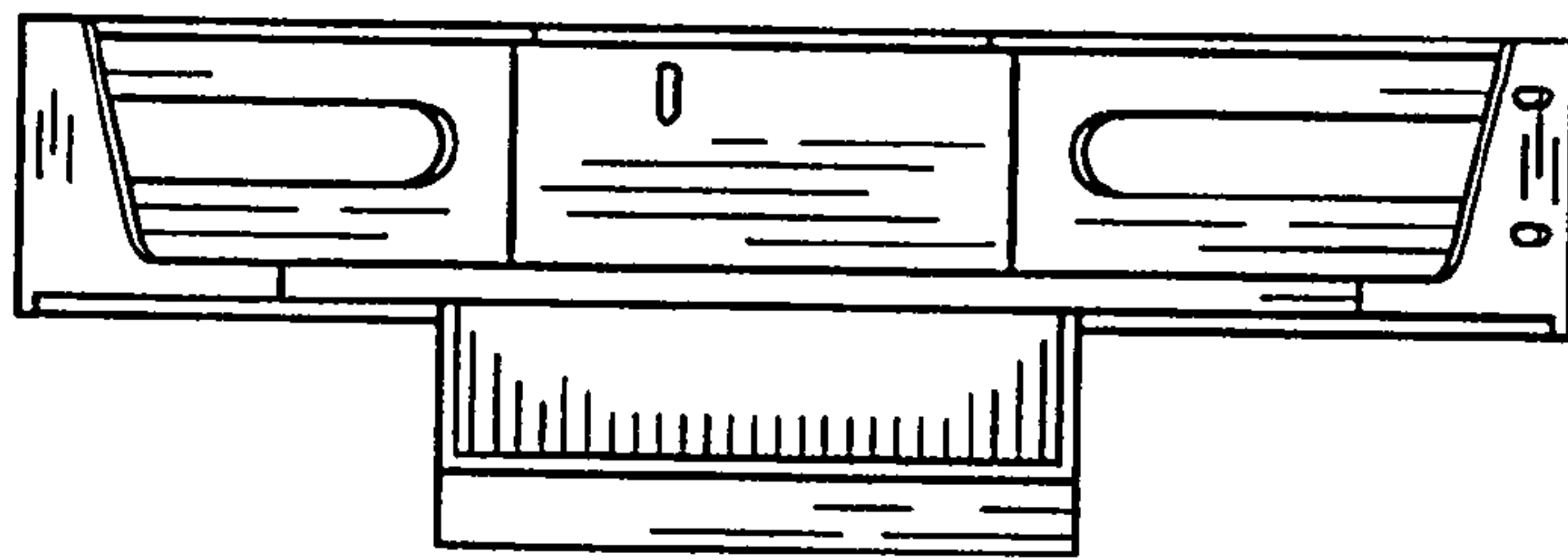

Fig. 2

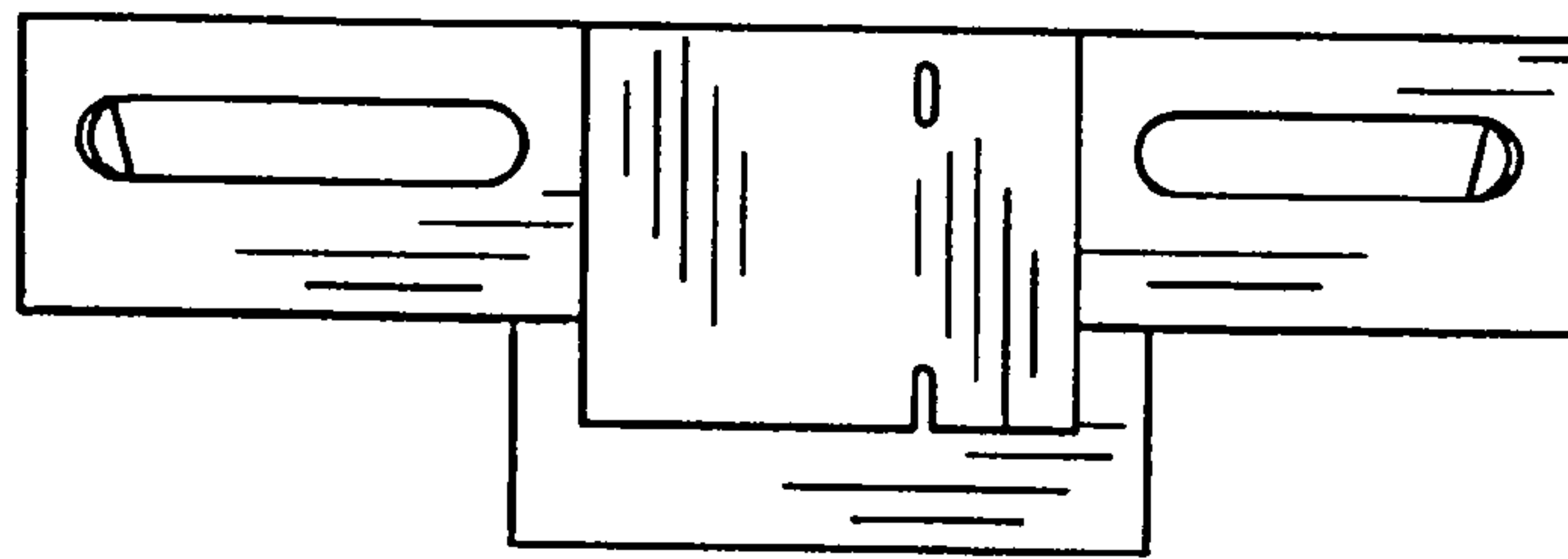

Fig. 3

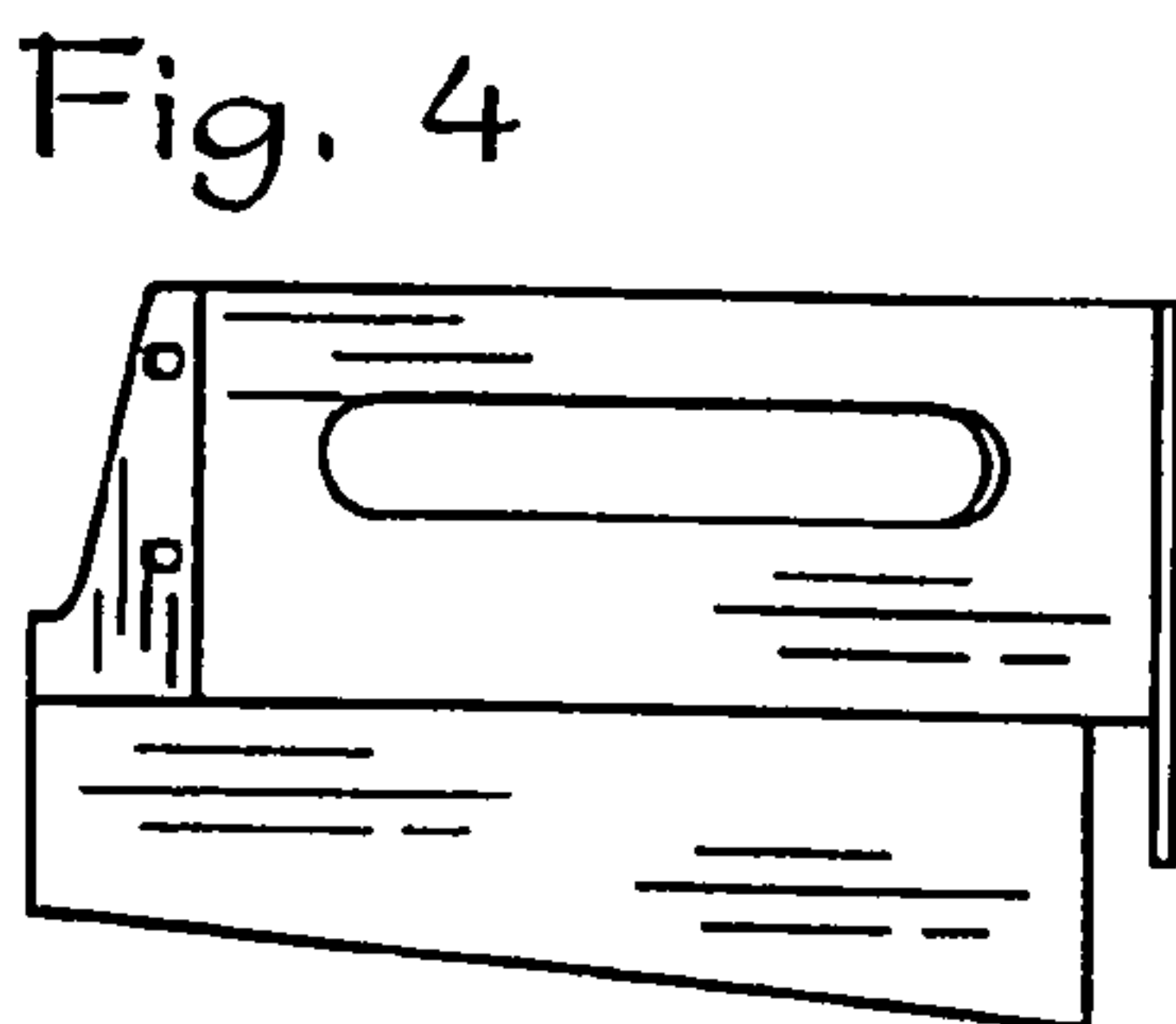

Fig. 4

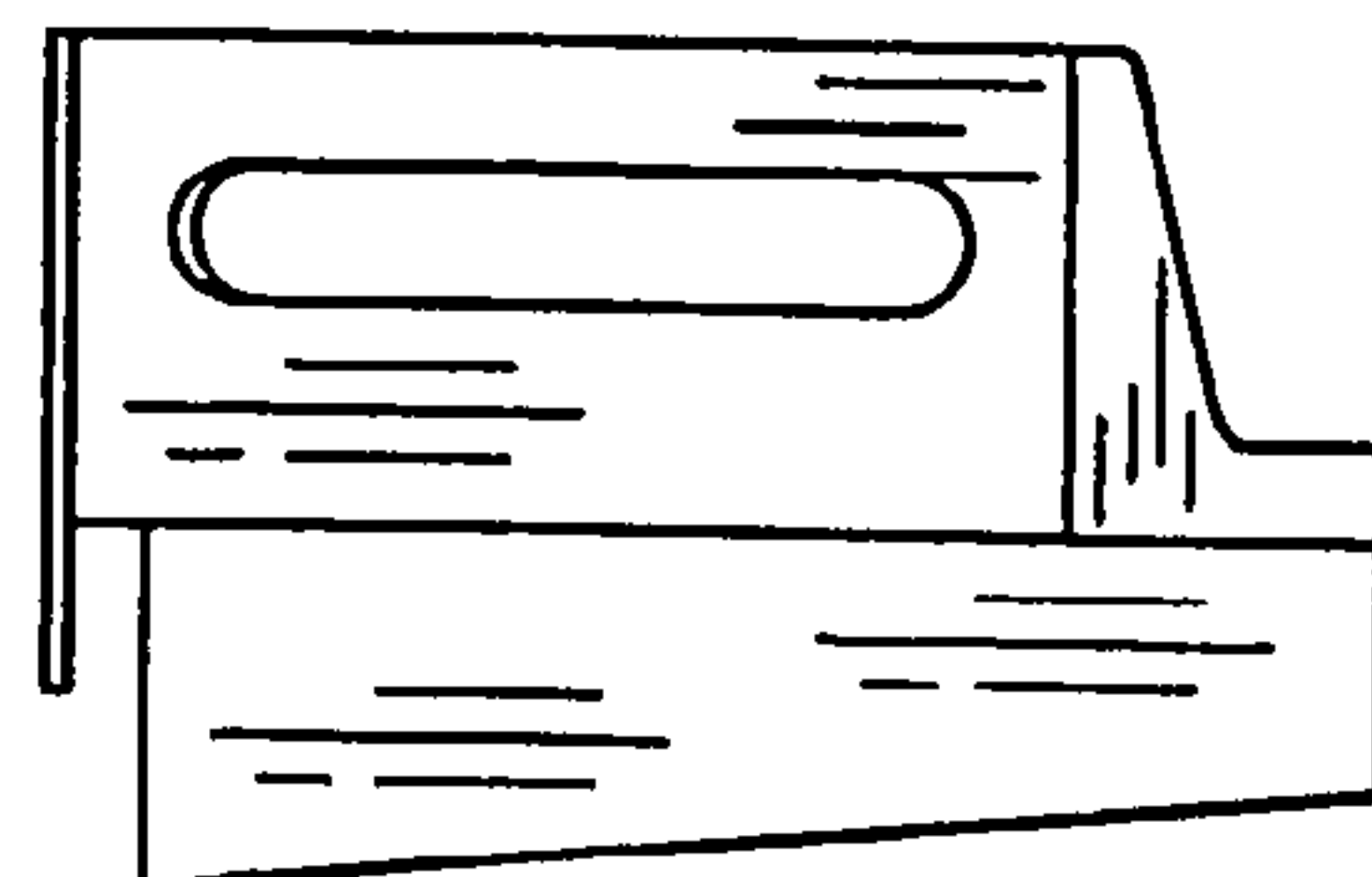

Fig. 5

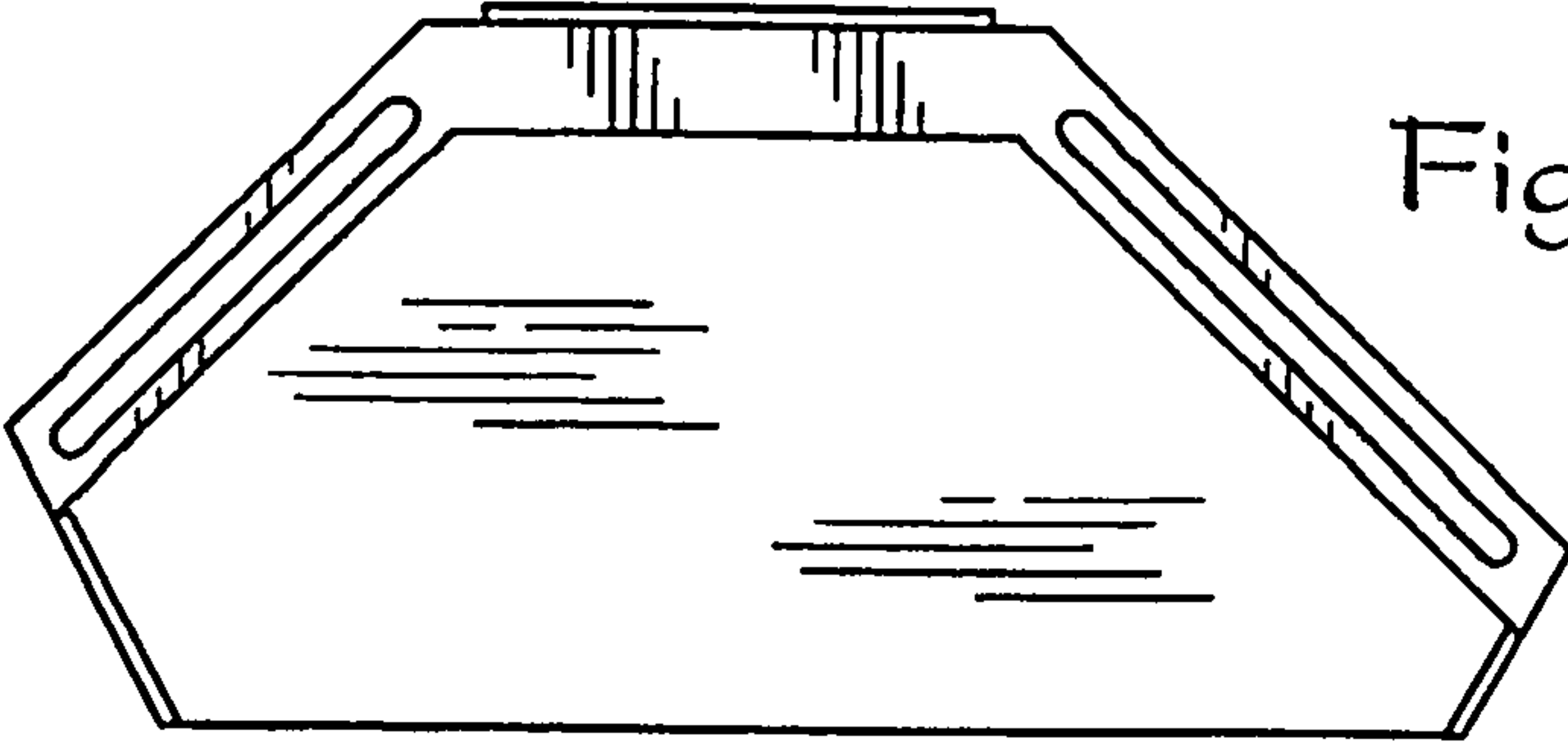

Fig. 6

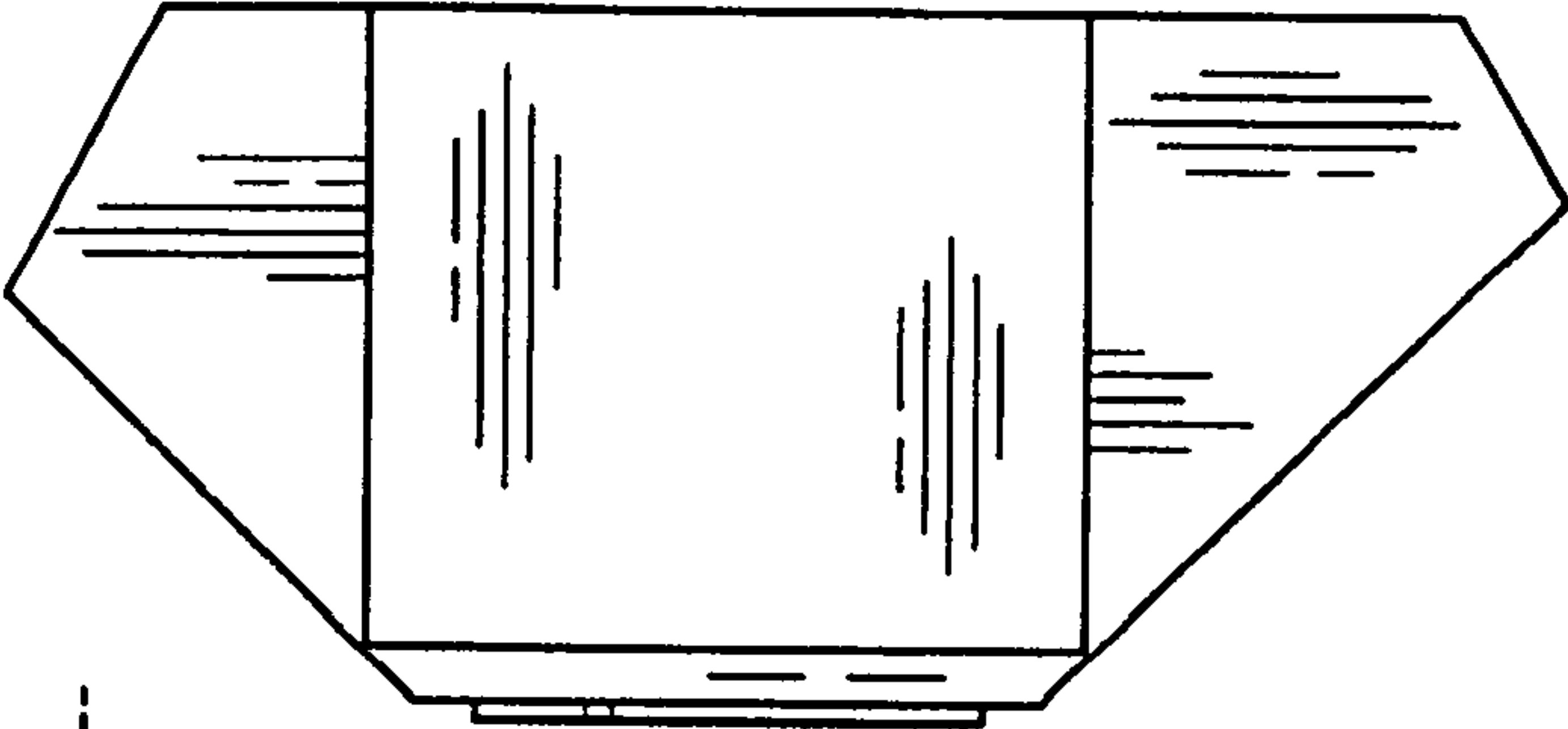

Fig. 7

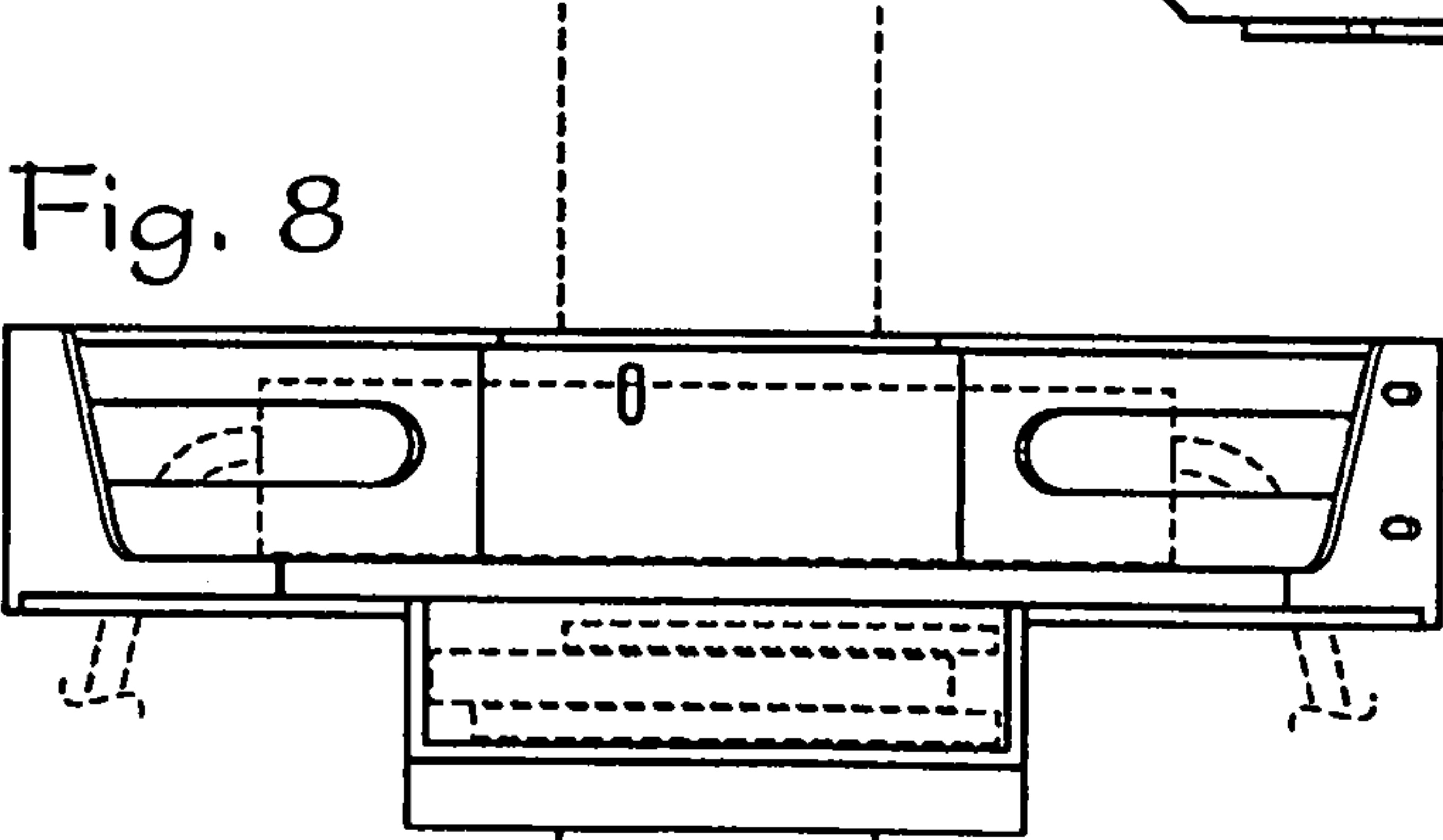

Fig. 8

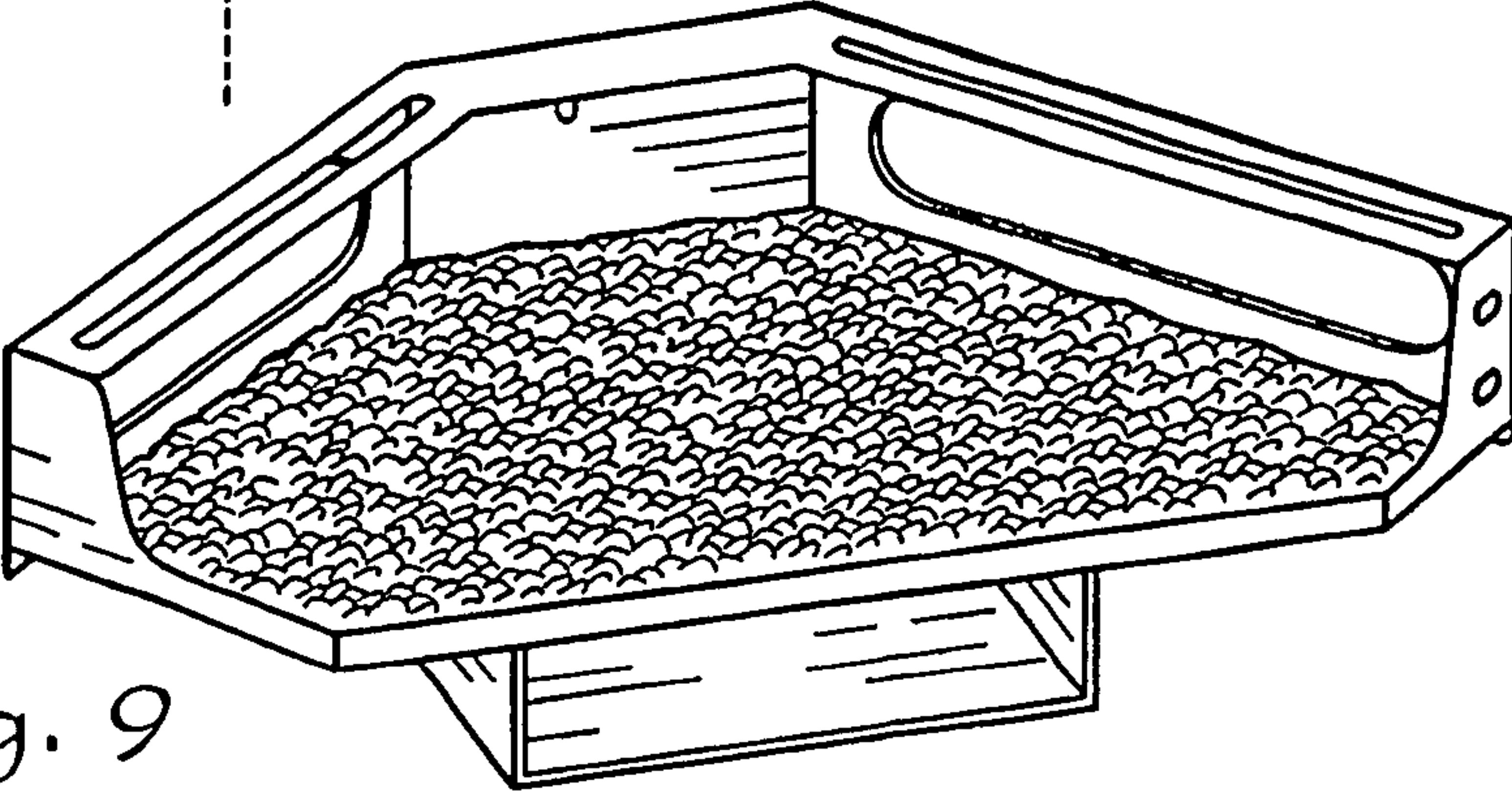

Fig. 9