



US00D684882S

(12) **United States Design Patent**
O’Conor

(10) **Patent No.:** **US D684,882 S**
(45) **Date of Patent:** **** Jun. 25, 2013**

(54) **ARTICLE OF JEWELRY**
(75) Inventor: **Harvey O’Conor**, Harrisville, NH (US)
(73) Assignee: **Findings, Inc.**, Keene, NH (US)
(**) Term: **14 Years**
(21) Appl. No.: **29/387,344**
(22) Filed: **Mar. 11, 2011**
(51) **LOC (9) Cl.** **11-01**
(52) **U.S. Cl.**
USPC **D11/86**
(58) **Field of Classification Search**
USPC D11/40–51, 67, 79–92, 143, 146,
D11/1, 2; 63/12, 13, 14.1–14.8, 26–28, 29.1,
63/35; D6/462, 499; D19/65; 47/41.13, 47
See application file for complete search history.

(56) **References Cited**

U.S. PATENT DOCUMENTS
148,390 A * 3/1874 Tappan 63/13
517,265 A * 3/1894 D’arcy 63/27
(Continued)

OTHER PUBLICATIONS

14KT White Gold Lady Diamond Backless Stud Earrings; Amazon.
com; Published Nov. 2010; retrieved Oct. 31, 2012 (4 pages).
(Continued)

Primary Examiner — Jennifer Rivard
Assistant Examiner — Melanie Levy
(74) *Attorney, Agent, or Firm* — Wilmer Cutler Pickering
Hale & Dorr LLP.

(57) **CLAIM**
The ornamental design for an article of jewelry, as shown and
described.

DESCRIPTION

FIG. 1 is a perspective view of a first embodiment of an article
of jewelry.

FIG. 2 is a bottom view thereof;
FIG. 3 is a top view thereof;
FIG. 4 is a left side view thereof;
FIG. 5 is a right side view thereof;
FIG. 6 is a front view thereof; and
FIG. 7 is a back view thereof.
FIG. 8 is a perspective view of a second embodiment of an
article of jewelry.
FIG. 9 is a bottom view thereof;
FIG. 10 is a top view thereof;
FIG. 11 is a left side view thereof;
FIG. 12 is a right side view thereof;
FIG. 13 is a front view thereof; and
FIG. 14 is a back view thereof.
FIG. 15 is a perspective view of a third embodiment of an
article of jewelry.
FIG. 16 is a bottom view thereof;
FIG. 17 is a top view thereof;
FIG. 18 is a right side view thereof;
FIG. 19 is a left side view thereof;
FIG. 20 is a front view thereof; and
FIG. 21 is a back view thereof.
FIG. 22 is a perspective view of a fourth embodiment of an
article of jewelry.
FIG. 23 is a bottom view thereof;
FIG. 24 is a top view thereof;
FIG. 25 is a right side view thereof;
FIG. 26 is a left side view thereof;
FIG. 27 is a front view thereof; and,
FIG. 28 is a back view thereof.
The broken lines in the figures are included for the purpose of
illustrating the environment and form no part of the claimed
design.
The cylindrical element is shown with a cut away portion to
indicate a non-specified length.

1 Claim, 8 Drawing Sheets

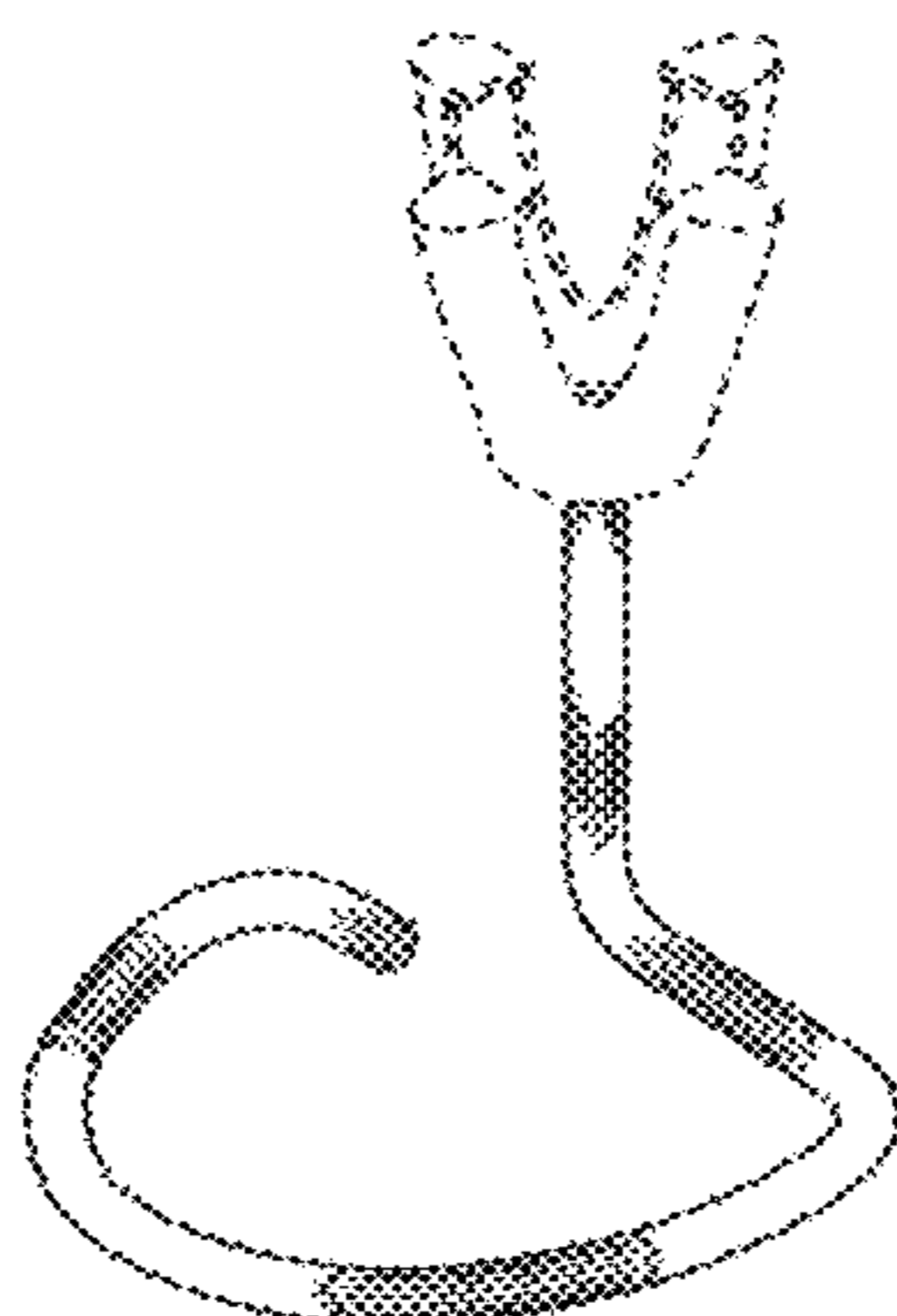

US D684,882 S

Page 2

U.S. PATENT DOCUMENTS

1,812,737 A * 6/1931 Coughlin et al. 47/41.01
2,021,303 A * 11/1935 Grennan 47/47
D97,712 S * 12/1935 Orben D11/147
2,083,526 A * 6/1937 Rinker 47/47
2,173,217 A * 9/1939 Thomsen 47/47
D175,867 S * 10/1955 Sustain D11/86
D228,327 S * 9/1973 Court D6/462
D267,679 S * 1/1983 Barney D6/417
D281,767 S * 12/1985 Mason D11/78
4,595,007 A * 6/1986 Mericle 606/221
D293,217 S * 12/1987 O'Donovan D11/78
D298,611 S * 11/1988 Saraga D11/42
D304,433 S * 11/1989 McConnell, Jr. D11/78
D305,874 S * 2/1990 Jackson D11/1
4,976,431 A * 12/1990 Guenther 473/417
5,074,128 A * 12/1991 Kowalski 63/12
D324,350 S * 3/1992 Owens, Jr. D11/78
D348,854 S * 7/1994 Salsgiver D11/86
D368,671 S * 4/1996 Ross D11/78

D378,808 S * 4/1997 Shechter D11/40
5,638,700 A 6/1997 Shechter
D400,612 S * 11/1998 Rubin D21/796
D419,632 S * 1/2000 Ashcroft D21/796
D441,222 S * 5/2001 Higazy D6/462
D451,049 S * 11/2001 Bjornbråten D11/143
D496,221 S * 9/2004 Hester D7/409
D527,300 S * 8/2006 Ppngonis D11/86
D528,938 S * 9/2006 Pongonis D11/86
D531,928 S * 11/2006 Pongonis D11/86
D536,490 S * 2/2007 Colvin et al. D30/199
D562,027 S * 2/2008 Ackerson D6/403
D608,239 S * 1/2010 McCarty-O'Brien D11/86

OTHER PUBLICATIONS

Solid 14KT White Gold 1.5 mm Genuine Diamond Left Nostril
Screw—18 Gauge; Amazon.com; Published Nov. 2010; retrieved
Oct. 31, 2012 (3 pages).

* cited by examiner

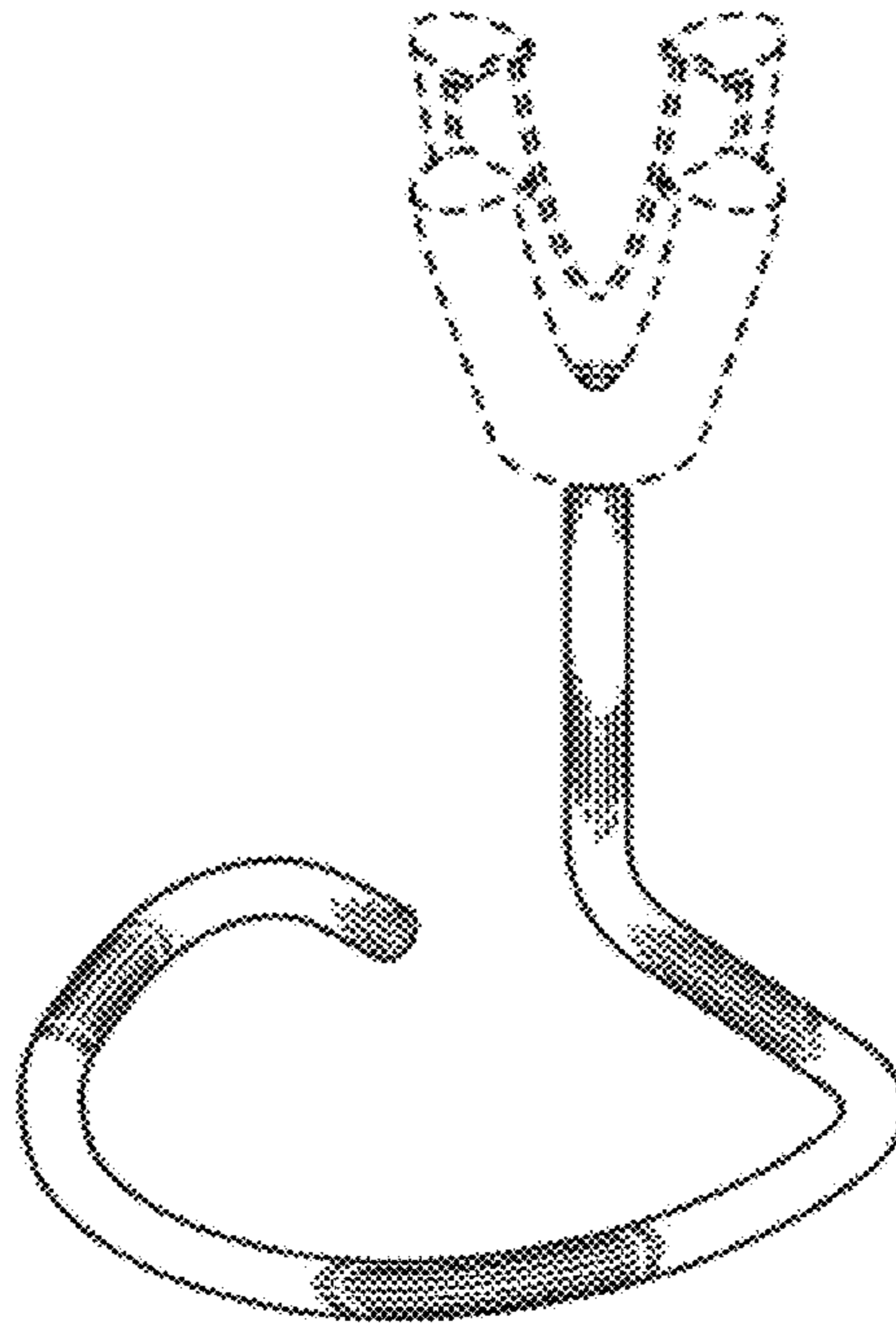

FIG. 1

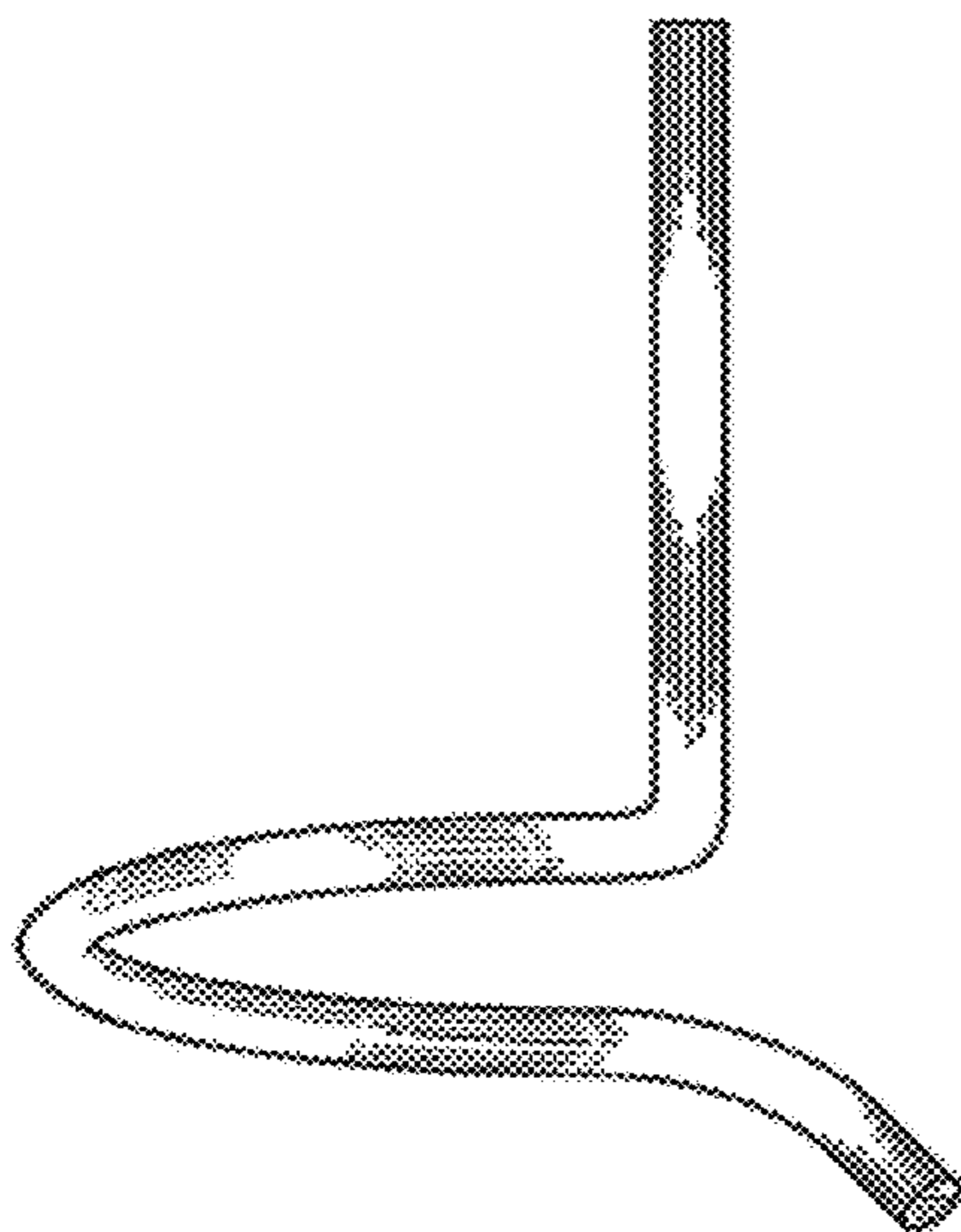

FIG. 2

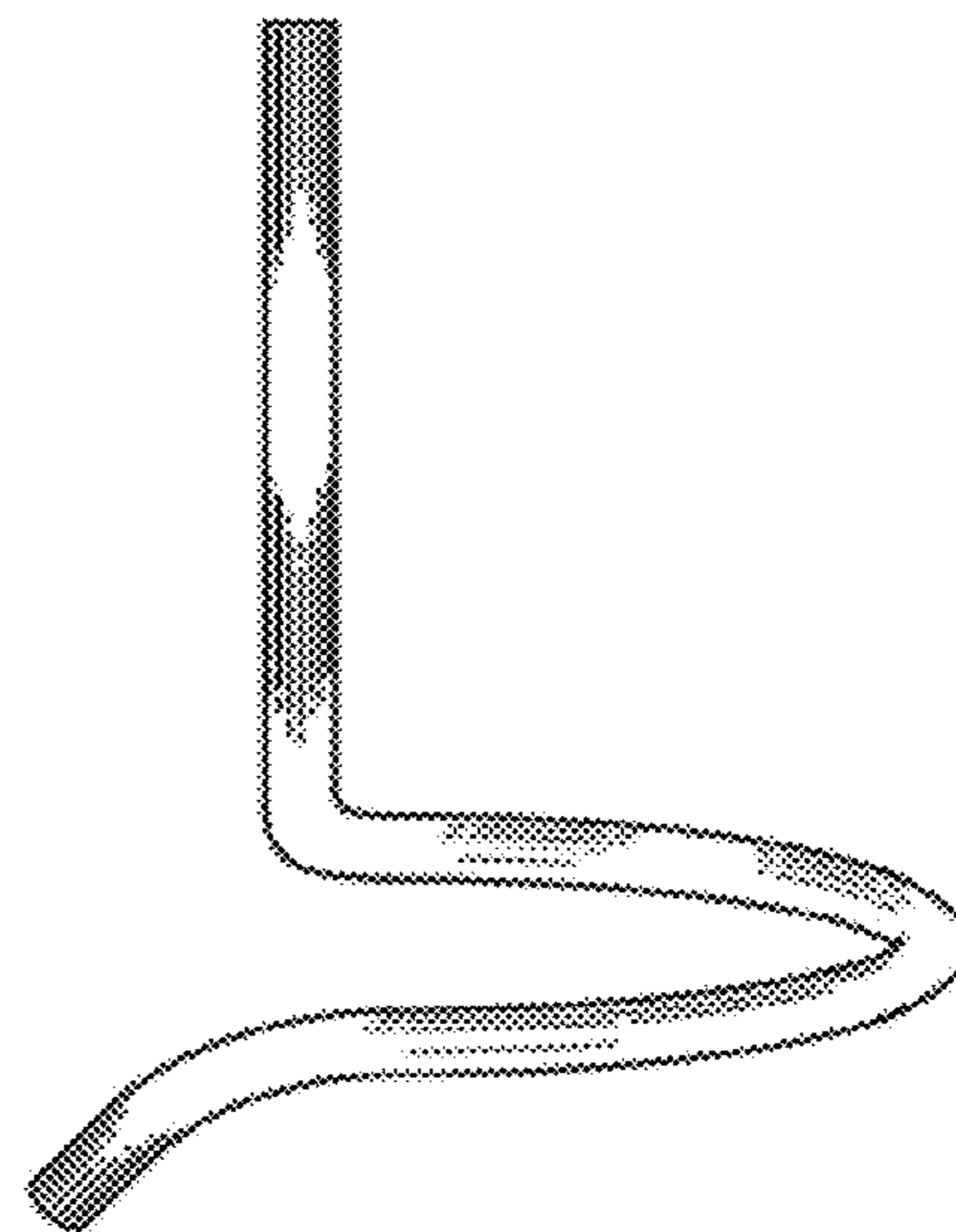

FIG. 3

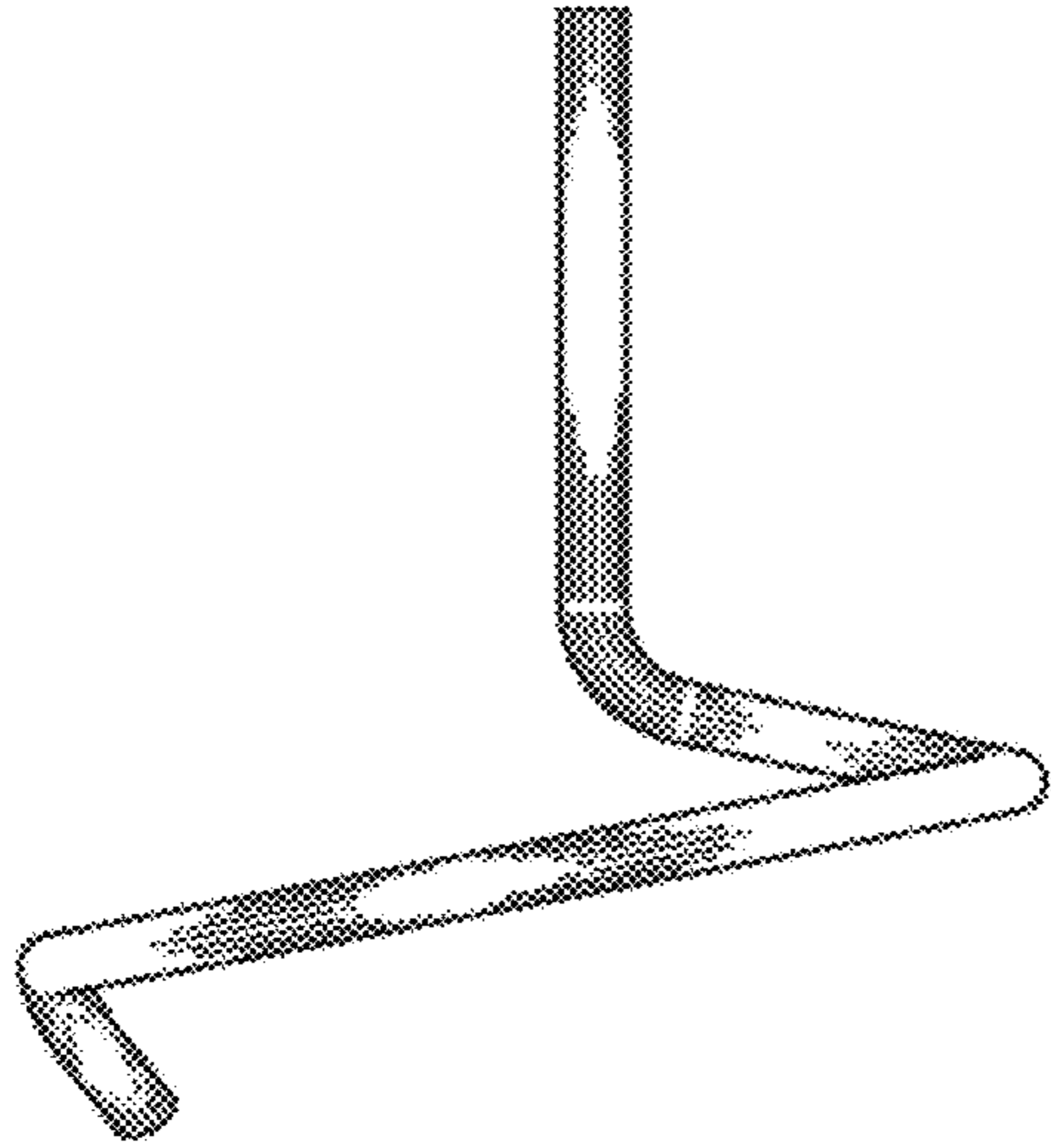

FIG. 4

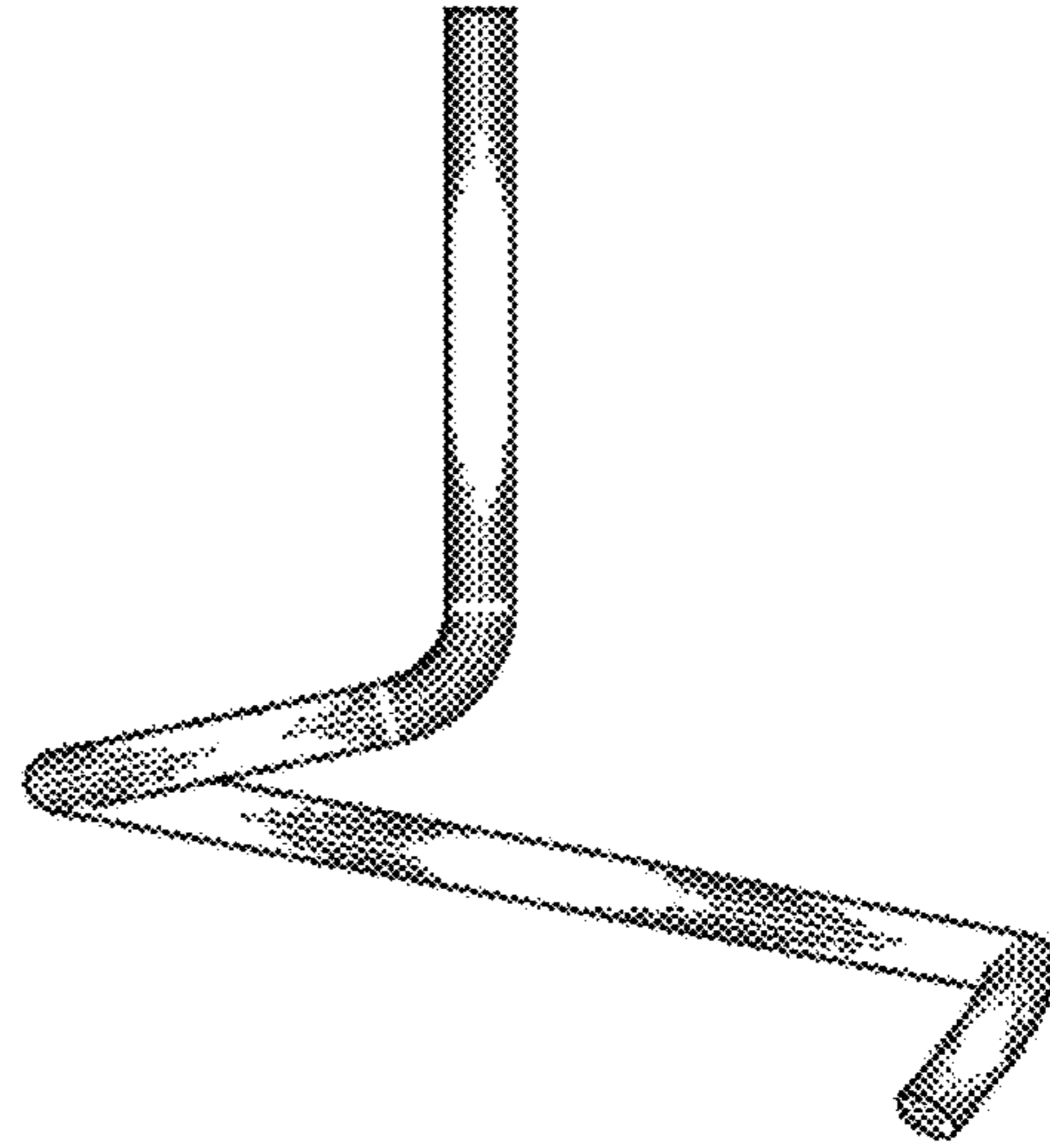

FIG. 5

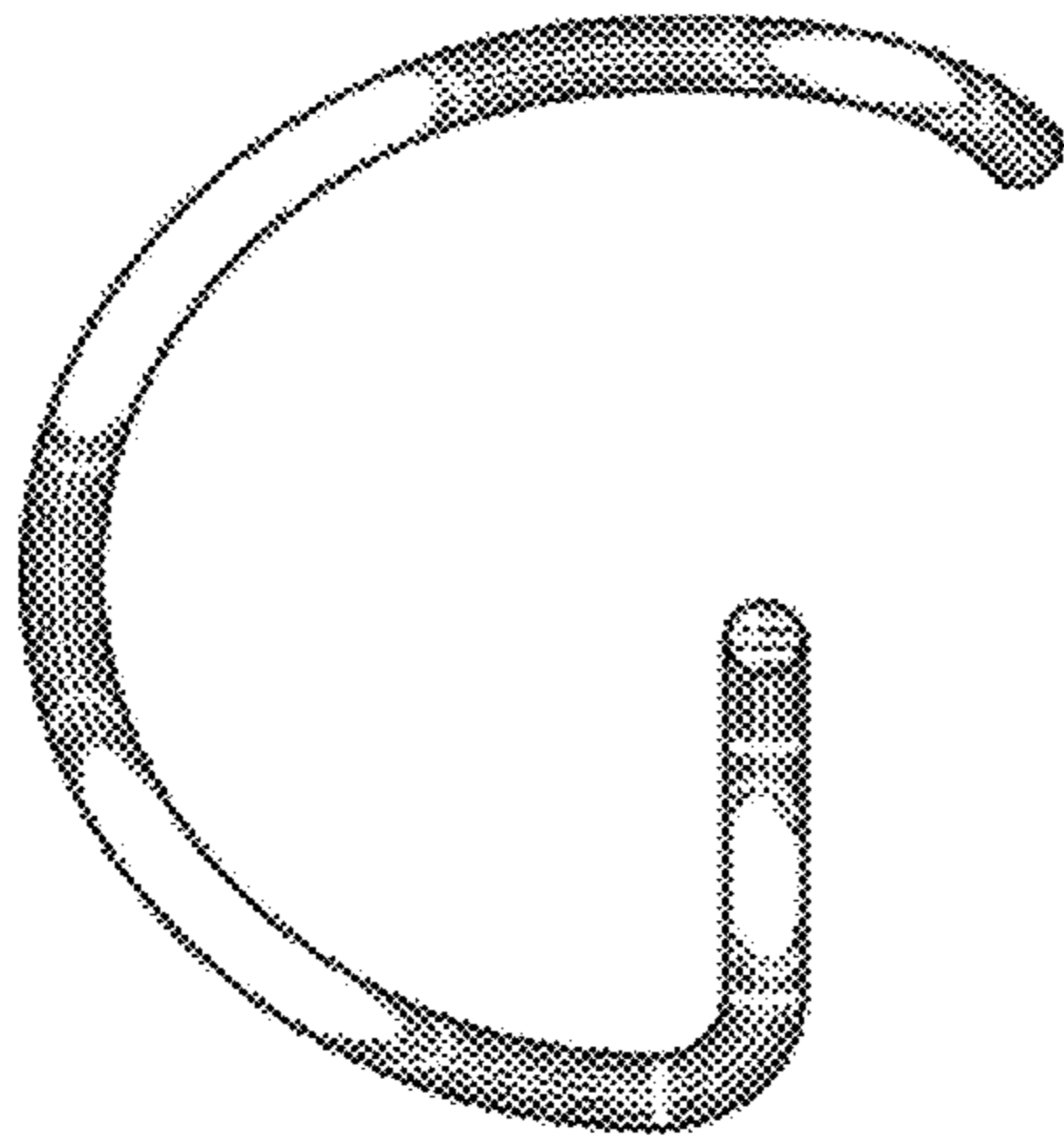

FIG. 6

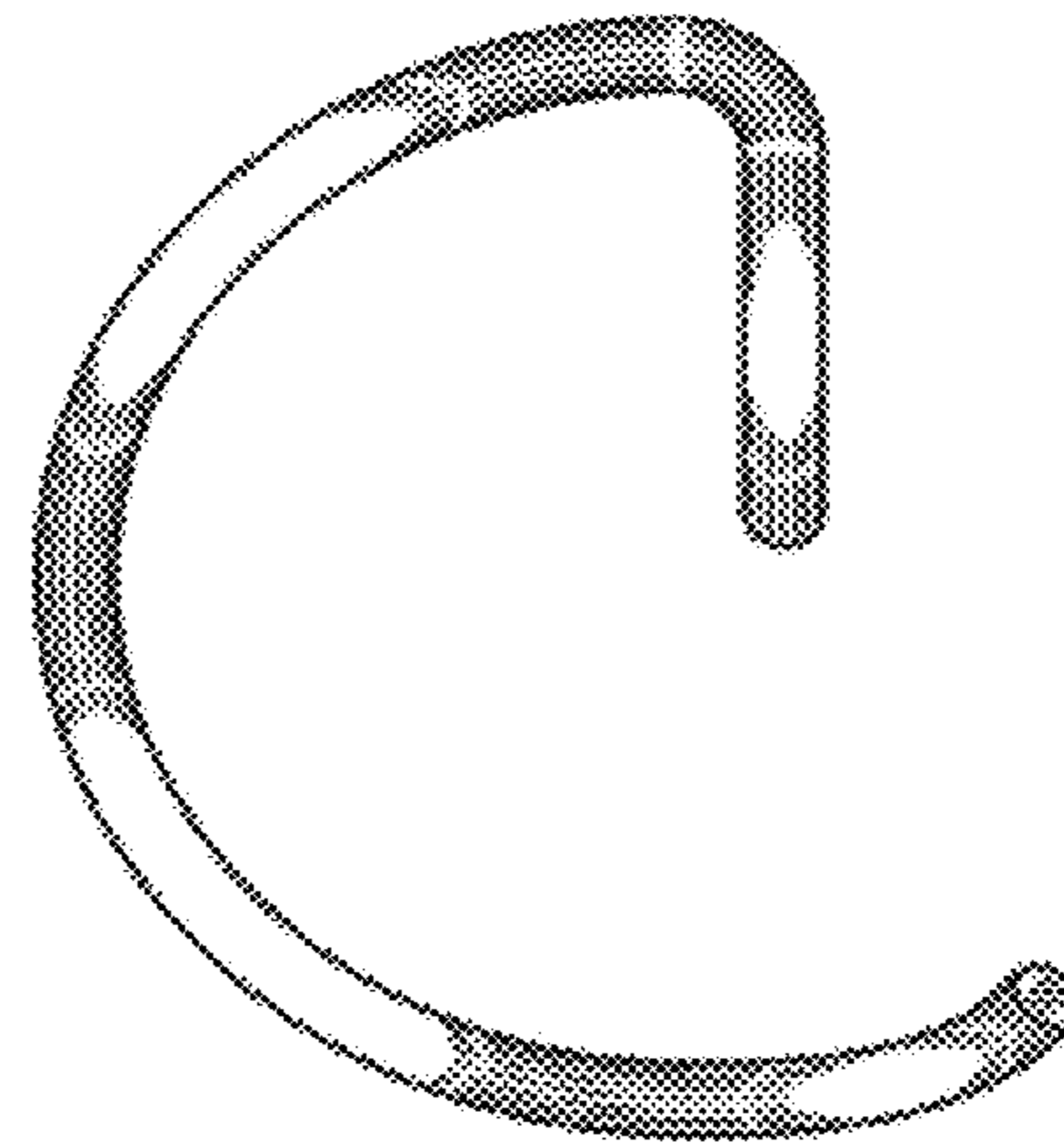

FIG. 7

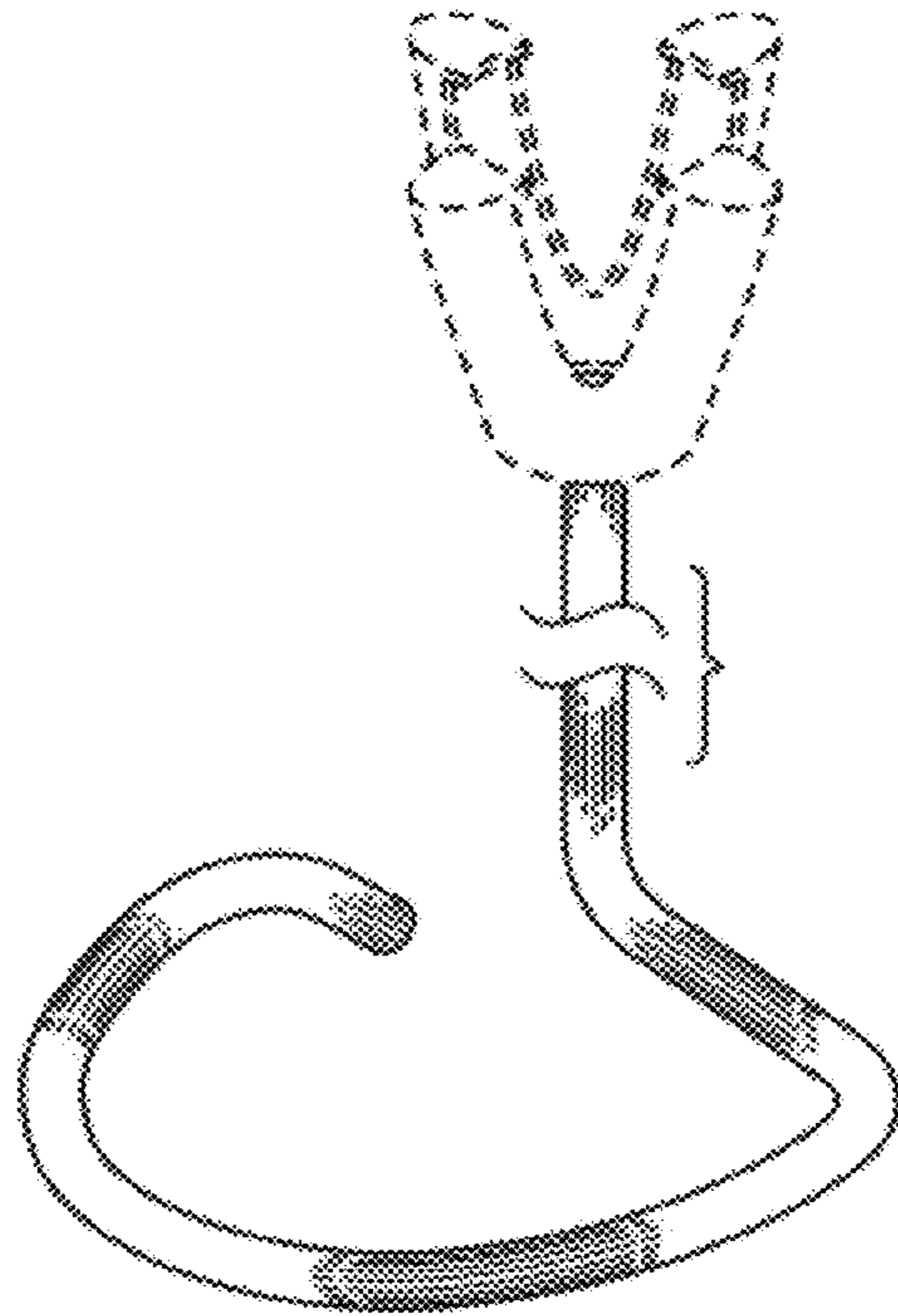

FIG. 8

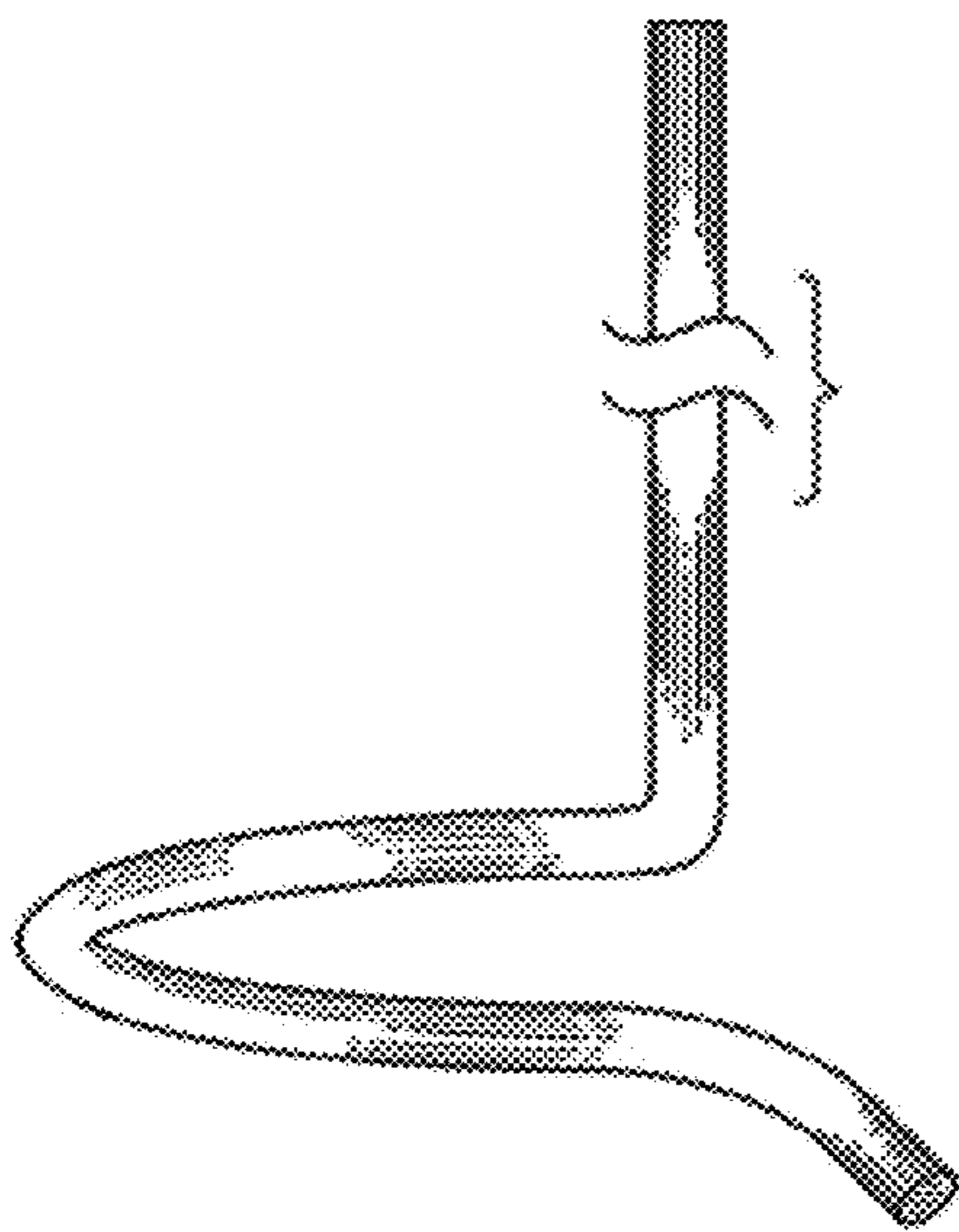

FIG. 9

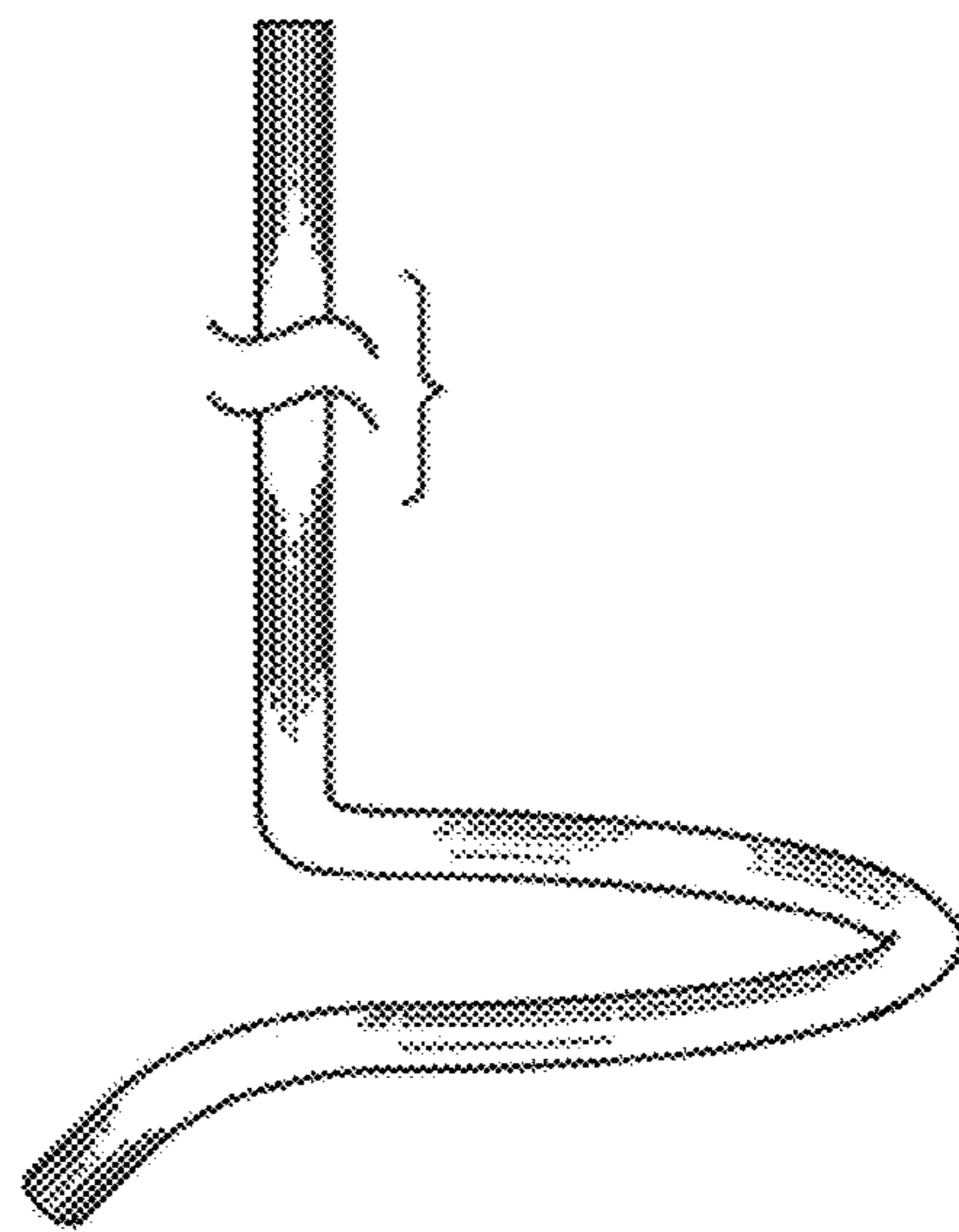

FIG. 10

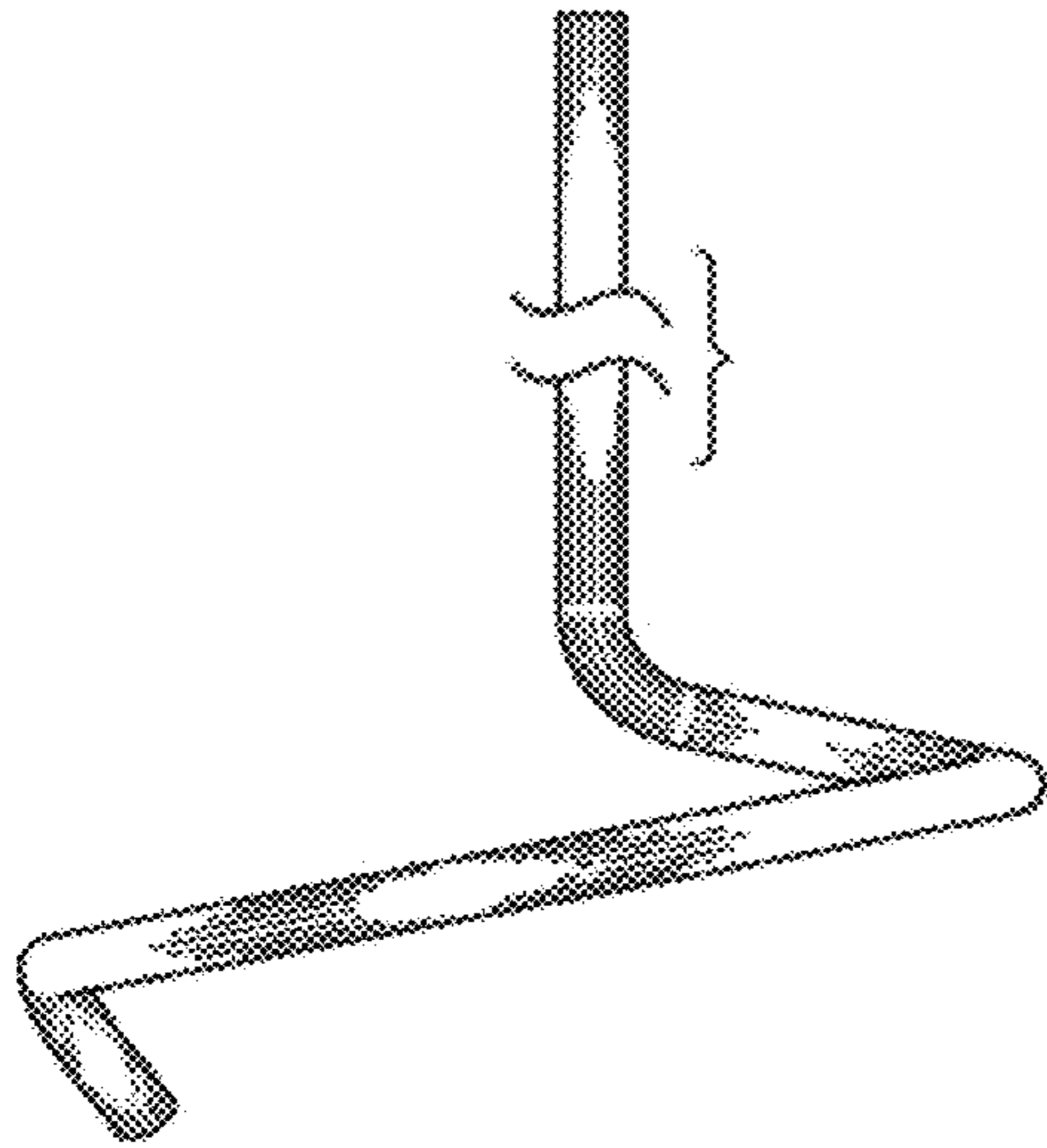

FIG. 11

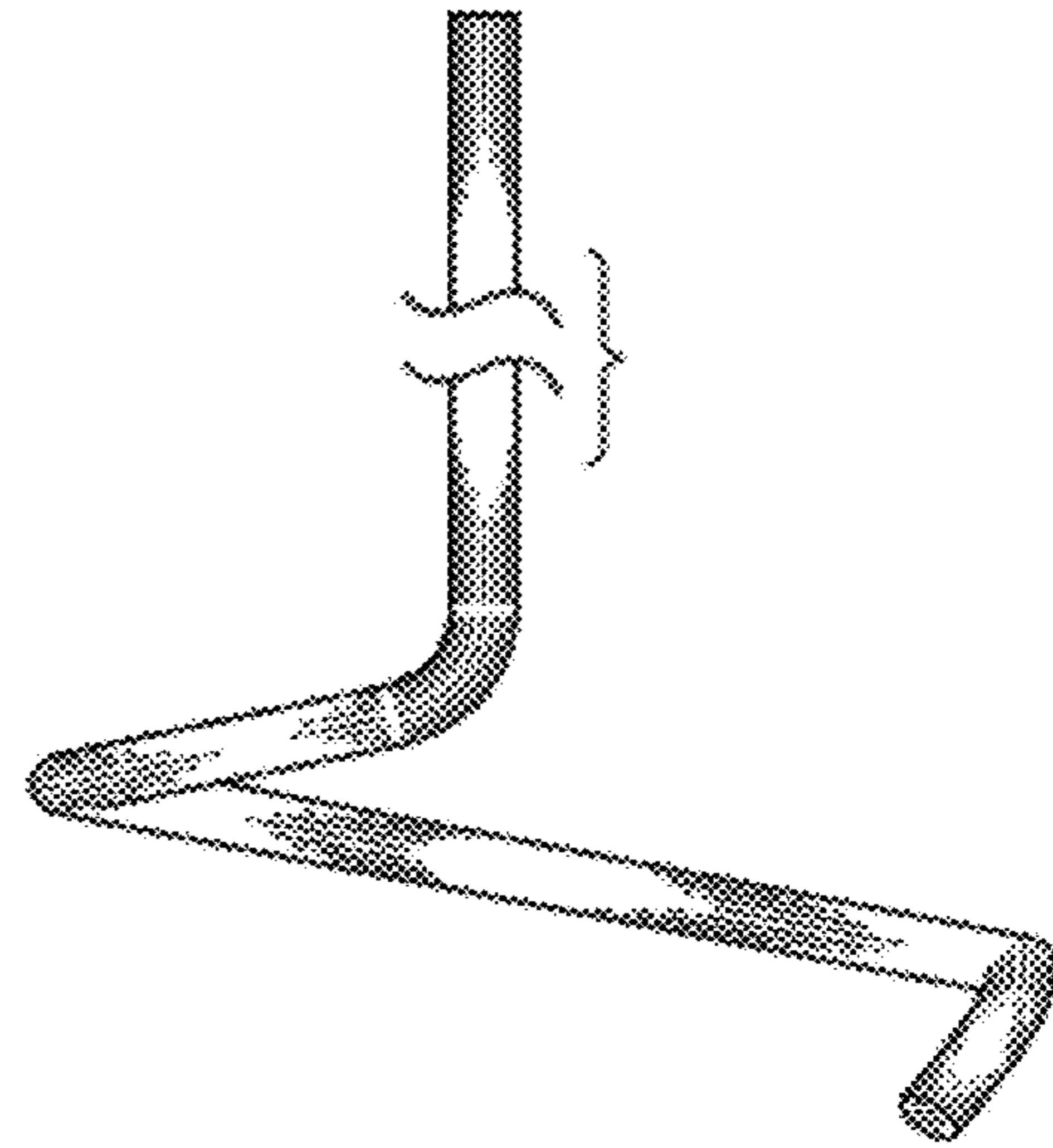

FIG. 12

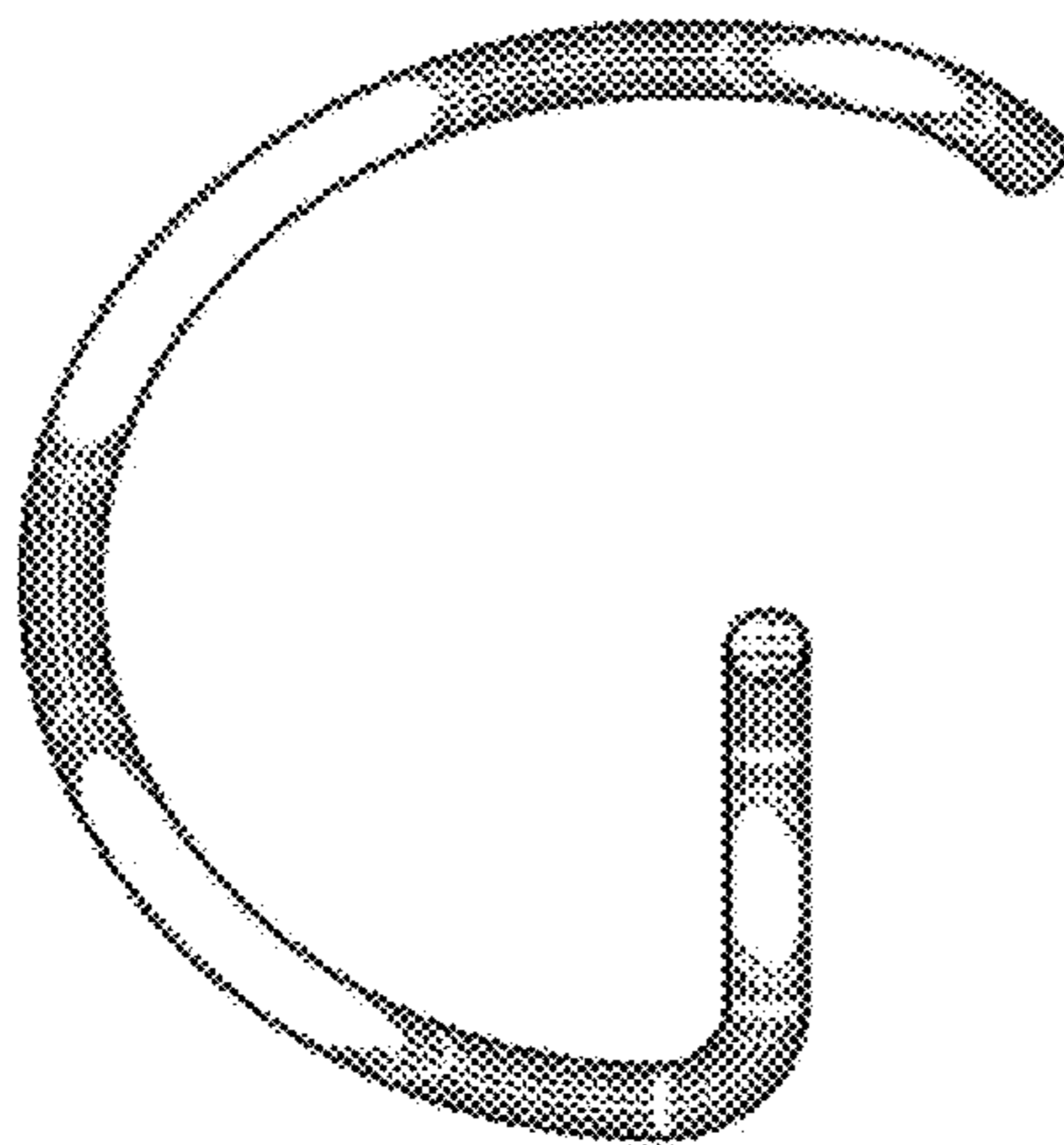

FIG. 13

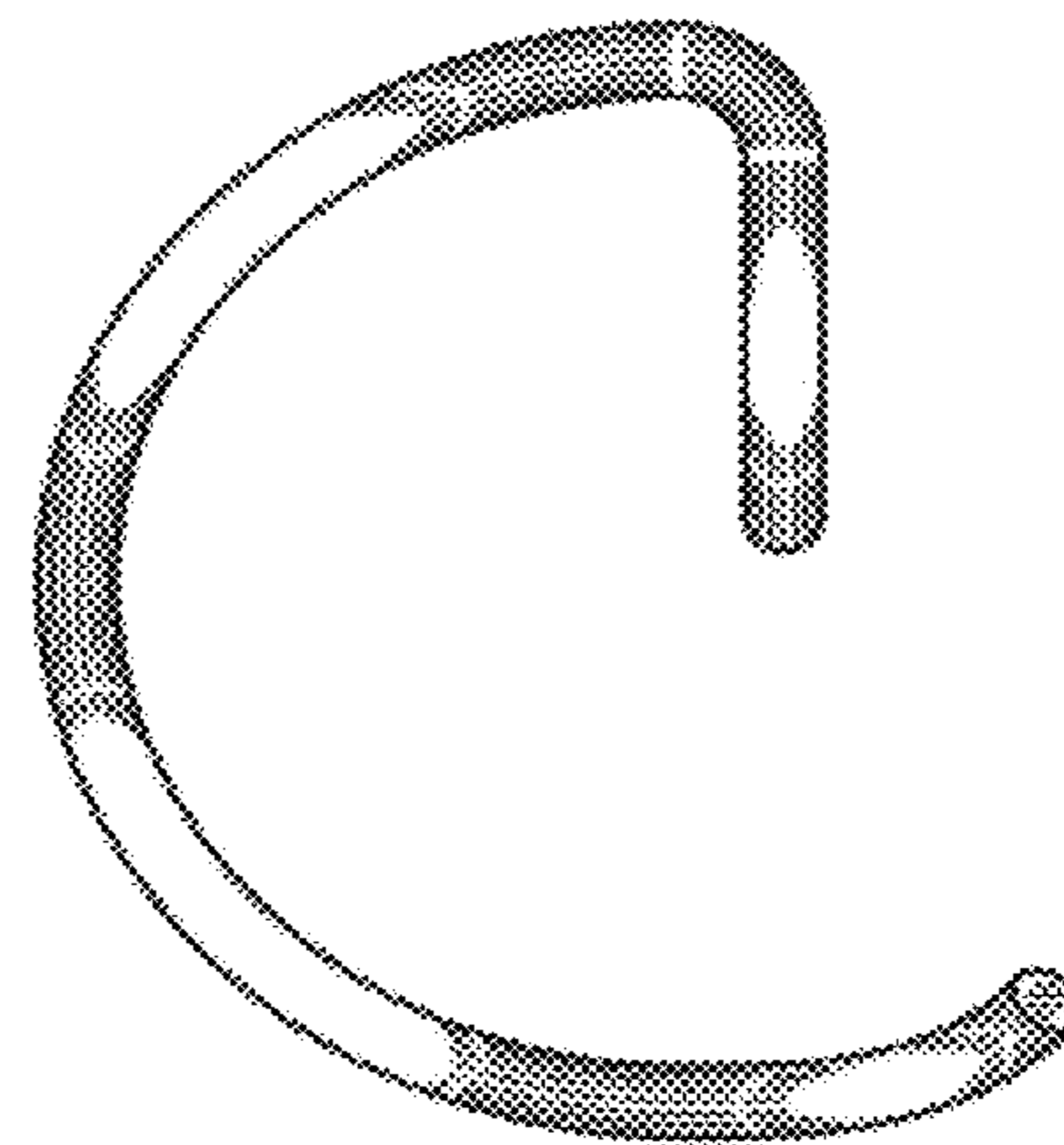

FIG. 14

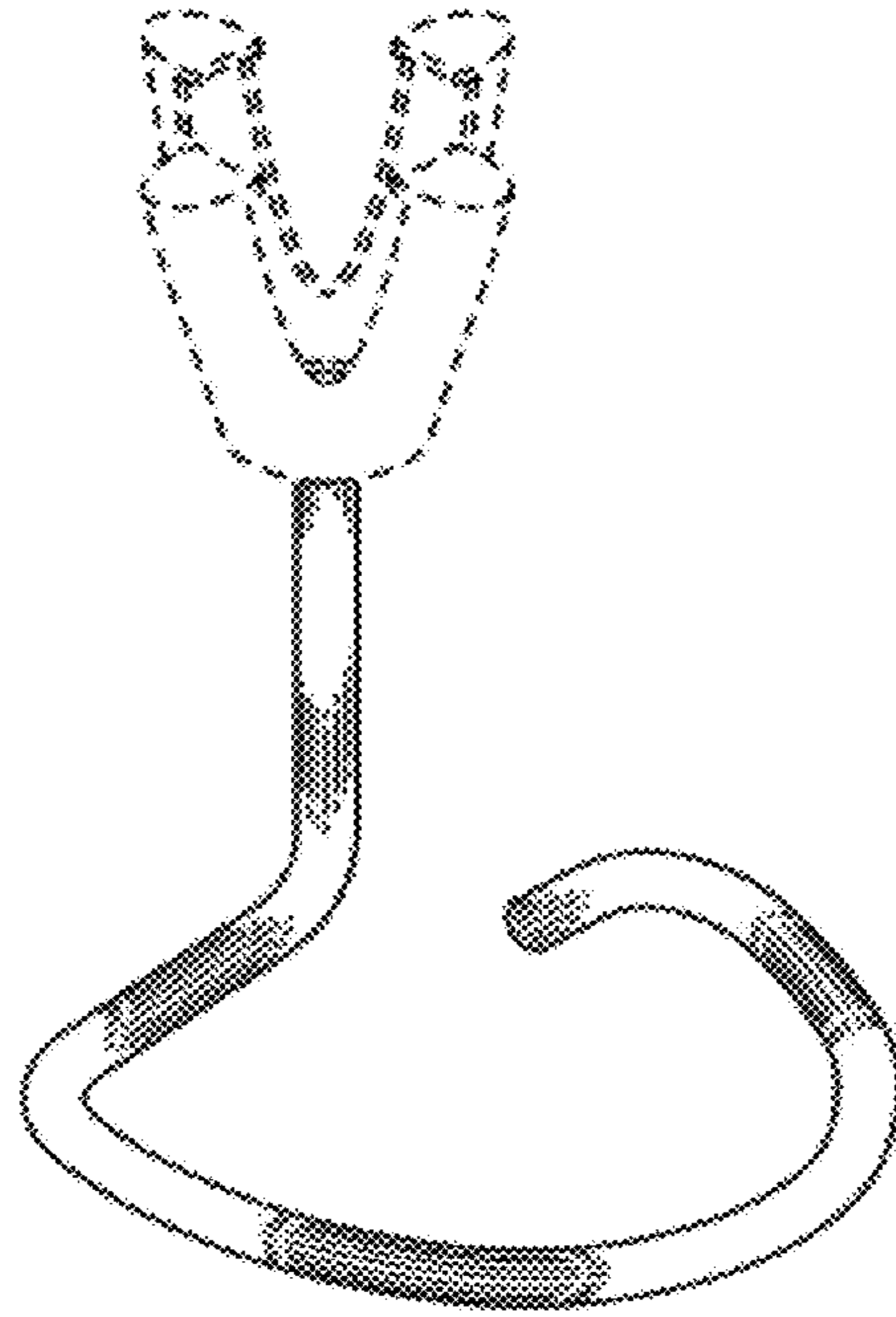

FIG. 15

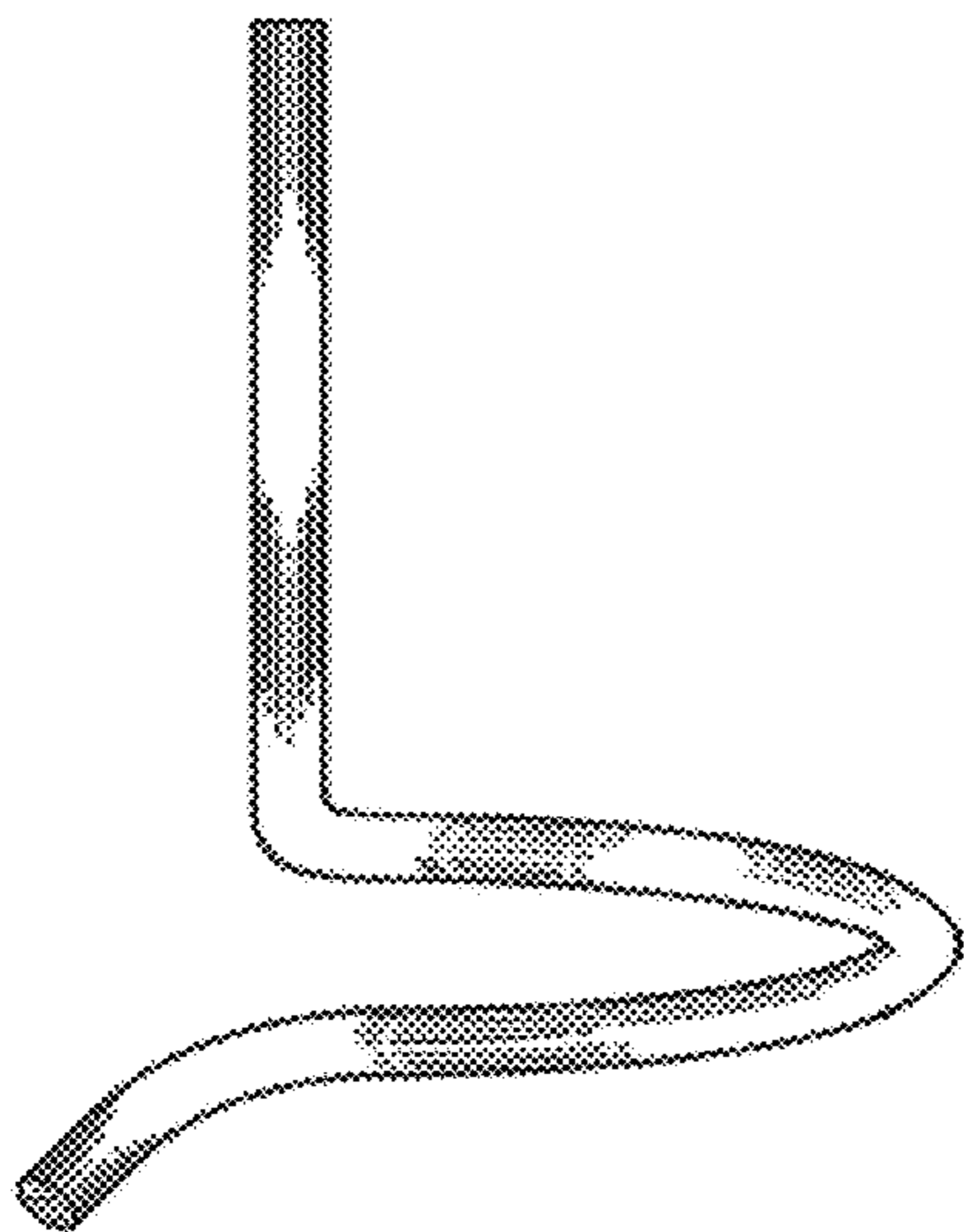

FIG. 16

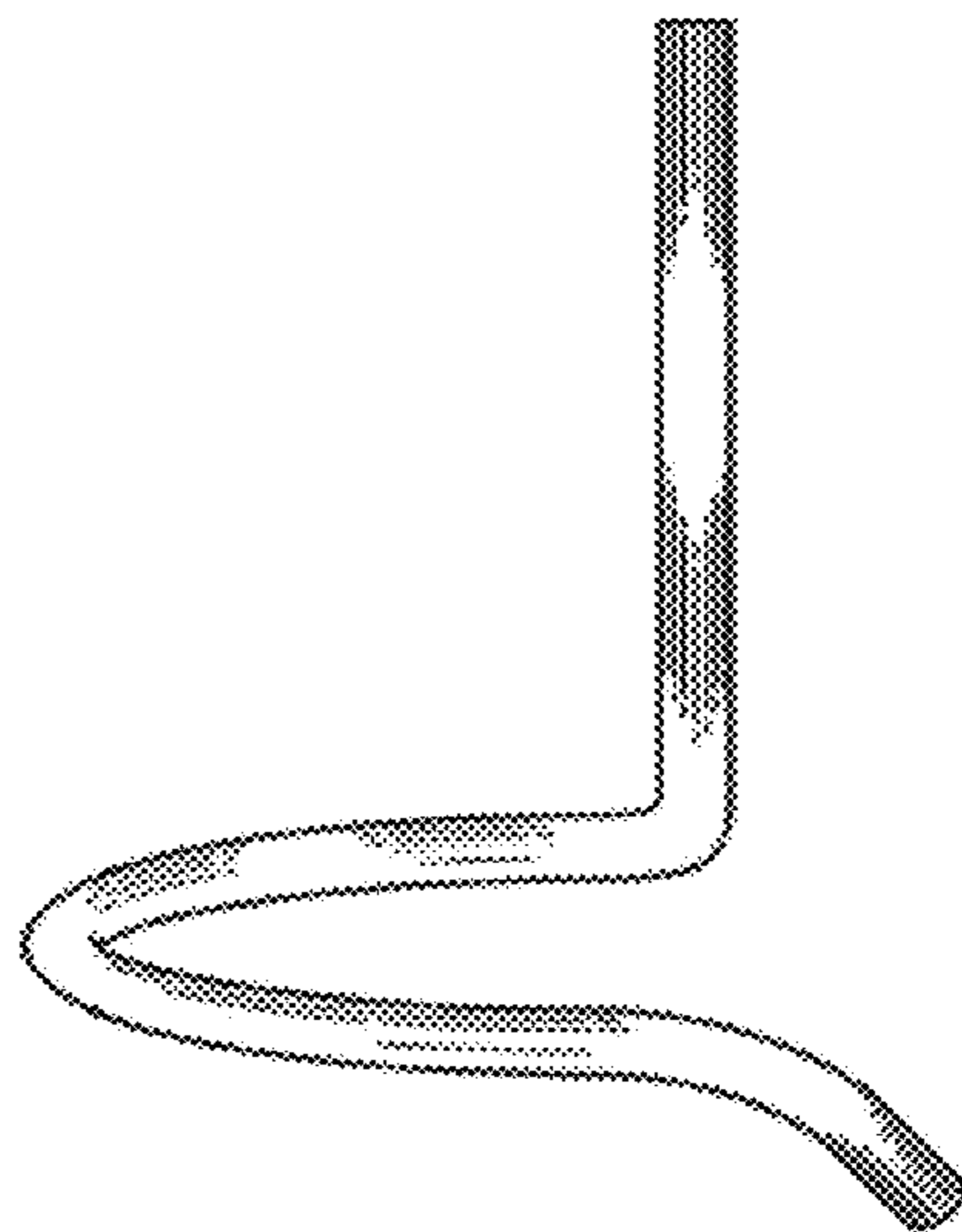

FIG. 17

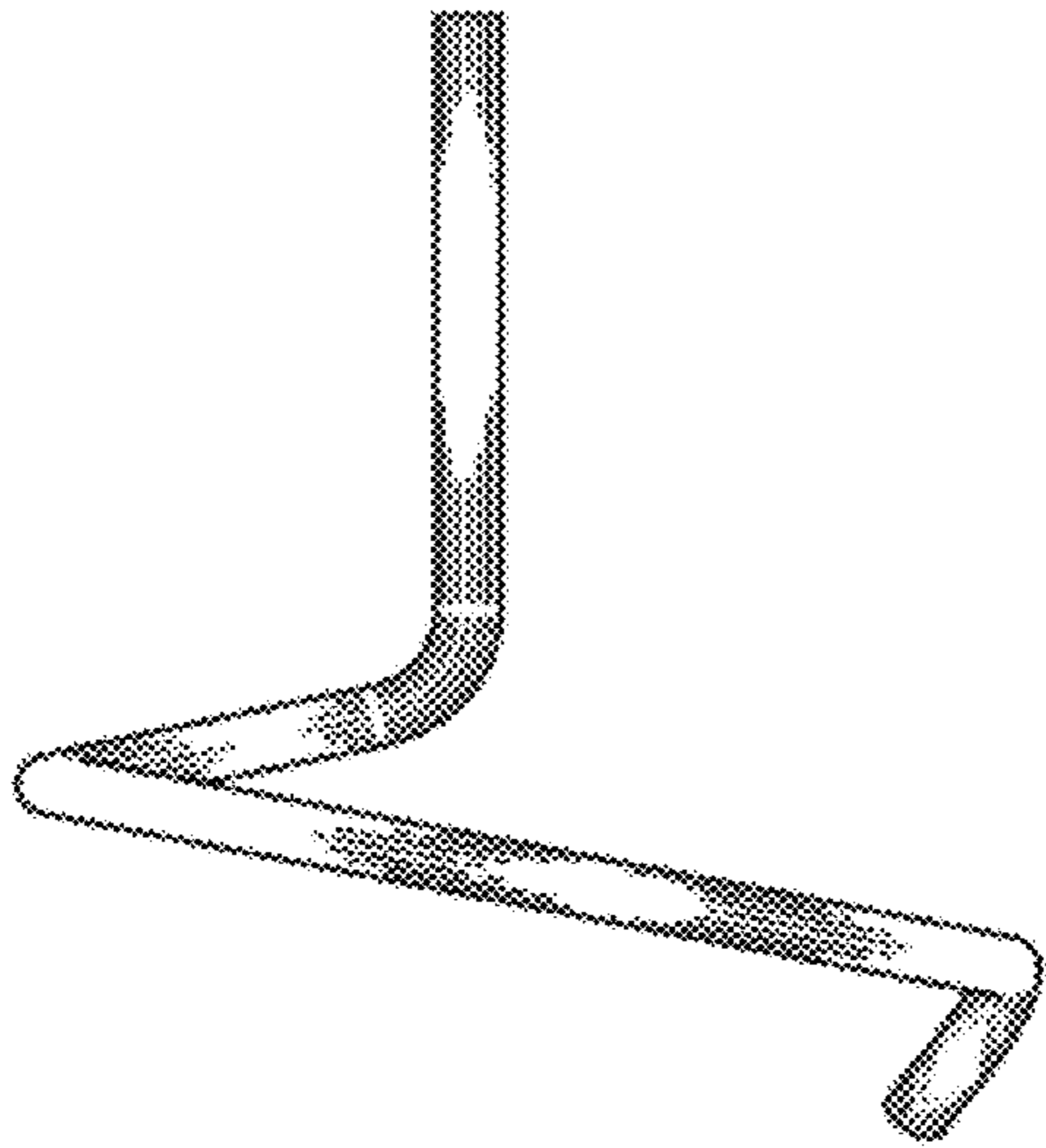

FIG. 18

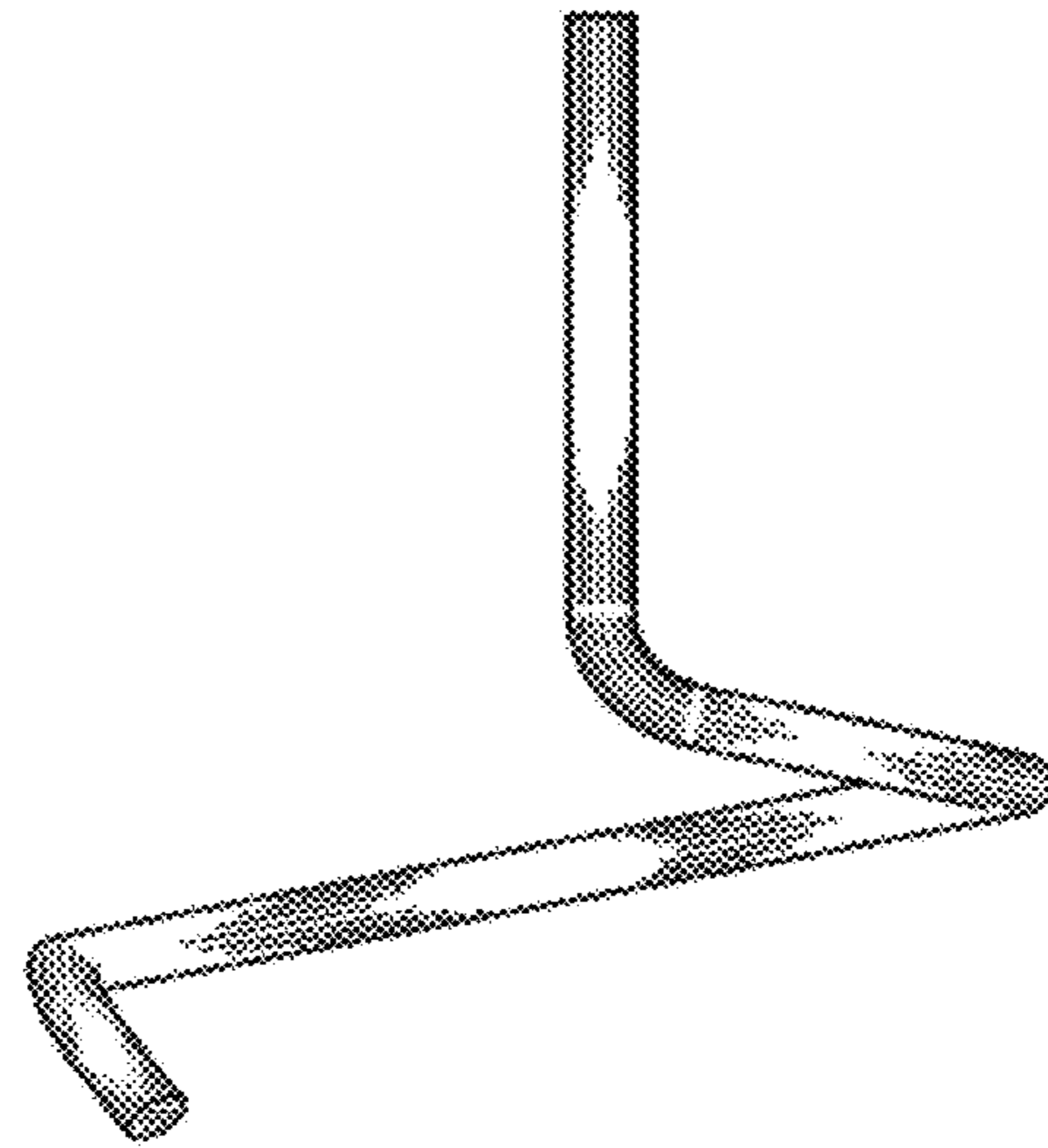

FIG. 19

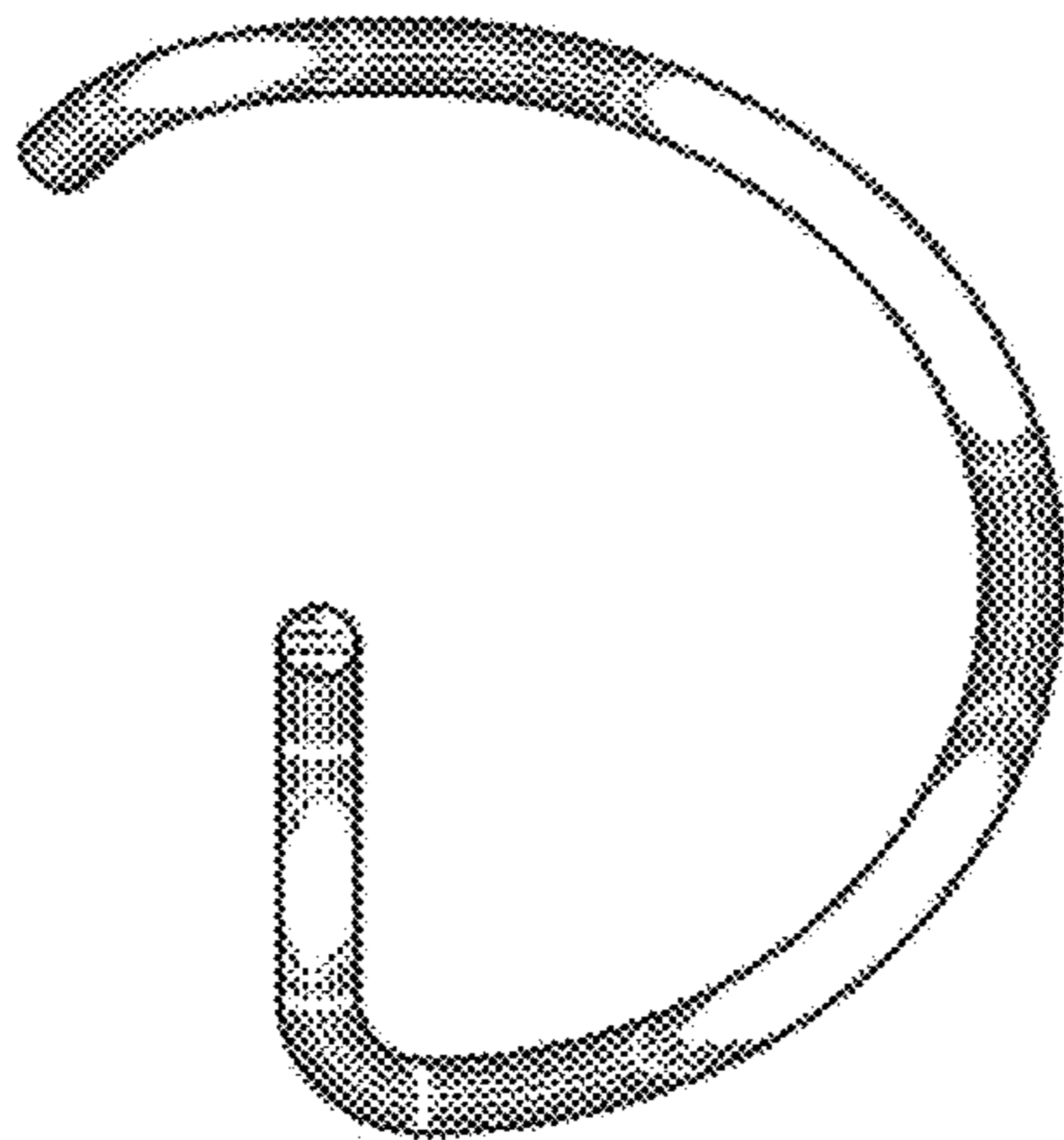

FIG. 20

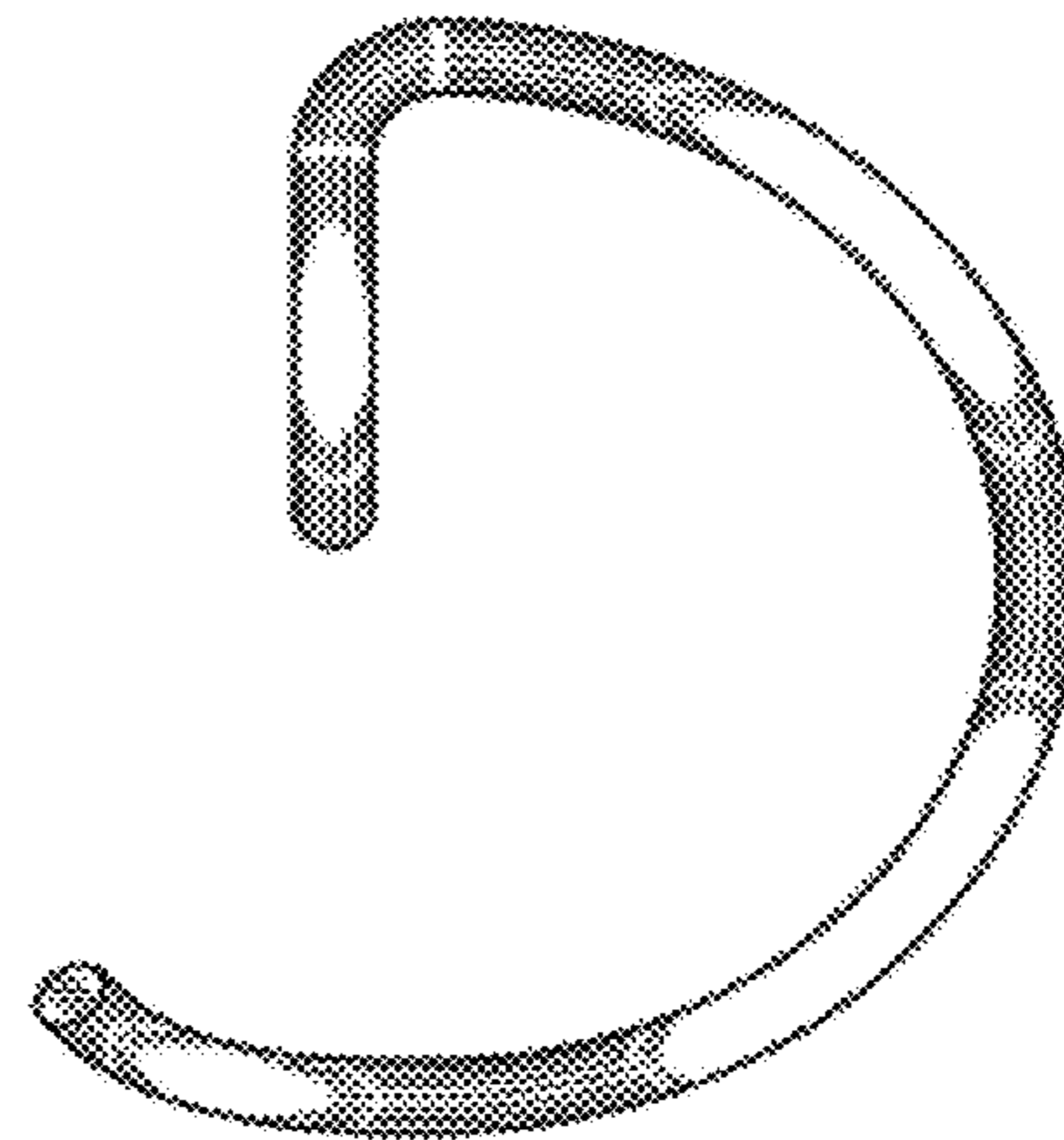

FIG. 21

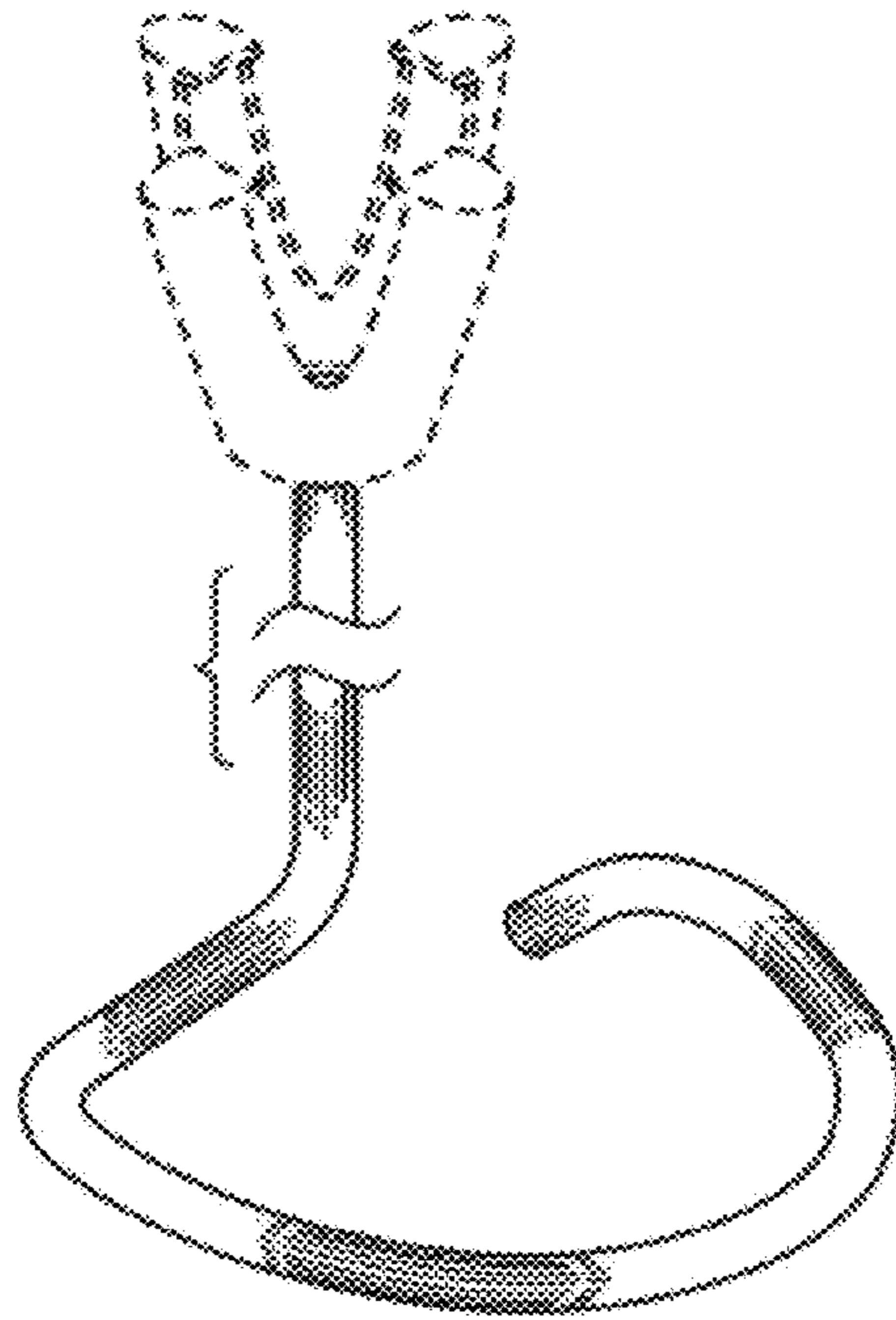

FIG. 22

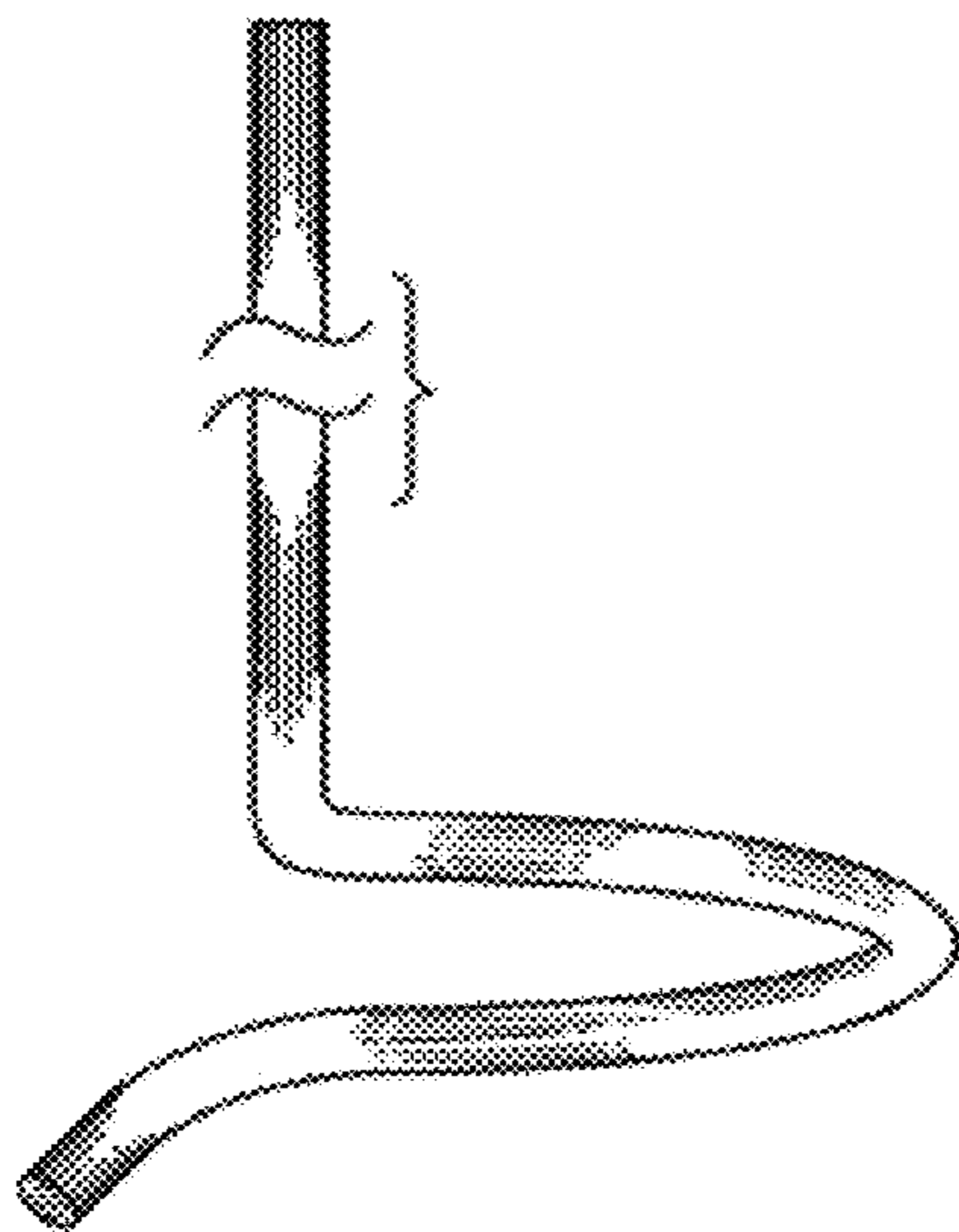

FIG. 23

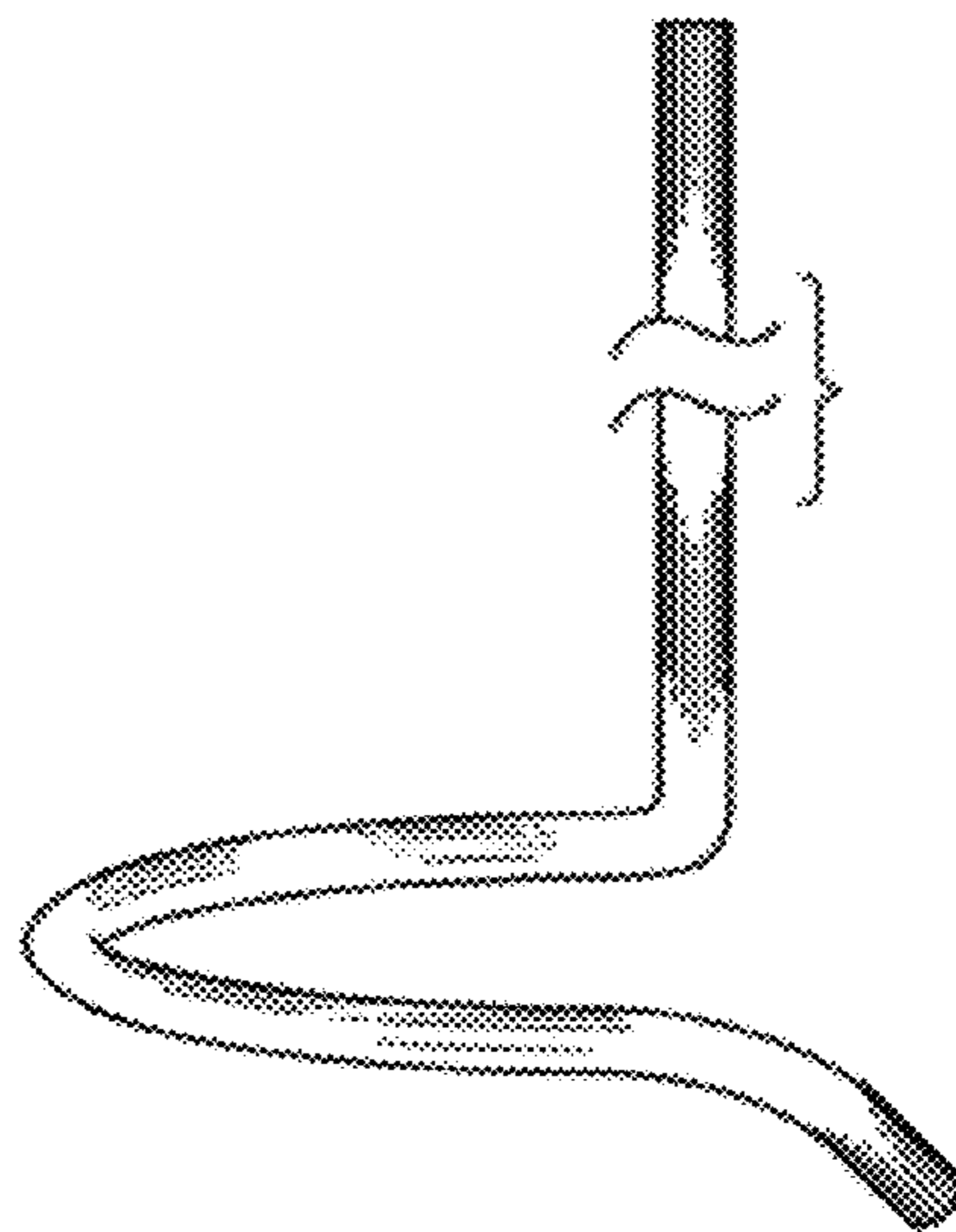

FIG. 24

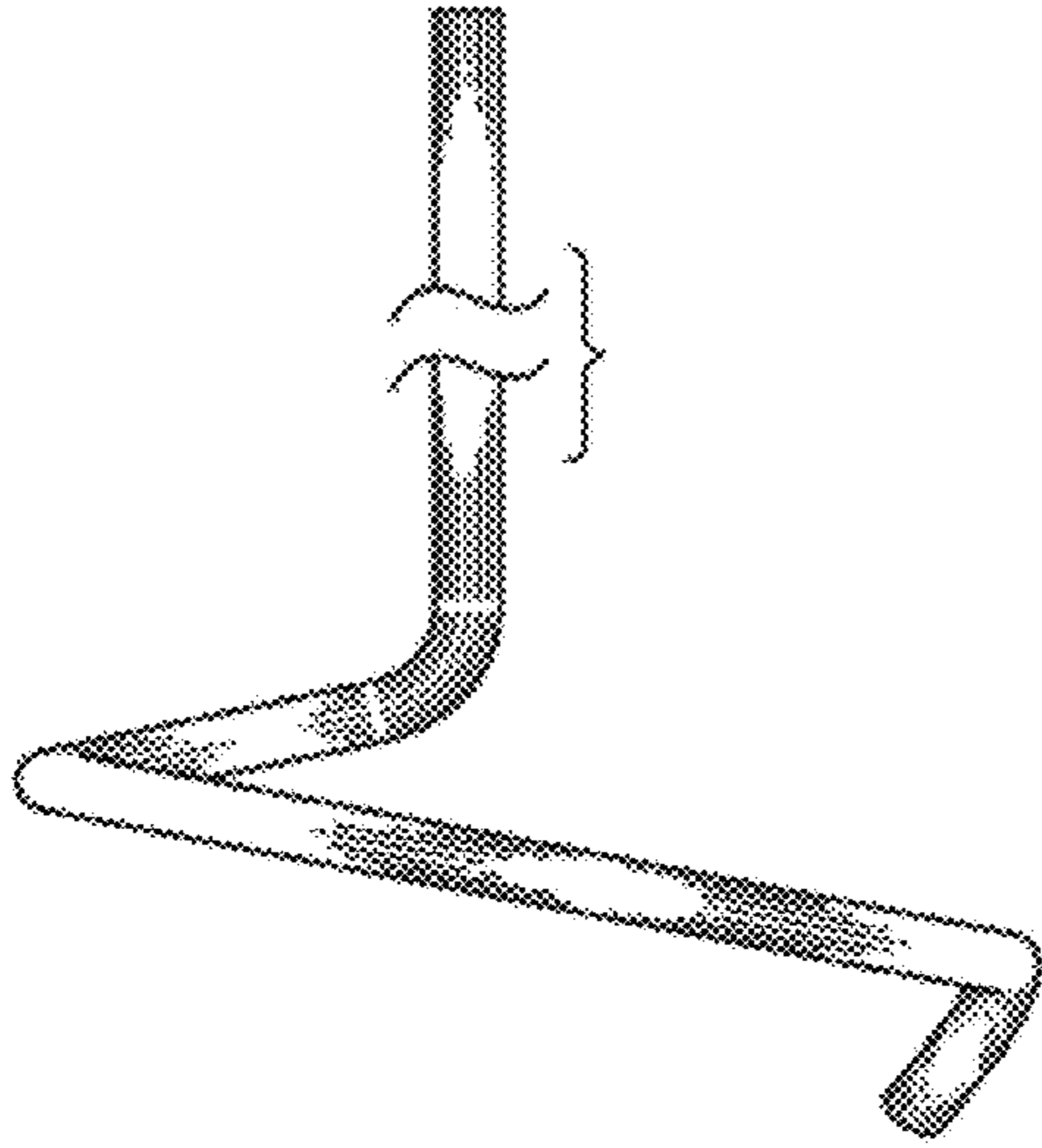

FIG. 25

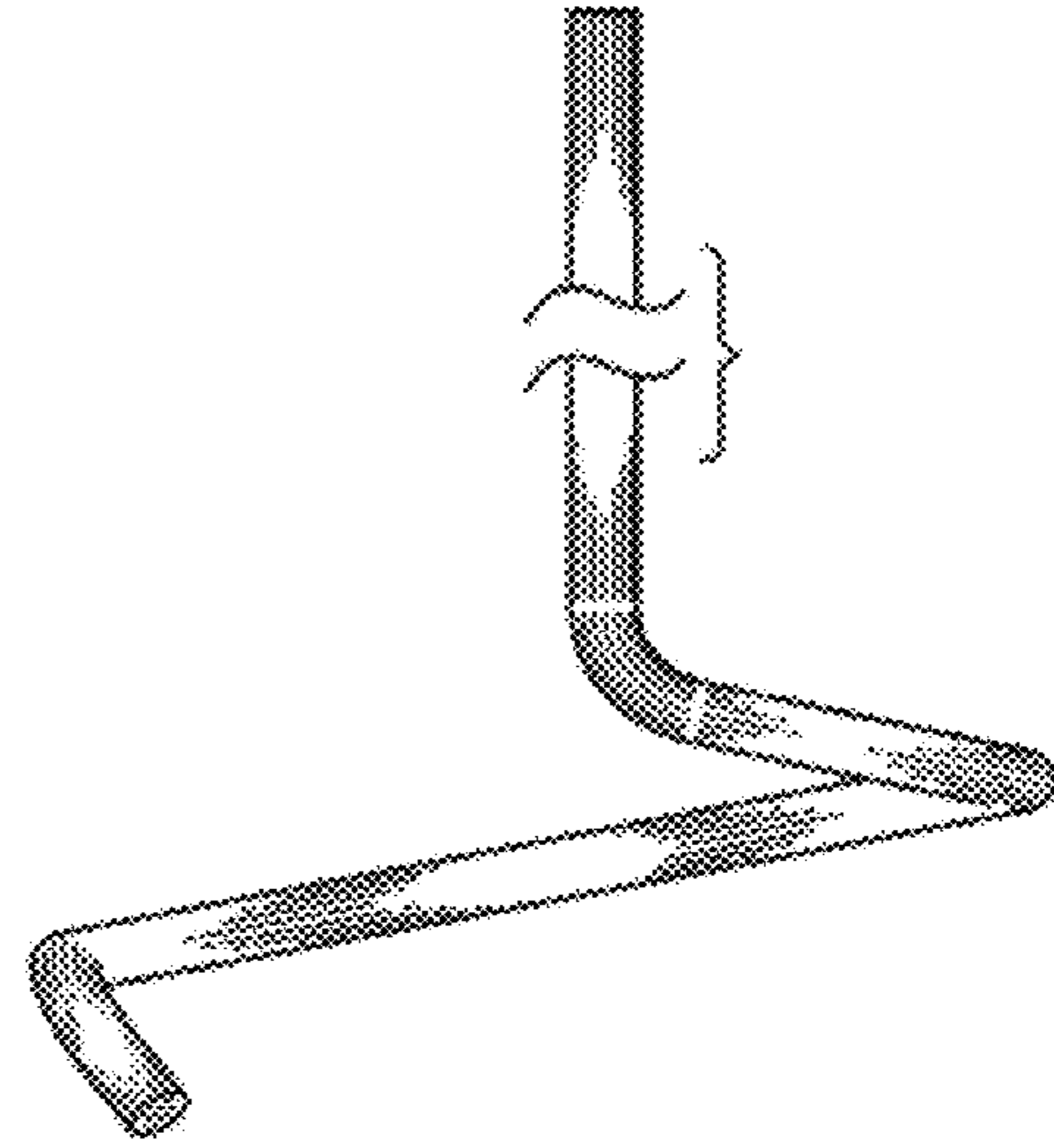

FIG. 26

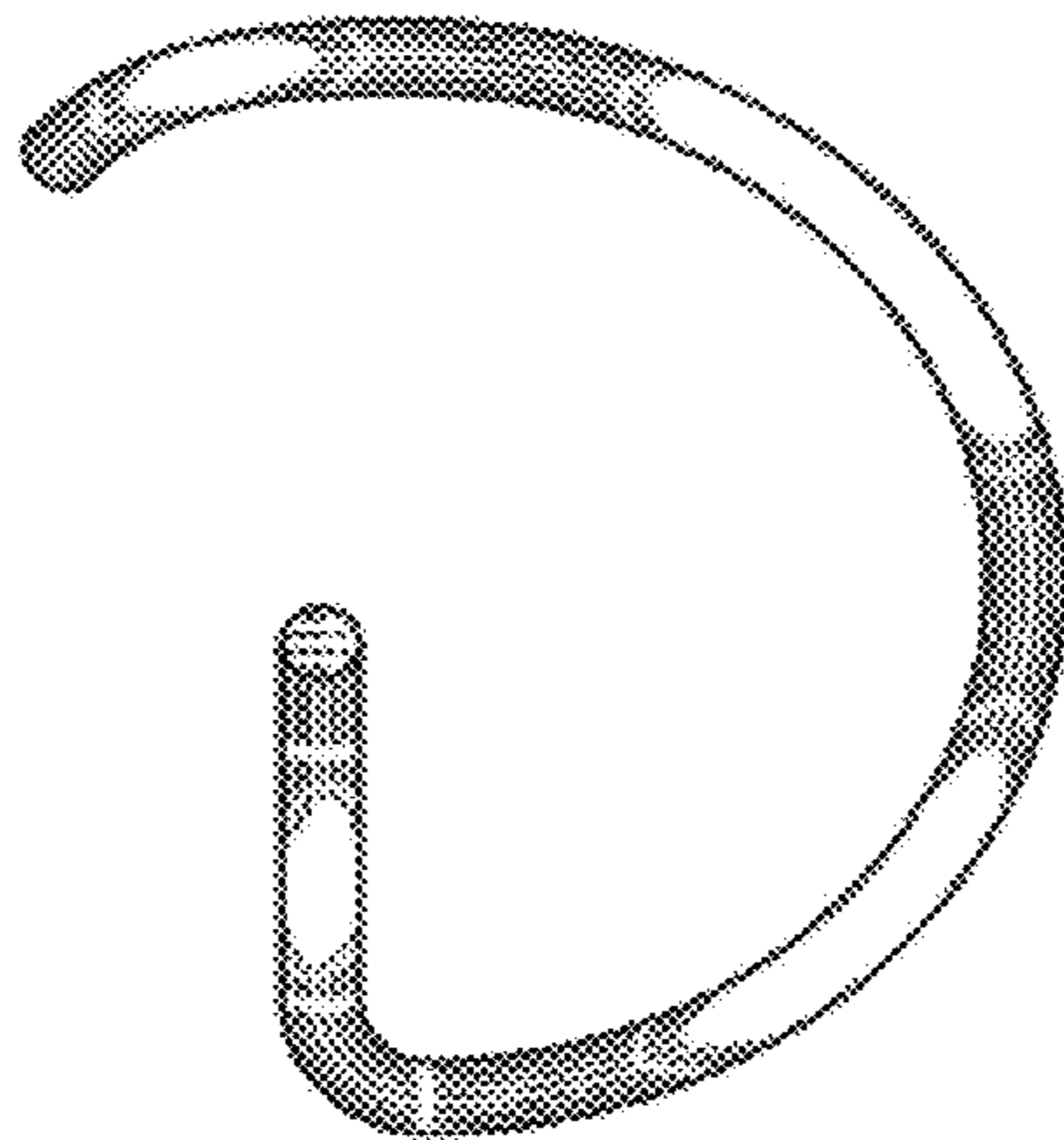

FIG. 27

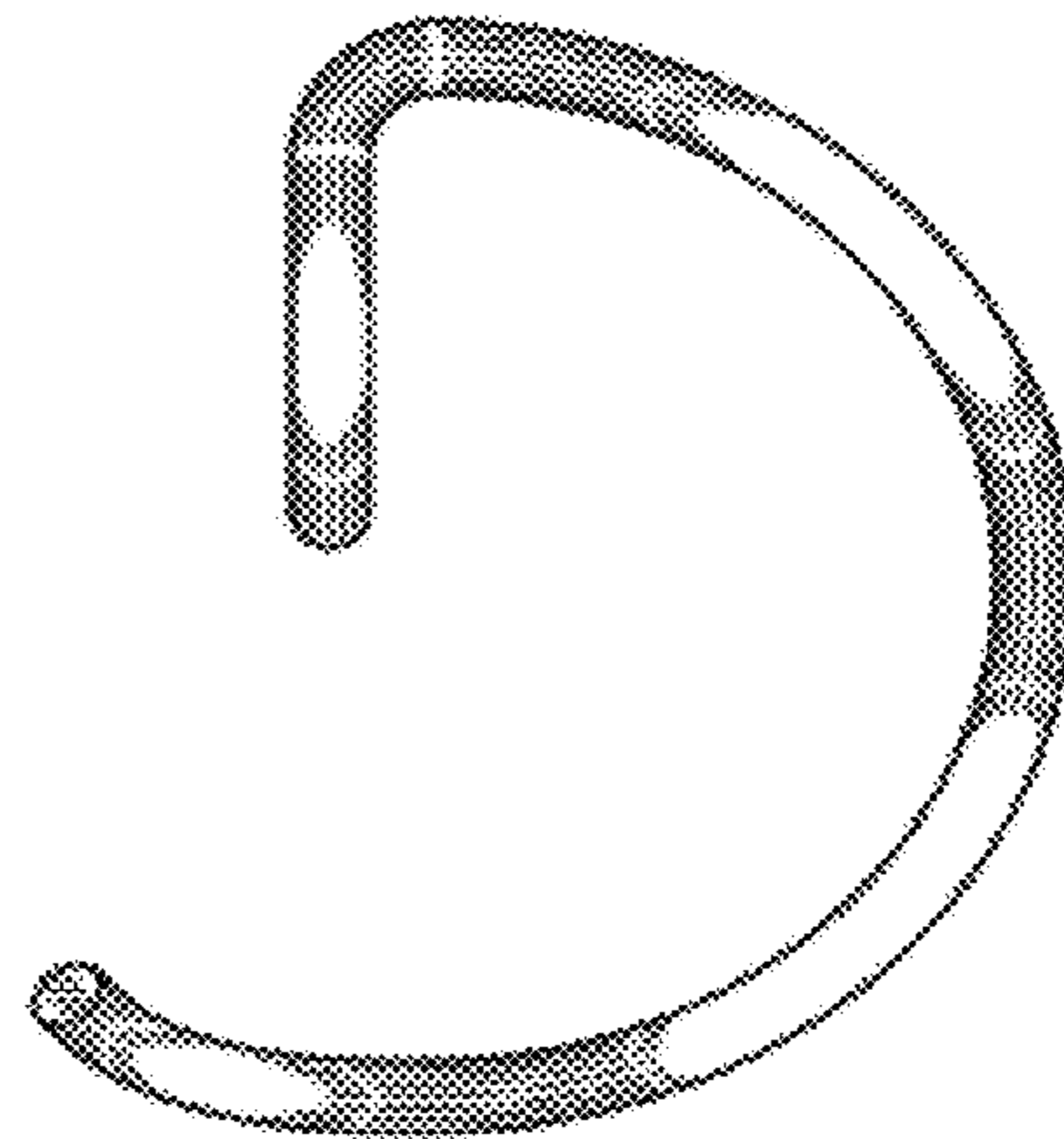

FIG. 28