



US00D684846S

(12) **United States Design Patent**  
**DePhillips**

(10) **Patent No.:** **US D684,846 S**  
(45) **Date of Patent:** **\*\* Jun. 25, 2013**

(54) **CORD RETAINER**

(71) Applicant: **Dawn DePhillips**, New York, NY (US)

(72) Inventor: **Dawn DePhillips**, New York, NY (US)

(\*\*) Term: **14 Years**

(21) Appl. No.: **29/435,094**

(22) Filed: **Oct. 19, 2012**

(51) **LOC (9) Cl.** ..... **08-05**

(52) **U.S. Cl.**  
USPC ..... **D8/356**

(58) **Field of Classification Search**  
USPC ... D8/356, 367, 354, 349, 394, 395; 248/215,  
248/339, 489; 16/87.2, 87.8; 174/68.3; 411/431;  
D13/133; 439/501; 320/111, 114  
See application file for complete search history.

(56) **References Cited**

U.S. PATENT DOCUMENTS

3,062,475	A *	11/1962	Miller, Jr.	.....	242/405.1
6,128,843	A *	10/2000	Gebka	.....	40/642.01
D549,557	S *	8/2007	Mori et al.	.....	D8/356
D556,019	S *	11/2007	Symons	.....	D8/356
D570,593	S	6/2008	Justiss		
D575,143	S *	8/2008	Kuo et al.	.....	D8/394
D591,678	S *	5/2009	Whitley et al.	.....	D13/133
7,654,484	B2 *	2/2010	Mogensen et al.	.....	242/402
D620,781	S *	8/2010	Weckworth	.....	D8/356
D629,671	S *	12/2010	Ohori et al.	.....	D8/356

D631,730	S *	2/2011	Skillman	.....	D8/356
D647,519	S	10/2011	Rothbaum et al.		
D649,017	S *	11/2011	Stieler	.....	D8/356
2002/0145073	A1 *	10/2002	Swanson et al.	.....	242/588.3
2003/0122023	A1 *	7/2003	Pitcher	.....	242/388.1
2007/0099681	A1	5/2007	Kielland		
2007/0165371	A1	7/2007	Brandenburg		
2011/0192857	A1	8/2011	Rothbaum et al.		
2011/0253571	A1	10/2011	Rothbaum		

\* cited by examiner

*Primary Examiner* — Cynthia Underwood  
(74) *Attorney, Agent, or Firm* — Goldstein Law Offices, P.C.

(57) **CLAIM**

The ornamental design for a cord retainer, as shown and described.

**DESCRIPTION**

FIG. 1 is a perspective view of the cord retainer;  
FIG. 2 is a front elevational view of the cord retainer.  
FIG. 3 is a rear elevation thereof with the broken lines forming a portion of the structure that forms no part of the claim;  
FIG. 4 is a right side view thereof.  
FIG. 5 is a left side elevational view thereof.  
FIG. 6 is a top plan view thereof.  
FIG. 7 is a bottom plan view thereof; and,  
FIG. 8 is a perspective view thereof, shown on the back of a smartphone with a pair of earbuds attached to a cord wrapped around it in broken lines representing an environment of use forming no part of the claim.

**1 Claim, 5 Drawing Sheets**

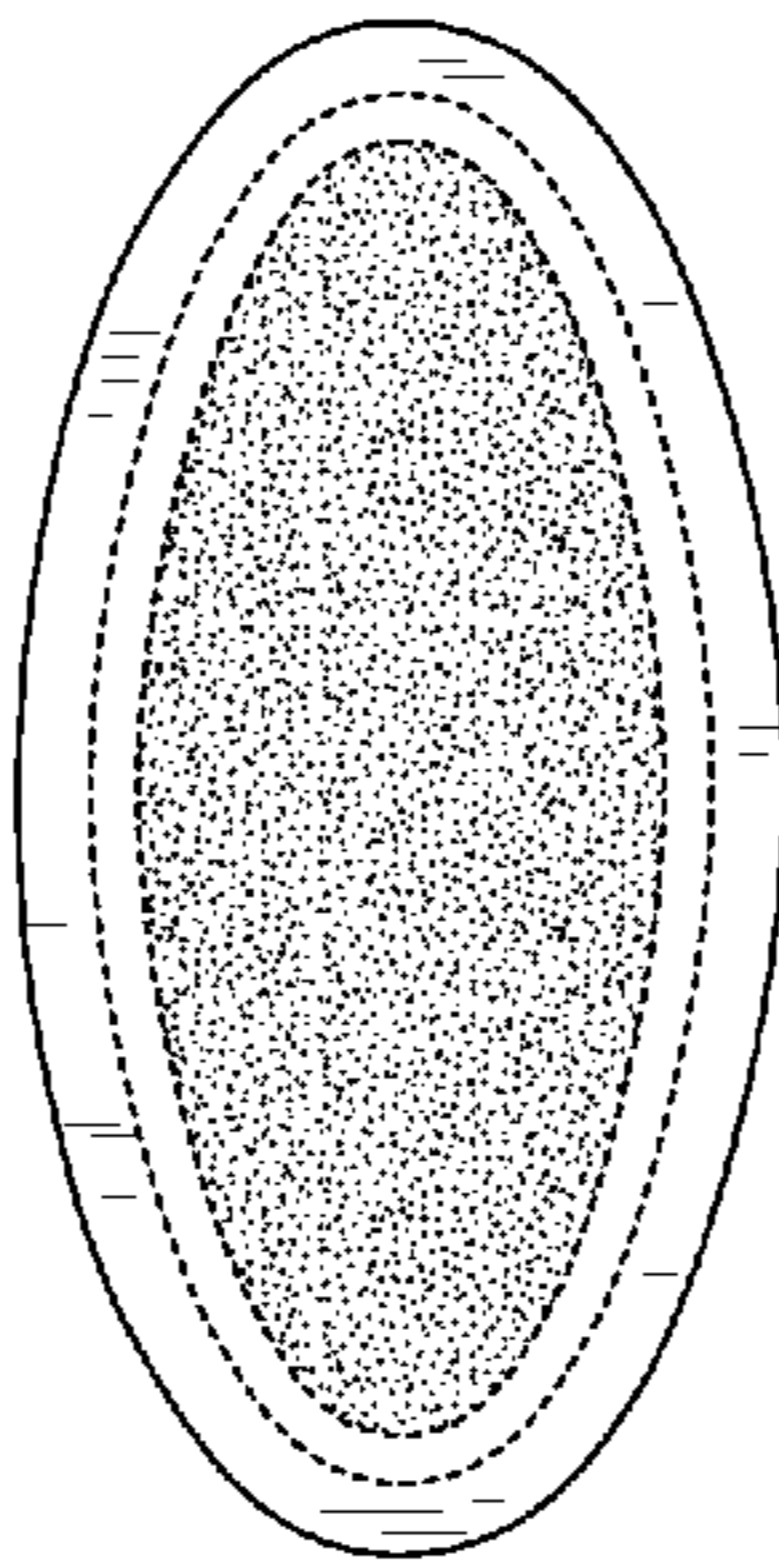
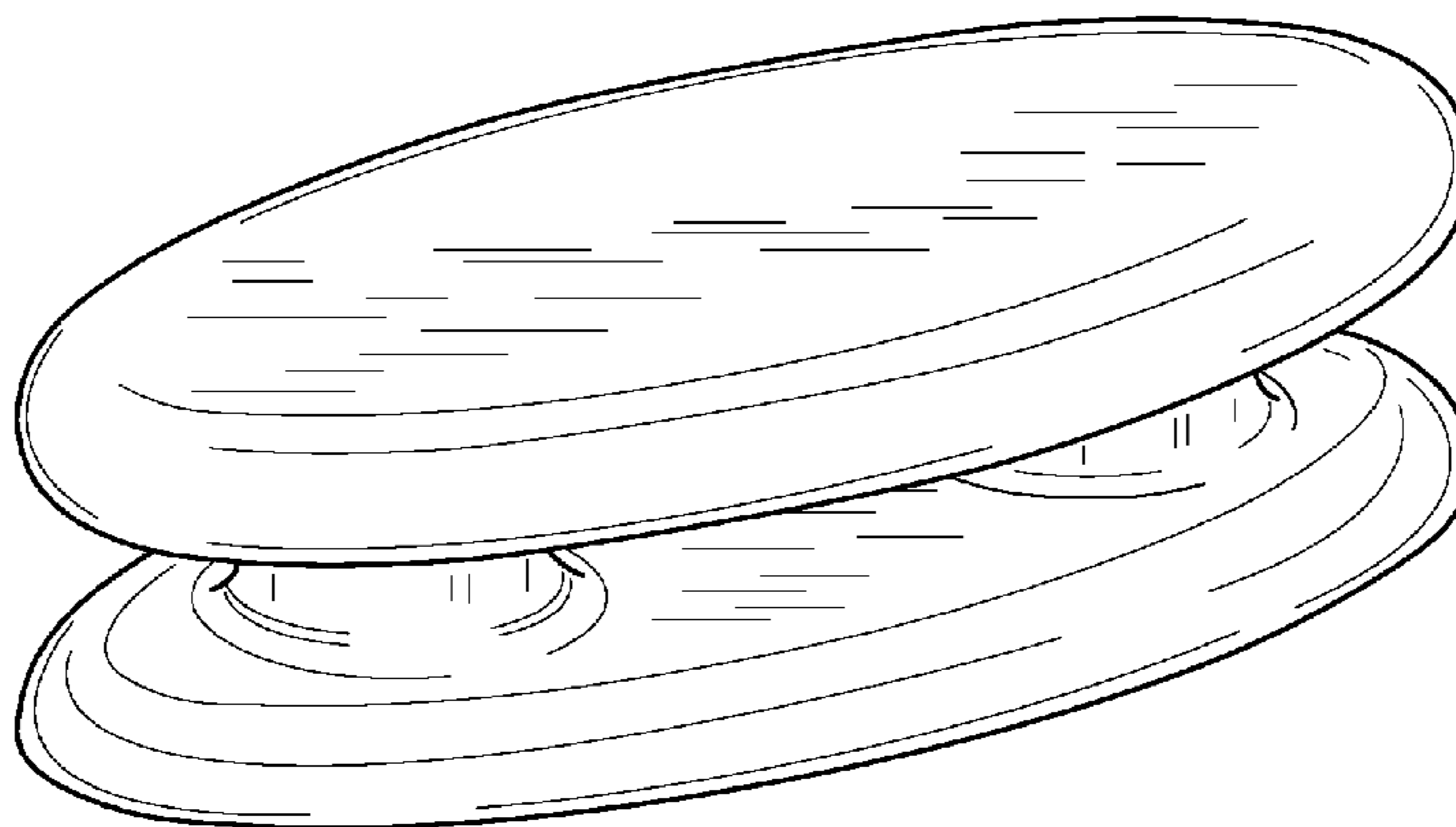

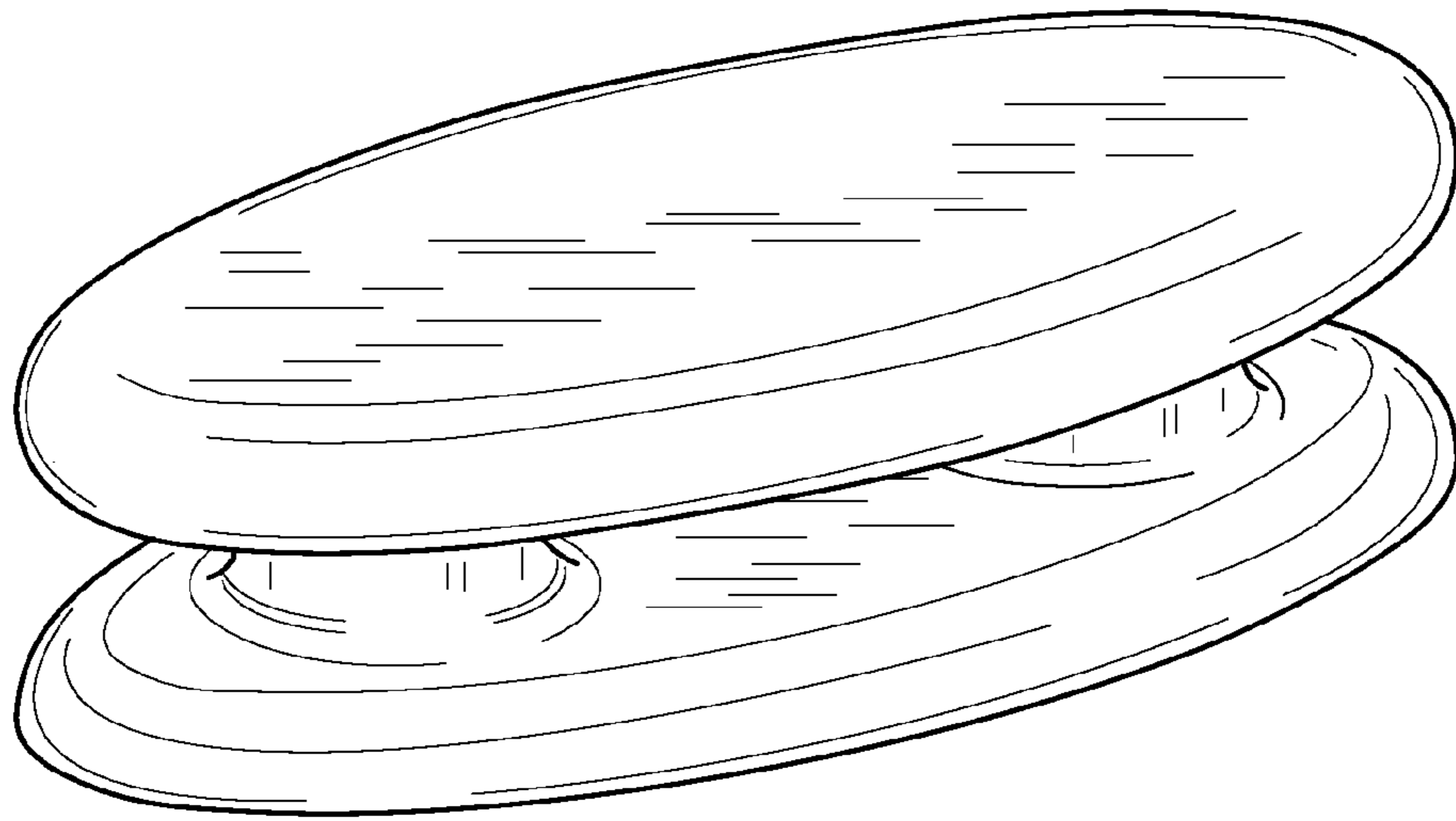

*FIG. 1*

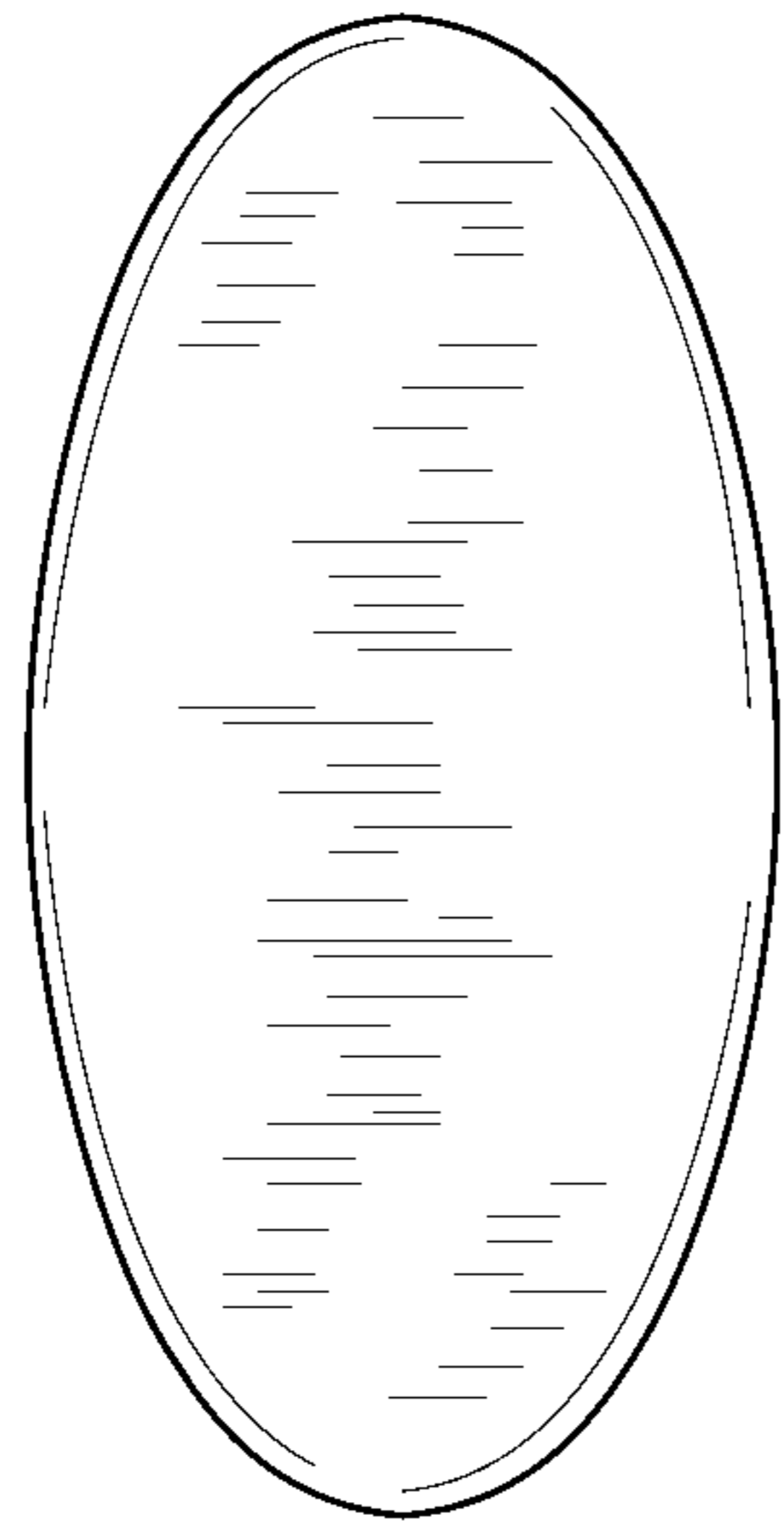

FIG. 2

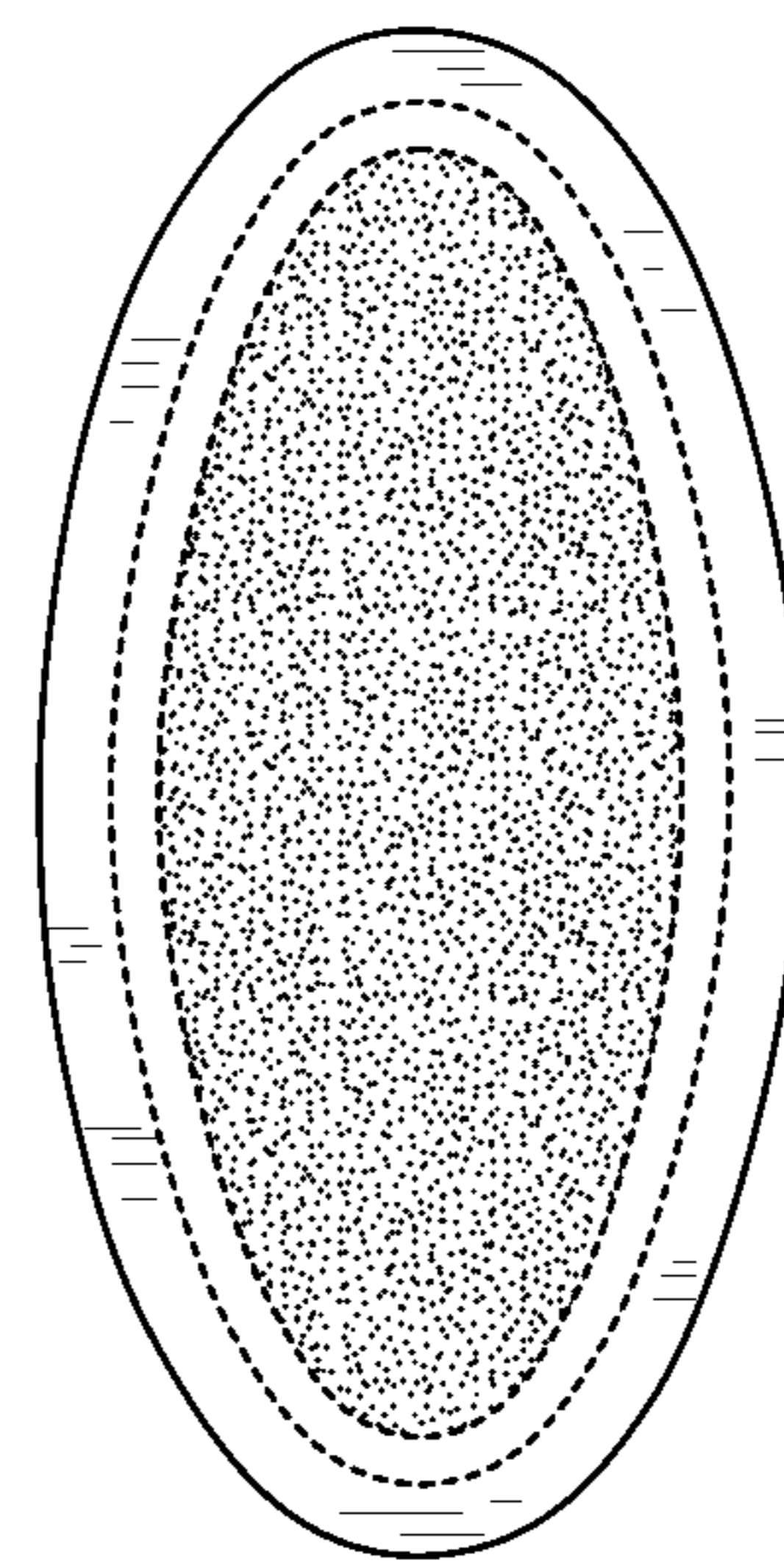

FIG. 3

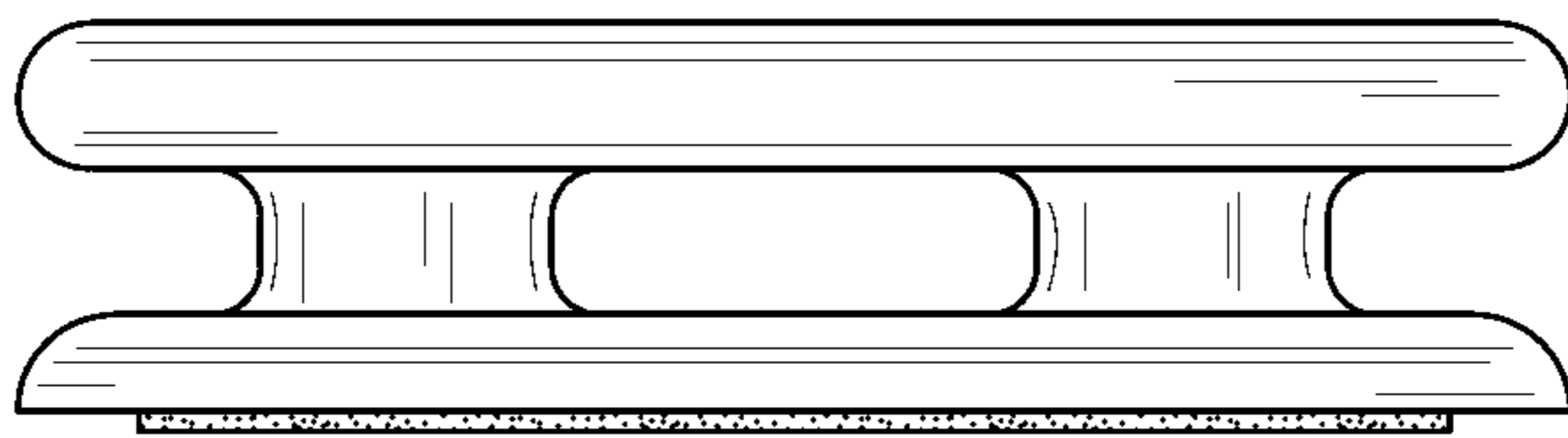

FIG. 4

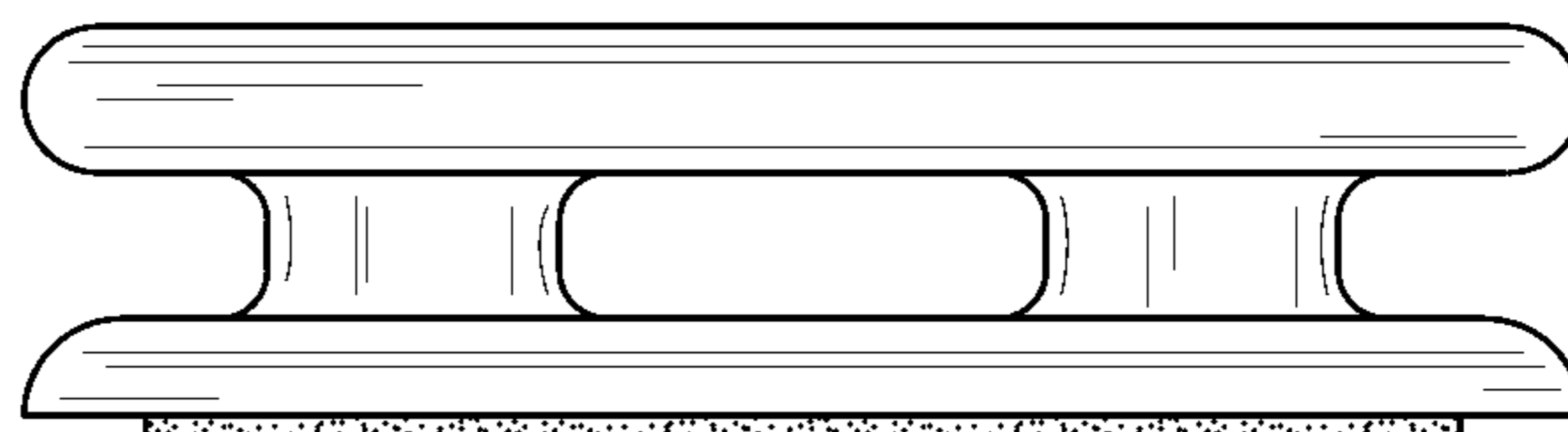
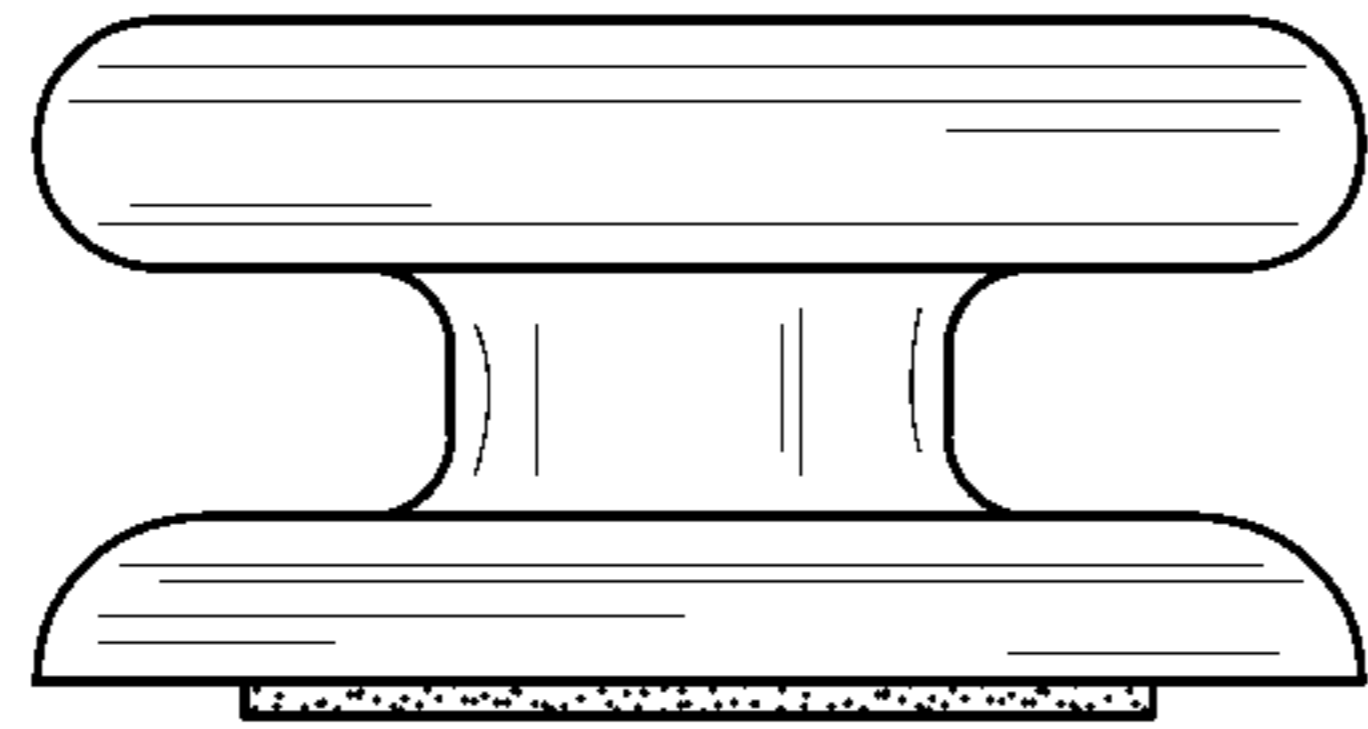
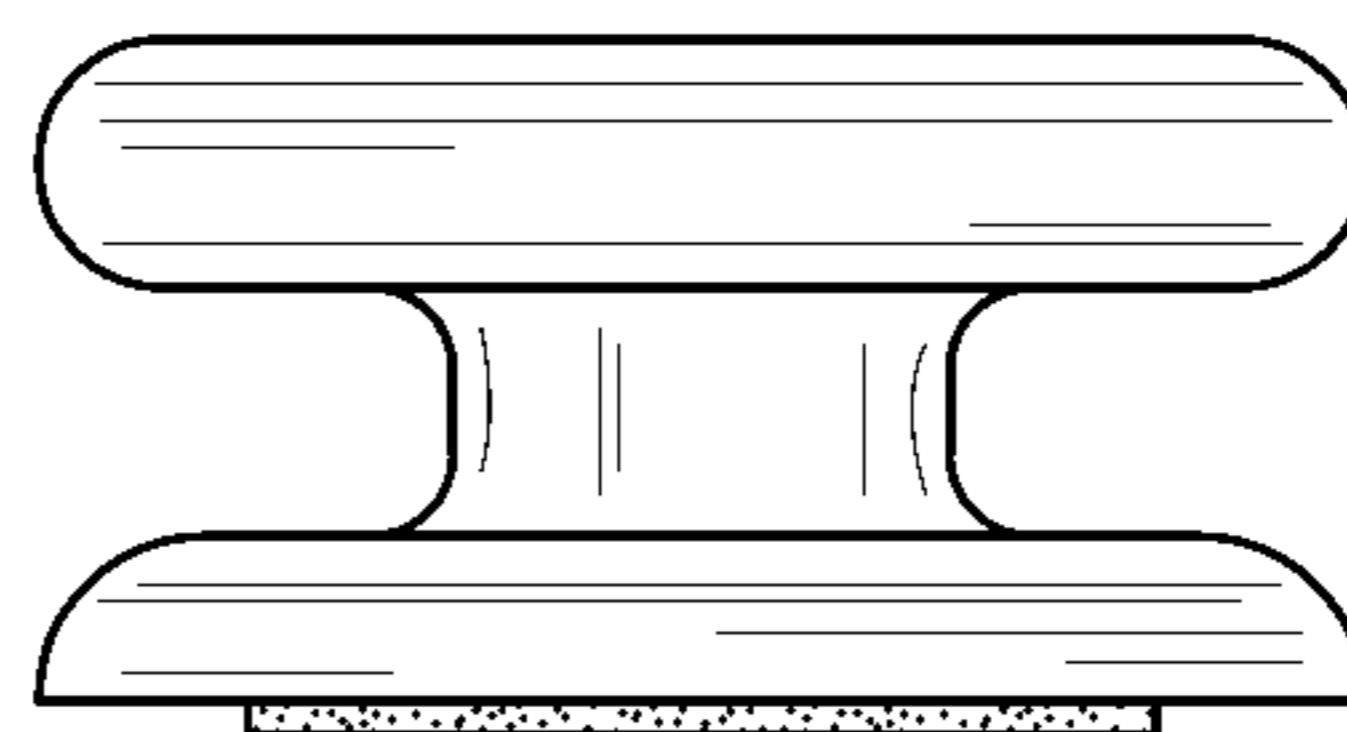

FIG. 5



*FIG. 6*



*FIG. 7*

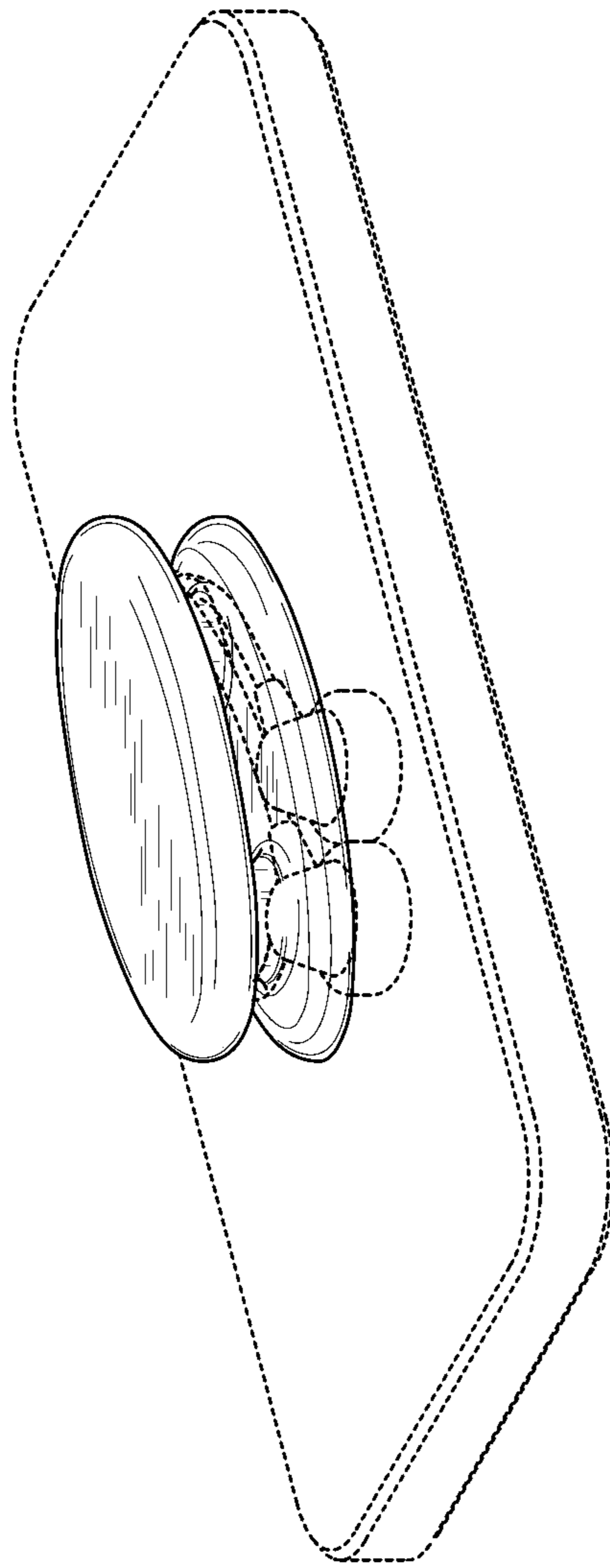

FIG. 8